



**Integra<sup>®</sup> Ruggles<sup>®</sup>-Redmond<sup>™</sup>**  
Neuro/Spine Surgical Instruments

# Introduction





**General Information**

Ordering & Warranty ..... ii  
Scales ..... iii-iv  
Instrument Measuring Guidelines ..... v-vii

**Access Instrumentation.....1**

Saws ..... 2  
Knives/Retinaculotomes ..... 5  
Dura Hooks ..... 6  
Nerve Hooks ..... 8  
Separators ..... 9  
Dissectors and Elevators ..... 10  
Osteotomes ..... 18  
Impactors ..... 20

**Retractors..... 21**

Anterior Cervical Fusion Distraction System ..... 22  
MLD System ..... 27  
UMLD System ..... 28  
Flexi-Spine™ Retraction System ..... 30  
Ruggles® Spinal Retraction System ..... 32  
LumbarTrak™ Retractor System ..... 34  
Spetzler Sonntag Trans-Oral Retractor System ..... 38  
McCulloch Retractor System ..... 43  
Spatulas ..... 45  
Nerve Root ..... 49  
Hand-Held ..... 52  
Spreaders ..... 54  
Scalp ..... 56  
Self-Retaining ..... 57  
Traction Tongs ..... 68

**Rongeurs ..... 69**

Bone Rongeurs ..... 71  
Wire Cutters ..... 76  
Intervertebral Disc Rongeurs ..... 77  
Ultra-Coat Kerrison Rongeurs ..... 89  
Diamond Kerrison Rongeurs ..... 95  
Stealth Kerrison Rongeurs ..... 98  
Micro Kerrisons Rongeurs ..... 103

Spurling Kerrison Rongeurs ..... 106  
Ferris-Smith Kerrisons Rongeurs ..... 109

**Curettes.....111**

Ultra-Coat™ Curettes ..... 112  
Spinal Fusion Curettes ..... 114  
Bone Curettes ..... 119  
Microsurgical Curettes ..... 120  
Sisco Curettes ..... 123  
Cervical Bayonet Curettes ..... 124  
Lumbar Bayonet Curettes ..... 126

**Suction Tubes .....127**

Frazier Suction Tubes ..... 128  
Poppen Suction Tubes ..... 131  
Multi-Hole Suction Tubes ..... 132  
Endonasal Suction Tubes ..... 135  
Atraumatic Tubes ..... 133  
Tapered Teardrop Suction Tubes ..... 136

**Microsurgical Instrumentation ..... 139**

Micro Dissection ..... 140  
Micro Titanium ..... 161  
Micro Hooks ..... 162  
Micro Forceps ..... 166  
Bipolar Forceps ..... 170  
Micro Scissors ..... 183  
Micro Needle Holders ..... 191  
Ring Handled Forceps and Scissors ..... 195  
Speculums ..... 199  
Transphenoidal ..... 200  
Endonasal ..... 203

**Indexes ..... 205**

Alphabetical Index ..... 206  
Numerical Index ..... 215

**Pricing:**

Prices stated in specific written quotations are firm for thirty days from the date given, and are otherwise subject to change without prior notice. Pricing terms stated on written agreements are governed by such agreements.

**Shipments:**

F.O.B. Integra LifeSciences point of shipment within the continental United States. Shipping costs (including freight and insurance), shall be prepaid by Integra LifeSciences and invoiced to customers.

**Ordering Procedure:**

A written purchase order on customer's form may be requested for purchases of Integra LifeSciences products.

**Acceptance of Orders:**

Orders are accepted upon approval by Integra LifeSciences.

**Return Policy:**

- Authorization, from customer service, must be obtained prior to returning product within 90 days of receipt of product.
- Sterile product must be returned in unopened, undamaged cartons, packed to prevent damage.
- Non-sterile product must be returned in unused saleable condition in original package.
- Credit will be issued for goods returned prior to ninety days from ship date with a 20% restocking charge. This assumes that the product returned is not damaged and can be verified to have not been used or opened.

For Product Instructions for Use, please visit [integralife.com/jarit](http://integralife.com/jarit)



Miltex GmbH  
78604 Rietheim-Weilheim, Germany

**Integra Standard Warranty**

INTEGRA LIFESCIENCES CORPORATION ("INTEGRA") warrants to the original purchaser only that each new INTEGRA product is free from manufacturing defects in material and workmanship under normal use and service for a period of two (2) years (except as otherwise expressly provided as to accessory items) from the date of delivery by INTEGRA to the first purchaser, but in no event beyond the expiration date stated on any product labeling.

Surgical instruments are guaranteed to be free from defects in material and workmanship when maintained and cleaned properly and used normally for their intended purpose.







Any covered product that is placed by INTEGRA under a lease, rental or installment purchase agreement and that requires repair service during the term of such placement agreement shall be repaired in accordance with the terms of such agreement.







If any covered defect occurs during the warranty period or term of such placement agreement, the purchaser should communicate directly with INTEGRA's home office. If purchaser seeks to invoke the terms of this warranty, the product must be returned to INTEGRA at its home office. The defective product should be returned promptly, properly packaged and postage prepaid. Loss or damage in return shipment to INTEGRA shall be at CUSTOMER's risk. INTEGRA's sole responsibility under this warranty shall be repair or replacement, at INTEGRA's sole discretion at INTEGRA's expense, subject to the terms of this warranty and applicable agreements IN NO EVENT SHALL INTEGRA BE LIABLE FOR ANY INCIDENTAL, INDIRECT, CONSEQUENTIAL OR PUNITIVE DAMAGES IN CONNECTION WITH THE ACQUISITION OR USE OF ANY INTEGRA PRODUCT. Further, this warranty shall not apply to, and INTEGRA shall not be responsible for, any loss arising in connection with the purchase or use of any INTEGRA product that has been repaired by anyone other than an authorized INTEGRA service representative or altered in any way so as, in INTEGRA's judgment, to affect its stability or reliability, or which has been subject to misuse, negligence or accident, or which has been used otherwise than in accordance with the instructions furnished by INTEGRA. THIS LIMITED WARRANTY IS EXCLUSIVE AND IN LIEU OF ALL OTHER WARRANTIES, EXPRESS OR IMPLIED, AND OF ALL OTHER OBLIGATIONS OR LIABILITIES ON INTEGRA'S PART, AND INTEGRA NEITHER ASSUMES NOR AUTHORIZES ANY REPRESENTATIVE OR OTHER PERSON TO ASSUME FOR IT ANY OTHER LIABILITY IN CONNECTION WITH INTEGRA'S PRODUCTS.







INTEGRA DISCLAIMS ALL OTHER WARRANTIES, EXPRESS OR IMPLIED INCLUDING ANY IMPLIED WARRANTY OF MERCHANTABILITY OR OF FITNESS FOR A PARTICULAR PURPOSE OR APPLICATION OR WARRANTY OF QUALITY AS WELL AS ANY EXPRESS OR IMPLIED WARRANTY TO PATIENTS. No warranty or guarantee may be created by any act or statement nor may this Standard Warranty be modified in any way, except as a result of a writing signed by an officer of INTEGRA. These limitations on the creation or modification of this warranty may not be waived or modified orally or by any conduct.





## French Catheter Scale

(measured by outside diameter)

3Fr	4Fr	5Fr	6Fr	7Fr	8Fr	9Fr
						
1mm	1.40mm	1.7mm	2mm	2.3mm	2.7mm	3mm
.039"	.053"	.066"	.079"	.092"	.105"	.118"

10Fr	11Fr	12Fr	13Fr	14Fr	15Fr	16Fr
						
3.3mm	3.7mm	4mm	4.3mm	4.7mm	5mm	5.3mm
.131"	.144"	.158"	.170"	.184"	.197"	.210"

17Fr	18Fr	19Fr	20Fr	22Fr	24Fr	26Fr
						
5.7mm	6mm	6.3mm	6.7mm	7.3mm	8mm	8.7mm
.223"	.236"	.249"	.263"	.288"	.315"	.341"

28Fr	30Fr	32Fr	34Fr
			
9.3mm	10mm	10.7mm	11.3mm
.367"	.393"	.419"	.445"

Tolerances in the product specifications, due to hand craftsmanship of the instrument, are subject to minor variations in dimensions and finishes.

### IVD Rongeurs • Cup Size

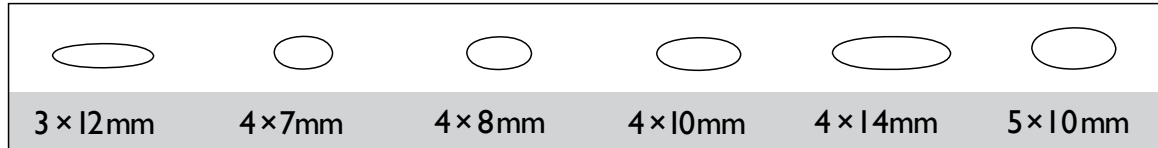
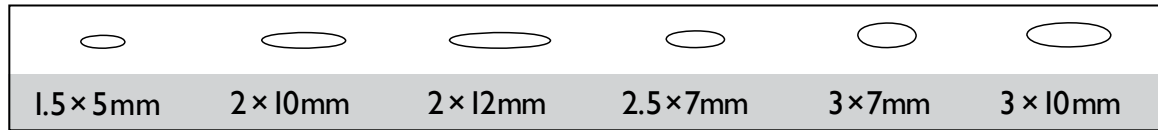

### Kerrison Rongeurs • Bite Size

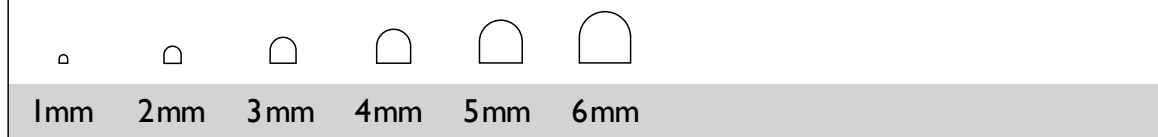

### Kerrison Rongeur Cutting Angles

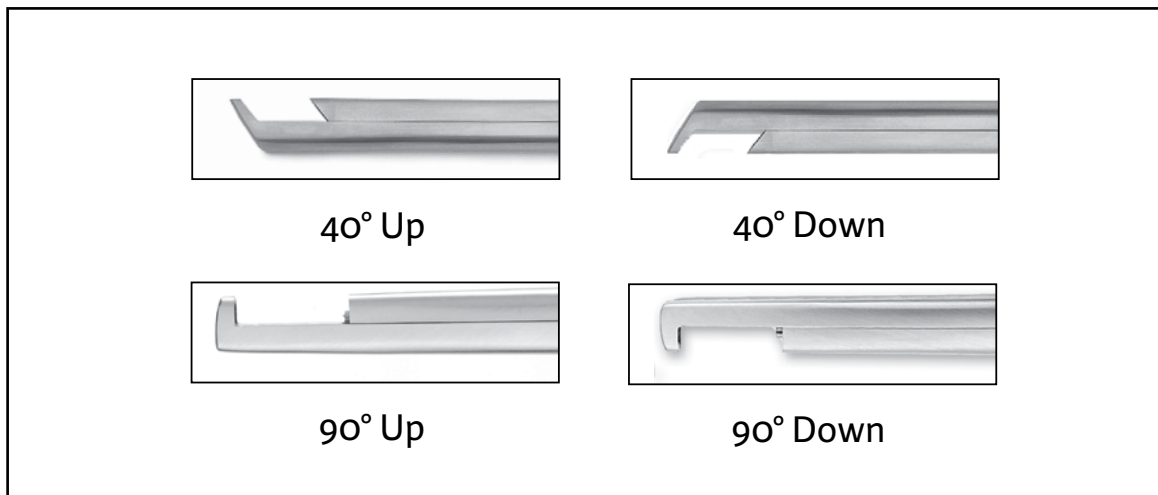

Tolerances in the product specifications, due to hand craftsmanship of the instrument, are subject to minor variations in dimensions and finishes.

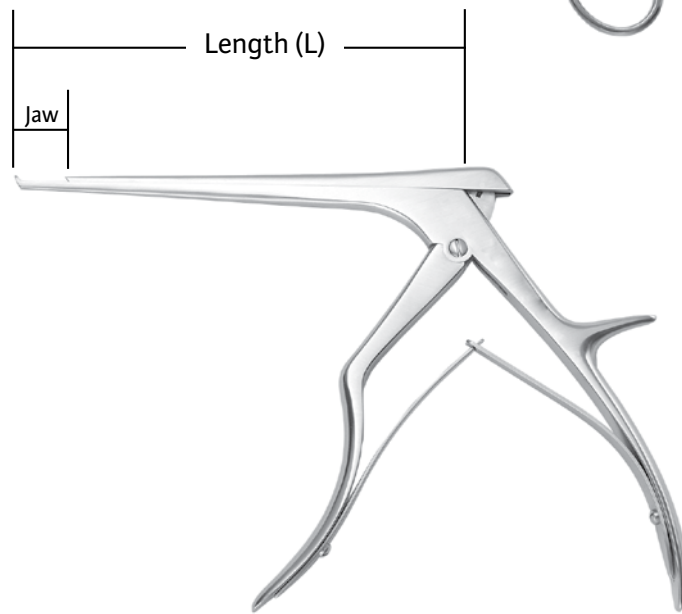
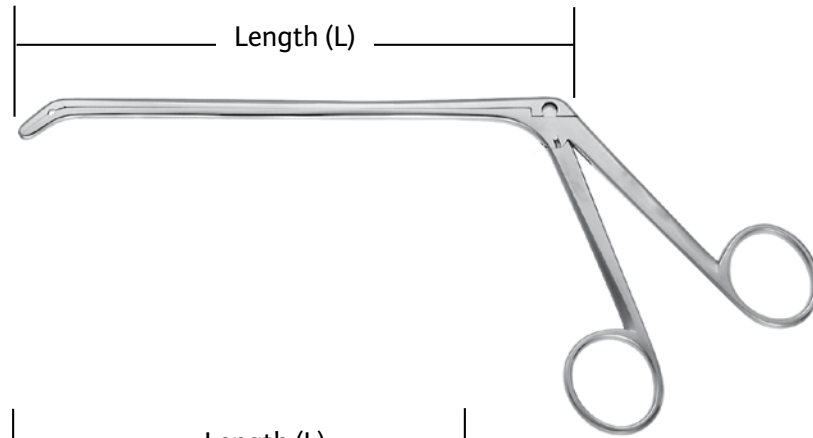
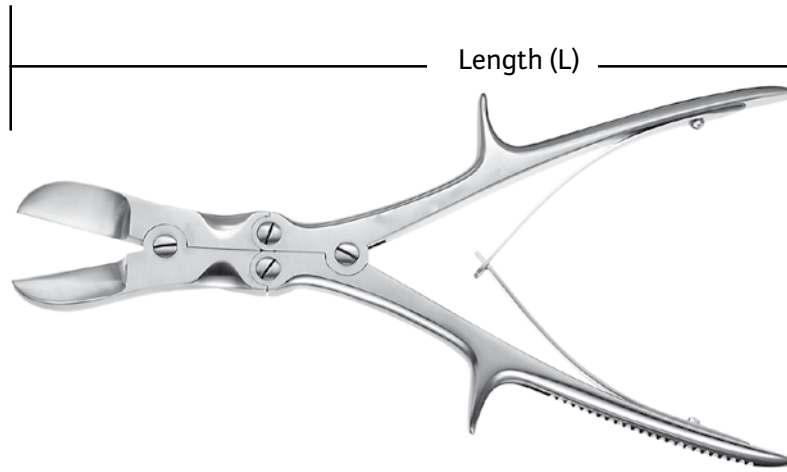

Tolerances in the product specifications, due to hand craftsmanship of the instrument, are subject to minor variations in dimensions and finishes.

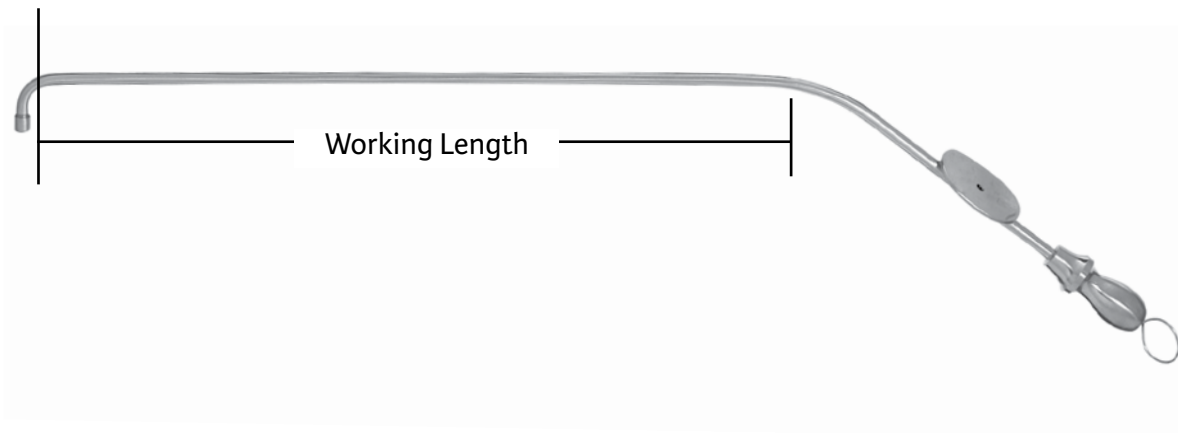
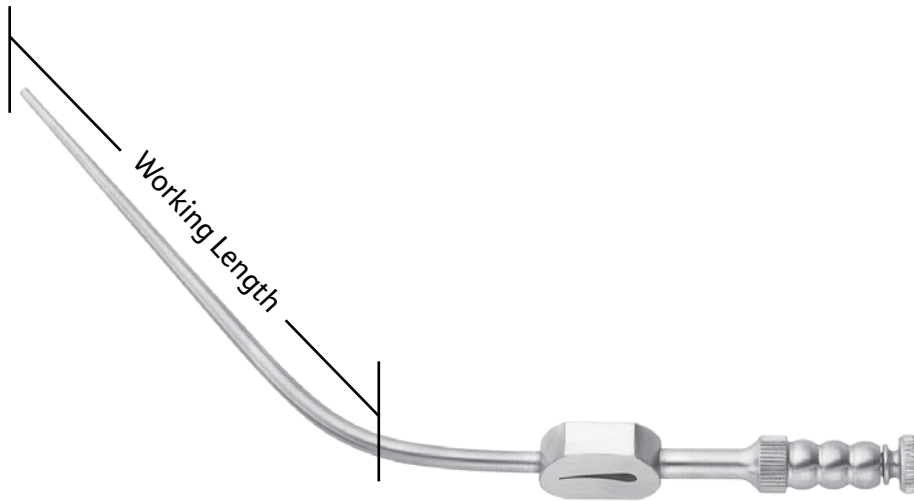
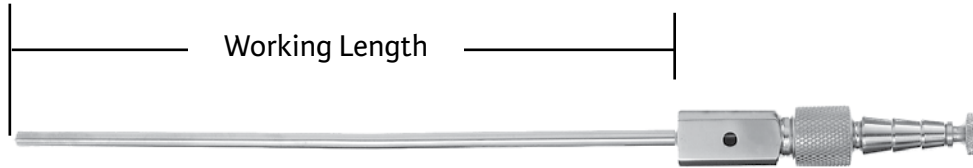

Tolerances in the product specifications, due to hand craftsmanship of the instrument, are subject to minor variations in dimensions and finishes.



**Integra<sup>®</sup>**  
Access  
Instrumentation



**Gigli Saw Handle**

one pair (2)

Catalog #	Description
RNo074	Loop Handle



**Gigli Saw Handle**

one pair (2)

Catalog #	Description
RNo075	Solid "T" Handle



**Strully-Gigli Handle**

blade lock, one pair (2)

The Strully-Gigli saw handles have a quick and easy locking device which prevents disengagement of the saw blade from the handle.

Catalog #	Description
RNo076	Loop Handle



**Strully-Gigli Handle**

blade lock, one pair (2)

The Strully-Gigli saw handles have a quick and easy locking device which prevents disengagement of the saw blade from the handle.

Catalog #	Description
RNo077	Solid "T" Handle



### Gigli Wire Saw Blades

package of 1 (one)

Catalog #	Description
RNo070	9" (230mm)
RNo071	11¾" (300mm)
RNo072	19¾" (500mm)
RNo073	30" (760mm)

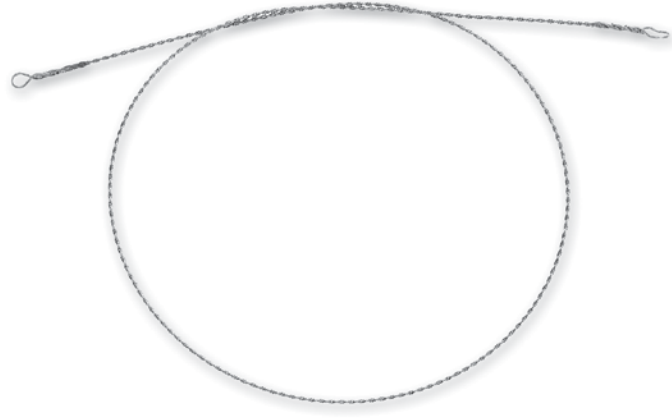

RNo070

### Bailey Gigli Saw Guides

Catalog #	Description	Length
RNo061	Straight	12" (305mm)
RNo062	Curved	12" (305mm)



RNo062

### Raney Saw Guide

Catalog #	Description	Length
RB1063	Curved	9¼" (232mm)



### Early Spinal Fusion Knife

Catalog #	Description	Length	Tip Length
RO515	Angled Tip	9" (229mm)	3.5mm



### Paine's Carpal Tunnel Retinaculotome

Catalog #	Description	Length	Tip Length	Tip Width
RO520	Angled Blade	7 1/4" (185mm)	18mm	7.5mm



### Paganelli Paine Carpal Tunnel Retinaculotome

Catalog #	Description	Length	Tip Length	Tip Width
RO521	Angled Blade	7" (180mm)	14mm	7.5mm



**Adson Dura Hooks**

Catalog #	Description	Length
RNo120	Sharp	7¾" (200mm)
RNo121	Blunt	7¾" (200mm)



RNo120

**Sachs Dura Hook**

Catalog #	Description	Length
Ro200	Sharp Tip	6" (154mm)



**Cushing Dura Hook**

Catalog #	Description	Length
Ro205	Sharp Tip	5½" (140mm)



**Lahey Clinic Dura Hook**

Catalog #	Description	Length
Ro212	Sharp Tip	5¼" (133mm)



**Endonasal Pituitary Hook,  
45° Angle**

Catalog #	Length
RN6021	9¾" (246mm)



### Dandy Nerve Hooks

Catalog #	Description	Length
Ro860	Straight	9" (230mm)
Ro861	Left	8¾" (225mm)
Ro862	Right	8¾" (225mm)



### Hoehn Nerve Hooks

Catalog #	Description	Length
RNo123	Straight	9" (230mm)
RNo124	Left	8¾" (225mm)

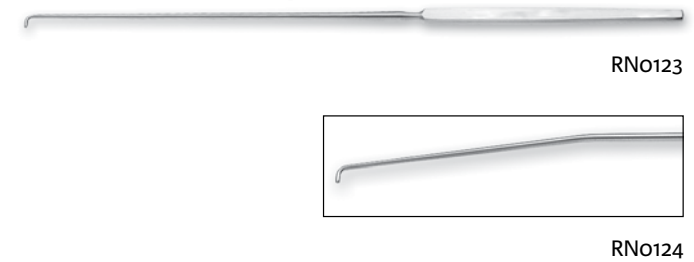

### Murphy Ball Hooks Full Curve

Catalog #	Length	Diameter
Ro848	8" (203mm)	2.5mm
RNo128	9" (229mm)	2.5mm



### Cushing Gasserian Ganglion Hook

Catalog #	Description	Length
RB1109	Blunt	9" (230mm)



### Smithwick Button Hook

Catalog #	Description	Length
RB1110	Blunt	8¼" (210mm)

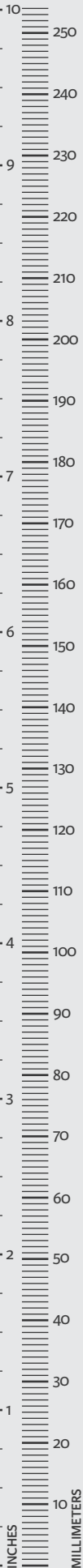

### Dorsey Dura Separator

Catalog #	Description	Length	Blade Size
RO231	Angled Blade	6" (155mm)	4.75 x 18mm



### Double Ended Dura Separator

Catalog #	Description	Length	Blade Size
RO233	Double Ended	5¾" (145mm)	3.6 x 14 x 18mm



### Frazier Dura Separator

Catalog #	Description	Length	Blade Size
RNO211	Angled Tapered Blade	6½" (165mm)	3.2 x 10.5mm





**Olivecrona Double Ended Dissectors**

Catalog #	Description	Length	Tip Width	Tip Width
RO175	Heavy	7¾" (196mm)	5.1mm	4.1mm
RO176	Light	7¼" (185mm)	3mm	2.4mm
RO177	Heavy	9½" (240mm)	5.1mm	4.5mm
RO178	Light	9½" (240mm)	3mm	2.4mm



RO177

**Davis Nerve Separator and Spatula**

Catalog #	Description	Length	Tip Width
RO240	Semi-Sharp	7¾" (196mm)	3.2mm



**Freer Elevator**

Catalog #	Description	Length	Tip Width	Tip Width
RO243	Sharp/Blunt Full Curve	8¼" (210mm)	6mm	6.3mm



**Freer Double Ended Dissector**

Catalog #	Description	Length	Tip Width	Tip Width
RO244	Double Ended	7¾" (195mm)	5mm	5mm



**Penfield Dura Dissectors**

Catalog #	Style	Length
RNo401	#1	7" (180mm)
RNo402	#2	7¼" (185mm)
RNo403	#3	7¼" (185mm)
RNo404	#4	8" (203mm)
RNo405	#5	11¼" (288mm)



RNo401



RNo402



RNo403



RNo404



RNo405

**Ballenger Septum Elevator**

Catalog #	Length	Tip Width
RNo335	8¾" (222mm)	3mm



### Woodson Elevator and Spatula

Catalog #	Description	Length	Blade Sizes	Tip Width
RNo222	Double Ended	10" (256mm)	2.75mm	3.4mm



### Woodson Elevator

Catalog #	Description	Length	Tip	Tip
Ro265	Double Ended	7 1/4" (184mm)	11.5 x 3.3mm	11 x 2.6mm



### Woodson Dura Separator and Packer

Catalog #	Description	Length	Tip Width Packer	Tip Width Separator
RNo413	Double Ended	7" (178mm)	3.2mm	3mm



### Woodson Packer

Catalog #	Description	Length	Tip Width	Tip Width
Ro267	Double Ended	6 3/4" (171mm)	4mm	4.5mm



### Oldberg Dissector

Catalog #	Length	Tip Width
Ro268	7" (178mm)	5.6mm



### Adson Periosteal Elevators

6<sup>3</sup>/<sub>4</sub>" (170mm)

Catalog #	Description	Tip Width
Ro260	Straight, Chisel Edge	9.2mm
Ro261	Curved, Semi-Sharp	6.5mm
Ro262	Curved, Blunt	8mm
Ro263	Straight, Semi-Sharp	6.8mm



Ro260



Ro261



Ro262



Ro263

### Love-Adson Periosteal Elevator

Catalog #	Description	Length	Tip Width
Ro295	Curved Blade, Semi-Sharp	6 <sup>1</sup> / <sub>2</sub> " (165mm)	5mm



### Joseph Periosteal Elevator

Catalog #	Description	Length	Tip Width
Ro269	Curved Blade	6 <sup>1</sup> / <sub>2</sub> " (165mm)	6mm



**Cushing Periosteal Elevators**

Catalog #	Description	Length	Tip Width
<b>Ro289</b>	Rounded Edge, Serrated	7¼" (186mm)	16mm
<b>Ro290</b>	Rounded Edge, Sharp	7¼" (186mm)	16mm
<b>Ro291</b>	Square Edge, Sharp	7¼" (186mm)	16mm



Ro289



Ro290



Ro291

**Cushing Periosteal Elevators**

Catalog #	Description	Length	Tip Width
<b>Ro285</b>	Left	7¾" (200mm)	5mm
<b>Ro286</b>	Right	7¾" (200mm)	5mm



Ro285

### Cottle Septum Elevator

Catalog #	Description	Length	Tip Width
RN0326	Double Ended, Graduated	9" (226mm)	4.9mm



### John Day Periosteal Elevators

Catalog #	Description	Length	Tip Width
R8906	Straight	8" (203mm)	6mm
R8907	30° Angle w/Cup	8" (203mm)	6mm
R8908	20° Angle 10mm from Cup	8" (203mm)	6mm
R8909	Straight	8¼" (208mm)	12mm



R8906



R8909

**T. Fukushima Dural Elevator and Spatulas**  
double ended

Catalog #	Description	Length	Blade Width	Blade Width
R8911	Double Ended	8¼" (210mm)	5mm	5mm
R8912	Double Ended, Reduced	8¼" (210mm)	3mm	3mm



R8911



R8912



### Cobb Type Spinal Elevators

solid hexagonal handle

Catalog #	Length	Blade Width
RB1543	9½" (240mm)	⅜" (9.5mm)
RB1544	9½" (240mm)	½" (12.7mm)
RB1545	9½" (240mm)	¾" (19.1mm)
RB1546	9½" (240mm)	1" (25.4mm)
RB1547	9½" (240mm)	1¼" (32mm)



RB1546

### Cobb Type Spinal Elevators

round knurled handle

Catalog #	Length	Blade Width
Ro294	11" (280mm)	⅜" (9.5mm)
Ro296	11" (280mm)	½" (12.7mm)
Ro297	11" (280mm)	¾" (19.1mm)
Ro298	11" (280mm)	1" (25.4mm)
Ro299	11" (280mm)	1¼" (32mm)



Side view, close-up of Ro294

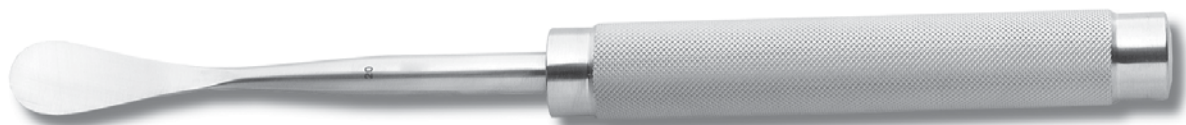

Ro297



**Lambotte Osteotomes**

7 1/4" (184mm), straight

Catalog #	Width
RB1453	4mm
RB1454	5mm
RB1455	6mm
RB1456	8mm
RB1457	10mm
RB1458	12mm
RB1459	16mm
RB1460	19mm
RB1461	22mm
RB1462	25mm

**Lambotte Osteotomes**

9" (229mm), straight

Catalog #	Width
R2200	1/4" (6mm)
R2201	1/2" (12mm)
R2202	3/4" (19mm)
R2203	1" (25mm)
R2204	1 1/4" (32mm)
R2205	1 1/2" (38mm)



Straight



R2202

**Lambotte Osteotomes**

7 1/4" (184mm), curved

Catalog #	Width
RB1463	4mm
RB1464	5mm
RB1465	6mm
RB1466	8mm
RB1467	10mm
RB1468	12mm
RB1469	16mm
RB1470	19mm
RB1471	22mm
RB1472	25mm

**Lambotte Osteotomes**

9" (229mm), curved

Catalog #	Width
R2210	1/4" (6mm)
R2211	1/2" (12mm)
R2212	3/4" (19mm)
R2213	1" (25mm)
R2214	1 1/4" (32mm)
R2215	1 1/2" (38mm)



Curved



### Gerzog Bone Mallet

Catalog #	Description	Length	Head
RB1695	Lead Filled	7½" (190mm)	1" (25mm)

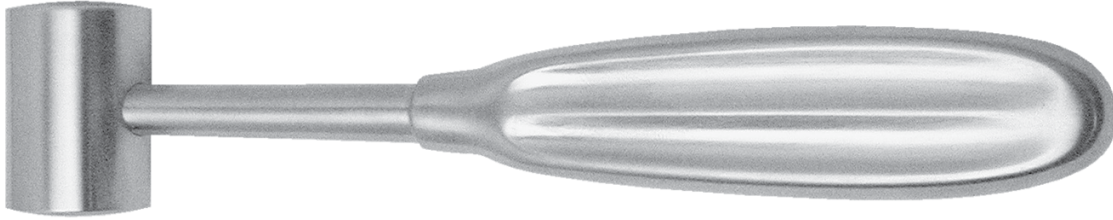

**Lumbar and Cervical Impactors**

Catalog #	Description	Length	Tip Size
R6540	Standard Guarded	8½" (216mm)	7 x 12.5mm
R6541	Standard	8½" (216mm)	7 x 12.5mm
R6542	Wide Guarded	8½" (216mm)	10 x 13mm
R6543	Wide	8½" (216mm)	10 x 13mm
R6544	Offset	8½" (216mm)	6.5 x 11.5mm
R6545	Angled	8½" (216mm)	6.5 x 16mm
R6546	Narrow	8½" (216mm)	6 x 12.5mm
R6547	Micro, Offset	7" (178mm)	4.3 x 10mm
R6548	Micro, Lateral	7" (178mm)	4.3 x 10mm



R6540



R6543



R6544



R6545



R6546



R6547



R6548



**Integra**<sup>®</sup>  
Retractors

## Ruggles®-Redmond™ Anterior Cervical Fusion Distraction System, Complete

Catalog #	Description
R6000	ACF Complete System with Sterilization Tray

Includes (1) each of following: R6298, R6310, R6312, R6313, R6314, R6315, R6316, R6317, R6318, R6319, R6320, R6321, R6337, R6370, R6371, R6372, R6373, R6374, R6375, R6376, R6377, R6378, R6379, R6381, R6382, R6383, R6384, R6385, R6387, R6388, R6389, R6390, R6391, R6392, R6393, R6394, R6396, R6399, RN2877, RN2878, RN2879 and (2) each of R9395

### ACF Distractor Drill Guides

Catalog #	Description	Tube Guide Length
R6388	Left	3 1/8" (80mm)
R6393	Right	3 1/8" (80mm)

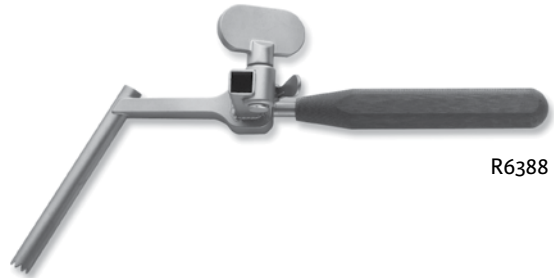

R6388

### ACF Distractors

Catalog #	Description	Ratchet Bar Length
R6387	Single Level, Left	3 7/8" (100mm)
R6389	Multiple Level, Left	4 5/8" (117mm)
R6392	Single Level, Right	3 7/8" (100mm)
R6394	Multiple Level, Right	4 5/8" (117mm)



R6387

### ACF Screwdriver

Catalog #	Description	Length
R9396	Straight	7 3/4" (200mm)



### ACF Twist Drill

Catalog #	Length	Bit Length
R9395	5 1/4" (133mm)	8mm



### ACF Distraction Screws

Catalog #	Description	Tip Length
RN2877	Non-Sterile	12mm
RN2878	Non-Sterile	14mm
RN2879	Non-Sterile	16mm
R6367A	Sterile	12mm
R6398A	Sterile	14mm
R6397A	Sterile	16mm



R6397A

### ACF Transverse Body Retractor

Catalog #	Description	Length	Spread
R6312	Ball Snaps	5 $\frac{1}{8}$ " (129mm)	2 $\frac{7}{8}$ " (73mm)



Blades sold separately

### ACF Longitudinal Body Retractor

Catalog #	Description	Length	Spread
R6313	Ball Snaps	6 $\frac{1}{2}$ " (168mm)	2" (52mm)



Blades sold separately

### ACF Medial Retractor Blades, Ball Snap long teeth

Catalog #	Description	Size
R6555	Short Length	25 x 23mm
R6556	Short Length	30 x 23mm
R6557	Short Length	35 x 23mm
R6370	Medium Length	40 x 23mm
R6371	Medium Length	45 x 23mm
R6372	Medium Length	50 x 23mm
R6373	Medium Length	55 x 23mm
R6374	Medium Length	60 x 23mm
R6558	Long Length	65 x 23mm
R6559	Long Length	70 x 23mm



R6559

### ACF Longitudinal Retractor Blades, Ball Snap blunt

Catalog #	Description	Size
R6550	Short Length	30 x 23mm
R6551	Short Length	35 x 23mm
R6552	Short Length	40 x 23mm
R6381	Medium Length	45 x 23mm
R6382	Medium Length	50 x 23mm
R6383	Medium Length	55 x 23mm
R6384	Medium Length	60 x 23mm
R6385	Medium Length	65 x 23mm
R6553	Long Length	70 x 23mm
R6554	Long Length	75 x 23mm



R6554

**ACF Lateral Retractor Blades, Ball Snap**  
short teeth

Catalog #	Description	Size
R6560	Short Length	25 x 23mm
R6561	Short Length	30 x 23mm
R6562	Short Length	35 x 23mm
R6375	Medium Length	40 x 23mm
R6376	Medium Length	45 x 23mm
R6377	Medium Length	50 x 23mm
R6378	Medium Length	55 x 23mm
R6379	Medium Length	60 x 23mm
R6563	Long Length	65 x 23mm
R6564	Long Length	70 x 23mm



R6564

**ACF Fenestrated Iliac Blades, Ball Snap**

Catalog #	Size
R6320	50 x 23mm
R6321	60 x 23mm



R6321

**ACF Blade Ejector**

Catalog #	Length
R6310	4 1/2" (115mm)



**Cloward Style Depth Gauge**

Catalog #	Length
RB2375	7" (178mm)



**Caspar Style Caliper**

Catalog #	Length
R6317	8" (203mm)

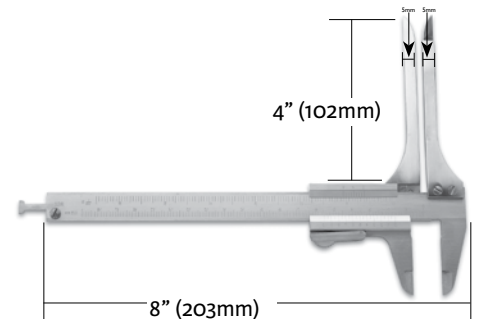

### Caspar Style Bone Graft Harvesting Forceps

Catalog #	Length	Width
R6318	8 <sup>3</sup> / <sub>4</sub> " (222mm)	9mm
R6319	8 <sup>3</sup> / <sub>4</sub> " (222mm)	7mm

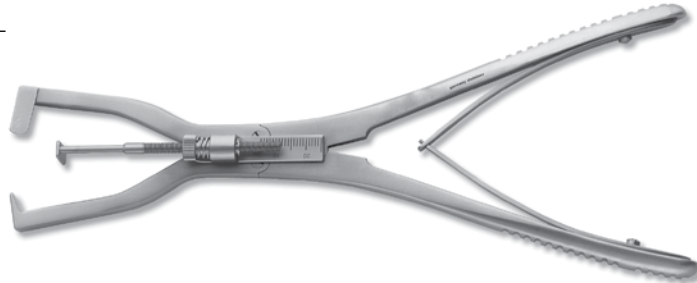

R6318

### Caspar Style Bone Graft Impactors

Catalog #	Length	Diameter
R6314	7 <sup>3</sup> / <sub>4</sub> " (200mm)	3mm
R6315	7 <sup>3</sup> / <sub>4</sub> " (200mm)	5mm
R6316	7 <sup>3</sup> / <sub>4</sub> " (200mm)	8mm



R6315

### Caspar Style Bone Graft Holder

Catalog #	Length
R6399	8 <sup>1</sup> / <sub>2</sub> " (217mm)



### Caspar Style Vertebral Body Dissectors

Catalog #	Description	Length
R6390	Small, 3.2mm 130°	8 <sup>3</sup> / <sub>4</sub> " (220mm)
R6391	Large, 3.2mm 120°	8 <sup>3</sup> / <sub>4</sub> " (220mm)



R6391

### Vertebral Body Dissector

Catalog #	Description	Length
R6337	Micro	8 <sup>1</sup> / <sub>4</sub> " (210mm)





**Anterior Cervical Fusion Tray**

**Catalog #**  
**R6298**

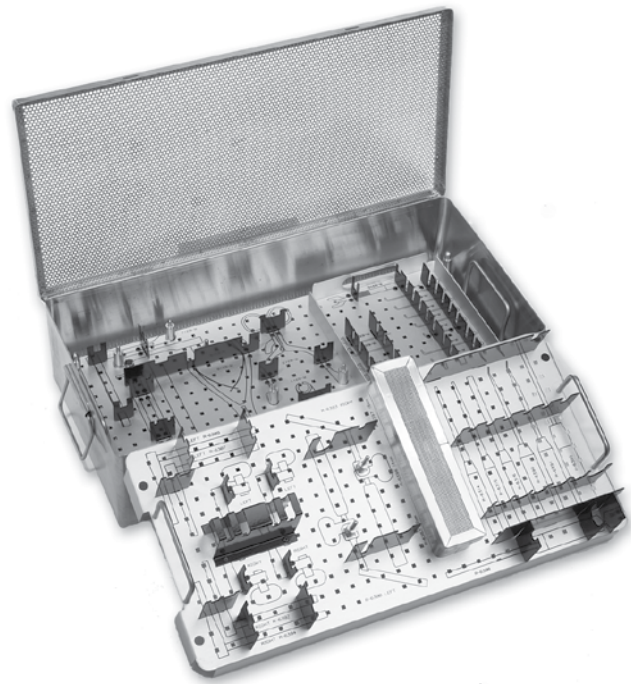

**Carbon Fiber Retractor Blades, Radiolucent**

Catalog #	Body	Teeth
RB2471	40 x 23mm	Long
RB2472	45 x 23mm	Long
RB2473	50 x 23mm	Long
RB2474	55 x 23mm	Long
RB2475	60 x 23mm	Long
RB2481	40 x 23mm	Short
RB2482	45 x 23mm	Short
RB2483	50 x 23mm	Short
RB2484	55 x 23mm	Short
RB2485	60 x 23mm	Short
RB2491	40 x 23mm	Blunt
RB2492	45 x 23mm	Blunt
RB2493	50 x 23mm	Blunt
RB2494	55 x 23mm	Blunt
RB2495	60 x 23mm	Blunt



RB2473



### MLD Retractor

Catalog #	Description	Spread
R6405	MLD Retractor Body	4½" (113mm)



### MLD Center Retractor Blades, Ball Snap

Catalog #	Length
R6407	35 x 14mm
R6408	40 x 14mm
R6409	45 x 14mm
R6410	50 x 14mm
R6411	55 x 14mm
R6412	60 x 14mm



R6412

### Blade Ejector, Ball Snap Closure

Catalog #	Length
R6310	4½" (115mm)



### MLD Speculum Retractors

black coated

Catalog #	Length
R6413	40mm
R6414	45mm
R6415	50mm
R6416	55mm
R6417	60mm
R6418	65mm



R6418

**UMLD Scoville Retractor**  
double hinged

Catalog #	Description	Spread
R6579	Scoville Retractor Body	5¾" (145mm)



**UMLD Retractor Blades, Ball Snap**

Catalog #	Size
R6630	50 x 10mm
R6631	60 x 10mm
R6632	50 x 20mm
R6633	60 x 20mm



R6630

**UMLD Retractor Blades, Ball Snap**  
black coated

Catalog #	Size
R6601	65 x 15mm
R6602	70 x 15mm
R6603	75 x 15mm
R6604	85 x 15mm



R6604

**Blade Ejector, Ball Snap Closure**

Catalog #	Length
R6310	4½" (115mm)



### UMLD Scoville Blades, Ball Snap

Catalog #	Size
R6641	40 x 38mm
R6644	67 x 32mm



R6641

### UMLD Taylor Blades, Ball Snap

Catalog #	Size
R6643	40 x 51mm
R6640	44 x 38mm
R6642	63 x 57mm



R6640

### UMLD Hooks, Ball Snap

Catalog #	Size
R6621	50mm
R6622	60mm



R6621

### UMLD T-Bars, Ball Snap

Catalog #	Size
R6623	50mm
R6624	60mm

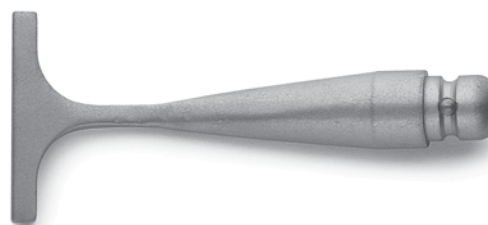

R6623

With multiple blade and retractor options, the Flexi-Spine Retractor System is used for single-level and multi-level procedures in cervical fusion and microlumbar discectomy cases. The system remains secure during surgical procedures and is designed for easy identification, insertion, and retraction.

### Ruggles®-Redmond™ Flexi-Spine™ Retraction System

Catalog #	Description
<b>RU2400</b>	Complete Set Consists of: two (2) each Retractor Handles (RU2403) one (1) each Transverse Retractor Body (RU2408) one (1) each Longitudinal Retractor Body (RU2409) one (1) each Instrument Tray (RS2400) one (1) each Depth Gauge (RU2422) one (1) set (12) pair (RU2404, RU2405, RU2406) one (1) set (6) each (RU2407)

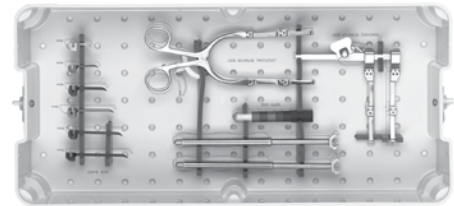
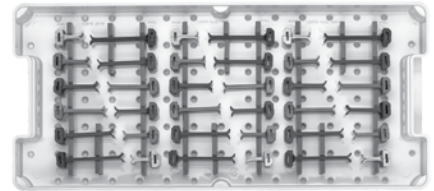

### Flexi-Spine Instrument Tray

Catalog #
<b>RS2400</b>

### Flexi-Spine Transverse Body Retractor

Catalog #
<b>RU2408</b>

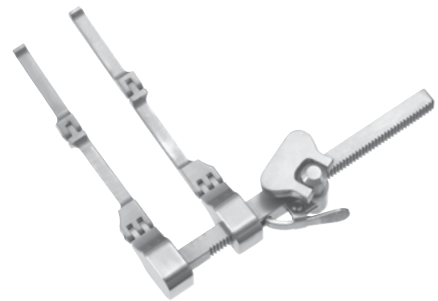

### Flexi-Spine Longitudinal Retractor Body

Catalog #
<b>RU2409</b>



### Flexi-Spine Depth Gauge

Catalog #	Description
<b>RU2422</b>	color coded

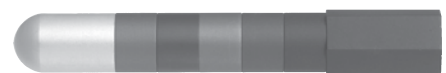

### Flexi-Spine Retractor Blade Handle

Catalog #	Description
RU2403	7½" (188mm)



### RU2404 Short Teeth Flexi-Spine Blade Set (12 pair)

Catalog #	Color	Size	Catalog #	Color	Size
RU2410	Silver	15 x 25mm	RU2416	Silver	20 x 25mm
RU2411	Blue	15 x 35mm	RU2417	Blue	20 x 35mm
RU2412	Red	15 x 45mm	RU2418	Red	20 x 45mm
RU2413	Green	15 x 55mm	RU2419	Green	20 x 55mm
RU2414	Purple	15 x 65mm	RU2420	Purple	20 x 65mm
RU2415	Black	15 x 75mm	RU2421	Black	20 x 75mm



### RU2405 Blunt Flexi-Spine Blade Set (12 pair)

Catalog #	Color	Size	Catalog #	Color	Size
RU2446	Silver	15 x 25mm	RU2452	Silver	20 x 25mm
RU2447	Blue	15 x 35mm	RU2453	Blue	20 x 35mm
RU2448	Red	15 x 45mm	RU2454	Red	20 x 45mm
RU2449	Green	15 x 55mm	RU2455	Green	20 x 55mm
RU2450	Purple	15 x 65mm	RU2456	Purple	20 x 65mm
RU2451	Black	15 x 75mm	RU2457	Black	20 x 75mm



### RU2406 Long Teeth Flexi-Spine Blade Set (12 pair)

Catalog #	Color	Size	Catalog #	Color	Size
RU2428	Silver	15 x 25mm	RU2434	Silver	20 x 25mm
RU2429	Blue	15 x 35mm	RU2435	Blue	20 x 35mm
RU2430	Red	15 x 45mm	RU2436	Red	20 x 45mm
RU2431	Green	15 x 55mm	RU2437	Green	20 x 55mm
RU2432	Purple	15 x 65mm	RU2438	Purple	20 x 65mm
RU2433	Black	15 x 75mm	RU2439	Black	20 x 75mm

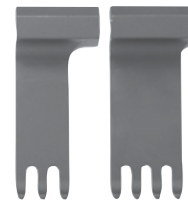

### RU2407 Flexi-Spine Hook Set (6 hooks)

Catalog #	Color	Size	Catalog #	Color	Size
RU2464	Silver	18mm	RU2467	Green	48mm
RU2465	Blue	28mm	RU2468	Purple	58mm
RU2466	Red	38mm	RU2469	Black	68mm



**Ruggles®-Redmond™ Spinal Retraction System**

Catalog #	Description
RN2800	Complete Set Consists of: two (2) each Retractor Handles (RN2803) one (1) each Transverse Retractor Body (RN2801) one (1) each Longitudinal Retractor Body (RN2802) one (1) each Instrument Tray (RS2800) one (1) set (12) pair (RN28110-RN28121) one (1) set (12) pair (RN28210-RN28221) one (1) set (12) pair (RN28310-RN28321) one (1) set (6) pair (RN28410-RN28415)



**Spinal Retractor System Tray**

Catalog #
RN2800

**Spinal Transverse Retractor Body**

Catalog #	Length
RN2801	5 1/4" (133mm)



Blades sold separately

**Spinal Longitudinal Retractor Body**

Catalog #	Length
RN2802	8 1/2" (213mm)



Blades sold separately

**Spinal Retractor Blade Handle**

Catalog #	Length
RN2803	7 1/4" (184mm)





**Spinal Short Teeth Blades (pair)**

black coated

Catalog #	Size	Catalog #	Size	Catalog #	Size
RN28110	15 x 25mm	RN28116	20 x 25mm	RN28122	30 x 25mm
RN28111	15 x 35mm	RN28117	20 x 35mm	RN28123	30 x 35mm
RN28112	15 x 45mm	RN28118	20 x 45mm	RN28124	30 x 45mm
RN28113	15 x 55mm	RN28119	20 x 55mm	RN28125	30 x 55mm
RN28114	15 x 65mm	RN28120	20 x 65mm	RN28126	30 x 65mm
RN28115	15 x 75mm	RN28121	20 x 75mm	RN28127	30 x 75mm

**Spinal Long Teeth Blades (pair)**

black coated

Catalog #	Size	Catalog #	Size	Catalog #	Size
RN28210	15 x 25mm	RN28216	20 x 25mm	RN28222	30 x 25mm
RN28211	15 x 35mm	RN28217	20 x 35mm	RN28223	30 x 35mm
RN28212	15 x 45mm	RN28218	20 x 45mm	RN28224	30 x 45mm
RN28213	15 x 55mm	RN28219	20 x 55mm	RN28225	30 x 55mm
RN28214	15 x 65mm	RN28220	20 x 65mm	RN28226	30 x 65mm
RN28215	15 x 75mm	RN28221	20 x 75mm	RN28227	30 x 75mm

**Spinal Blunt Blades (pair)**

black coated

Catalog #	Size	Catalog #	Size	Catalog #	Size
RN28310	15 x 25mm	RN28316	20 x 25mm	RN28322	30 x 25mm
RN28311	15 x 35mm	RN28317	20 x 35mm	RN28323	30 x 35mm
RN28312	15 x 45mm	RN28318	20 x 45mm	RN28324	30 x 45mm
RN28313	15 x 55mm	RN28319	20 x 55mm	RN28325	30 x 55mm
RN28314	15 x 65mm	RN28320	20 x 65mm	RN28326	30 x 65mm
RN28315	15 x 75mm	RN28321	20 x 75mm	RN28327	30 x 75mm

**Spinal Hooks (each)**

black coated

Catalog #	Size
RN28410	18mm
RN28411	28mm
RN28412	38mm
RN28413	48mm
RN28414	58mm
RN28415	68mm



Note: Unannodized versions available for Europe and Canada with "EU" at end of catalog number.



The LumbarTrak Retraction System is flexible enough to be used for many lumbar and thoracic spinal procedures from microdiscectomies to multilevel fusions. The retractor blades are made of titanium which is lighter and more radiolucent than stainless steel.

**Ruggles®-Redmond™ LumbarTrak™ Retraction System**

Catalog #	Description
<b>RB2600</b>	Lumbar Retractor System Includes: One (1) each of: RB2601B, RB2602, RB2606, RBT2600 Two (2) each of: RB2605, RB2620–RB2633, RB2640–RB2648 Four (4) each of: RB2603–RB2604, RB2610–RB2617

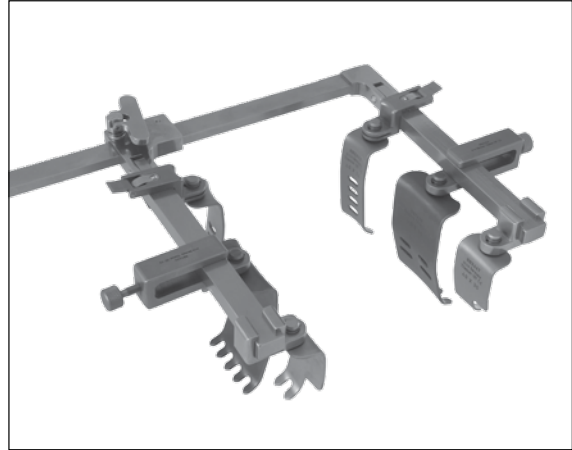

**LumbarTrak Square Retractor (not pictured)**  
stainless steel

Catalog #
<b>RB2601B</b>

**Scoville Retractor**  
titanium

Catalog #
<b>RB2602</b>

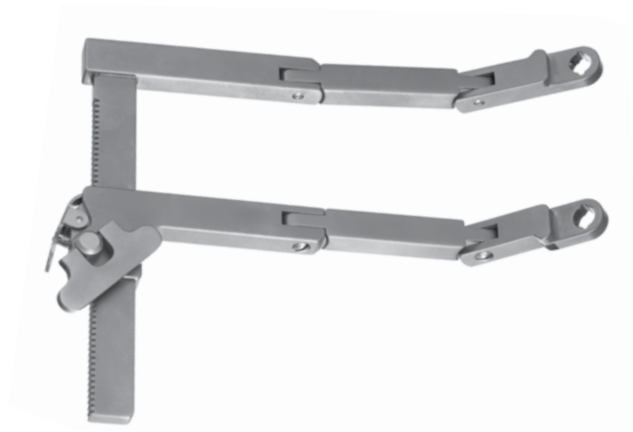

**LumbarTrak Quick Connector (set of 4)**

titanium

Catalog # \_\_\_\_\_  
RB2603



**LumbarTrak Long Connector (set of 4)**

titanium

Catalog # \_\_\_\_\_  
RB2604

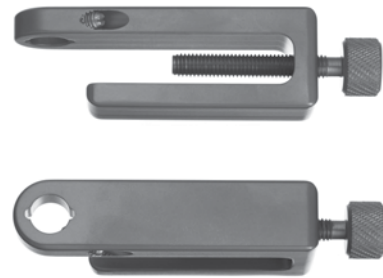

**Spare Screw for RB2604 (not pictured)**

Catalog # \_\_\_\_\_  
RB2604S

**LumbarTrak Blade Handle**

Catalog # \_\_\_\_\_  
RB2605

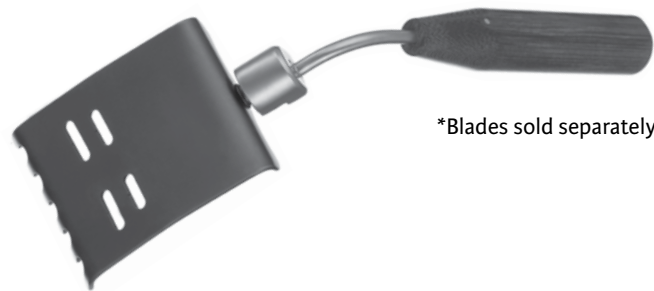

\*Blades sold separately

**LumbarTrak Titanium Depth Gauge**

Catalog #	Description
RB2606	Color Coded



**LumbarTrak Ball Snap Blade Ejector**

Catalog # \_\_\_\_\_  
RB2609



**LumbarTrak Thin Blades**

titanium

Catalog #	Color	Blade
RB2610	Purple	24 x 30mm
RN28311	Light Blue	24 x 40mm
RN28312	Green	24 x 50mm
RN28313	Pink	24 x 60mm
RN28314	Dark Blue	24 x 70mm
RN28315	Gold	24 x 90mm
RB2616	Purple	24 x 110mm
RB2617	Light Blue	24 x 130mm
RB2618	Silver	24 x 80mm

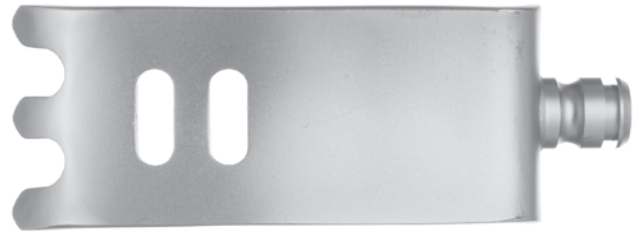

**LumbarTrak Medium Blades**

titanium

Catalog #	Color	Blade
RB2621	Green	45 x 60mm
RB2623	Pink	45 x 60mm
RB2625	Dark Blue	45 x 70mm
RB2627	Gray	45 x 80mm
RB2629	Gold	45 x 90mm
RB2631	Purple	45 x 110mm
RB2633	Light Blue	45 x 130mm

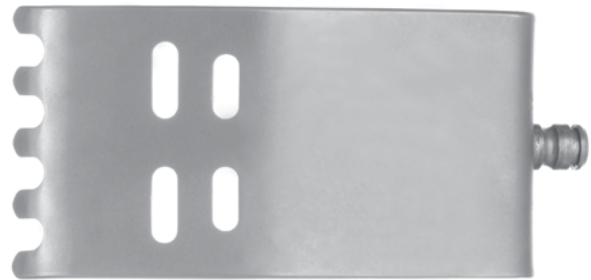

**LumbarTrak Wide Blades**

titanium

Catalog #	Color	Blade
RB2620	Green	60 x 50mm
RB2622	Pink	60 x 60mm
RB2624	Dark Blue	60 x 70mm
RB2626	Gray	60 x 80mm
RB2628	Gold	60 x 90mm
RB2630	Purple	60 x 110mm
RB2632	Light Blue	60 x 130mm

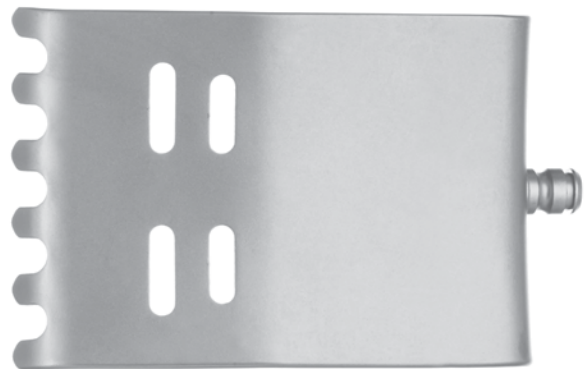

## LumbarTrak Hooks

titanium

Catalog #	Description	Blade Width
RB2640	Light Blue	42mm
RB2641	Green	52mm
RB2642	Pink	62mm
RB2643	Dark Blue	72mm
RB2644	Gold	92mm



## LumbarTrak Sacral Blades

titanium

Catalog #	Body	Color	Blade
RB2645	30 x 40mm	Light Blue	Left
RB2646	60 x 45mm	Green	Left
RB2647	30 x 40mm	Light Blue	Right
RB2648	60 x 45mm	Green	Right



## LumbarTrak Tray

Catalog #

RBT2600

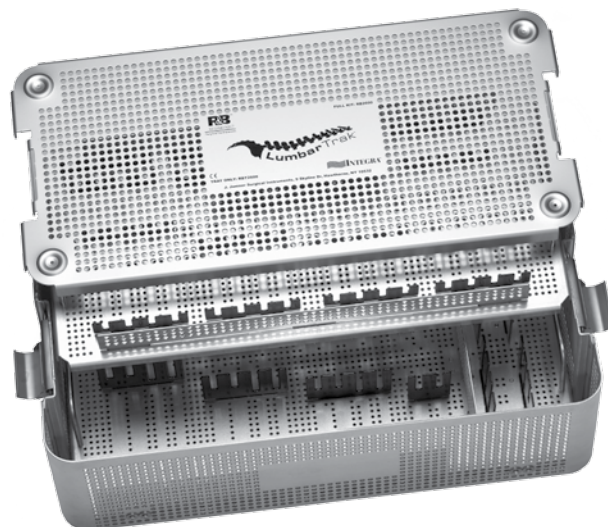

## Spetzler Sonntag Trans-Oral Retractor System

- Improved design for better exposure
- Totally self-retaining
- Complete retraction by secure mounting to mouth gag
- Assembles to table rail for ease of use and stability
- Positions easily in the optimum orientation
- Full line of retractor styles and sizes
- 3 sizes of slotted and non-slotted tongue depressors
- 3 sizes of palate retractors
- 2 sizes of lateral retractors

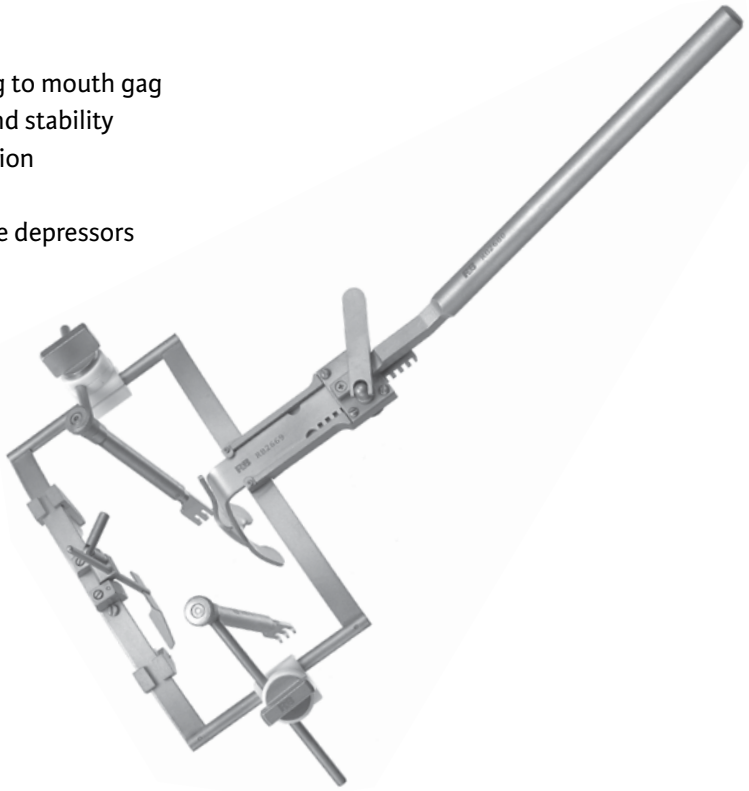

## Spetzler Sonntag Trans-Oral Retractor System

Catalog #	Description
<b>RB2660</b>	Spetzler Sonntag Trans-Oral Retractor System Includes: Two each of RB2661-RB2680 Two each of RB2664 Two each of RB2671 Two each of RBT2660

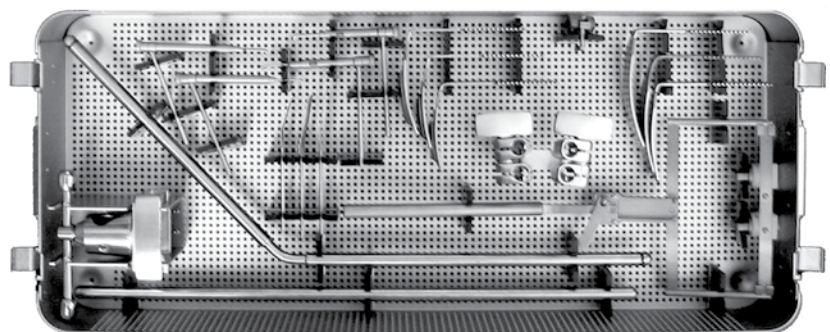

### Trans-Oral Table Clamp

Catalog # \_\_\_\_\_  
RB2661

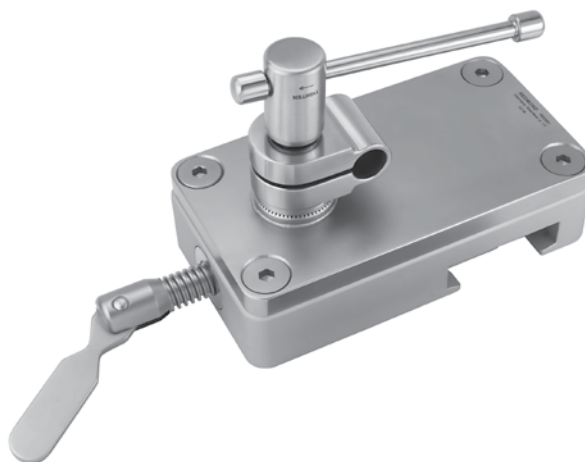

### Mounting Arm, Straight

Catalog #	Description
RB2662	Straight



### Mounting Arm, Angled

Catalog #	Description
RB2663	Angled



### Trans-Oral Mounting Rod Clamp

Catalog # \_\_\_\_\_  
RB2664



**Trans-Oral Tongue Depressors**

Catalog #	Description	Blade Size
RB2665	Short	32 x 84mm
RB2666	Short	35 x 100mm
RB2667	Medium	36 x 106mm



RB2665

**Trans-Oral Slotted Tongue Depressors**

Catalog #	Width	Blade Size
RB2668	28mm	30 x 80mm
RB2669	35mm	35 x 85mm
RB2670	37mm	37 x 95mm



RB2668

**Trans-Oral Table Lateral Retractors**

Catalog #	Description	Angle
RB2672	Short	Left
RB2673	Short	Right
RB2674	Long	Left
RB2675	Long	Right



RB2675

**Trans-Oral Palate Retractors**

Catalog #	Blade Width
RB2676	14mm
RB2677	21mm
RB2678	28mm

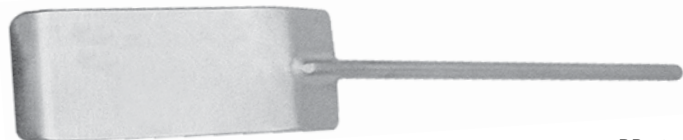

RB2677



### Trans-Oral Mouth Gag

Catalog # \_\_\_\_\_

RB2680



Lateral retractor clamps sold separately

---

### Trans-Oral Lateral Retractor Clamp

Catalog # \_\_\_\_\_

RB2671



---

### Trans-Oral Palate Retractor Clamp

Catalog # \_\_\_\_\_

RB2679



---

### Trans-Oral Retractor Tray

Catalog # \_\_\_\_\_

RBT2660

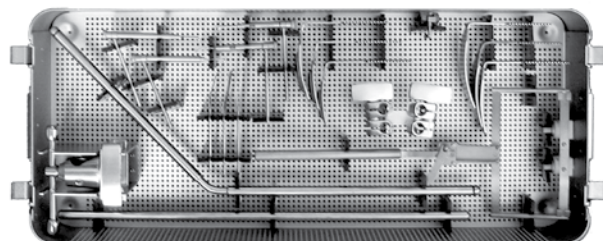



## Spetzler Sonntag Trans-Oral Instruments Set

Catalog #	Description
<b>RB2690</b>	Spetzler Sonntag Trans-Oral Instrument Set Includes: One each of:
<b>RB2656</b>	Disc Dissector, 90°
<b>RB2657</b>	Disc Dissector, 45°
<b>RB2658</b>	Disc Dissector, 0°
<b>RN5743H</b>	Love-Gruenwald IVD, 7" (178mm)
<b>RN5743HX</b>	IVD with Teeth, 3mm, 7" (178mm)
<b>R2800</b>	Flatback Fusion Curette, 00000, Straight, 9" (229mm)
<b>R2801</b>	Flatback Fusion Curette, 0000, Straight, 9" (229mm)
<b>R2820</b>	Flatback Fusion Curette, 00000, 40°, 9" (229mm)
<b>R2821</b>	Flatback Fusion Curette, 0000, 40°, 9" (229mm)
<b>R2840</b>	Flatback Fusion Curette, 00000, 90°, 9" (229mm)
<b>R2841</b>	Flatback Fusion Curette, 0000, 90°, 9" (229mm)
<b>RBT2690</b>	Instrument Tray Two each of:
<b>RBG4027</b>	DeBakey Forceps, 9½" (242mm), Fine (2 in set)
<b>RB2659</b>	Pencil Grip Needle Holder, 17¼" (440mm)



## McCulloch Retractor Set

Catalog #	Description
RB2120	Set consists of one each: One each of RB2121 One each of RB2123 to RB2126 One each of RB2129 to RB2132 One each of RB2141 to RB2144 One each of RB2148 to RB2151 Tray not included. Set does not include shortest and longest of each blade and hook.

## McCulloch Retractor Body

Catalog #	Description	Angle
RB2121	Black coated	3" (75mm) max opening

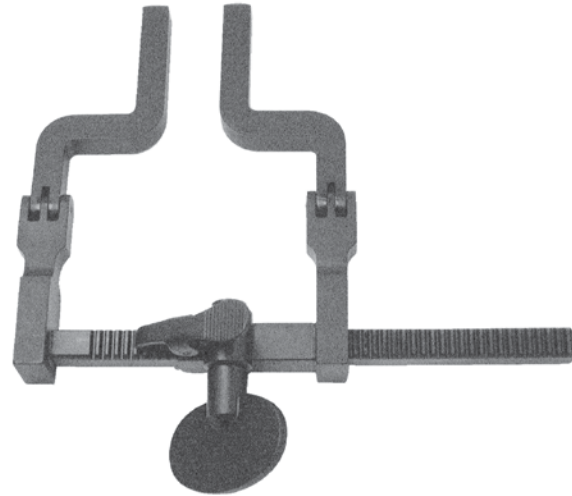

## McCulloch Retractor Tray

Catalog #
RBT2120



**McCulloch Narrow Muscle Blades (pair)**

Catalog #	Description
RB2122	30 x 20mm
RB2123	40 x 20mm
RB2124	50 x 20mm
RB2125	60 x 20mm
RB2126	70 x 20mm
RB2127	80 x 20mm



**McCulloch Wide Muscle Blades (pair)**

Catalog #	Description
RB2128	30 x 27mm
RB2129	40 x 27mm
RB2130	50 x 27mm
RB2131	60 x 27mm
RB2132	70 x 27mm
RB2133	80 x 27mm

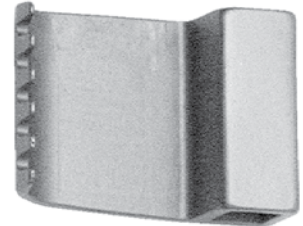

**McCulloch Hooks (each)**

Catalog #	Description
RB2140	20mm
RB2141	30mm
RB2142	40mm
RB2143	50mm
RB2144	60mm
RB2145	70mm

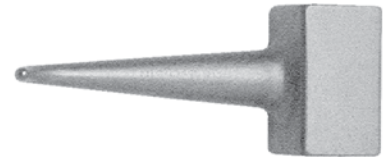

**McCulloch Multiple-Toothed Hooks (each)**

Catalog #	Description
RB2147	20mm
RB2148	30mm
RB2149	40mm
RB2150	50mm
RB2151	60mm
RB2152	70mm



### Silicone Retractors

clear reinforced with post

Catalog #	Length	Body
NL7702701	5" (127mm)	76 x 9mm
NL7702702	5" (127mm)	76 x 13mm
NL7702703	5" (127mm)	76 x 11mm
NL7702704	5" (127mm)	76 x 22mm
NL7702705	4 <sup>3</sup> / <sub>4</sub> " (121mm)	70 x 15mm
NL7702707	5 <sup>3</sup> / <sub>4</sub> " (146mm)	95 x 20mm
NL7702708	4 <sup>7</sup> / <sub>8</sub> " (124mm)	75 x 25mm

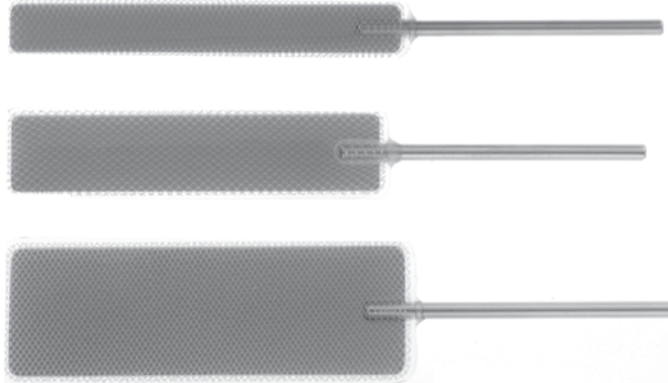

NL7702705

### NL8700200 Silicone Retractor, Hand-Held Set (5)

Includes one of each item below:

#### Silicone Retractors, Hand-Held

clear reinforced

Catalog #	Length	Body
NL8700204	8" (203mm)	1/4" (6mm)
NL8700206	8" (203mm)	3/8" (10mm)
NL8700208	8" (203mm)	1/2" (13mm)
NL8700210	8" (203mm)	5/8" (16mm)
NL8700214	8" (203mm)	7/8" (22mm)



NL8700208

**Silicone Retractors**

black coated with post

Catalog #	Style	Length	Blade
RNo711N	Narrow	5 <sup>7</sup> / <sub>8</sub> " (150mm)	6.5mm
RNo711W	Wide	5 <sup>7</sup> / <sub>8</sub> " (150mm)	10mm
RNo712N	Narrow	5 <sup>7</sup> / <sub>8</sub> " (150mm)	9mm
RNo712W	Wide	5 <sup>7</sup> / <sub>8</sub> " (150mm)	15mm
RNo713N	Narrow	5 <sup>7</sup> / <sub>8</sub> " (150mm)	11.5mm
RNo713W	Wide	5 <sup>7</sup> / <sub>8</sub> " (150mm)	20mm
RNo714N	Narrow	5 <sup>7</sup> / <sub>8</sub> " (150mm)	14mm
RNo714W	Wide	5 <sup>7</sup> / <sub>8</sub> " (150mm)	25.5mm



RNo713N



RNo714W

**RNo710 Silicone Retractor, Hand-Held Set (4)**

Includes one of each item below:

**Silicone Retractors, Hand-Held**

black coated, tapered

Catalog #	Style	Length	Size
RNo711	Small	6 <sup>3</sup> / <sub>4</sub> " (173mm)	6.5 x 10mm
RNo712	Medium	6 <sup>3</sup> / <sub>4</sub> " (173mm)	9 x 15mm
RNo713	Large	6 <sup>3</sup> / <sub>4</sub> " (173mm)	11.5 x 20mm
RNo714	X-Large	6 <sup>3</sup> / <sub>4</sub> " (173mm)	14 x 25mm



RNo713



RNo714

### Davis Spatulas, Malleable

Catalog #	Length	Width
Ro924	7" (178mm)	1/4" (6mm)
Ro925	7" (178mm)	3/8" (10mm)
Ro926	7" (178mm)	1/2" (13mm)
Ro927	7" (178mm)	5/8" (16mm)
Ro928	7" (178mm)	3/4" (19mm)
Ro929	7" (178mm)	7/8" (22mm)
Ro930	7" (178mm)	1" (25mm)



Ro925



Ro928



Ro930

### Davis Spatulas, Malleable

insulated, blue insulated coating

Catalog #	Length	Width
Ro924A	7" (178mm)	1/4" (6mm)
Ro925A	7" (178mm)	3/8" (10mm)
Ro926A	7" (178mm)	1/2" (13mm)
Ro927A	7" (178mm)	5/8" (16mm)
Ro928A	7" (178mm)	3/4" (19mm)
Ro929A	7" (178mm)	7/8" (22mm)
Ro930A	7" (178mm)	1" (25mm)



Ro924A



Ro927A

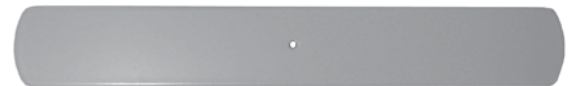

Ro930A

**T. Fukushima Spatulas**  
copper, Ebenol-C coated

Catalog #	Style	Length	Tip
R8959	Small	9" (226mm)	2.2mm
R8960	Medium	9" (226mm)	3.8mm
R8961	Large	9" (226mm)	5.8mm
R8998	X-Large	9" (226mm)	7mm



R8959



R8960



R8961



R8998

**T. Fukushima Dura Spatula**  
rigid, stainless steel

Catalog #	Style	Length	Tip
R8962	Curved, 60°	8" (205mm)	Cupped Tip
R8963	Small	8" (205mm)	2.2mm
R8964	Medium	8" (205mm)	3.8mm
R8999	Large	8" (205mm)	5.8mm
R8979	X-Large	8" (205mm)	7mm



R8962



R8963



R8964



R8999



R8979



**Scoville Nerve Root Retractors**

Catalog #	Description	Length	Blade Width
R1000	Straight	9 <sup>1</sup> / <sub>4</sub> " (235mm)	7.5mm
R1005	Angular	7" (178mm)	7.8mm



R1000



R1005

**D'Errico Nerve Root Retractor**

Catalog #	Length	Blade Width
RN2102	8 <sup>3</sup> / <sub>4</sub> " (225mm)	7.2mm

**Martin Nerve Root Retractor**

Catalog #	Length	Blade Width
R1007	7" (180mm)	6.5mm





**Love Bayonet Nerve Root Retractor**

Catalog #	Length	Blade Width
R1024	8 1/4" (210mm)	4.3mm



**Love Nerve Root Retractors**

Catalog #	Description	Length	Blade Width
R1025	90°	3 7/8" (99mm)	7mm
R1026	45°	6 1/2" (167mm)	7mm
R1027	Straight	7 3/4" (195mm)	7mm



R1025



R1026



R1027

**Holscher Nerve Root Retractors**

Catalog #	Length	Blade Width
RN2104	9 3/4" (245mm)	6.5mm
RN2105	9 3/4" (245mm)	13mm



RN2104



### Caspar Style Nerve Root Retractors

Catalog #	Length	Blade Width
R6322	9½" (244mm)	6mm
R6323	9½" (244mm)	8mm
R6324	9½" (244mm)	10mm

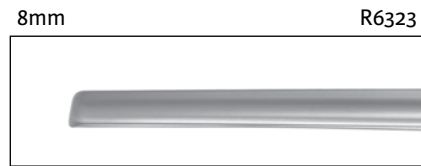

R6324

### Senn Retractor

double ended

Catalog #	Description	Length	3 Prong Blade Width	Solid Blade
R1297	Sharp	6¼" (159mm)	9mm	20 x 6.5mm
R1298	Blunt	6¼" (159mm)	9mm	20 x 6.5mm



R1298

**US Army Retractor**

double ended, set of 2

Catalog #	Length	Blade	Blade
R1093	8½" (216mm)	29 x 15mm	45 x 15mm



**Cushing Vein Retractor**

Catalog #	Description	Length	Blade Width
R1095	Solid Blade	9" (230mm)	11.4mm



**Cushing Decompression Retractor**

Catalog #	Description	Length	Blade Width
R1093	Fenestrated	8¾" (220mm)	12mm



**Meyerding Retractors**

Catalog #	Description	Length	Blade Width
RN2300	Small	8" (205mm)	50 x 16mm
RN2301	Medium	8¾" (225mm)	76 x 25mm
RN2302	Large	9¾" (250mm)	90 x 50mm



RN2300



### Taylor Spinal Retractors

Catalog #	Length	Blade
RN2320	7¼" (184mm)	77 x 32mm
RN2321	7¼" (184mm)	103 x 32mm
RN2322	7¼" (184mm)	77 x 19mm
RN2323	7¼" (184mm)	103 x 19mm



RN2320

### Cloward Type Blade Retractors

Catalog #	Length	Blade
R1060	7" (178mm)	83 x 18mm
R1061	7" (178mm)	83 x 18mm
R1062	7" (178mm)	83 x 18mm



R1062

### Cloward Type (Old Style) Blade Retractors

Catalog #	Length	Blade
RB2304	6¾" (174mm)	76 x 18mm
RB2305	6¾" (174mm)	76 x 18mm
RB2306	6¾" (174mm)	76 x 18mm



RB2305

**Cloward Type Cervical Vertebral Spreader**

Catalog #	Length	Tip Width
R1054	6" (152mm)	4mm



**Cervical Lamina Spreader, Improved**

Catalog #	Length	Tip Width
R1050	6¼" (156mm)	4.5mm



**Cloward Type Lamina Spreader**

Catalog #	Length	Tip Width
RN2673	5¼" (133mm)	3.2mm



**Cloward Type Cervical Vertebral Spreader with teeth**

Catalog #	Length	Tip Width
RB2308	6" (152mm)	3.5mm



### Inge Lamina Spreaders

Catalog #	Description	Length	Tip Width
R1075	Small	6½" (165mm)	7.2mm
R1070	Large	10½" (265mm)	11mm

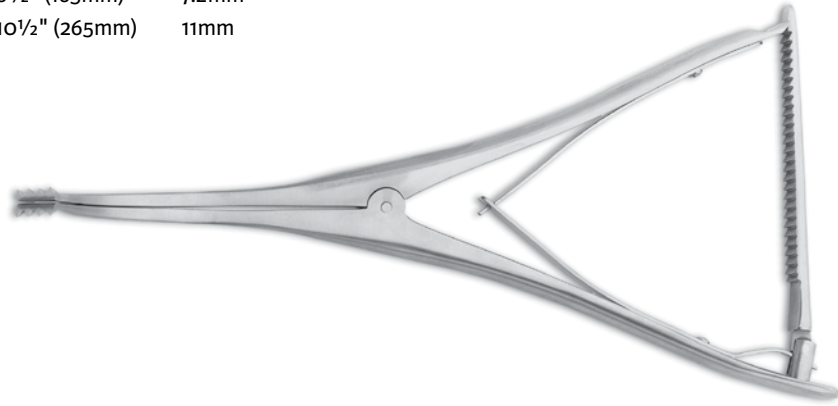

R1070

### Lamina Spreaders

2" jaw opening

Catalog #	Description	Length	Tip Width
RN2688	Flat Blades	10¾" (274mm)	17mm
RN2689	Concave Blades	11" (277mm)	16mm



RN2688

**Davis Scalp Retractor**  
bayonet

Catalog #	Description	Length
R1155	Blunt	4 <sup>5</sup> / <sub>8</sub> " (118mm)



**Snitman Retractor**  
3 x 3, sharp prongs

Catalog #	Length
RB2549	4 <sup>1</sup> / <sub>2</sub> " (114mm)



### Janetta Retractor Body

7" (178mm)

Catalog #	Blade Width
RN2401	18mm



### Janetta Double Round Bars

Catalog #	Description
RN2402	Double
RN2403	Single



RN2402



RN2403

### Janetta Malleable Blades

Catalog #	Blade Width
RN2404	70 x 15mm
RN2405	75 x 20mm
RN2406	75 x 25mm
RN2409	95 x 5mm
RN2407	95 x 10mm
RN2408	95 x 20mm



RN2404



RN2405



RN2406



RN2409



RN2407



RN2408



**Gelpi Perineal Retractors**

Catalog #	Length
RN2501	7¼" (185mm)
RN2502	5⅛" (130mm)
RN2503	4¾" (120mm)
RN2504	3⅝" (93mm)



RN2502

**Seltz-Gelpi Retractor**

sharp tips, curved arms

Catalog #	Length
RN2506	6½" (165mm)



**Markham-Meyerding Retractors**

Catalog #	Blade	Length	Blade Width
R1272	Right	6½" (165mm)	25 x 50mm
R1273	Left	6½" (165mm)	25 x 50mm



R1272

**Meyerding Retractors**

Catalog #	Length	Blades
R1275	7¾" (194mm)	60 x 25mm
R1280	7¾" (194mm)	54 x 25mm
R1285	7¾" (194mm)	31 x 25mm
R1290	7¾" (194mm)	63 x 19mm

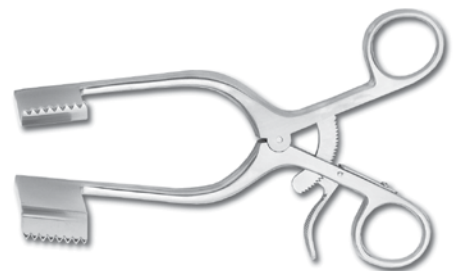

R1275

**Wiltse-Gelpi Retractor**

Catalog #	Length
RB2286	10¾" (273mm)

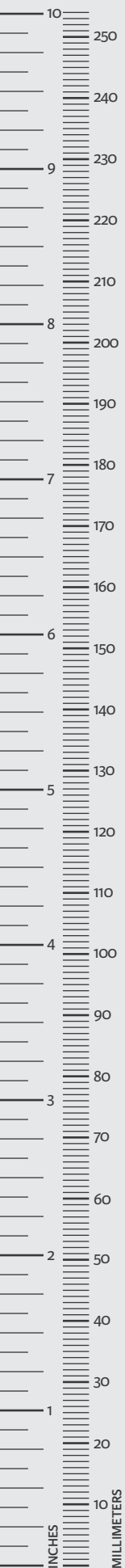
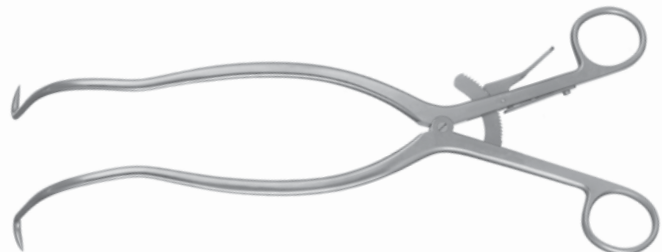

### Ducker Retractors

Catalog #	Blade	Length	Blades
RN2721	Left	6 <sup>3</sup> / <sub>4</sub> " (173mm)	50 x 20mm
RN2722	Right	6 <sup>3</sup> / <sub>4</sub> " (171mm)	50 x 20mm
RN2723	Left	6 <sup>3</sup> / <sub>4</sub> " (173mm)	70 x 20mm
RN2724	Right	6 <sup>3</sup> / <sub>4</sub> " (171mm)	70 x 20mm



RN2721

### Ducker Retractors, Double

Catalog #	Length	Blades
RN27225	7 <sup>1</sup> / <sub>2</sub> " (191mm)	61 x 21mm
RN27235	7 <sup>1</sup> / <sub>2</sub> " (191mm)	73 x 21mm

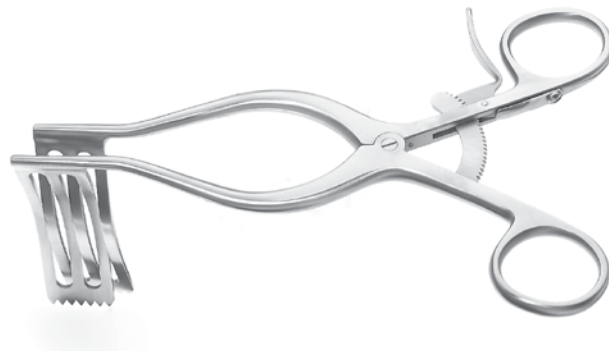

RN27235

### Ducker Retractor, Deep

Catalog #	Length	Blades
RN27245	7 <sup>1</sup> / <sub>2</sub> " (191mm)	90 x 20mm

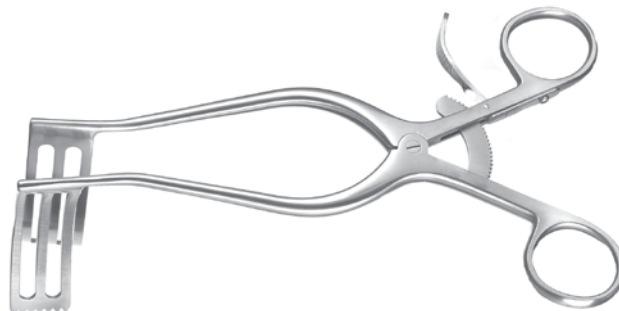

**Feler-Ducker Retractors**

Catalog #	Blade	Length	Blade
RN2726	Left	6¾" (173mm)	50 x 10mm
RN2727	Right	6¾" (173mm)	50 x 10mm
RN2728	Left	6¾" (173mm)	70 x 10mm
RN2729	Right	6¾" (173mm)	70 x 10mm

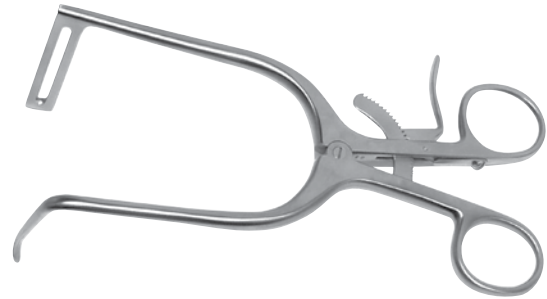

RN2729

**Williams Type Discectomy Retractors**

Catalog #	Style	Blade	Length	Blade
R7250	Narrow	Left	6¾" (171mm)	50 x 10mm
R7251	Narrow	Right	6¾" (171mm)	50 x 10mm
R7252	Narrow	Left	6¾" (171mm)	60 x 10mm
R7253	Narrow	Right	6¾" (171mm)	60 x 10mm
R7254	Narrow	Left	6¾" (171mm)	70 x 10mm
R7255	Narrow	Right	6¾" (171mm)	70 x 10mm
R7260	Wide	Left	6¾" (171mm)	50 x 20mm
R7261	Wide	Right	6¾" (171mm)	50 x 20mm
R7262	Wide	Left	6¾" (171mm)	60 x 20mm
R7263	Wide	Right	6¾" (171mm)	60 x 20mm
R7264	Wide	Left	6¾" (171mm)	70 x 20mm
R7265	Wide	Right	6¾" (171mm)	70 x 20mm



R7250



R7261

### Weitlaner Self-Retaining Retractors

2 x 3 prongs

Catalog #	Description	Length	Blade
R1220	Sharp	4 <sup>3</sup> / <sub>8</sub> " (110mm)	15.5 x 12mm
R1221	Blunt	4 <sup>3</sup> / <sub>8</sub> " (110mm)	15.5 x 12mm

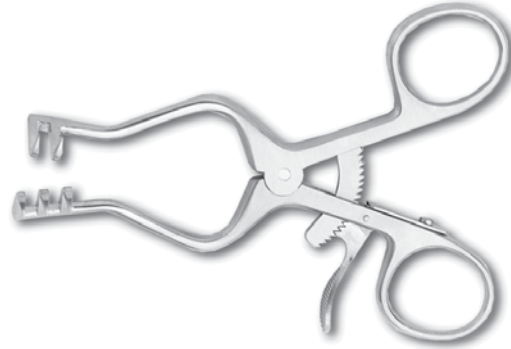

R1220

### Weitlaner Self-Retaining Retractors

3 x 4 prongs

Catalog #	Description	Length	Blade
R1200	Sharp	5 <sup>3</sup> / <sub>8</sub> " (135mm)	17 x 19mm
R1201	Blunt	5 <sup>3</sup> / <sub>8</sub> " (135mm)	17 x 19mm
R1205	Sharp	6 <sup>1</sup> / <sub>2</sub> " (165mm)	18 x 19mm
R1206	Blunt	6 <sup>1</sup> / <sub>2</sub> " (165mm)	18 x 19mm
R1210	Sharp	7 <sup>3</sup> / <sub>4</sub> " (195mm)	21 x 19mm
R1211	Blunt	7 <sup>3</sup> / <sub>4</sub> " (195mm)	21 x 19mm
R1215	Sharp	9 <sup>1</sup> / <sub>2</sub> " (240mm)	27 x 21mm
R1216	Blunt	9 <sup>1</sup> / <sub>2</sub> " (240mm)	27 x 21mm

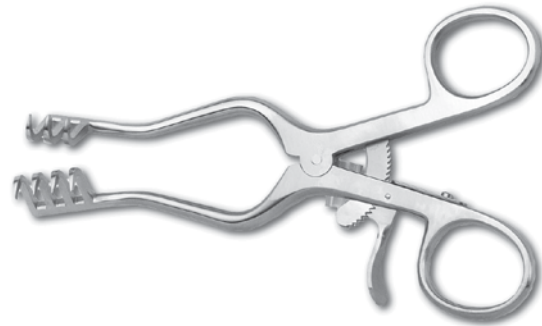

R1200

### Weitlaner Hinged Self-Retaining Retractors

3 x 4 prongs

Catalog #	Description	Length	Blade
R1225	Sharp	5 <sup>1</sup> / <sub>2</sub> " (140mm)	18 x 19mm
R1226	Blunt	5 <sup>1</sup> / <sub>2</sub> " (140mm)	18 x 19mm
R1230	Sharp	6 <sup>1</sup> / <sub>4</sub> " (162mm)	18 x 18.5mm
R1231	Blunt	6 <sup>1</sup> / <sub>4</sub> " (162mm)	18 x 18.5mm
RN2614	Sharp	8 <sup>1</sup> / <sub>4</sub> " (203mm)	20.5 x 21mm



R1225

### Weitlaner Angled Self-Retaining Retractors

3 x 4 prongs

Catalog #	Description	Length	Blade
R1208	Sharp	6½" (165mm)	19 x 19mm
R1209	Blunt	6½" (165mm)	19 x 19mm
R1217	Sharp	9½" (244mm)	21 x 26mm
R1218	Blunt	9½" (243mm)	21 x 27mm

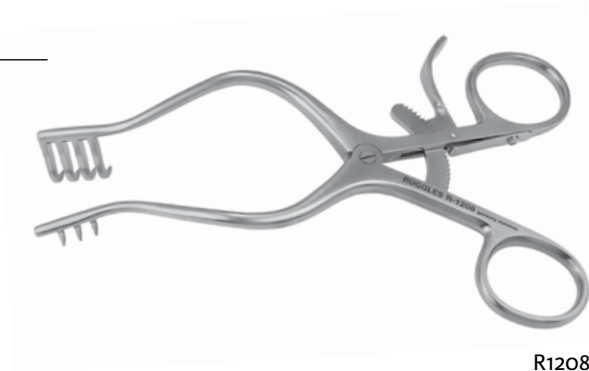

R1208

### Hoehn Retractor

body with two (2) sets of blades

Catalog #	Length	Blade 1	Blade 2
RN2536	10" (252mm)	75 x 24mm	53 x 45mm



### Miskimon Cerebellar Retractor

Catalog #	Description	Length	Blade
RN2540	Sharp, Prongs, Angled	7¾" (198mm)	32.5 x 34mm



### Adson Cerebellar Retractors

straight arms

Catalog #	Description	Length	Blade
R1189	Blunt	7 <sup>3</sup> / <sub>4</sub> " (195mm)	22.5 x 18.5mm
R1190	Sharp	7 <sup>3</sup> / <sub>4</sub> " (195mm)	22.5 x 18.5mm



R1190

### Adson Cerebellar Retractors

angled arms

Catalog #	Description	Length	Blade
R1194	Blunt	7 <sup>1</sup> / <sub>4</sub> " (182mm)	22.5 x 18.5mm
R1195	Sharp	7 <sup>1</sup> / <sub>4</sub> " (182mm)	22.5 x 18.5mm



R1194

### Anderson-Adson Cerebellar Retractor

Catalog #	Description	Length	Blade
R1197	Sharp	7 <sup>3</sup> / <sub>4</sub> " (197mm)	19 x 16mm

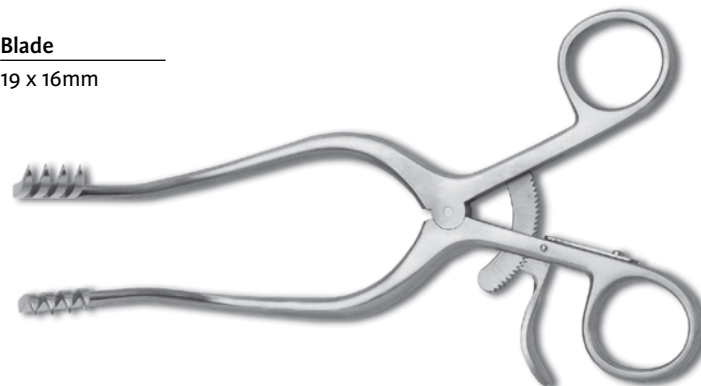

**Beckman-Adson Retractors**

hinged arms, 4 x 4 prongs

Catalog #	Description	Length	Blade
R1165	Blunt	12¼" (309mm)	29.5 x 28mm
R1166	Sharp	12¼" (309mm)	29.5 x 28mm
R1170	Wide, Sharp	12¼" (309mm)	48 x 28mm
RB2252	Wide, Blunt	12¼" (309mm)	48 x 28mm

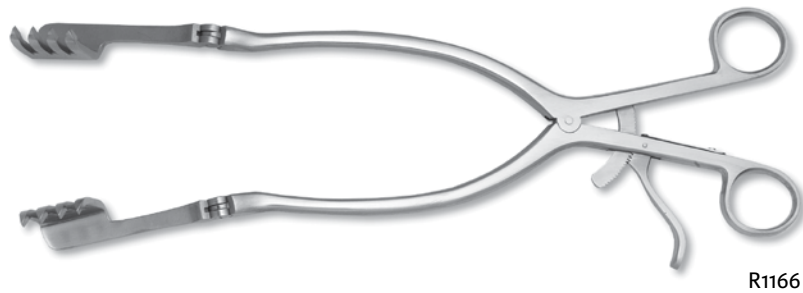

R1166

**Beckman-Eaton Retractor**

hinged arms, 7 x 7 prongs

Catalog #	Description	Length	Blade
R1175	Wide, Sharp	12¾" (325mm)	49 x 42mm

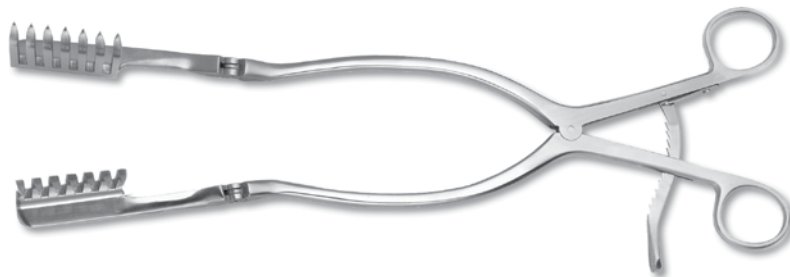

**Oberhill Retractor**

4 prong

Catalog #	Length	Blades
RN2528	12" (305mm)	38 x 25mm

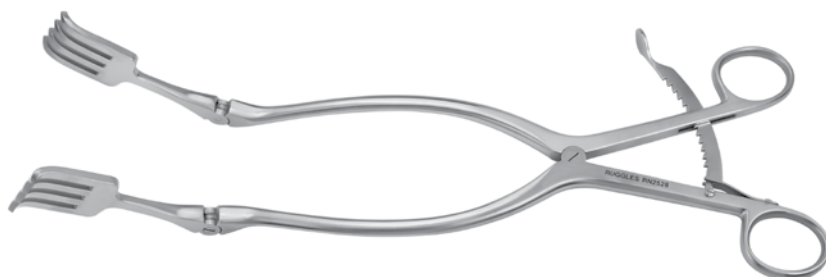

### Scoville Type Hemilaminectomy Retractor Body

Catalog #	Spread
R1106	7¼" (186mm)

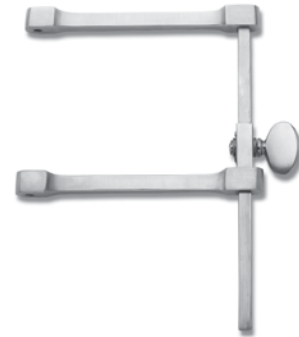

### Haverfield-Scoville Type Hemilaminectomy Retractor Body

Catalog #	Spread
R1111	7¼" (186mm)



### Scoville Type Hemilaminectomy Hooks with Cross Bar

Catalog #	Length
R1113	2¾" (61mm)
R1114	3⅛" (80mm)



R1113

### Scoville Type Hemilaminectomy Hooks without Cross Bar

Catalog #	Length
R1115	2¾" (61mm)
R1116	3⅛" (80mm)



R1115



**Scoville Type Hemilaminectomy Blades with teeth**

Catalog #	Width	Length
R1118	1" (25mm)	2½" (64mm)
R1119	2" (51mm)	2½" (64mm)
R1120	1¼" (32mm)	2⅝" (67mm)
R1121	1" (25mm)	3½" (89mm)



R1118

**Scoville Type Hemilaminectomy Blades with prongs**

Catalog #	Width	Length
R1123	1½" (38mm)	1⅝" (41mm)
R1124	1⅞" (48mm)	2⅝" (67mm)



R1123

**Meyerding Type Hemilaminectomy Blades**

Catalog #	Width	Length
R1126	1" (26mm)	2⅜" (61mm)
R1127	1" (26mm)	3" (76mm)
R1128	2" (51mm)	3½" (89mm)



R1127



### Taylor Type Hemilaminectomy Blades

single tooth

Catalog #	Width	Length
R1130	1¼" (32mm)	3" (76mm)
R1131	1¼" (32mm)	4" (102mm)



R1130

### Hibbs Type Hemilaminectomy Blades

with prongs

Catalog #	Width	Length
R1134	1" (26mm)	2" (51mm)
R1135	2" (51mm)	2" (51mm)
R1136	1" (26mm)	2½" (64mm)
R1137	1½" (39mm)	2½" (64mm)
R1138	1" (26mm)	3" (76mm)
R1139	1½" (38mm)	3" (75mm)
R1140	2" (51mm)	3" (75mm)
R1142	1" (25mm)	3½" (89mm)
R1143	1½" (38mm)	3½" (89mm)
R1144	1" (25mm)	4" (102mm)
R1145	2" (51mm)	4" (102mm)



R1135



R1142

### Taylor Type Hemilaminectomy Blades

with prongs

Catalog #	Description	Width	Length
R1146	3 Prong, Small	1½" (38mm)	1¾" (45mm)
R1147	4 Prong, Small	2" (51mm)	1⅞" (48mm)
R1148	4 Prong, Small	2½" (64mm)	2½" (64mm)
R1149	4 Prong, Small	2¼" (57mm)	3⅞" (79mm)



R1146

**Gardner-Wells Traction Tongs Set**

maximum opening of 8"

Catalog #	Description	Maximum Opening
R1945	Complete Set Includes: One (1) R1946, Test Bar 4¾" (121mm) Two (2) R1947, Fixation Screw One (1) R1949, "S" Hook Two (2) R1942, Lock Nuts	6¼" (159mm)



**Gardner-Wells Traction Tongs Set**

components

Catalog #	Description	Length
R1942	Lock Nuts	
R1946	Test Bar	4¾" (121mm)
R1947	Spring Load Screw, w/o Pressure Spring	3⅝" (93mm)
R1947SL	Spring Load Screw, w/Pressure Spring	3⅝" (93mm)
R1949	"S" Hook	3⅞" (97mm)



R1947

**Integra**<sup>®</sup>  
Rongeurs

**DeVilbiss Cranial Rongeur**

Catalog #	Description
R1300	8½" (216mm)

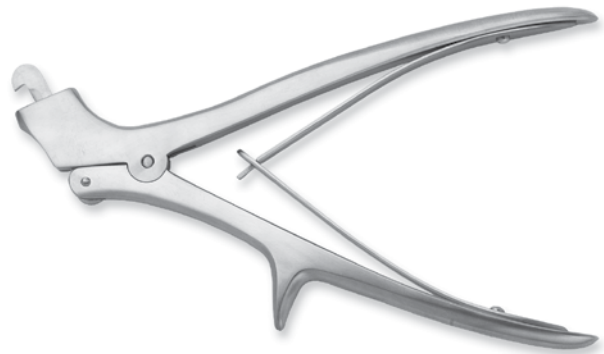

**Stille-Horsley Rongeur**

Catalog #	Description	Length	Jaw Length
R1307	Double Curved	9¾" (250mm)	26mm

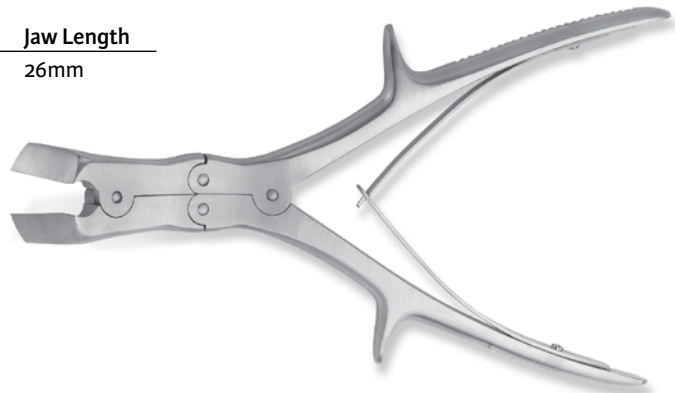

**Liston Bone Cutting Forceps**

Catalog #	Description	Length	Jaw Length
RB2064	Straight	5¾" (146mm)	24mm
RB2065	Straight	6½" (167mm)	26mm
RB2066	Straight	7½" (190mm)	39mm
RB2067	Straight	8¾" (220mm)	40mm
RB2068	Angled	5¾" (145mm)	23mm
RB2069	Angled	6½" (166mm)	26mm
RB2070	Angled	7½" (189mm)	40mm
RB2071	Angled	8½" (216mm)	40mm



RB2066



**Lempert Rongeurs**

single action

Catalog #	Description	Length	jaw Size	Bit Size
R1324	Straight	6¼" (158mm)	2.5 x 11mm	2mm
R1325	Curved	6¼" (158mm)	2.5 x 11mm	2mm
R1326	Straight	7½" (188mm)	2.5 x 11mm	2mm
R1327	Curved	7½" (188mm)	2.5 x 11mm	2mm

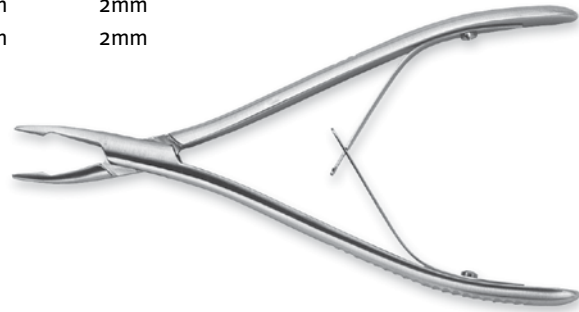

R1325

**Adson Rongeur**

single action

Catalog #	Description	Length	jaw Size	Bit Size
R1330	Straight	8¼" (212mm)	8 x 17mm	8mm

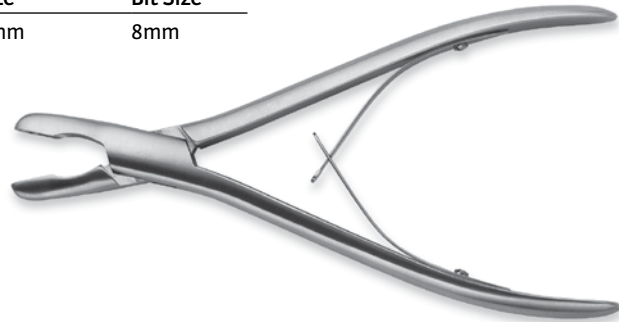

**Bacon Rongeur**

single action

Catalog #	Description	Length	jaw Size
RB2002	Angled	8" (204mm)	5 x 15mm



**Stille-Luer Rongeurs**

double action

Catalog #	Description	Length	Jaw Size
RN3022	Straight	8¾" (224mm)	10 x 16mm
RN3023	Short Length	8¾" (224mm)	10 x 16mm
RN3024	Short Length	10" (255mm)	10 x 16mm
RN3025	Medium Length	10" (253mm)	10 x 16mm



RN3024

**Stille-Luer Angular Duckbill Rongeur**

double action

Catalog #	Length	Jaw Size
RN3026	9" (230mm)	6 x 12.5mm



**Smith-Petersen Laminectomy Rongeurs**

double action

Catalog #	Description	Length	Jaw Size
R1381	Straight	9½" (242mm)	3 x 15.5mm
R1382	Slight Curve	9½" (242mm)	3 x 15.5mm
R1383	Full Curve	9½" (239mm)	3 x 15.5mm
R1386	Straight	8" (203mm)	3 x 15.5mm
R1387	Slight Curve	8" (203mm)	3 x 15.5mm
R1388	Full Curve	7½" (191mm)	3 x 15.5mm

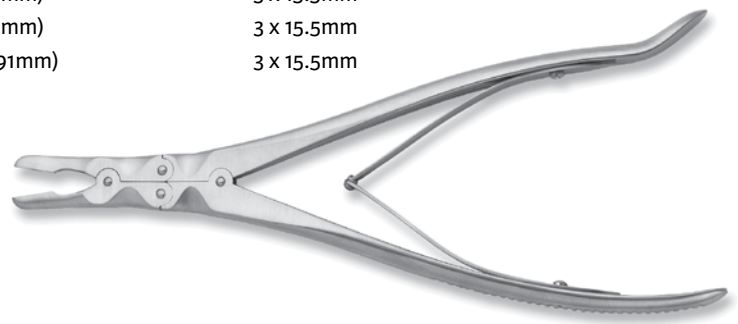

R1381

**Ruskin Rongeurs**

double action

Catalog #	Description	Length	Jaw Size
R1338	Straight	6" (155mm)	2 x 16.5mm
R1339	Curved	6" (155mm)	2 x 16.5mm
R1340	Straight	7¼" (185mm)	5 x 15mm
R1341	Curved	7¼" (185mm)	5 x 15mm
R1342	Straight	7¼" (185mm)	6 x 15mm
R1343	Curved	7¼" (185mm)	6 x 15mm
R1344	Duckbill	7¼" (185mm)	6 x 13.5mm



R1338

**Ruskin Rongeurs, Mini**

double action

Catalog #	Description	Length	Jaw Size
RB2014	Strong Curved	6" (152mm)	3 x 8.5mm

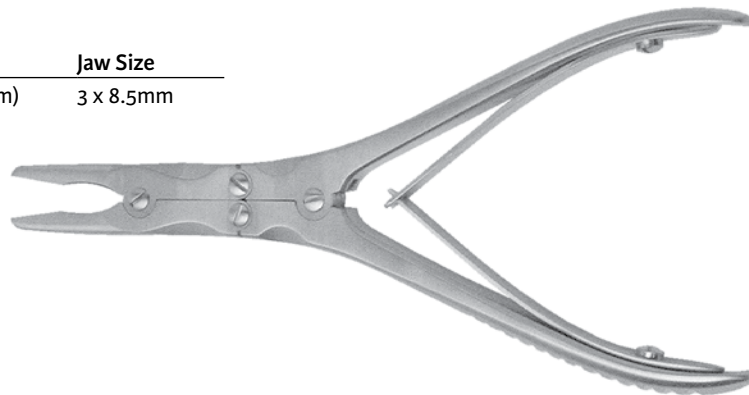

**Double Action Rongeur**

Catalog #	Length	Jaw Size
RB2047	14½" (368mm)	8 x 18mm

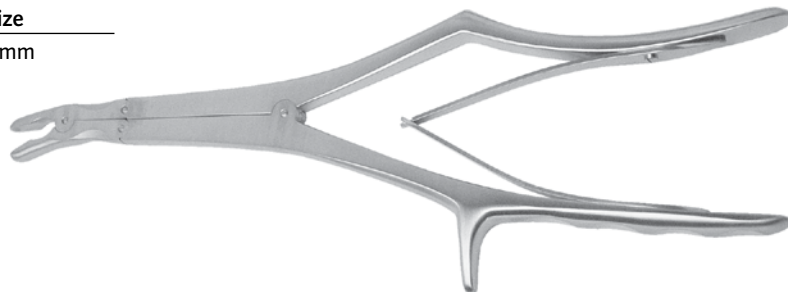



**Zaufel-Jansen Rongeur**

double action

Catalog #	Description	Length	Jaw Size
R1350	Curved	7" (179mm)	4mm



**Beyer Rongeur**

double action

Catalog #	Description	Length	Jaw Size
R1355	Curved	7" (178mm)	3 x 17.5mm

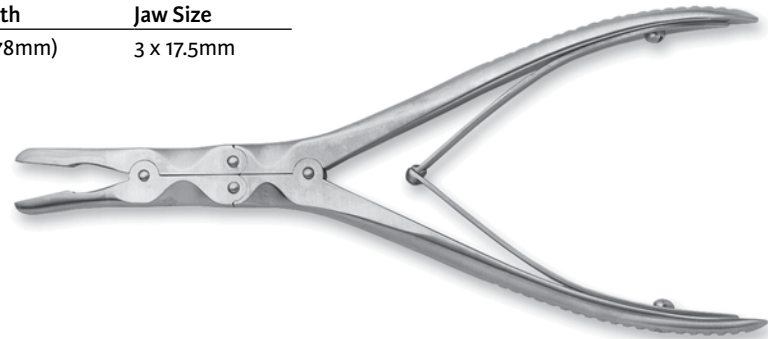

**Echlin Angular Duckbill Rongeurs**

double action

Catalog #	Length	Jaw Size
R1370	9" (230mm)	2 x 14mm
R1375	9" (230mm)	3 x 14mm
R1380	9" (230mm)	4 x 14mm

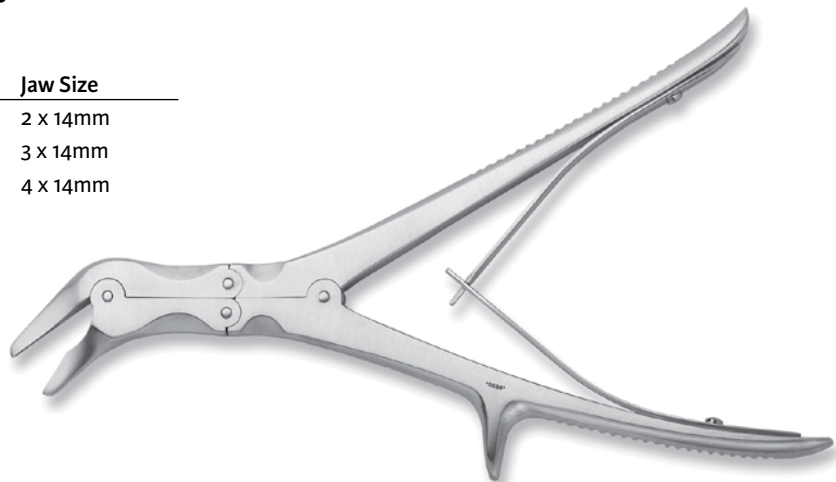

R1370



**Fulton Rongeurs**

double action

Catalog #	Description	Length	Jaw Size
R1390	Straight	9½" (241mm)	7mm
R1391	Slight Curve	9½" (241mm)	7mm
R1392	Full Curve	9½" (241mm)	7mm



R1390

**Leksell Rongeurs**

double action

Catalog #	Description	Length	Jaw Size
RN3032	Regular Curve	9¼" (237mm)	3 x 16mm
RN3031	Regular Curve	9¼" (237mm)	5 x 16mm
RN3030	Regular Curve	9¼" (237mm)	8 x 16mm
RN3035	Strong Curve	9¼" (234mm)	3 x 13.5mm
RN3034	Strong Curve	9¼" (234mm)	5 x 13.5mm
RN3033	Strong Curve	9¼" (234mm)	8 x 13.5mm

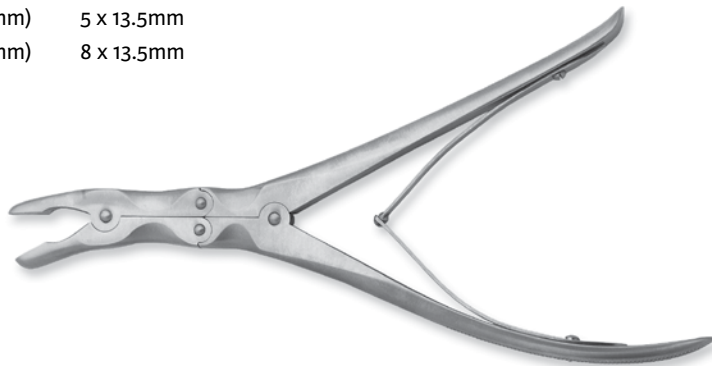

RN3030



RN3035

**Hercules Supercutter, Large**

8½" (216mm), 30° Blades

Tungsten-Carbide blades are replaceable.

Catalog #	Description
R3325	Cuts 3.0mm Wire, maximum capacity 0.118" (3mm)



Catalog #	Description
R3320	Replacement Blade Kit for R3325 includes: 1 Pair Tungsten Carbide Blades 4 Screws 1 Hexagonal Key

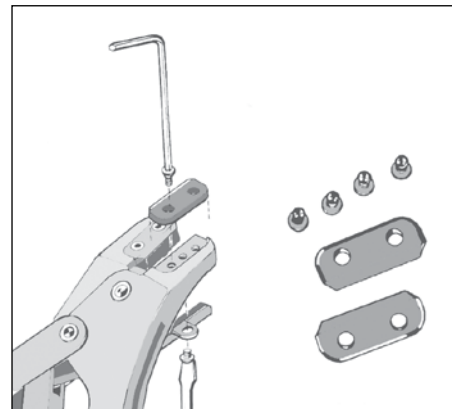

Catalog #	Description
R3321	Protective Shield for R3325 (Set of 2)

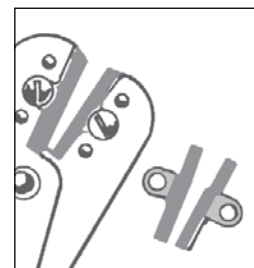

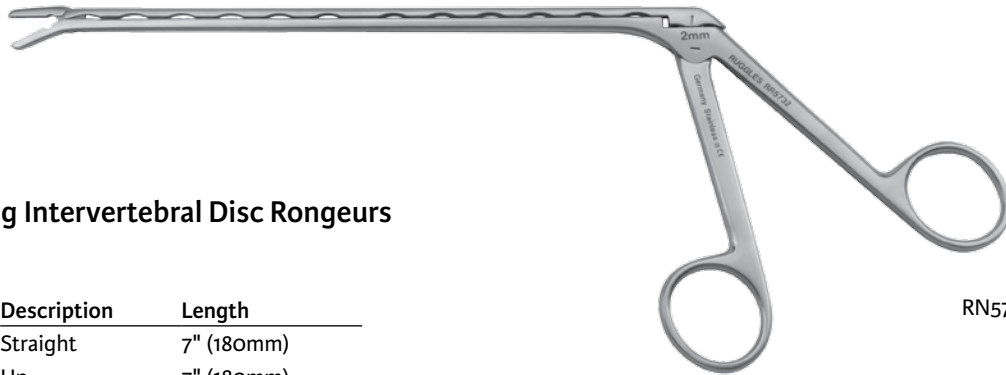

RN5732

### Wave Cushing Intervertebral Disc Rongeurs

2 x 10mm bite

Catalog #	Description	Length
RR5712	Straight	7" (180mm)
RR5722	Up	7" (180mm)
RR5732	Down	7" (180mm)
RR5912	Straight	9" (230mm)
RR5922	Up	9" (230mm)
RR5932	Down	9" (230mm)

### Wave Love-Gruenwald Intervertebral Disc Rongeurs

3 x 10mm bite

Catalog #	Description	Length
RR5743	Straight	7" (180mm)
RR5753	Up	7" (180mm)
RR5763	Down	7" (180mm)
RR5943	Straight	9" (230mm)
RR5953	Up	9" (230mm)
RR5963	Down	9" (230mm)

### Wave Spurling Intervertebral Disc Rongeurs

4 x 10mm bite

Catalog #	Description	Length
RR5744	Straight	7" (180mm)
RR5754	Up	7" (180mm)
RR5764	Down	7" (180mm)
RR5944	Straight	9" (230mm)
RR5954	Up	9" (230mm)
RR5964	Down	9" (230mm)

The Ultra-Coat™ Intervertebral Disc Rongeur has an extremely hard material coating that increases the surface hardness vs regular stainless steel IVD rongeurs, extending the life of the cutting edge.

### Ultra-Coat Bayonet Cushing IVD Rongeurs

Catalog #	Description	Working Length	Bite
RB6801	Straight	4 <sup>3</sup> / <sub>4</sub> " (120mm)	1.5 x 10mm
RB6802	Up	4 <sup>3</sup> / <sub>4</sub> " (120mm)	1.5 x 10mm
RB6803	Down	4 <sup>3</sup> / <sub>4</sub> " (120mm)	1.5 x 10mm
RB6804	Straight	4 <sup>3</sup> / <sub>4</sub> " (120mm)	2 x 10mm
RB6805	Up	4 <sup>3</sup> / <sub>4</sub> " (120mm)	2 x 10mm
RB6806	Down	4 <sup>3</sup> / <sub>4</sub> " (120mm)	2 x 10mm

### Ultra-Coat Bayonet Love-Gruenwald IVD Rongeurs

Catalog #	Description	Working Length	Bite
RB6821	Straight	4 <sup>3</sup> / <sub>4</sub> " (120mm)	3 x 10mm
RB6822	Up	4 <sup>3</sup> / <sub>4</sub> " (120mm)	3 x 10mm
RB6823	Down	4 <sup>3</sup> / <sub>4</sub> " (120mm)	3 x 10mm

### Ultra-Coat Bayonet Spurling IVD Rongeurs

Catalog #	Description	Working Length	Bite
RB6841	Straight	4 <sup>3</sup> / <sub>4</sub> " (120mm)	4 x 10mm
RB6842	Up	4 <sup>3</sup> / <sub>4</sub> " (120mm)	4 x 10mm
RB6843	Down	4 <sup>3</sup> / <sub>4</sub> " (120mm)	4 x 10mm

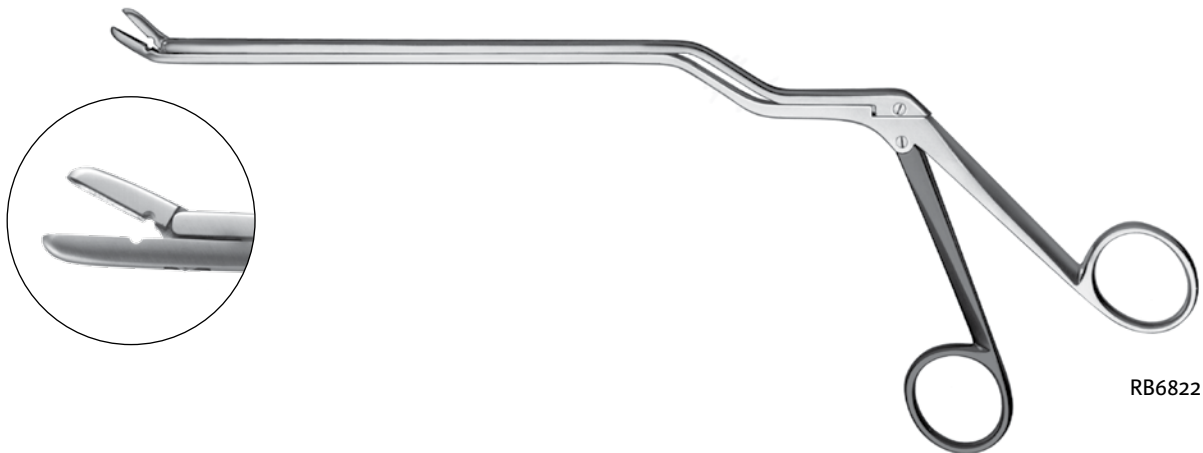

RB6822

The Diamond™ Intervertebral Disc Rongeur has a specific ceramic coating to make the surface harder vs. regular stainless steel, extending the life of the cutting edge and reduces intraoperative glare.

### Diamond Bayonet Cushing Intervertebral Disc Rongeurs

Catalog #	Description	Working Length	Bite
RD6811	Straight	8" (203mm)	1.5 x 10mm
RD6812	Up	8" (203mm)	1.5 x 10mm
RD6813	Down	8" (203mm)	1.5 x 10mm
RD6814	Straight	8" (203mm)	2 x 10mm
RD6815	Up	8" (203mm)	2 x 10mm
RD6816	Down	8" (203mm)	2 x 10mm

### Diamond Bayonet Love-Greunwald Intervertebral Disc Rongeurs

Catalog #	Description	Working Length	Bite
RD6831	Straight	8" (203mm)	3 x 10mm
RD6832	Up	8" (203mm)	3 x 10mm
RD6833	Down	8" (203mm)	3 x 10mm

### Diamond Bayonet Spurling Intervertebral Disc Rongeurs

Catalog #	Description	Working Length	Bite
RD6851	Straight	8" (203mm)	4 x 10mm
RD6852	Up	8" (203mm)	4 x 10mm
RD6853	Down	8" (203mm)	4 x 10mm



RD6831

**Love-Gruenwald Bayonet Intervertebral Disc Rongeurs**

Catalog #	Description	Working Length	Bite
RB6621	Straight	4¾" (120mm)	3 x 10mm
RB6622	Up	4¾" (120mm)	3 x 10mm
RB6623	Down	4¾" (120mm)	3 x 10mm

**Spurling Bayonet Intervertebral Disc Rongeurs**

Catalog #	Description	Working Length	Bite
RB6641	Straight	4¾" (120mm)	4 x 10mm
RB6642	Up	4¾" (120mm)	4 x 10mm
RB6643	Down	4¾" (120mm)	4 x 10mm

**Spurling Bayonet Intervertebral Disc Rongeurs**

Catalog #	Description	Working Length	Bite
RB6601	Straight	4¾" (120mm)	1.5 x 10mm
RB6602	Up	4¾" (120mm)	1.5 x 10mm
RB6603	Down	4¾" (120mm)	1.5 x 10mm
RB6604	Straight	4¾" (120mm)	2 x 10mm
RB6605	Up	4¾" (120mm)	2 x 10mm
RB6606	Down	4¾" (120mm)	2 x 10mm

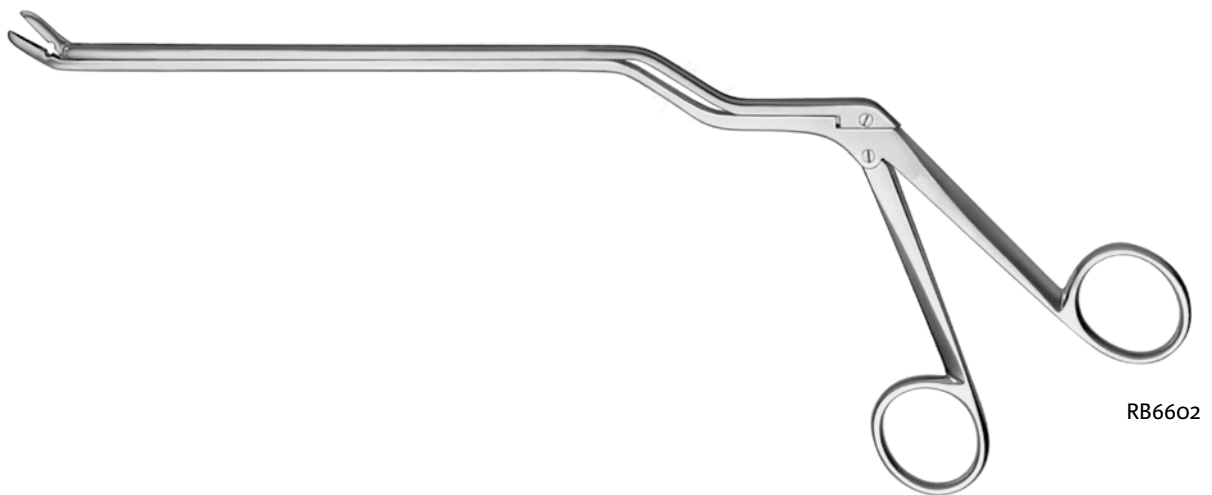

RB6602

**Cushing Intervertebral Disc Rongeurs**

delicate pattern, 2 x 10mm bite

Catalog #	Description	Length
RN5712	Straight	7" (178mm)
RN5712X	Straight w/ Teeth	7" (178mm)
RN5722	Up	7" (178mm)
RN5722X	Up w/ Teeth	7" (178mm)
RN5732	Down	7" (178mm)



RN5712

**Cushing Intervertebral Disc Rongeurs**

1.5 x 10mm bite

Catalog #	Length	Catalog #	Length	Catalog #	Length
RN5680	6" (152mm)	RN5780	7" (178mm)	RN5980	9" (229mm)
RN5681	6" (152mm)	RN5781	7" (178mm)	RN5981	9" (229mm)
RN5682	6" (152mm)	RN5782	7" (178mm)	RN5982	9" (229mm)

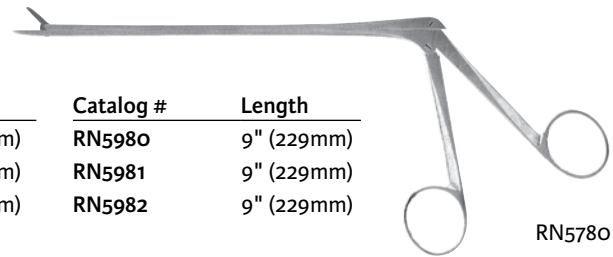

RN5780

**Cushing Intervertebral Disc Rongeurs**

2 x 10mm bite

Catalog #	Description	Length	Catalog #	Description	Length
RN5512H	Straight	5 1/8" (130mm)	RN5612H	Straight	9" (230mm)
RN5522H	Up	5 1/8" (130mm)	RN5622H	Up	9" (230mm)
RN5532H	Down	5 1/8" (130mm)	RN5632H	Down	9" (230mm)
RN5612H	Straight	5 7/8" (150mm)	RB6246	Straight	10" (254mm)
RN5622H	Up	5 7/8" (150mm)	RB6247	Up	10" (254mm)
RN5632H	Down	5 7/8" (150mm)	RB6248	Down	10" (254mm)
RN5622X	Up w/Teeth	5 7/8" (150mm)			
RN5712H	Straight	7" (180mm)	RN51112H	Straight	11" (280mm)
RN5722H	Up	7" (180mm)	RN51122H	Up	11" (280mm)
RN5732H	Down	7" (180mm)	RN51132H	Down	11" (280mm)
RR5712X	Straight w/Teeth	7" (180mm)	RN51212H	Straight	12" (305mm)
RR5722X	Up w/Teeth	7" (180mm)	RN51222H	Up	12" (305mm)
RN5732X	Down w/Teeth	7" (180mm)	RN51232H	Down	12" (305mm)

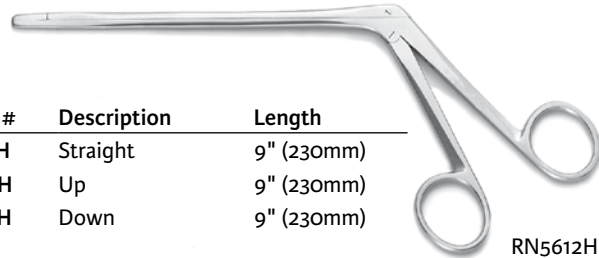

RN5612H



**Love-Gruenwald Intervertebral Disc Rongeurs**

delicate pattern, 3 x 10mm bite

Catalog #	Description	Length
RN5743	Straight	7" (178mm)
RN5743X	Straight w/Teeth	7" (178mm)
RN5753	Up	7" (178mm)
RN5753X	Up w/Teeth	7" (178mm)
RN5763	Down	7" (178mm)
RN5763X	Down w/Teeth	7" (178mm)



RN5763

**Love-Gruenwald Intervertebral Disc Rongeurs**

3 x 10mm bite

Catalog #	Description	Length	Catalog #	Description	Length
RN5543H	Straight	5 1/8" (130mm)	RN5943H	Straight	9" (230mm)
RN5553H	Up	5 1/8" (130mm)	RN5953H	Up	9" (230mm)
RN5563H	Down	5 1/8" (130mm)	RN5963H	Down	9" (230mm)
RN5643H	Straight	5 7/8" (150mm)	RB6249	Straight	10" (254mm)
RN5653H	Up	5 7/8" (150mm)	RB6250	Up	10" (254mm)
RN5663H	Down	5 7/8" (150mm)	RB6251	Down	10" (254mm)
RN5743H	Straight	7" (180mm)	RN51143H	Straight	11" (280mm)
RN5753H	Up	7" (180mm)	RN51153H	Up	11" (280mm)
RN5763H	Down	7" (180mm)	RN51163H	Down	11" (280mm)
RN5743HX	Straight w/Teeth	7" (180mm)	RN51243H	Straight	12" (305mm)
RN5753HX	Up w/Teeth	7" (180mm)	RN51253H	Up	12" (305mm)
RN5763HX	Down w/Teeth	7" (180mm)	RN51263H	Down	12" (305mm)

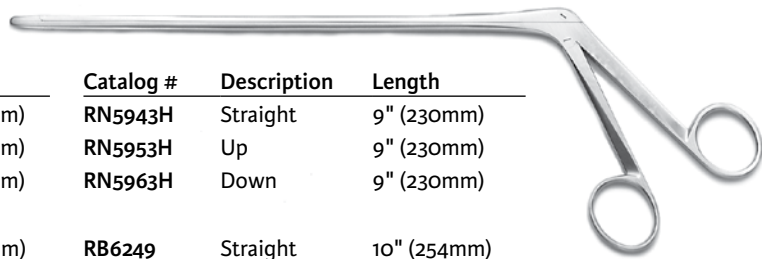

RN5943H

**Spurling Intervertebral Disc Rongeurs**

3 x 10mm bite

Catalog #	Description	Length
R1758	Angled Tip Left	7" (178mm)
R1759	Angled Tip Right	7" (178mm)



R1758

**Spurling Intervertebral Disc Rongeurs**

Catalog #	Description	Length
RN5744	Straight	7" (178mm)
RN5744X	Straight w/Teeth	7" (178mm)
RN5754	Up	7" (178mm)
RN5754X	Up w/Teeth	7" (178mm)
RN5764	Down	7" (178mm)
RN5764X	Down w/Teeth	7" (178mm)



RN5744

**Spurling Intervertebral Disc Rongeurs**

4 x 10mm bite

Catalog #	Description	Length	Catalog #	Description	Length
RN5544H	Straight	5 1/8" (130mm)	RN5944H	Straight	9" (230mm)
RN5544H	Up	5 1/8" (130mm)	RN5944H	Up	9" (230mm)
RN5563H	Down	5 1/8" (130mm)	RN5964H	Down	9" (230mm)
RN5644H	Straight	5 7/8" (150mm)	RB6252	Straight	10" (254mm)
RN5654H	Up	5 7/8" (150mm)	RB6253	Up	10" (254mm)
RN5664H	Down	5 7/8" (150mm)	RB6254	Down	10" (254mm)
RN5744H	Straight	7" (180mm)	RN51144H	Straight	11" (280mm)
RN5754H	Up	7" (180mm)	RN51154H	Up	11" (280mm)
RN5764H	Down	7" (180mm)	RN51164H	Down	11" (280mm)
RB6307	Straight w/Teeth	7" (180mm)	RN51244H	Straight	12" (305mm)
RB6308	Up w/Teeth	7" (180mm)	RN51254H	Up	12" (305mm)
RB6309	Down w/Teeth	7" (180mm)	RN51264H	Down	12" (305mm)



RN5744H

**Peapod Intervertebral Disc Rongeurs**

Catalog #	Description	Length	Bite
RB6126	Small	5½" (140mm)	2 x 7mm
RN5526	Small	5½" (140mm)	2.5 x 7mm
RN5527	Medium	5½" (140mm)	3 x 7mm
RN5528	Large	5½" (140mm)	4 x 7mm
R1722	Small	7" (178mm)	2.5 x 7mm
R1723	Medium	7" (178mm)	3 x 7mm
R1724	Large	7" (178mm)	4 x 7mm



RN5526

**Poppen Intervertebral Disc Rongeurs**

Catalog #	Description	Length
R1785	Straight	5" (127mm)
R1786	Up	5" (127mm)
R1787	Down	5" (127mm)
R1765	Straight	7" (178mm)
R1766	Up	7" (178mm)
R1767	Down	7" (178mm)



R1785

**Intervertebral Disc Rongeurs**

5 x 10mm bite

Catalog #	Description	Length
R18045	Straight	9" (228mm)
R18055	Up	9" (228mm)
R18065	Down	9" (228mm)
R18165	Straight	11" (279mm)
R18175	Up	11" (279mm)
R18185	Down	11" (279mm)
R18615	Straight	12" (305mm)
R18625	Up	12" (305mm)
R18635	Down	12" (305mm)



R18185

**Wilde Intervertebral Disc Rongeurs**

fenestrated

Catalog #	Description	Length	Bite
R1711	Straight	7" (178mm)	2.5 x 7mm
R1712	Straight	7" (178mm)	3 x 8mm
R1713	Straight	7" (178mm)	4 x 9mm
R1714	Straight	7" (178mm)	5 x 11mm
R1716	Angled Up	7" (178mm)	2.5 x 7mm
R1717	Angled Up	7" (178mm)	3 x 9mm
R1718	Angled Up	7" (178mm)	4 x 9mm
R1719	Angled Up	7" (178mm)	5 x 12mm
R1711L	Long Jaw, Straight	7" (180mm)	2.5 x 7mm
R1712L	Long Jaw, Straight	7" (180mm)	3 x 7.5mm
R1713L	Long Jaw, Straight	7" (180mm)	4 x 9mm
R1714L	Long Jaw, Straight	7" (180mm)	5 x 11mm
R1716L	Long Jaw, Angled Up	7" (180mm)	2.5 x 7mm
R1717L	Long Jaw, Angled Up	7" (180mm)	3 x 7.5mm
R1718L	Long Jaw, Angled Up	7" (180mm)	4 x 9mm
R1719L	Long Jaw, Angled Up	7" (180mm)	5 x 11mm

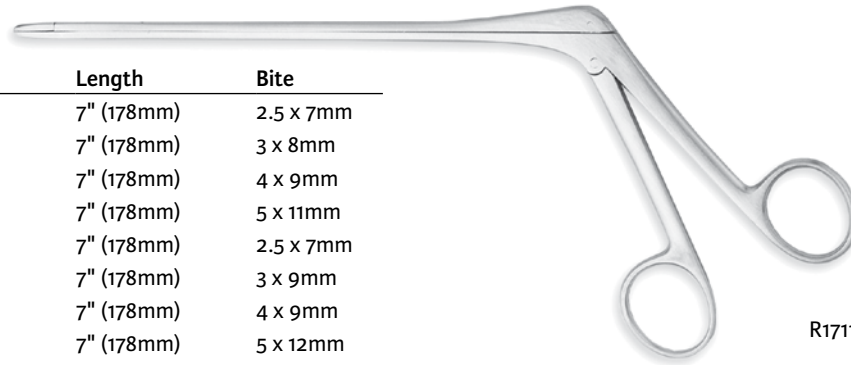

R1711

**Wilde Intervertebral Disc Rongeurs**

fenestrated, delicate pattern

Catalog #	Description	Length	Bite
RN5603	Straight	5½" (140mm)	4 x 9mm
RN5604	Straight	5½" (140mm)	5 x 11mm
RN5605	Straight	5½" (140mm)	6 x 11mm
RN5703	Straight	7" (178mm)	3 x 8mm
RN5704	Straight	7" (178mm)	4 x 9mm
RN5705	Straight	7" (178mm)	5 x 11mm
RN5903	Straight	9" (229mm)	3 x 8mm
RN5904	Straight	9" (229mm)	4 x 9mm
RN5905	Straight	9" (229mm)	5 x 11mm



RN5705

**Caspar Intervertebral Disc Rongeurs**

double fenestrated with teeth

Catalog #	Description	Length	Bite
RB6401	Straight	6¼" (159mm)	2 x 12mm
RB6402	Straight	6¼" (159mm)	3 x 12mm
RB6403	Straight	6¼" (159mm)	4 x 14mm
RB6404	Straight	6¼" (159mm)	5 x 14mm
RB6405	Straight	6¼" (159mm)	6 x 12mm
RB6406	Up	6¼" (159mm)	3 x 12mm
RB6407	Up	6¼" (159mm)	4 x 14mm
RB6408	Up	6¼" (159mm)	5 x 14mm
RB6409	Down	6¼" (159mm)	3 x 12mm
RB6410	Down	6¼" (159mm)	4 x 14mm
R18402	Straight	7" (180mm)	2 x 12mm
R18403	Straight	7" (180mm)	3 x 12mm
R18404	Straight	7" (180mm)	4 x 14mm
R18405	Straight	7" (180mm)	5 x 14mm
RB6415	Straight	7" (180mm)	6 x 16mm
R18453	Up	7" (180mm)	3 x 12mm
R18454	Up	7" (180mm)	4 x 14mm
R18455	Up	7" (180mm)	5 x 14mm
R18503	Down	7" (180mm)	3 x 12mm
R18504	Down	7" (180mm)	4 x 14mm



R18402



**Jackson Intervertebral Disc Rongeur**

4 x 8mm bite

Catalog #	Description	Length
R1745	70° Up	7" (178mm)



**Williams Style Micro Disc IVD Rongeurs**

delicate pattern, 1 x 2 teeth

Catalog #	Description	Length
RN7132	Straight	5½" (140mm)
RB6154	Straight	7" (178mm)
RB6155	Straight	10" (254mm)



RB6154

**Ferris-Smith Intervertebral Disc Rongeurs**

Catalog #	Description	Length	Bite
RN5802	Straight	7" (177mm)	2 x 10mm
RN5803	Straight	7" (177mm)	3 x 10mm
RN5808	Straight	7" (177mm)	4 x 8mm
RN5804	Straight	7" (177mm)	4 x 10mm
RN5806	Straight	7" (177mm)	6 x 10mm
RN5805	Straight	7" (177mm)	6 x 12mm
RN5812	Up	7" (177mm)	2 x 10mm
RN5813	Up	7" (177mm)	3 x 10mm
RN5814	Up	7" (177mm)	4 x 10mm
RN5816	Up	7" (177mm)	6 x 10mm
RN5822	Down	7" (177mm)	2 x 10mm
RN5823	Down	7" (177mm)	3 x 10mm
RN5824	Down	7" (177mm)	4 x 10mm
RN5826	Down	7" (177mm)	6 x 10mm

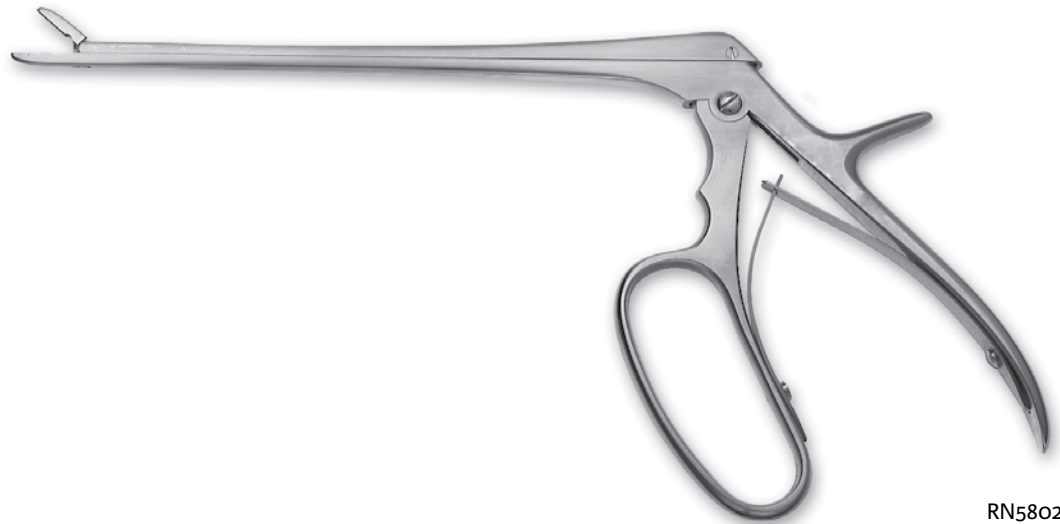

RN5802

**Decker Intervertebral Disc Rongeurs**

2 x 6mm bite

Catalog #	Description	Length
RN7127	Right	6" (153mm)
RN7128	Left	6" (153mm)
RN7129	Down	6" (153mm)
RN7130	Up	6" (153mm)
RN7131	Straight	6" (153mm)



RN7131

The Ultra-Coat™ Kerrison rongeurs have an extremely hard material coating that increases the surface hardness vs regular stainless steel kerrison rongeurs, extending the life of the cutting edge.

- Coating greatly reduces the frequency of sharpening and lowers replacement costs
- The surface smoothness enhances the sliding action
- Features a unique thin footplate design that facilitates easy insertion, without compromising tip strength

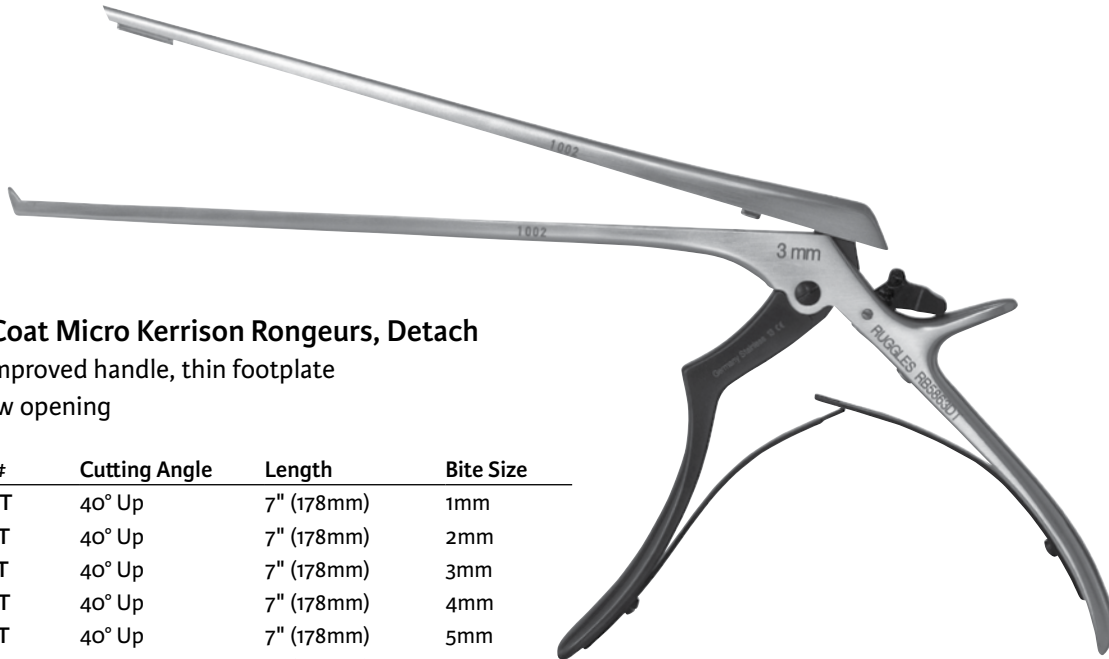

**Ultra-Coat Micro Kerrison Rongeurs, Detach**

small, improved handle, thin footplate

9mm jaw opening

Catalog #	Cutting Angle	Length	Bite Size
RB5760DT	40° Up	7" (178mm)	1mm
RB5762DT	40° Up	7" (178mm)	2mm
RB5763DT	40° Up	7" (178mm)	3mm
RB5764DT	40° Up	7" (178mm)	4mm
RB5765DT	40° Up	7" (178mm)	5mm
RB5766DT	40° Up	7" (178mm)	6mm
RB5860DT	40° Up	8" (200mm)	1mm
RB5862DT	40° Up	8" (200mm)	2mm
RB5863DT	40° Up	8" (200mm)	3mm
RB5864DT	40° Up	8" (200mm)	4mm
RB5865DT	40° Up	8" (200mm)	5mm
RB5866DT	40° Up	8" (200mm)	6mm
RB5960DT	40° Up	9" (229mm)	1mm
RB5962DT	40° Up	9" (229mm)	2mm
RB5963DT	40° Up	9" (229mm)	3mm
RB5964DT	40° Up	9" (229mm)	4mm
RB5965DT	40° Up	9" (229mm)	5mm
RB5966DT	40° Up	9" (229mm)	6mm
RB5160DT	40° Up	11" (279mm)	1mm
RB5162DT	40° Up	11" (279mm)	2mm
RB5163DT	40° Up	11" (279mm)	3mm
RB5164DT	40° Up	11" (279mm)	4mm
RB5165DT	40° Up	11" (279mm)	5mm
RB5166DT	40° Up	11" (279mm)	6mm

RB5863DT



**Ultra-Coat Micro Kerrison Rongeurs**

small, improved handle, thin footplate  
9mm jaw opening

Catalog #	Cutting Angle	Length	Bite Size
RB5760	40° Up	7" (178mm)	1mm
RB5761	40° Up	7" (178mm)	1.5mm
RB5762	40° Up	7" (178mm)	2mm
RB5763X	40° Up	7" (178mm)	3mm
RB5764X	40° Up	7" (178mm)	4mm
RB5765	40° Up	7" (178mm)	5mm
RB5766	40° Up	7" (178mm)	6mm
RB5860	40° Up	8" (203mm)	1mm
RB5861	40° Up	8" (203mm)	1.5mm
RB5862	40° Up	8" (203mm)	2mm
RB5863	40° Up	8" (203mm)	3mm
RB5864	40° Up	8" (203mm)	4mm
RB5865	40° Up	8" (203mm)	5mm
RB5866	40° Up	8" (203mm)	6mm
RB5960	40° Up	9" (229mm)	1mm
RB5961	40° Up	9" (229mm)	1.5mm
RB5962	40° Up	9" (229mm)	2mm
RB5963	40° Up	9" (229mm)	3mm
RB5964	40° Up	9" (229mm)	4mm
RB5965	40° Up	9" (229mm)	5mm
RB5966	40° Up	9" (229mm)	6mm
RB5062	40° Up	10" (254mm)	2mm
RB5063	40° Up	10" (254mm)	3mm
RB5064	40° Up	10" (254mm)	4mm
RB5065	40° Up	10" (254mm)	5mm
RB5066	40° Up	10" (254mm)	6mm
RB5162	40° Up	11" (280mm)	2mm
RB5163	40° Up	11" (280mm)	3mm
RB5164	40° Up	11" (280mm)	4mm
RB5165	40° Up	11" (280mm)	5mm
RB5166	40° Up	11" (280mm)	6mm
RB5362	40° Up	13" (330mm)	2mm
RB5363	40° Up	13" (330mm)	3mm
RB5364	40° Up	13" (330mm)	4mm
RB5365	40° Up	13" (330mm)	5mm
RB5366	40° Up	13" (330mm)	6mm

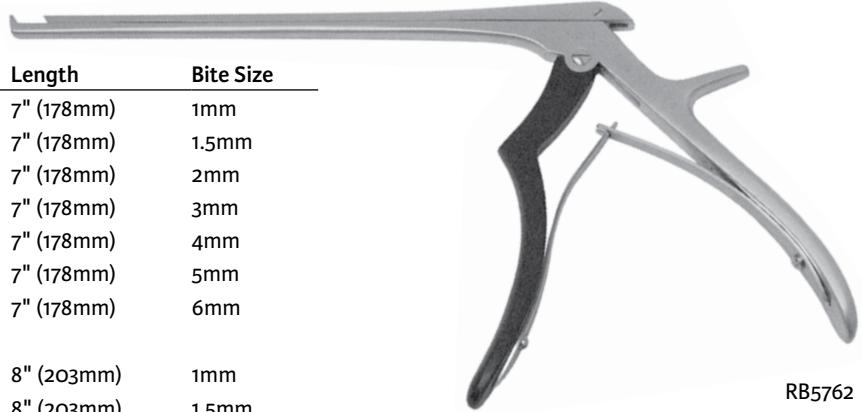

RB5762

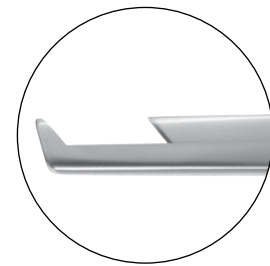

**Ultra-Coat Micro Kerrison Rongeurs, Ejector**

small, improved handle, thin footplate, pin ejector  
9mm jaw opening

Catalog #	Cutting Angle	Length	Bite Size
RB5882	40° Up	8" (203mm)	2mm
RB5883	40° Up	8" (203mm)	3mm
RB5884	40° Up	8" (203mm)	4mm
RB5885	40° Up	8" (203mm)	5mm



**Ultra-Coat Micro Kerrison Rongeurs, Bayonet**

small, improved handle, thin footplate  
9mm jaw opening

Catalog #	Cutting Angle	Working Length	Bite Size
RB5562	40° Up	4¾" (120mm)	2mm
RB5563	40° Up	4¾" (120mm)	3mm
RB5564	40° Up	4¾" (120mm)	4mm
RB5565	40° Up	4¾" (120mm)	5mm
RB5566	40° Up	4¾" (120mm)	6mm
RB5662	40° Up	8" (203mm)	2mm
RB5663	40° Up	8" (203mm)	3mm
RB5664	40° Up	8" (203mm)	4mm
RB5665	40° Up	8" (203mm)	5mm
RB5666	40° Up	8" (203mm)	6mm



**Ultra-Coat Micro Kerrison Rongeurs, Bayonet, Ejector**

small, improved handle, thin footplate  
9mm jaw opening

Catalog #	Cutting Angle	Working Length	Bite Size
RB5582	40° Up	4¾" (120mm)	2mm
RB5583	40° Up	4¾" (120mm)	3mm
RB5584	40° Up	4¾" (120mm)	4mm
RB5585	40° Up	4¾" (120mm)	5mm
RB5586	40° Up	4¾" (120mm)	6mm

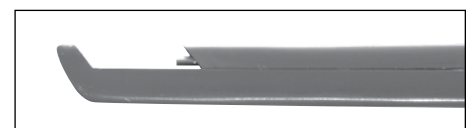

**Ultra-Coat Medium Kerrison Rongeurs, Detach**

small, improved handle, thin footplate

15mm jaw opening

Catalog #	Cutting Angle	Length	Bite Size
RB5860DTM	40° Up	8" (200mm)	1mm
RB5862DTM	40° Up	8" (200mm)	2mm
RB5863DTM	40° Up	8" (200mm)	3mm
RB5864DTM	40° Up	8" (200mm)	4mm
RB5865DTM	40° Up	8" (200mm)	5mm
RB5866DTM	40° Up	8" (200mm)	6mm



RB5863DTM

**Ultra-Coat Medium Kerrison Rongeurs**

small, improved handle, thin footplate

15mm jaw opening

Catalog #	Cutting Angle	Length	Bite Size
RB5860M	40° Up	8" (203mm)	1mm
RB5862M	40° Up	8" (203mm)	2mm
RB5863M	40° Up	8" (203mm)	3mm
RB5864M	40° Up	8" (203mm)	4mm
RB5865M	40° Up	8" (203mm)	5mm
RB5866M	40° Up	8" (203mm)	6mm



RB5864M

**Ultra-Coat Spurling Kerrison Rongeurs**

large, improved handle, thin footplate

15mm jaw opening

Catalog #	Cutting Angle	Length	Bite Size
RB5772	40° Up	7" (178mm)	2mm
RB5773	40° Up	7" (178mm)	3mm
RB5774	40° Up	7" (178mm)	4mm
RB5775	40° Up	7" (178mm)	5mm
RB5776	40° Up	7" (178mm)	6mm
RB5872	40° Up	8" (203mm)	2mm
RB5873	40° Up	8" (203mm)	3mm
RB5874	40° Up	8" (203mm)	4mm
RB5875	40° Up	8" (203mm)	5mm
RB5876	40° Up	8" (203mm)	6mm
RB5972	40° Up	9" (229mm)	2mm
RB5973	40° Up	9" (229mm)	3mm
RB5974	40° Up	9" (229mm)	4mm
RB5975	40° Up	9" (229mm)	5mm
RB5976	40° Up	9" (229mm)	6mm
RB5072	40° Up	10" (254mm)	2mm
RB5073	40° Up	10" (254mm)	3mm
RB5074	40° Up	10" (254mm)	4mm
RB5075	40° Up	10" (254mm)	5mm
RB5076	40° Up	10" (254mm)	6mm
RB5172	40° Up	11" (280mm)	2mm
RB5173	40° Up	11" (280mm)	3mm
RB5174	40° Up	11" (280mm)	4mm
RB5175	40° Up	11" (280mm)	5mm
RB5176	40° Up	11" (280mm)	6mm



RB5774

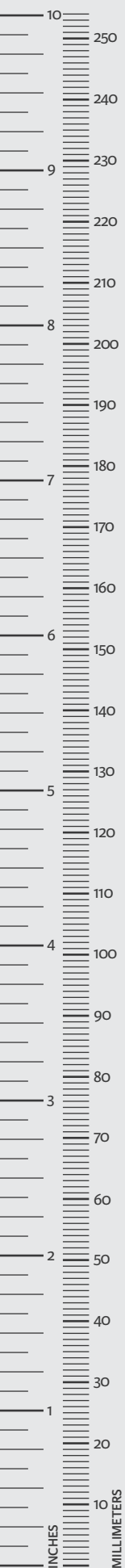

The Diamond™ Kerrison rongeurs have a black ceramic coating that increases the surface hardness vs. regular stainless steel, extending the life of the cutting edge and reduces intraoperative glare.

**Diamond Micro Kerrison Rongeurs, Detach**

small, improved handle, thin footplate  
9mm jaw opening

Cutting Angle	Bite Size	Catalog # 7" (178mm)	Catalog # 8" (203mm)	Catalog # 9" (229mm)	Catalog # 11" (279mm)
40° Up	1mm	RD4771DT	RD4891DT	RD4991DT	RD41191DT
40° Up	2mm	RD4752DT	RD4882DT	RD4982DT	RD41192DT
40° Up	3mm	RD4753DT	RD4853DT	RD4953DT	RD41193DT
40° Up	4mm	RD4754DT	RD4854DT	RD4954DT	RD41194DT
40° Up	5mm	RD4755DT	RD4855DT	RD4955DT	RD41195DT
40° Up	6mm	RD4756DT	RD4856DT	RD4956DT	RD41196DT



RD4752DT

**Diamond Micro Kerrison Rongeurs**

small, improved handle, thin footplate  
9mm jaw opening

Cutting Angle	Bite Size	Catalog # 7" (178mm)	Catalog # 8" (203mm)	Catalog # 11" (280mm)
40° Up	1mm	RD4771	RD4891	
40° Up	1.5mm	RD4751	RD4851	
40° Up	2mm	RD4752	RD4882	RD41192
40° Up	3mm	RD4753	RD4853	RD41193
40° Up	4mm	RD4754	RD4854	RD41194
40° Up	5mm	RD4755	RD4855	RD41195
40° Up	6mm	RD4756	RD4856	RD41196

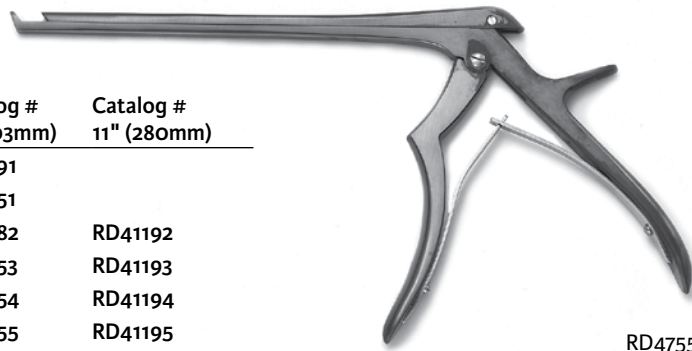

RD4755

**Diamond Medium Kerrison Rongeurs, Detach**

small, improved handle, thin footplate

15mm jaw opening

Catalog #	Cutting Angle	Length	Bite Size
RD4821DTM	40° Up	8" (200mm)	1mm
RD4822DTM	40° Up	8" (200mm)	2mm
RD4823DTM	40° Up	8" (200mm)	3mm
RD4824DTM	40° Up	8" (200mm)	4mm
RD4825DTM	40° Up	8" (200mm)	5mm
RD4826DTM	40° Up	8" (200mm)	6mm



**Diamond Medium Kerrison Rongeurs**

small, improved handle, thin footplate

15mm jaw opening

Catalog #	Cutting Angle	Length	Bite Size
RD4821M	40° Up	8" (200mm)	1mm
RD4851M	40° Up	8" (200mm)	1.5mm
RD4822M	40° Up	8" (200mm)	2mm
RD4823M	40° Up	8" (200mm)	3mm
RD4824M	40° Up	8" (200mm)	4mm
RD4825M	40° Up	8" (200mm)	5mm
RD4826M	40° Up	8" (200mm)	6mm



**Diamond Micro Kerrison Rongeurs, Bayonet**

small, improved handle, thin footplate  
9mm jaw opening

Catalog #	Cutting Angle	Working Length	Bite Size
RD5662	40° Up	7¾" (200mm)	2mm
RD5663	40° Up	7¾" (200mm)	3mm
RD5664	40° Up	7¾" (200mm)	4mm
RD5665	40° Up	7¾" (200mm)	5mm
RD5666	40° Up	7¾" (200mm)	6mm



RD5663

**Diamond Spurling Kerrison Rongeurs**

large, improved handle, thin footplate  
15mm jaw opening

Cutting Angle	Bite Size	Catalog # 7" (178mm)	Catalog # 8" (203mm)
40° Up	2mm	RD4722	RD4822
40° Up	3mm	RD4723	RD4823
40° Up	4mm	RD4724	RD4824
40° Up	5mm	RD4725	RD4825
40° Up	6mm	RD4726	RD4826



RD4823



The Stealth™ Kerrison rongeurs have a surface treatment intended to reduce friction between metal surfaces. The Stealth coating does not increase the hardness of the cutting edge, but reduces intraoperative glare.

### Stealth Micro Kerrison Rongeurs, Detach

small, improved handle, thin footplate  
9mm jaw opening

Catalog #	Cutting Angle	Bite Size	Length
RB4891DT	40° Up	1mm	8" (200mm)
RB4882DT	40° Up	2mm	8" (200mm)
RB4853DT	40° Up	3mm	8" (200mm)
RB4854DT	40° Up	4mm	8" (200mm)
RB4855DT	40° Up	5mm	8" (200mm)
RB4856DT	40° Up	6mm	8" (200mm)

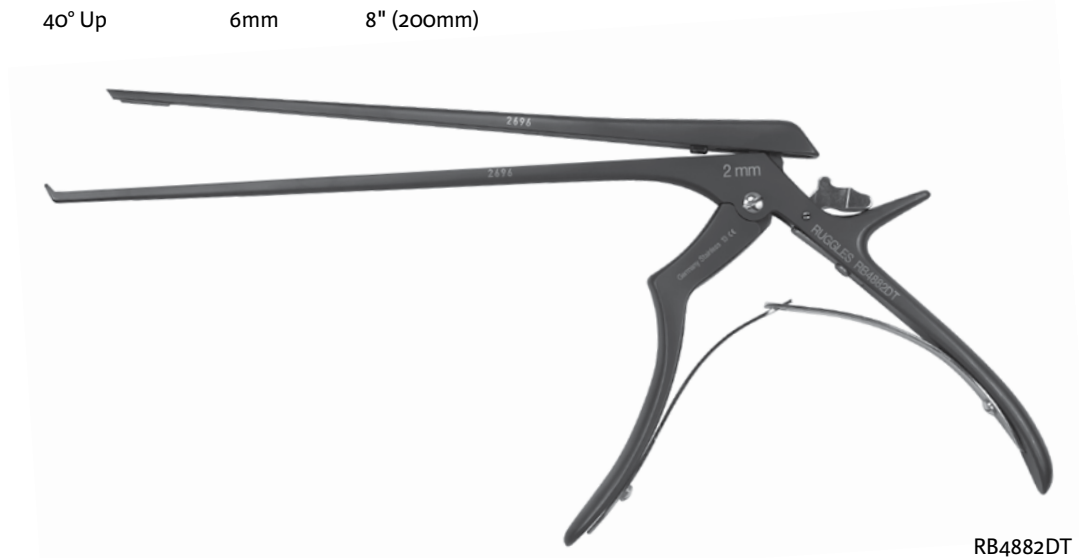

RB4882DT

### Stealth Micro Kerrison Rongeurs, Ejector

small, improved handle, thin footplate, pin ejector  
9mm jaw opening

Catalog #	Cutting Angle	Bite Size	Length
RB4892E	40° Up	2mm	8" (203mm)
RB4893	40° Up	3mm	8" (203mm)
RB4894	40° Up	4mm	8" (203mm)
RB4895	40° Up	5mm	8" (203mm)
RB4896	40° Up	6mm	8" (203mm)

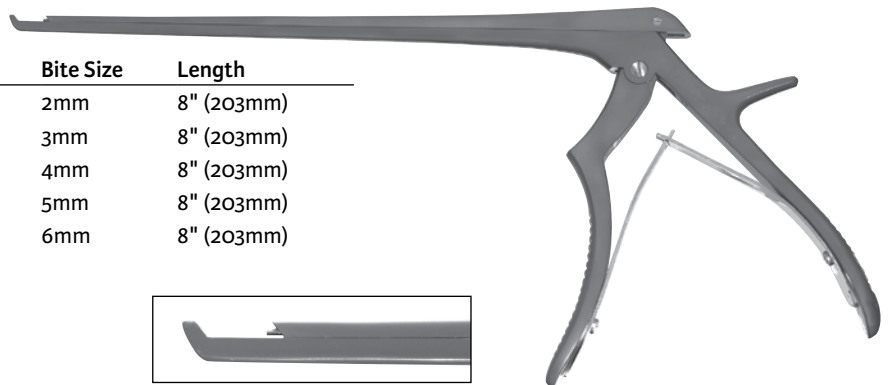

RB4892E

**Stealth Micro Kerrison Rongeurs**

small, improved handle, thin footplate  
9mm jaw opening

Cutting Angle	Bite Size	Catalog # 7" (178mm)	Catalog # 8" (203mm)	Catalog # 9" (229mm)	Catalog # 10" (254mm)	Catalog # 11" (279mm)
40° Up	1.5mm	RB4771	RB4891	RB4991	RB41091	RB41191
40° Up	2mm	RB4751	RB4851	RB4951	RB41051	RB41151
40° Up	3mm	RB4752	RB4882	RB4952	RB41052	RB41152
40° Up	4mm	RB4753	RB4853	RB4953	RB41053	RB41153
40° Up	5mm	RB4754	RB4854	RB4954	RB41054	RB41154
40° Up	6mm	RB4755	RB4855	RB4955	RB41055	RB41155
40° Up	1mm	RB4756	RB4856	RB4956	RB41056	RB41156
40° Down	2mm		RB4890			
40° Down	3mm		RB4892			
40° Down	4mm		RB4863			
40° Down	5mm		RB4864			
40° Down	6mm		RB4865			
40° Down	1mm		RB4866			
90° Up	2mm		RB4861			
90° Up	3mm		RB4862			
90° Up	4mm		RB4833			
90° Up	5mm		RB4834			
90° Up	6mm		RB4835			
90° Up	1mm		RB4836			
90° Down	2mm		RB4860			
90° Down	3mm		RB4872			
90° Down	4mm		RB4843			
90° Down	5mm		RB4844			
90° Down	6mm		RB4845			
90° Down			RB4846			

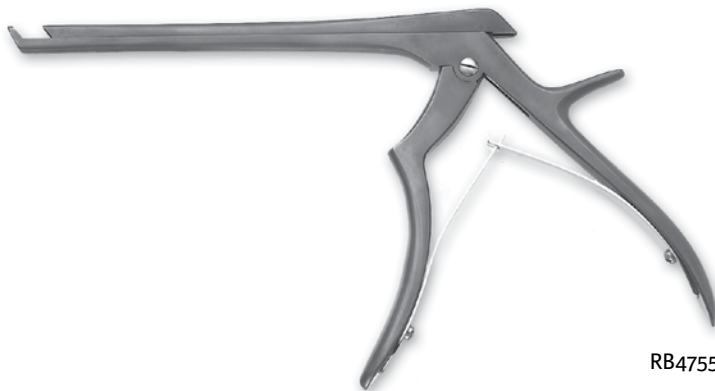

RB4755

**Stealth Medium Kerrison Rongeurs, Detach**

small, improved handle, thin footplate  
15mm jaw opening

Catalog #	Cutting Angle	Bite Size	Length
RB4821DTM	40° Up	1mm	8" (200mm)
RB4822DTM	40° Up	2mm	8" (200mm)
RB4823DTM	40° Up	3mm	8" (200mm)
RB4824DTM	40° Up	4mm	8" (200mm)
RB4825DTM	40° Up	5mm	8" (200mm)
RB4825DTM	40° Up	6mm	8" (200mm)

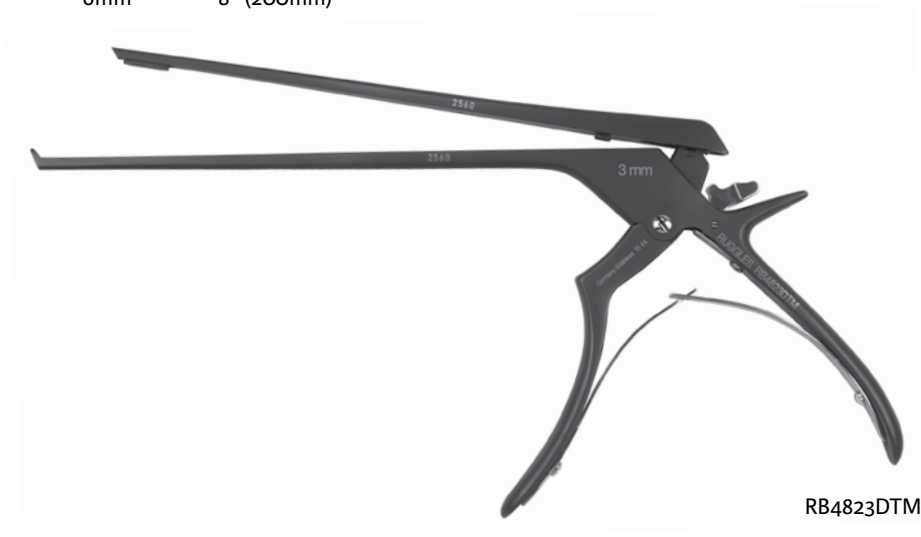

**Stealth Medium Kerrisons**

small, improved handle, thin footplate  
15mm jaw opening

Cutting Angle	Bite Size	Catalog # 7" (178mm)	Catalog # 8" (203mm)
40° Up	1mm	RB4721M	RB4821M
40° Up	1.5mm	RB4751M	RB4851M
40° Up	2mm	RB4722M	RB4822M
40° Up	3mm	RB4723M	RB4823M
40° Up	4mm	RB4724M	RB4824M
40° Up	5mm	RB4725M	RB4825M
40° Up	6mm	RB4726M	RB4826M



**Stealth Spurling Kerrison Rongeurs**

large, improved handle, thin footplate  
15mm jaw opening

Cutting Angle	Bite Size	Catalog # 7" (178mm)	Catalog # 8" (203mm)	Catalog # 9" (229mm)	Catalog # 10" (254mm)	Catalog # 11" (279mm)
40° Up	2mm	RB4722	RB4822	RB4922	RB41022	RB41122
40° Up	3mm	RB4723	RB4823	RB4923	RB41023	RB41123
40° Up	4mm	RB4724	RB4824	RB4924	RB41024	RB41124
40° Up	5mm	RB4725	RB4825	RB4925	RB41025	RB41125
40° Up	6mm	RB4726	RB4826	RB4926	RB41026	RB41126
90° Up	2mm		RB4802			
90° Up	3mm		RB4803			
90° Up	4mm		RB4804			
90° Up	5mm		RB4805			
90° Up	6mm		RB4806			
90° Down	2mm		RB4812			
90° Down	3mm		RB4813			
90° Down	4mm		RB4814			
90° Down	5mm		RB4815			
90° Down	6mm		RB4816			



RB4823

**Stealth Kerrison Rongeurs**

curved, hingeless

9mm jaw opening

Catalog #	Cutting Angle	Bite Size	Length
RB4872D	Curved Up	2mm	8" (203mm)
RB4873D	Curved Up	3mm	8" (203mm)
RB4874D	Curved Up	4mm	8" (203mm)
RB4875D	Curved Up	5mm	8" (203mm)

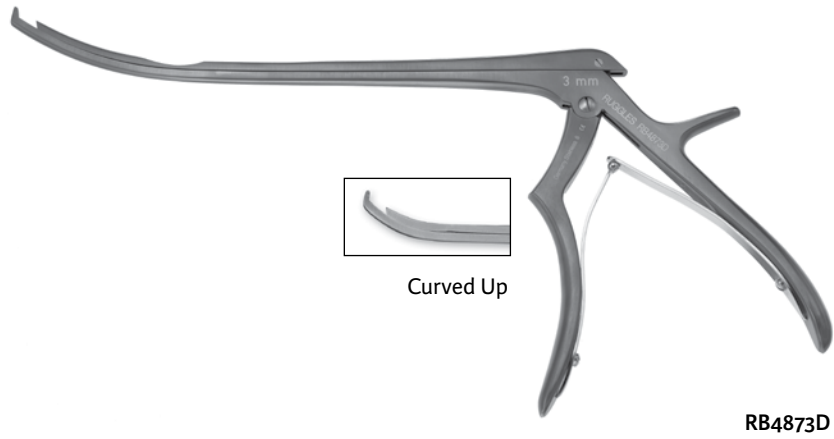

**Stealth Ferris-Smith Kerrison Rongeurs**

thin footplate

9mm jaw opening

Catalog #	Cutting Angle	Bite Size	Length
RB4719	40° Up	3mm	7" (178mm)
RB4720	40° Up	5mm	7" (178mm)



**Micro Kerrison Rongeurs**

small, improved handle, thin footplate  
9mm jaw opening

Cutting Angle	Bite Size	Catalog # 7" (178mm)	Catalog # 8" (203mm)	Catalog # 9" (229mm)	Catalog # 10" (254mm)	Catalog # 11" (279mm)
40° Up	1mm	RN4771	RN4891	RN4991	RN41091	RN41191
40° Up	1.5mm	RN4751	RN4851	RN4951	RN41051	RN41151
40° Up	2mm	RN4752	RN4882	RN4952	RN41052	RN41152
40° Up	3mm	RN4753	RN4853	RN4953	RN41053	RN41153
40° Up	4mm	RN4754	RN4854	RN4954	RN41054	RN41154
40° Up	5mm	RN4755	RN4855	RN4955	RN41055	RN41155
40° Up	6mm	RN4756	RN4856	RN4956	RN41056	RN41156
40° Down	1mm		RN4890			
40° Down	2mm		RN4892			
40° Down	3mm		RN4863			
40° Down	4mm		RN4864			
40° Down	5mm		RN4865			
40° Down	6mm		RN4866			
90° Up	1mm		RN4861			
90° Up	2mm		RN4862			
90° Up	3mm		RN4833			
90° Up	4mm		RN4834			
90° Up	5mm		RN4835			
90° Up	6mm		RN4836			
90° Down	1mm		RN4860			
90° Down	2mm		RN4872			
90° Down	3mm		RN4843			
90° Down	4mm		RN4844			
90° Down	5mm		RN4845			
90° Down	6mm		RN4846			



RN4752

**Micro Kerrison Rongeurs, Bar Ejector**

improved handle, thin footplate  
9mm jaw opening

Catalog #	Cutting Angle	Bite Size	Length
R1635	40° Up	2mm	8" (202mm)
R1636	40° Up	3mm	8" (202mm)
R1637	40° Up	4mm	8" (202mm)
R1638	40° Up	5mm	8" (202mm)

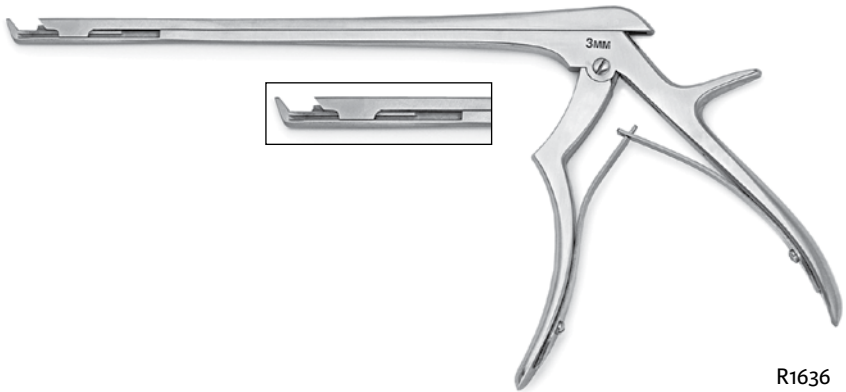

**Micro Kerrison Rongeurs, Pin Ejector**

small, improved handle, thin footplate  
9mm jaw opening

Catalog #	Cutting Angle	Bite Size	Length
RN4892E	40° Up	2mm	8" (203mm)
RN4893	40° Up	3mm	8" (203mm)
RN4894	40° Up	4mm	8" (203mm)
RN4895	40° Up	5mm	8" (203mm)
RN4896	40° Up	6mm	8" (203mm)

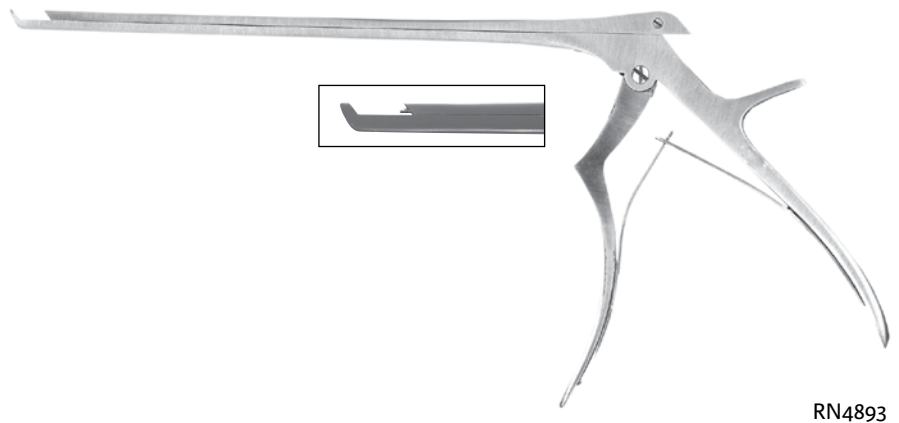

**Micro Kerrison Rongeurs, Curved, Hinged**

cherry handle, thin footplate  
9mm jaw opening

Catalog #	Cutting Angle	Bite Size	Length
R16702	Curved Up	2mm	8" (202mm)
R16703	Curved Up	3mm	8" (202mm)
R16704	Curved Up	4mm	8" (202mm)
R16705	Curved Up	5mm	8" (202mm)
R16706	Curved Up	6mm	8" (202mm)
R16703L	Curved Left	3mm	8" (202mm)
R16703R	Curved Right	3mm	8" (202mm)

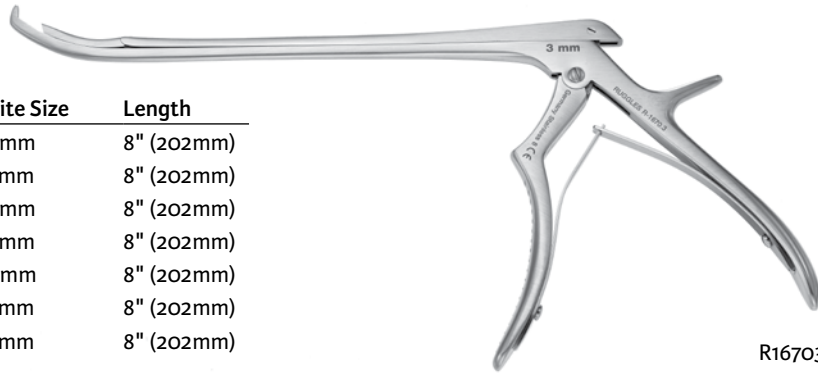

R16703



40° Curved Up



90° Curved Left



90° Curved Right

**Micro Kerrison Rongeurs, Curved, Hingeless**

cherry handle, thin footplate  
9mm jaw opening

Catalog #	Cutting Angle	Bite Size	Length
RN4872D	Curved Up	2mm	8" (202mm)
RN4873D	Curved Up	3mm	8" (202mm)
RN4874D	Curved Up	4mm	8" (202mm)
RN4875D	Curved Up	5mm	8" (202mm)



RN4872D



Curved Up



**Spurling Kerrison Rongeurs**

large, improved handle, thin footplate  
15mm jaw opening

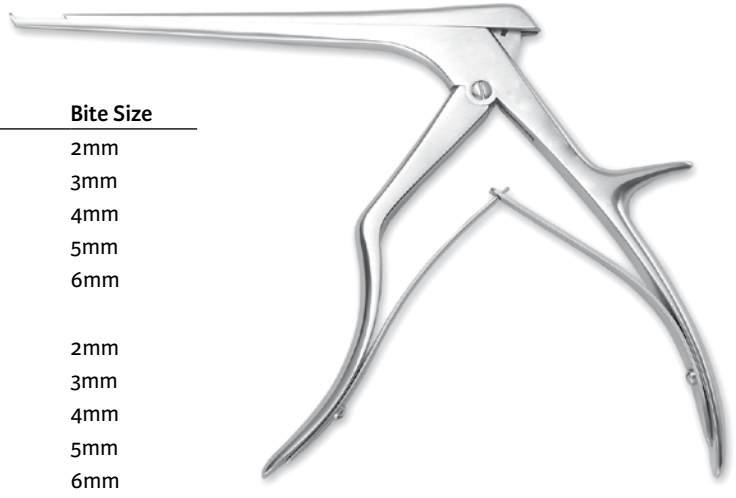

RN4722

Catalog #	Cutting Angle	Length	Bite Size
RN4722	40° Up	7" (178mm)	2mm
RN4723	40° Up	7" (178mm)	3mm
RN4724	40° Up	7" (178mm)	4mm
RN4725	40° Up	7" (178mm)	5mm
RN4726	40° Up	7" (178mm)	6mm
RN4822	40° Up	8" (203mm)	2mm
RN4823	40° Up	8" (203mm)	3mm
RN4824	40° Up	8" (203mm)	4mm
RN4825	40° Up	8" (203mm)	5mm
RN4826	40° Up	8" (203mm)	6mm
RN4802	90° Up	8" (203mm)	2mm
RN4803	90° Up	8" (203mm)	3mm
RN4804	90° Up	8" (203mm)	4mm
RN4805	90° Up	8" (203mm)	5mm
RN4806	90° Up	8" (203mm)	6mm
RN4812	90° Down	8" (203mm)	2mm
RN4813	90° Down	8" (203mm)	3mm
RN4814	90° Down	8" (203mm)	4mm
RN4815	90° Down	8" (203mm)	5mm
RN4816	90° Down	8" (203mm)	6mm
RN4922	40° Up	9" (229mm)	2mm
RN4923	40° Up	9" (229mm)	3mm
RN4924	40° Up	9" (229mm)	4mm
RN4925	40° Up	9" (229mm)	5mm
RN4926	40° Up	9" (229mm)	6mm
RN41022	40° Up	10" (254mm)	2mm
RN41023	40° Up	10" (254mm)	3mm
RN41024	40° Up	10" (254mm)	4mm
RN41025	40° Up	10" (254mm)	5mm
RN41026	40° Up	10" (254mm)	6mm
RN41122	40° Up	11" (279mm)	2mm
RN41123	40° Up	11" (279mm)	3mm
RN41124	40° Up	11" (279mm)	4mm
RN41125	40° Up	11" (279mm)	5mm
RN41126	40° Up	11" (279mm)	6mm



**Spurling Kerrison Rongeurs**

cherry handle, thin footplate  
15mm jaw opening

Catalog #	Cutting Angle	Bite Size	Length
RN4722X	40° Up	2mm	7" (178mm)
RN4723X	40° Up	3mm	7" (178mm)
RN4724X	40° Up	4mm	7" (178mm)
RN4725X	40° Up	5mm	7" (178mm)
RN4726X	40° Up	6mm	7" (178mm)
RN4822X	40° Up	2mm	8" (203mm)
RN4823X	40° Up	3mm	8" (203mm)
RN4824X	40° Up	4mm	8" (203mm)
RN4825X	40° Up	5mm	8" (203mm)
RN4826X	40° Up	6mm	8" (203mm)

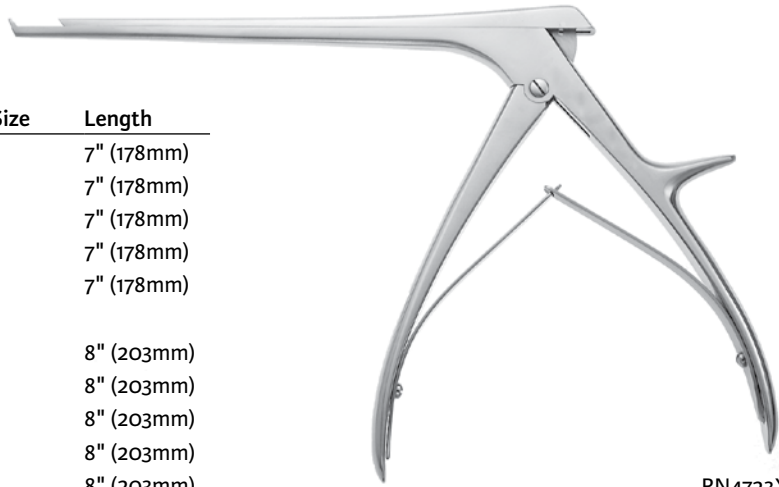

RN4723X

**Spurling Kerrison Rongeurs, Bar Ejector**

improved handle, thin footplate  
15mm jaw opening

Catalog #	Cutting Angle	Bite Size	Length
R16403	40° Up	3mm	8" (202mm)
R16404	40° Up	4mm	8" (202mm)
R16405	40° Up	5mm	8" (202mm)

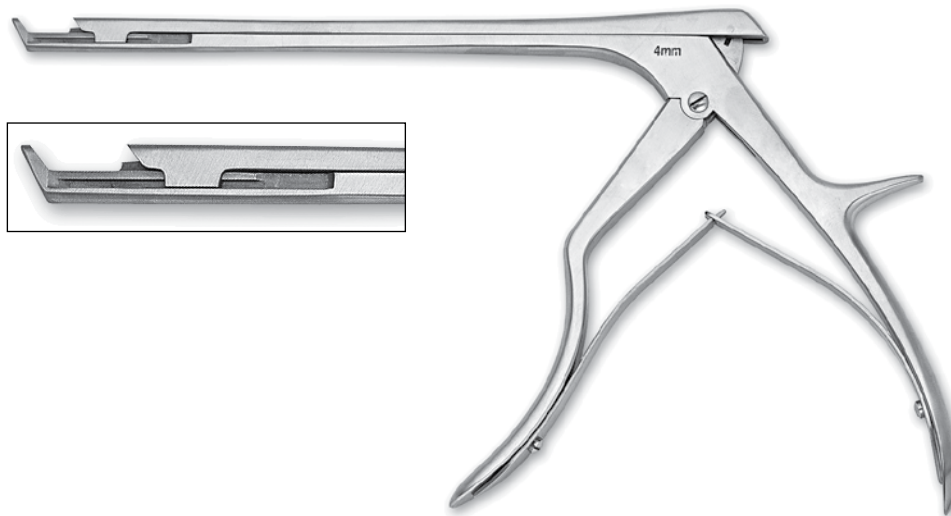

R16404

**Open-Handle Kerrison Rongeurs**

thin footplate  
9mm jaw opening

Catalog #	Cutting Angle	Bite Size	Length
R1587	40° Up	2mm	7" (178mm)
R1591	40° Up	3mm	7" (178mm)
R1593	40° Up	4mm	7" (178mm)
R1596	40° Up	5mm	7" (178mm)



R1593

**Medium Kerrison Rongeurs**

small, improved handle, thin footplate  
15mm jaw opening

Catalog #	Cutting Angle	Bite Size	Length
RN4721M	40° Up	1mm	7" (178mm)
RN4751M	40° Up	1.5mm	7" (178mm)
RN4722M	40° Up	2mm	7" (178mm)
RN4723M	40° Up	3mm	7" (178mm)
RN4724M	40° Up	4mm	7" (178mm)
RN4725M	40° Up	5mm	7" (178mm)
RN4726M	40° Up	6mm	7" (178mm)
RN4821M	40° Up	1mm	8" (203mm)
RN4851M	40° Up	1.5mm	8" (203mm)
RN4822M	40° Up	2mm	8" (203mm)
RN4823M	40° Up	3mm	8" (203mm)
RN4824M	40° Up	4mm	8" (203mm)
RN4825M	40° Up	5mm	8" (203mm)
RN4826M	40° Up	6mm	8" (203mm)



RN4822M

**Ferris-Smith Kerrison Rongeurs**

thin footplate

Catalog #	Cutting Angle	Bite Size	Length
RN4737	40° Up	2mm	7" (178mm)
RN4719	40° Up	3mm	7" (178mm)
RN4739	40° Up	4mm	7" (178mm)
RN4720	40° Up	5mm	7" (178mm)
RB3892	40° Up	2mm	8" (203mm)
RN4819	40° Up	3mm	8" (203mm)
RB3894	40° Up	4mm	8" (203mm)
RB3895	40° Up	5mm	8" (203mm)



RN4720

### Kerrison Instrument Tray

<u>Catalog #</u>	<u>Description</u>
RBT1001	Holds 8 Kerrisons



**Integra<sup>®</sup>**  
Curettes

Curette Cup Size (mm), 5-0 thru #6

Size:	5-0	4-0	3-0	2-0	1-0	#1	#2	#3	#4	#5	#6
W x L	1.7 x 2.7	2.1 x 3	2.5 x 3.8	2.9 x 4.5	3.5 x 5.5	4.3 x 7.1	5.1 x 8.1	5.6 x 9	7.6 x 10.8	9 x 13	10 x 15

Ultra-Coat™ Spinal Curettes have an extremely hard material coating that increases the surface hardness vs. regular stainless steel IVD rongeurs, extending the life of the cutting edge.

**Ultra-Coat Spinal Curettes**

straight



Catalog #	Catalog #	Catalog #	Catalog #	Description	Cup Size	
6 3/4" (171mm)	8" (203mm)	9" (229mm)	12" (305mm)			RB7714
RB7701	RB7712	RB7723	RB7734	Straight	5-0	
RB7702	RB7713	RB7724	RB7735	Straight	4-0	
RB7703	RB7714	RB7725	RB7736	Straight	3-0	
RB7704	RB7715	RB7726	RB7737	Straight	2-0	
RB7705	RB7716	RB7727	RB7738	Straight	1-0	
RB7706	RB7717	RB7728	RB7739	Straight	#1	
RB7707	RB7718	RB7729	RB7740	Straight	#2	
RB7708	RB7719	RB7730	RB7741	Straight	#3	
RB7709	RB7720	RB7731	RB7742	Straight	#4	
RB7710	RB7721	RB7732	RB7743	Straight	#5	
RB7711	RB7722	RB7733	RB7744	Straight	#6	

Straight

**Ultra-Coat Spinal Curettes**

reverse angle

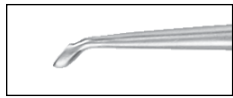

Catalog #	Catalog #	Catalog #	Description	Cup Size	
8" (203mm)	9" (229mm)	12" (305mm)			RB7803
RB7801	RB7812	RB7823	Reverse Angled	5-0	
RB7802	RB7813	RB7824	Reverse Angled	4-0	
RB7803	RB7814	RB7825	Reverse Angled	3-0	
RB7804	RB7815	RB7826	Reverse Angled	2-0	
RB7805	RB7816	RB7827	Reverse Angled	1-0	
RB7806	RB7817	RB7828	Reverse Angled	#1	
RB7807	RB7818	RB7829	Reverse Angled	#2	
RB7808	RB7819	RB7830	Reverse Angled	#3	
RB7809	RB7820	RB7831	Reverse Angled	#4	
RB7810	RB7821	RB7832	Reverse Angled	#5	
RB7811	RB7822	RB7833	Reverse Angled	#6	

Reverse-Angled

Curette Cup Size (mm), 5-0 thru #6

Size:	5-0	4-0	3-0	2-0	1-0	#1	#2	#3	#4	#5	#6
W x L	1.7 x 2.7	2.1 x 3	2.5 x 3.8	2.9 x 4.5	3.5 x 5.5	4.3 x 7.1	5.1 x 8.1	5.6 x 9	7.6 x 10.8	9 x 13	10 x 15

**Ultra-Coat Spinal Curettes**

angled



Catalog # 8" (203mm)	Catalog # 9" (229mm)	Catalog # 12" (305mm)	Description	Cup Size	
RB7745	RB7756	RB7767	Angled	5-0	RB7748
RB7746	RB7757	RB7768	Angled	4-0	
RB7747	RB7758	RB7769	Angled	3-0	
RB7748	RB7759	RB7770	Angled	2-0	
RB7749	RB7760	RB7771	Angled	1-0	
RB7750	RB7761	RB7772	Angled	#1	
RB7751	RB7762	RB7773	Angled	#2	
RB7752	RB7763	RB7774	Angled	#3	
RB7753	RB7764	RB7775	Angled	#4	
RB7754	RB7765	RB7776	Angled	#5	
RB7755	RB7766	RB7777	Angled	#6	

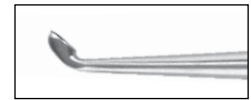

Angled

**Ultra-Coat Flatback Curettes**

standard cup, hollow handles

Catalog # 9" (230mm) Angled 90°	Catalog # 9" (230mm) Straight	Catalog # 9" (230mm) Angled	Catalog # 9" (230mm) Reverse Angle	Cup Size	
RB7940	RB7900	RB7920	RB7960	6-0	
RB7941	RB7901	RB7921	RB7961	5-0	
RB7942	RB7902	RB7922	RB7962	4-0	
RB7943	RB7903	RB7923	RB7963	3-0	
RB7944	RB7904	RB7924	RB7964	2-0	
RB7945	RB7905	RB7925	RB7965	1-0	
RB7946	RB7906	RB7926	RB7966	#1	
RB7947	RB7907	RB7927	RB7967	#2	
RB7948	RB7908	RB7928	RB7968	#3	
RB7949	RB7909	RB7929	RB7969	#4	
RB7950	RB7910	RB7930	RB7970	#5	
RB7951	RB7911	RB7931	RB7971	#6	

Flatback Curette

Regular Curette



Curette Cup Size (mm), 5-0 thru #6

Size:	5-0	4-0	3-0	2-0	1-0	#1	#2	#3	#4	#5	#6
W x L	1.7 x 2.7	2.1 x 3	2.5 x 3.8	2.9 x 4.5	3.5 x 5.5	4.3 x 7.1	5.1 x 8.1	5.6 x 9	7.6 x 10.8	9 x 13	10 x 15

**Spinal Fusion Curettes**

standard cup, hollow handles  
straight



Catalog # 6 3/4" (171mm)	Catalog # 8" (203mm)	Catalog # 9" (229mm)	Catalog # 12" (305mm)	Description	Cup Size	RNo601
RNo6001	REo800	RNo900	RNo1200	Straight	5-0	
RNo600	REo801	RNo901	RNo1201	Straight	4-0	
RNo601	REo802	RNo902	RNo1202	Straight	3-0	
RNo602	REo803	RNo903	RNo1203	Straight	2-0	
RNo603	REo804	RNo904	RNo1204	Straight	1-0	
RNo604	REo805	RNo905	RNo1205	Straight	#1	
RNo605	REo806	RNo906	RNo1206	Straight	#2	
RNo606	REo807	RNo907	RNo1207	Straight	#3	
RNo607	REo808	RNo908	RNo1208	Straight	#4	
RNo608	REo809	RNo909	RNo1209	Straight	#5	
RNo609	REo810	RNo910	RNo1210	Straight	#6	

**Spinal Fusion Curettes**

standard cup, hollow handles  
straight



Catalog # 6 3/4" (171mm)	Catalog # 8" (203mm)	Catalog # 9" (229mm)	Catalog # 12" (305mm)	Description	Cup Size	RNo923
-	REo820	RNo920	RNo1220	Angled	5-0	
-	REo821	RNo921	RNo1221	Angled	4-0	
Ro360B	REo822	RNo922	RNo1222	Angled	3-0	
Ro361B	REo823	RNo923	RNo1223	Angled	2-0	
Ro362B	REo824	RNo924	RNo1224	Angled	1-0	
Ro363B	REo825	RNo925	RNo1225	Angled	#1	
Ro364B	REo826	RNo926	RNo1226	Angled	#2	
Ro365B	REo827	RNo927	RNo1227	Angled	#3	
Ro366B	REo828	RNo928	RNo1228	Angled	#4	
Ro367B	REo829	RNo929	RNo1229	Angled	#5	
Ro368B	REo830	RNo930	RNo1230	Angled	#6	

Curette Cup Size (mm), 5-0 thru #6

Size:	5-0	4-0	3-0	2-0	1-0	#1	#2	#3	#4	#5	#6
W x L	1.7 x 2.7	2.1 x 3	2.5 x 3.8	2.9 x 4.5	3.5 x 5.5	4.3 x 7.1	5.1 x 8.1	5.6 x 9	7.6 x 10.8	9 x 13	10 x 15
	0	0	0	0	0	0	0	0	0	0	0

**Spinal Fusion Curettes**

standard cup, hollow handles  
straight



Catalog # 8" (203mm)	Catalog # 9" (229mm)	Catalog # 12" (305mm)	Description	Cup Size	RN0954
RE0848	RN0948	RN01248	Reverse Angled	5-0	
RE0849	RN0949	RN01249	Reverse Angled	4-0	
RE0850	RN0950	RN01250	Reverse Angled	3-0	
RE0851	RN0951	RN01251	Reverse Angled	2-0	
RE0852	RN0952	RN01252	Reverse Angled	1-0	
RE0853	RN0953	RN01253	Reverse Angled	#1	
RE0854	RN0954	RN01254	Reverse Angled	#2	
RE0855	RN0955	RN01255	Reverse Angled	#3	
RE0856	RN0956	RN01256	Reverse Angled	#4	
RE0857	RN0957	RN01257	Reverse Angled	#5	
RE0858	RN0958	RN01258	Reverse Angled	#6	

**Spinal Fusion Curette Tray**

Catalog #	Description
R8113	Single Level, Holds 10-9" Curettes
R8114	Double Level, Holds 20-9" Curettes
RS0900	Single Level, Holds 12-8" or 9" Curettes
RSBT1002	Single Level, Holds 12-8" or 9" Curettes



R8114



RS0900

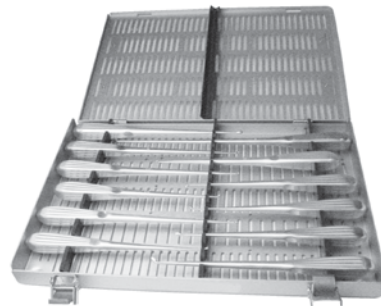

RBT1002

Curette Cup Size (mm), 6-0 thru #6

Size:	6-0	5-0	4-0	3-0	2-0	1-0	#1	#2	#3	#4	#5	#6
W x L	1.3 x 2.2	1.7 x 2.7	2.1 x 3	2.5 x 3.8	2.9 x 4.5	3.5 x 5.5	4.3 x 7.1	5.1 x 8.1	5.6 x 9	7.6 x 10.8	9 x 13	10 x 15
	0	0	0	0	0	0	0	0	0	0	0	0

The design of the Ruggles Flatback Curettes has eliminated the bulk at the back of the curette thus allowing the curette to become more maneuverable for removing of the disc material.

**Flatback Spinal Fusion Curettes**

standard cup, hollow handles

Catalog # 8 3/4" (224mm) Angled 90°	Catalog # 9" (230mm) Straight	Catalog # 9" (230mm) Angled 40°	Catalog # 9" (230mm) Reverse-Angle	Cup Size
R2839	R2799	R2819	RB7170	6-0
R2840	R2800	R2820	R2850	5-0
R2841	R2801	R2821	R2851	4-0
R2842	R2802	R2822	R2852	3-0
R2843	R2803	R2823	R2853	2-0
R2844	R2804	R2824	R2854	1-0
R2845	R2805	R2825	R2855	#1
R2846	R2806	R2826	R2856	#2
R2847	R2807	R2827	R2857	#3
R2848	R2808	R2828	R2858	#4
R2849	R2809	R2829	R2859	#5
RB7281	R2810	R2830	RB7181	#6



R2805



R2825



### Spinal Fusion Curettes

standard cup, hollow handles  
 12" (305mm)

Catalog # Straight	Catalog # Angled	Cup Size	Cup Size
R2000	R2010	3-0	3.3 x 4.9mm
R2001	R2011	2-0	4.2 x 5.6mm
R2002	R2012	1-0	4.6 x 6.6mm
R2003	R2013	#1	5.2 x 7.6mm
R2004	R2014	#2	6.2 x 9.7mm
R2005	R2015	#3	7.2 x 11.1mm
R2006	R2016	#4	8.4 x 13mm
R2007	R2017	#5	9.5 x 14.6mm
R2008	R2018	#6	10.6 x 16.8mm



R2008



R2018

### Spinal Fusion Curette Tray

Catalog #	Description
R6523	Single Level Holds 14-12" Curettes

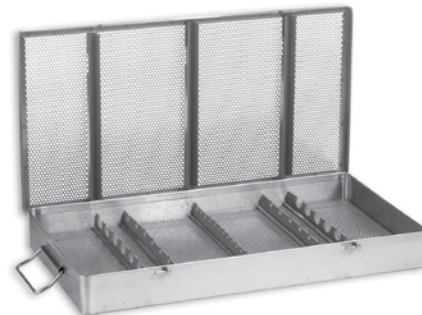

### Scoville Ruptured Disc Curettes

standard cup, hollow handles  
 10" (254mm)

Catalog #	Description	Cup Size
RNo960	Straight	4.2 x 10mm
RNo961	Lateral	4.2 x 10mm
RNo962	Angled	4.2 x 10mm



RNo962

**Thoraco-Lumbar Curettes**

resin handles  
13½" (340mm)

Catalog # Straight	Catalog # Angled	Catalog # Reverse Angled	Cup Size	Cup Size
R6513	R6517	R6521	2-0	3 x 4.6mm
R6512	R6516	R6520	1-0	3.3 x 5mm
R6511	R6515	R6519	#1	4.1 x 6.9mm
R6510	R6514	R6518	#2	5 x 7.5mm



Angled



Reverse-Angle



R6513

**Thoraco-Lumbar Dissectors**

angled, 13½" (340mm)

Catalog #	Description
R6506	Large
R6507	Small



Dissector-Angle

**Apfelbaum Extended Reach Curettes**

aluminum handles  
angled

Catalog # 12" (305mm)	Catalog # 14½" (368mm)	Cup Size	Cup Size	Reach	Handle Color
RN1171	RN1181	4-0	2 x 3mm	5mm	Red
RN1172	RN1182	4-0	2 x 3mm	6mm	Blue
RN1173	RN1183	4-0	2 x 3mm	7mm	Gold



RN1171

### Cobb Style Bone Curettes

solid, knurled handle

11" (279mm)

Catalog # Straight	Catalog # Angled	Cup Size	Cup Size
R2220	R2230	3-0	2 x 3.5mm
R2221	R2231	2-0	2.5 x 4.4mm
R2222	R2232	1-0	3 x 5mm
R2223	R2233	#1	3.5 x 6.2mm
R2224	R2234	#2	4.5 x 7.6mm
R2225	R2235	#3	5.5 x 9mm
R2226	R2236	#4	7.5 x 11.7mm
R2227	R2237	#5	8.5 x 12.7mm
R2228	R2238	#6	10 x 15.2mm

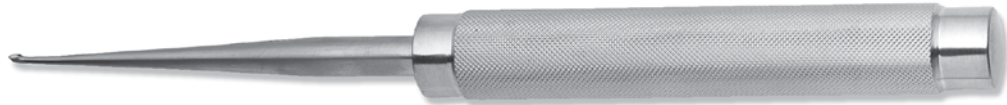

R2220



R2234

### Epstein Curettes

standard, hollow handle, reverse angle

8" (203mm)

Catalog # Straight	Catalog # Angled	Cup Size	Cup Size
RNo820	R2230	3-0	2.6 x 3.9mm
RNo821	R2231	2-0	2.6 x 4.5mm
RNo822	R2232	1-0	3.3 x 5.5mm



RNo820

Curette Cup Size (mm), 5-0 thru 3-0

Size:	5-0	4-0	3-0
W x L	1.7 x 2.7	2.1 x 3	2.5 x 3.8
	○	○	○

**Micro Angled Curettes**

standard, hollow handle

9" (229mm)

Catalog # Straight	Catalog # Angled	Cup Size	Cup Size
RNo981	RNo986	5-0	1.7 x 2.7mm
RNo982	RNo987	4-0	2.1 x 3mm
RNo983	RNo988	3-0	2.5 x 3.8mm



RNo986

**Micro Angled Curettes**

standard, hollow handle

9" (229mm)

Catalog # Straight	Catalog # Angled	Catalog # Reverse-Angled	Cup Size	Cup Size
RNo881	RNo886	RNo897	5-0	1.7 x 2.7mm
RNo882	RNo887	RNo898	4-0	2.1 x 3mm
RNo883	RNo888	RNo899	3-0	2.5 x 3.8mm



RNo883



### Round Handle Bayonet Micro Curettes

9 1/2" (240mm)

Catalog #	Description	Cup Size
R7350	Straight	3mm
R7351	45° Angle	3mm
R7352	90° Angle	3mm
R7353	Curved Up	3mm



R7350

### Round Handle Bayonet Micro Curettes

9 1/2" (240mm)

Catalog #	Description	Tip Length	Cup Size
R7360	45° Up	5mm	3mm
R7361	45° Down	5mm	3mm
R7362	45° Right	5mm	3mm
R7363	45° Left	5mm	3mm
R7370	45° Up	10mm	3mm
R7371	45° Down	10mm	3mm
R7372	45° Right	10mm	3mm
R7373	45° Left	10mm	3mm



R7360



R7370

### Round Handle Bayonet Micro Curettes

9 1/2" (240mm)

Catalog #	Description	Tip Length	Cup Size
R7365	90° Up	5mm	3mm
R7366	90° Down	5mm	3mm
R7367	90° Right	5mm	3mm
R7368	90° Left	5mm	3mm



R7366



**Cone Ring Curettes**

solid, knurled aluminum handle  
9" (229mm)

Catalog #	Description	Ring Size
RNo991	Straight	8mm
RNo992	Straight	6mm
RNo993	Straight	3mm
RNo994	Angled	8mm
RNo995	Angled	6mm
RNo996	Angled	3mm



RNo992



RNo994



Curette Cup Size (mm), 6-0 thru 0

Size:	6-0	5-0	4-0	3-0	2-0	1-0
W x L	1.3 x 2.2	1.7 x 2.7	2.1 x 3	2.5 x 3.8	2.9 x 4.5	3.5 x 5.5
	0	0	0	0	0	0

**Sisco Bayonet Curettes**

standard cup, hollow handles  
9" (229mm), working length 1¾" (44mm)

Catalog # Straight	Catalog # 40° Angle	Catalog # 90° Angle	Catalog # Reverse-Angle Up	Catalog # Reverse-Angle Down	Cup Size
R2871	R2891	R2870	R2865	R2881	6-0
R2872	R2892	R2860	R2866	R2882	5-0
R2873	R2893	R2861	R2867	R2883	4-0
R2874	R2894	R2862	R2868	R2884	3-0
R2875	R2895	R2863	R2877	R2885	2-0
R2876	R2896	R2864	R2878	R2886	1-0



R2872



40° Angle



90° Angle



Reverse-Angle Up



Reverse-Angle Down

**Spinal Fusion Curette Tray**

Catalog #	Description
R8113	Single Level Holds 9-9" Bayonet Curettes
R8114	Double Level Holds 18-9" Bayonet Curettes



R8113

**Cervical Bayonet Curettes**

8 1/2" (213mm)

Catalog # \_\_\_\_\_

RR8100



Set includes one each of RR8110 through RR8133 plus two (2) each of RS0900 Trays

Catalog #	Description	Cup	Angle
RR8110	Curette	1-0	Forward-Straight
RR8111	Curette	2-0	Forward-Straight
RR8112	Curette	3-0	Forward-Straight
RR8113	Curette	4-0	Forward-Straight
RR8114	Bone Cutter	2-0	Forward-Straight
RR8115	Curette	1-0	Forward-Angle
RR8116	Curette	2-0	Forward-Angle
RR8117	Curette	3-0	Forward-Angle
RR8118	Curette	4-0	Forward-Angle
RR8119	Bone Cutter	2-0	Forward-Angle
RR8120	Curette	1-0	Backward-Straight
RR8121	Curette	2-0	Backward-Straight
RR8122	Curette	3-0	Backward-Straight
RR8123	Curette	4-0	Backward-Straight
RR8124	Bone Cutter	2-0	Backward-Straight
RR8125	Curette	1-0	Backward-Angle
RR8126	Curette	2-0	Backward-Angle
RR8127	Curette	3-0	Backward-Angle
RR8128	Curette	4-0	Backward-Angle
RR8129	Bone Cutter	2-0	Backward-Angle

Catalog #	Description	Length
RR8130	Nerve Hook	8 3/4" (222mm)
RR8131	Ultra Nerve Hook-Up	8 3/4" (222mm)
RR8132	Bone Waxer-Up	8 3/4" (222mm)
RR8133	Knife Handle (Holds Codman Blades)	5 7/8" (149mm)

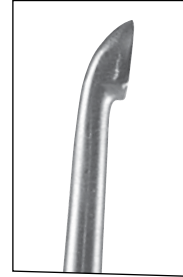

FORWARD STRAIGHT



FORWARD ANGLE



BACKWARD STRAIGHT



BACKWARD ANGLE



CORTICAL BONE CUTTING



NERVE HOOK



BONE WAXER



**Cervical Bayonet Curettes, XL**

9 1/2" (241mm)

Catalog # \_\_\_\_\_

RR8200



Set includes one each of RR8010 through RR8232 and RR8133 plus two (2) each of RS0900 Trays

Catalog #	Description	Cup	Angle
RR8210	Curette	1-0	Forward-Straight
RR8211	Curette	2-0	Forward-Straight
RR8212	Curette	3-0	Forward-Straight
RR8213	Curette	4-0	Forward-Straight
RR8214	Bone Cutter	2-0	Forward-Straight
RR8215	Curette	1-0	Forward-Angle
RR8216	Curette	2-0	Forward-Angle
RR8217	Curette	3-0	Forward-Angle
RR8218	Curette	4-0	Forward-Angle
RR8219	Bone Cutter	2-0	Forward-Angle
RR8220	Curette	1-0	Backward-Straight
RR8221	Curette	2-0	Backward-Straight
RR8222	Curette	3-0	Backward-Straight
RR8223	Curette	4-0	Backward-Straight
RR8224	Bone Cutter	2-0	Backward-Straight
RR8225	Curette	1-0	Backward-Angle
RR8226	Curette	2-0	Backward-Angle
RR8227	Curette	3-0	Backward-Angle
RR8228	Curette	4-0	Backward-Angle
RR8229	Bone Cutter	2-0	Backward-Angle

Catalog #	Description	Length
RR8230	Nerve Hook	8 3/4" (222mm)
RR8231	Ultra Nerve Hook-Up	8 3/4" (222mm)
RR8232	Bone Waxer-Up	8 3/4" (222mm)
RR8133	Knife Handle (Holds Codman Blades)	5 7/8" (149mm)



FORWARD STRAIGHT



FORWARD ANGLE



BACKWARD STRAIGHT



BACKWARD ANGLE



CORTICAL BONE CUTTING



NERVE HOOK



BONE WAXER

### Lumbar Bayonet Curettes

Catalog # \_\_\_\_\_  
RR8000



Set includes one each of RR8810 through RR8033 plus two (2) each of RS0900 Trays

### Cervical Bayonet Curettes

Description	Cup Size	Catalog # 9 1/2" (240mm)	Catalog # 11" (279mm)	Angle
Curette	#0	RR8010	RR801011	Forward-Straight
Curette	#1	RR8011	RR801111	Forward-Straight
Curette	#2	RR8012	RR801211	Forward-Straight
Curette	#0	RR8013	RR801311	Forward-Angle
Curette	#1	RR8014	RR801411	Forward-Angle
Curette	#2	RR8015	RR801511	Forward-Angle
Curette	#0	RR8016	RR801611	Forward-Down
Curette	#1	RR8017	RR801711	Forward-Down
Curette	#2	RR8018	RR801811	Forward-Down
Curette	#0	RR8019	RR801911	Backward-Straight
Curette	#1	RR8020	RR802011	Backward-Straight
Curette	#2	RR8021	RR802111	Backward-Straight
Curette	#0	RR8022	RR802211	Backward-Angle
Curette	#1	RR8023	RR802311	Backward-Angle
Curette	#2	RR8024	RR802411	Backward-Angle
Curette	#0	RR8025	RR802511	Backward-Down
Curette	#1	RR8026	RR802611	Backward-Down
Curette	#2	RR8027	RR802711	Backward-Down
Penfield Dissector	#1	RR8028	RR802811	
Penfield Dissector	#2	RR8029	RR802911	
Nerve Hook		RR8030	RR803011	
Penfield Dissector	#4	RR8031	RR803111	
Bone Waxer		RR8032	RR803211	
Spine Probe		RR8033	RR803311	



FORWARD STRAIGHT



FORWARD ANGLE



BACKWARD STRAIGHT



BACKWARD ANGLE

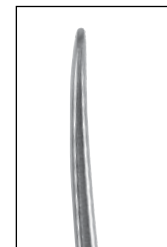

PENFIELD DISSECTOR



NERVE HOOK

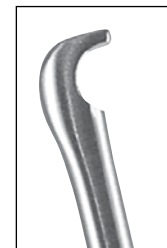

BONE WAXER

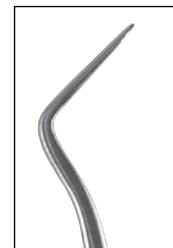

SPINE PROBE



**Integra**<sup>®</sup>  
Suction Tubes

	○	○	○	○	○	○	○	○	○	○
French	3 Fr.	4 Fr.	5 Fr.	6 Fr.	7 Fr.	8 Fr.	9 Fr.	10 Fr.	11 Fr.	12 Fr.
Inches	.039	.053	.066	.079	.092	.105	.118	.131	.144	.158
Millimeters	1	1.4	1.7	2.0	2.3	2.7	3.0	3.3	3.7	4.0

**Frazier Suction Tubes**

semi-rigid with hole

straight, overall length 7¾" (195mm)

Catalog #	Working Length	Fr. Size
RN8563	5½" (140mm)	3 Fr.
RN8564	5½" (140mm)	4 Fr.
RN8565	5½" (140mm)	5 Fr.
RN8566	5½" (140mm)	6 Fr.
RN8567	5½" (140mm)	7 Fr.
RN8568	5½" (140mm)	8 Fr.
RN8569	5½" (140mm)	9 Fr.
RN85610	5½" (140mm)	10 Fr.
RN85611	5½" (140mm)	11 Fr.
RN85612	5½" (140mm)	12 Fr.

angled, overall length 7" (178mm)

Catalog #	Working Length	Fr. Size
RN8583	4¼" (108mm)	3 Fr.
RN8584	4¼" (108mm)	4 Fr.
RN8585	4¼" (108mm)	5 Fr.
RN8586	4¼" (108mm)	6 Fr.
RN8587	4¼" (108mm)	7 Fr.
RN8588	4¼" (108mm)	8 Fr.
RN8589	4¼" (108mm)	9 Fr.
RN85810	4¼" (108mm)	10 Fr.
RN85811	4¼" (108mm)	11 Fr.
RN85812	4¼" (108mm)	12 Fr.



RN85612



RN85812

straight, overall length 9¼" (235mm)

Catalog #	Working Length	Fr. Size
RN8763	7" (178mm)	3 Fr.
RN8764	7" (178mm)	4 Fr.
RN8765	7" (178mm)	5 Fr.
RN8766	7" (178mm)	6 Fr.
RN8767	7" (178mm)	7 Fr.
RN8768	7" (178mm)	8 Fr.
RN8769	7" (178mm)	9 Fr.
RN87610	7" (178mm)	10 Fr.
RN87611	7" (178mm)	11 Fr.
RN87612	7" (178mm)	12 Fr.

angled, overall length 8½" (216mm)

Catalog #	Working Length	Fr. Size
RN8783	5¾" (146mm)	3 Fr.
RN8784	5¾" (146mm)	4 Fr.
RN8785	5¾" (146mm)	5 Fr.
RN8786	5¾" (146mm)	6 Fr.
RN8787	5¾" (146mm)	7 Fr.
RN8788	5¾" (146mm)	8 Fr.
RN8789	5¾" (146mm)	9 Fr.
RN87810	5¾" (146mm)	10 Fr.
RN87811	5¾" (146mm)	11 Fr.
RN87812	5¾" (146mm)	12 Fr.

	○	○	○	○	○	○	○	○	○	○
French	3 Fr.	4 Fr.	5 Fr.	6 Fr.	7 Fr.	8 Fr.	9 Fr.	10 Fr.	11 Fr.	12 Fr.
Inches	.039	.053	.066	.079	.092	.105	.118	.131	.144	.158
Millimeters	1	1.4	1.7	2.0	2.3	2.7	3.0	3.3	3.7	4.0

**Frazier Suction Tubes**

semi-rigid with slot

straight, overall length 7¾" (195mm)

Catalog #	Working Length	Fr. Size
RN8503	5½" (140mm)	3 Fr.
RN8504	5½" (140mm)	4 Fr.
RN8505	5½" (140mm)	5 Fr.
RN8506	5½" (140mm)	6 Fr.
RN8507	5½" (140mm)	7 Fr.
RN8508	5½" (140mm)	8 Fr.
RN8509	5½" (140mm)	9 Fr.
RN8510	5½" (140mm)	10 Fr.
RN8511	5½" (140mm)	11 Fr.
RN8512	5½" (140mm)	12 Fr.

angled, overall length 7" (178mm)

Catalog #	Working Length	Fr. Size
RN8523	4¼" (108mm)	3 Fr.
RN8524	4¼" (108mm)	4 Fr.
RN8525	4¼" (108mm)	5 Fr.
RN8526	4¼" (108mm)	6 Fr.
RN8527	4¼" (108mm)	7 Fr.
RN8528	4¼" (108mm)	8 Fr.
RN8529	4¼" (108mm)	9 Fr.
RN85210	4¼" (108mm)	10 Fr.
RN85211	4¼" (108mm)	11 Fr.
RN85212	4¼" (108mm)	12 Fr.



RN8512



RN8523

straight, overall length 9¼" (235mm)

Catalog #	Working Length	Fr. Size
RN8703	7" (178mm)	3 Fr.
RN8704	7" (178mm)	4 Fr.
RN8705	7" (178mm)	5 Fr.
RN8706	7" (178mm)	6 Fr.
RN8707	7" (178mm)	7 Fr.
RN8708	7" (178mm)	8 Fr.
RN8709	7" (178mm)	9 Fr.
RN8710	7" (178mm)	10 Fr.
RN8711	7" (178mm)	11 Fr.
RN8712	7" (178mm)	12 Fr.

angled, overall length 8½" (216mm)

Catalog #	Working Length	Fr. Size
RN8723	5¾" (146mm)	3 Fr.
RN8724	5¾" (146mm)	4 Fr.
RN8725	5¾" (146mm)	5 Fr.
RN8726	5¾" (146mm)	6 Fr.
RN8727	5¾" (146mm)	7 Fr.
RN8728	5¾" (146mm)	8 Fr.
RN8729	5¾" (146mm)	9 Fr.
RN87210	5¾" (146mm)	10 Fr.
RN87211	5¾" (146mm)	11 Fr.
RN87212	5¾" (146mm)	12 Fr.



	○	○	○	○	○	○	○	○	○	○
French	3 Fr.	4 Fr.	5 Fr.	6 Fr.	7 Fr.	8 Fr.	9 Fr.	10 Fr.	11 Fr.	12 Fr.
Inches	.039	.053	.066	.079	.092	.105	.118	.131	.144	.158
Millimeters	1	1.4	1.7	2.0	2.3	2.7	3.0	3.3	3.7	4.0

### Frazier Suction Tubes

malleable with hole  
angled, overall length 7¾" (195mm)

Catalog #	Working Length	Fr. Size
RO708	4⅛" (105mm)	3 Fr.
RO707	4⅛" (105mm)	5 Fr.
RO710	4⅛" (105mm)	6 Fr.
RO711	4⅛" (105mm)	7 Fr.
RO712	4⅛" (105mm)	8 Fr.
RO713	4⅛" (105mm)	9 Fr.
RO714	4⅛" (105mm)	10 Fr.
RO715	4⅛" (105mm)	11 Fr.
RO716	4⅛" (105mm)	12 Fr.

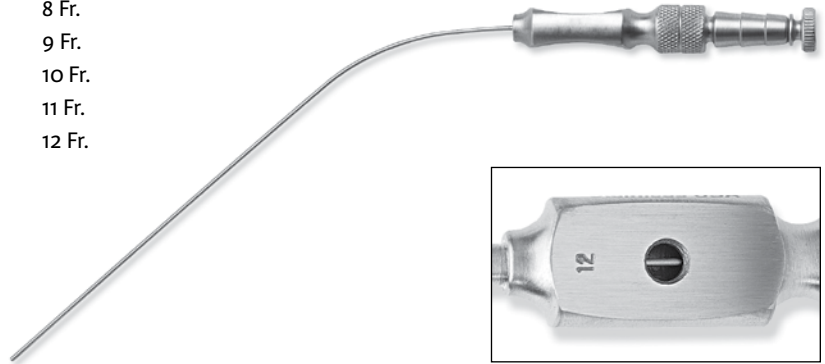

RO708

### Frazier Suction Tubes

malleable with hole  
angled, overall length 9" (229mm)

Catalog #	Working Length	Fr. Size
RO778	5¾" (146mm)	3 Fr.
RO777	5¾" (146mm)	5 Fr.
RO770	5¾" (146mm)	6 Fr.
RO771	5¾" (146mm)	7 Fr.
RO772	5¾" (146mm)	8 Fr.
RO773	5¾" (146mm)	9 Fr.
RO774	5¾" (146mm)	10 Fr.
RO775	5¾" (146mm)	11 Fr.
RO776	5¾" (146mm)	12 Fr.

	○	○	○	○	○	○	○	○	○	○	○
French	3 Fr.	4 Fr.	5 Fr.	6 Fr.	7 Fr.	8 Fr.	9 Fr.	10 Fr.	11 Fr.	12 Fr.	15 Fr.
Inches	.039	.053	.066	.079	.092	.105	.118	.131	.144	.158	.197
Millimeters	1	1.4	1.7	2.0	2.3	2.7	3.0	3.3	3.7	4.0	5.0

**Poppen Suction Tubes**

malleable with slot  
angled, overall length 6¼" (158mm)

Catalog #	Working Length	Fr. Size
Ro658	3¾" (95mm)	6 Fr.
Ro659	3¾" (95mm)	7 Fr.
Ro660	3¾" (95mm)	8 Fr.
Ro661	3¾" (95mm)	9 Fr.
Ro662	3¾" (95mm)	10 Fr.
Ro663	3¾" (95mm)	11 Fr.
Ro664	3¾" (95mm)	12 Fr.

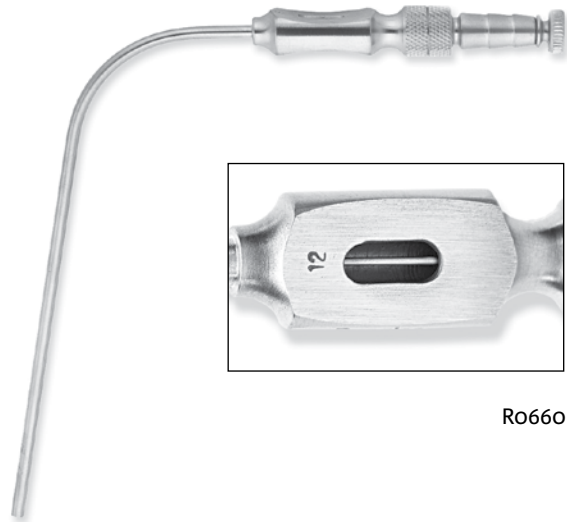

Ro660

**Frazier Suction Tubes**

malleable with slot  
angled, overall length 7¾" (200mm)

Catalog #	Working Length	Fr. Size
Ro785	5¾" (146mm)	6 Fr.
Ro786	5¾" (146mm)	7 Fr.
Ro787	5¾" (146mm)	8 Fr.
Ro788	5¾" (146mm)	9 Fr.
Ro789	5¾" (146mm)	10 Fr.
Ro790	5¾" (146mm)	11 Fr.
Ro791	5¾" (146mm)	12 Fr.

**Adson Suction Tubes**

curved

Catalog #	Working Length	Overall Length	Fr. Size
RN8612	3¼" (83mm)	5½" (140mm)	12 Fr.
RN8615	5¼" (133mm)	7½" (191mm)	15 Fr.



RN8612

	○	○	○	○	○	○	○	○	○	○
French	3 Fr.	4 Fr.	5 Fr.	6 Fr.	7 Fr.	8 Fr.	9 Fr.	10 Fr.	11 Fr.	12 Fr.
Inches	.039	.053	.066	.079	.092	.105	.118	.131	.144	.158
Millimeters	1	1.4	1.7	2.0	2.3	2.7	3.0	3.3	3.7	4.0

**Atraumatic Tip Suction Tubes with Multiple Holes**

malleable, 6 holes at tip  
angled, overall length 8 1/4" (210mm)

Catalog #	Working Length	Fr. Size
Ro674	5 3/8" (135mm)	3 Fr.
Ro675	5 3/8" (135mm)	5 Fr.
Ro676	5 3/8" (135mm)	6 Fr.
Ro677	5 3/8" (135mm)	7 Fr.
Ro678	5 3/8" (135mm)	8 Fr.
Ro679	5 3/8" (135mm)	9 Fr.
Ro680	5 3/8" (135mm)	10 Fr.
Ro681	5 3/8" (135mm)	11 Fr.
Ro682	5 3/8" (135mm)	12 Fr.

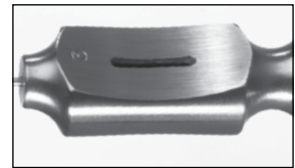
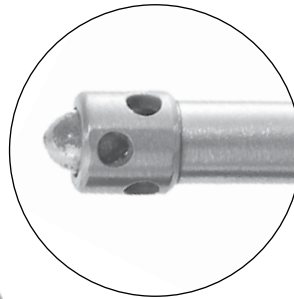

**Multi-Hole Suction Tubes**

5 holes at tip  
angled, overall length 7" (175mm)

Catalog #	Working Length	Fr. Size
RN9625	4 1/2" (114mm)	5 Fr.
RN9627	4 1/2" (114mm)	7 Fr.

Ro681

**Multi-Hole Suction Tubes**

5 holes at tip  
angled, overall length 8 3/4" (225mm)

Catalog #	Working Length	Fr. Size
RN9725	6 1/2" (165mm)	5 Fr.
RN9727	6 1/2" (165mm)	7 Fr.

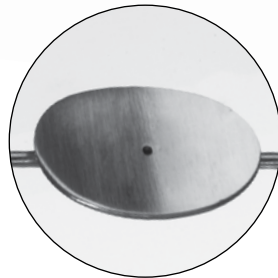

RN9625

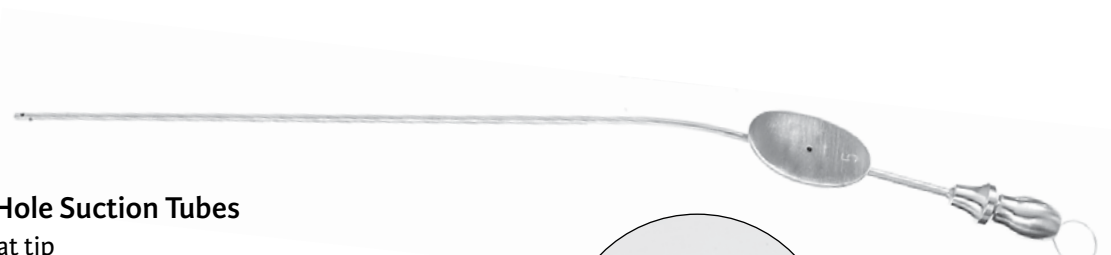
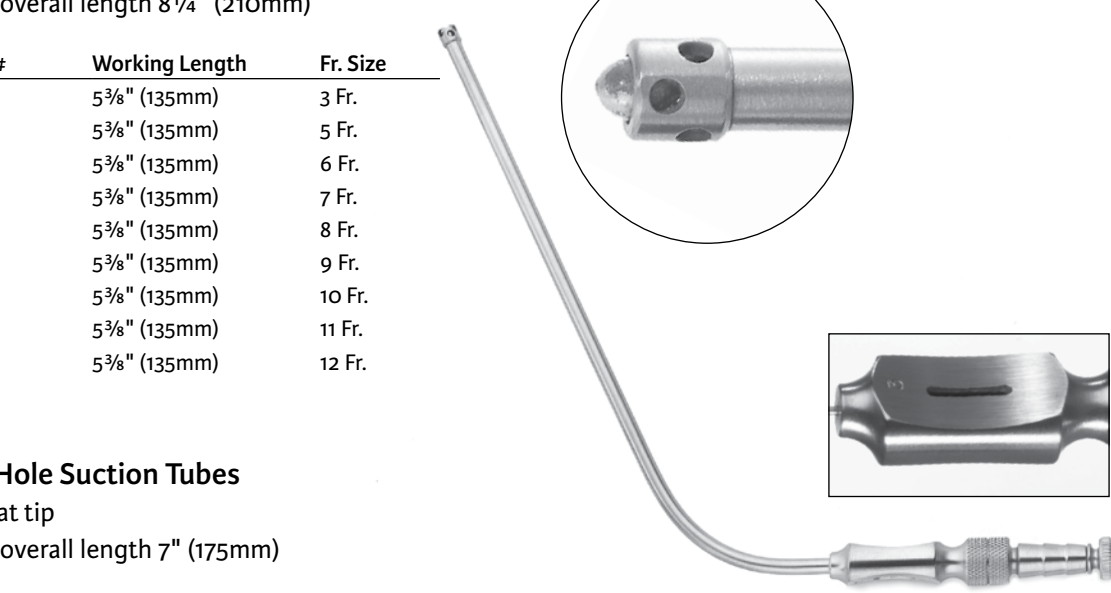

	○	○	○	○	○
French	3 Fr.	5 Fr.	7 Fr.	10 Fr.	12 Fr.
Inches	.039	.066	.092	.131	.158
Millimeters	1	1.7	2.3	3.3	4.0

### Atraumatic Tip Suction Tubes

angled, overall length 6¼" (157mm)

Catalog #	Working Length	Fr. Size
RN9103	3⅛" (80mm)	3 Fr.
RN9105	3⅛" (80mm)	5 Fr.
RN9107	3⅛" (80mm)	7 Fr.
RN9110	3⅛" (80mm)	10 Fr.
RN9112	3⅛" (80mm)	12 Fr.

### Atraumatic Tip Suction Tubes

angled, overall length 7" (176mm)

Catalog #	Working Length	Fr. Size
RN9203	3⅞" (100mm)	3 Fr.
RN9205	3⅞" (100mm)	5 Fr.
RN9207	3⅞" (100mm)	7 Fr.
RN9210	3⅞" (100mm)	10 Fr.
RN9212	3⅞" (100mm)	12 Fr.

### Atraumatic Tip Suction Tubes

angled, overall length 8" (203mm)

Catalog #	Working Length	Fr. Size
RN9303	4¾" (121mm)	3 Fr.
RN9305	4¾" (121mm)	5 Fr.
RN9307	4¾" (121mm)	7 Fr.
RN9310	4¾" (121mm)	10 Fr.
RN9312	4¾" (121mm)	12 Fr.



RN9307

	○	○	○
French	5 Fr.	7 Fr.	10 Fr.
Inches	.066	.092	.131
Millimeters	1.7	2.3	3.3

**Atraumatic Tip Suction Tubes**  
curved down, overall length 8 1/4" (210mm)

Catalog #	Working Length	Fr. Size
RN9505	5 1/2" (140mm)	5 Fr.
RN9507	5 1/2" (140mm)	7 Fr.
RN9510	5 1/2" (140mm)	10 Fr.



RN9507

**Atraumatic Tip Suction Tubes**  
curved up, overall length 8 1/4" (210mm)

Catalog #	Working Length	Fr. Size
RN9405	5 1/2" (140mm)	5 Fr.
RN9407	5 1/2" (140mm)	7 Fr.
RN9410	5 1/2" (140mm)	10 Fr.



RN9407

	○	○	○
French	5 Fr.	7 Fr.	11 Fr.
Inches	.066	.092	.144
Millimeters	1.7	2.3	3.7

**Endonasal Suction Tubes**

overall length 8" (203mm)

Catalog #	Description	Working Length	Fr. Size
RN82325	Short Curve Up	4¾" (121mm)	5 Fr.
RN82327	Short Curve Up	4¾" (121mm)	7 Fr.
RN82425	Long Curve Up	4¾" (121mm)	5 Fr.
RN82427	Long Curve Up	4¾" (121mm)	7 Fr.
RN82525	Straight	4¾" (121mm)	5 Fr.
RN82527	Straight	4¾" (121mm)	7 Fr.
RN825211	Straight	4¾" (121mm)	11 Fr.
RN82625	Short Curve Down	4¾" (121mm)	5 Fr.
RN82627	Short Curve Down	4¾" (121mm)	7 Fr.
RN82725	Long Curve Down	4¾" (121mm)	5 Fr.
RN82727	Long Curve Down	4¾" (121mm)	7 Fr.



	○	○	○	○	○	○	○	○	○	○
French	3 Fr.	4 Fr.	5 Fr.	6 Fr.	7 Fr.	8 Fr.	9 Fr.	10 Fr.	11 Fr.	12 Fr.
Inches	.039	.053	.066	.079	.092	.105	.118	.131	.144	.158
Millimeters	1	1.4	1.7	2.0	2.3	2.7	3.0	3.3	3.7	4.0

**Tapered Teardrop Suction Tubes**

semi-rigid, overall length 8 1/4" (210mm)

Catalog #	Working Length	Fr. Size
RN8253	5 1/4" (133mm)	3 Fr.
RN8254	5 1/2" (140mm)	4 Fr.
RN8255	5 1/2" (140mm)	5 Fr.
RN8256	5 1/2" (140mm)	6 Fr.
RN8257	5 1/2" (140mm)	7 Fr.
RN8258	5 1/2" (140mm)	8 Fr.
RN8259	5 1/2" (140mm)	9 Fr.
RN82510	5 1/2" (140mm)	10 Fr.
RN82512	5 1/4" (133mm)	12 Fr.

semi-rigid, overall length 9 1/4" (235mm)

Catalog #	Working Length	Fr. Size
RN8263	6 1/4" (159mm)	3 Fr.
RN8264	6 1/4" (159mm)	4 Fr.
RN8265	6 1/4" (159mm)	5 Fr.
RN8266	6 1/4" (159mm)	6 Fr.
RN8267	6 1/4" (159mm)	7 Fr.
RN8268	6 1/4" (159mm)	8 Fr.
RN8269	6 1/4" (159mm)	9 Fr.
RN82610	6 1/4" (159mm)	10 Fr.
RN82612	6 1/4" (159mm)	12 Fr.

semi-rigid, overall length 10 1/4" (260mm)

Catalog #	Working Length	Fr. Size
RN8283	7" (178mm)	3 Fr.
RN8284	7" (178mm)	4 Fr.
RN8285	7" (178mm)	5 Fr.
RN8286	7" (178mm)	6 Fr.
RN8287	7" (178mm)	7 Fr.
RN8288	7" (178mm)	8 Fr.
RN8289	7" (178mm)	9 Fr.
RN82810	7" (178mm)	10 Fr.
RN82812	7" (178mm)	11 Fr.
RN87612	7" (178mm)	12 Fr.



RN8264

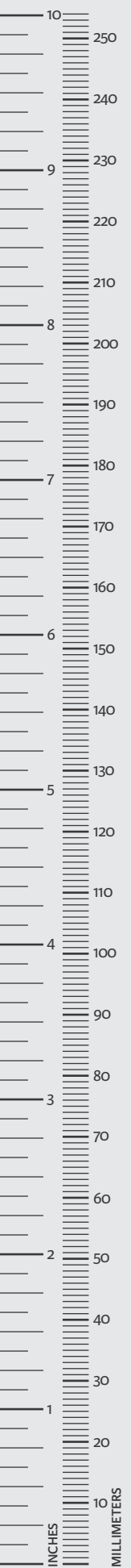

	○	○	○	○	○	○	○	○	○	○
French	3 Fr.	4 Fr.	5 Fr.	6 Fr.	7 Fr.	8 Fr.	9 Fr.	10 Fr.	11 Fr.	12 Fr.
Inches	.039	.053	.066	.079	.092	.105	.118	.131	.144	.158
Millimeters	1	1.4	1.7	2.0	2.3	2.7	3.0	3.3	3.7	4.0

**T. Fukushima Tapered Teardrop Suction Tubes**

malleable, overall length 6½" (165mm)

Catalog #	Working Length	Fr. Size
R9007	3¼" (83mm)	3 Fr.
R9000	3¼" (83mm)	3 Fr.
R8980	3¼" (83mm)	4 Fr.
R8981	3¼" (83mm)	5 Fr.
R8982	3¼" (83mm)	6 Fr.
R8983	3¼" (83mm)	7 Fr.
R8984	3¼" (83mm)	8 Fr.
R8985	3¼" (83mm)	9 Fr.
R9042	3¼" (83mm)	10 Fr.
RB8631	3¼" (83mm)	11 Fr.
R9043	3¼" (83mm)	12 Fr.

malleable, overall length 8" (203mm)

Catalog #	Working Length	Fr. Size
R9009	4¾" (120mm)	2 Fr.
R9002	4¾" (120mm)	3 Fr.
R8992	4¾" (120mm)	4 Fr.
R8993	4¾" (120mm)	5 Fr.
R8994	4¾" (120mm)	6 Fr.
R8995	4¾" (120mm)	7 Fr.
R8996	4¾" (120mm)	8 Fr.
R8997	4¾" (120mm)	9 Fr.
R9046	4¾" (120mm)	10 Fr.
RB8831	4¾" (120mm)	11 Fr.
R9047	4¾" (120mm)	12 Fr.

malleable, overall length 7" (178mm)

Catalog #	Working Length	Fr. Size
R9008	4" (102mm)	2 Fr.
R9001	4" (102mm)	3 Fr.
R8986	4" (102mm)	4 Fr.
R8987	4" (102mm)	5 Fr.
R8988	4" (102mm)	6 Fr.
R8989	4" (102mm)	7 Fr.
R8990	4" (102mm)	8 Fr.
R8991	4" (102mm)	9 Fr.
R9044	4" (102mm)	10 Fr.
RB8731	4" (102mm)	11 Fr.
R9045	4" (102mm)	12 Fr.

angled, overall length 9" (229mm)

Catalog #	Working Length	Fr. Size
R9010	5¾" (146mm)	2 Fr.
R9003	5¾" (146mm)	3 Fr.
R9004	5¾" (146mm)	4 Fr.
R9005	5¾" (146mm)	5 Fr.
R9006	5¾" (146mm)	6 Fr.
R8965	5¾" (146mm)	7 Fr.
R8966	5¾" (146mm)	8 Fr.
R8967	5¾" (146mm)	9 Fr.
R8968	5¾" (146mm)	10 Fr.
R8969	5¾" (146mm)	11 Fr.
R8970	5¾" (146mm)	12 Fr.

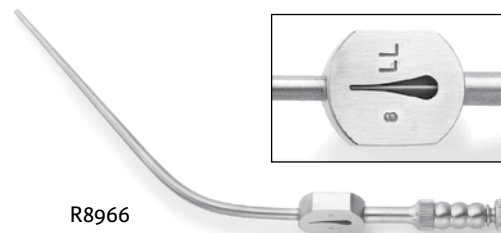



	○	○	○	○	○	○	○	○	○
Fr ench	3 Fr.	4 Fr.	5 Fr.	6 Fr.	7 Fr.	8 Fr.	9 Fr.	10 Fr.	12 Fr.
Inches	.039	.053	.066	.079	.092	.105	.118	.131	.158
Millimeters	1	1.4	1.7	2.0	2.3	2.7	3.0	3.3	4.0

**Tapered Teardrop Suction Tubes**

super malleable, overall length 8 1/4" (210mm)

Catalog #	Working Length	Fr. Size
R9012SM	5 3/4" (146mm)	2 Fr.
R9013SM	5 3/4" (146mm)	3 Fr.
R9014SM	5 3/4" (146mm)	4 Fr.
R9015SM	5 3/4" (146mm)	5 Fr.
R9016SM	5 3/4" (146mm)	6 Fr.
R9017SM	5 3/4" (146mm)	7 Fr.
R9018SM	5 3/4" (146mm)	8 Fr.
R9019SM	5 3/4" (146mm)	9 Fr.
R9020SM	5 3/4" (146mm)	10 Fr.
R9021SM	5 3/4" (146mm)	12 Fr.

super malleable, overall length 9 1/2" (241mm)

Catalog #	Working Length	Fr. Size
R9008SM	7" (178mm)	2 Fr.
R9001SM	7" (178mm)	3 Fr.
R8986SM	7" (178mm)	4 Fr.
R8987SM	7" (178mm)	5 Fr.
R8988SM	7" (178mm)	6 Fr.
R8989SM	7" (178mm)	7 Fr.
R8990SM	7" (178mm)	8 Fr.
R8991SM	7" (178mm)	9 Fr.
R9044SM	7" (178mm)	10 Fr.
R9045SM	7" (178mm)	12 Fr.

super malleable, overall length 8 3/4" (222mm)

Catalog #	Working Length	Fr. Size
R9007SM	6 1/2" (165mm)	2 Fr.
R9000SM	6 1/2" (165mm)	3 Fr.
R8980SM	6 1/2" (165mm)	4 Fr.
R8981SM	6 1/2" (165mm)	5 Fr.
R8982SM	6 1/2" (165mm)	6 Fr.
R8983SM	6 1/2" (165mm)	7 Fr.
R8984SM	6 1/2" (165mm)	8 Fr.
R8985SM	6 1/2" (165mm)	9 Fr.
R9042SM	6 1/2" (165mm)	10 Fr.
R9043SM	6 1/2" (165mm)	12 Fr.

super malleable, overall length 10 1/2" (267mm)

Catalog #	Working Length	Fr. Size
R9009SM	8" (203mm)	2 Fr.
R9002SM	8" (203mm)	3 Fr.
R8992SM	8" (203mm)	4 Fr.
R8993SM	8" (203mm)	5 Fr.
R8994SM	8" (203mm)	6 Fr.
R8995SM	8" (203mm)	7 Fr.
R8996SM	8" (203mm)	8 Fr.
R8997SM	8" (203mm)	9 Fr.
R9046SM	8" (203mm)	10 Fr.
R9047SM	8" (203mm)	12 Fr.



R9008SM



# **Integra<sup>®</sup>** Microsurgical Instrumentation

### Micro Dissection Set

Catalog# \_\_\_\_\_

**RN6200**

Set includes one each of items RN6201 through RN6215 (see next page) and one Instrument Tray RN6220

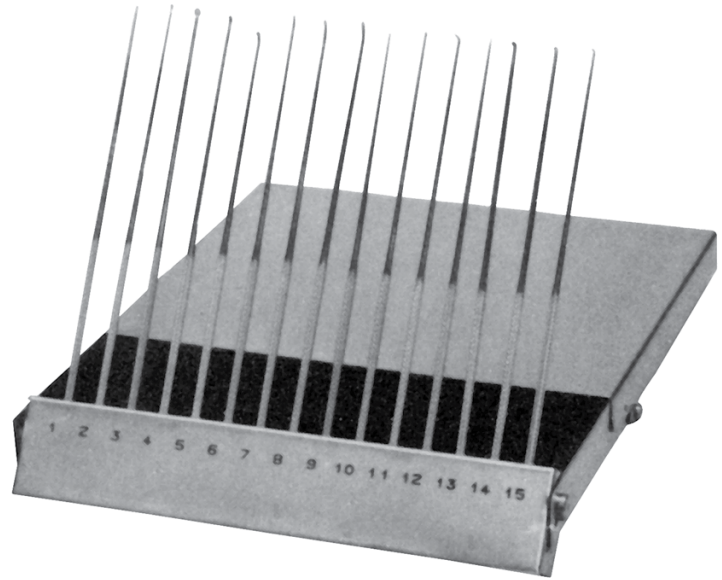

### Micro Dissection Set - Expanded

Catalog# \_\_\_\_\_

**RN6230**

Set includes one each of items RN6201 through RN6219 (see next page) and one Instrument Tray RS6219



### Rhoton Style Micro Dissection Set Components

7 1/2" (190mm) length

#### Dissectors

Catalog#	Tip Diameter	Style
RN6201	1mm	#1
RN6202	2mm	#2
RN6203	3mm	#3

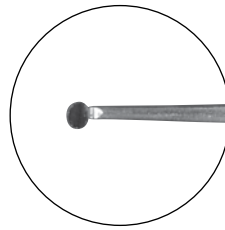

RN6201

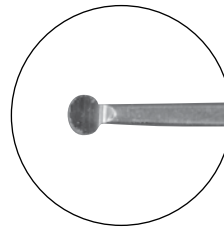

RN6202

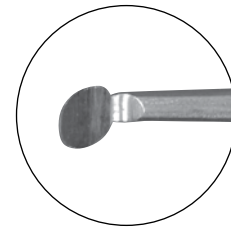

RN6203

#### Elevators

Catalog#	Description	Tip Width	Style
RN6204	Curved	2.6mm	#4
RN6205	Angled	1.3mm	#5

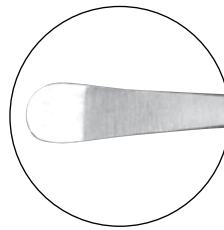

RN6204

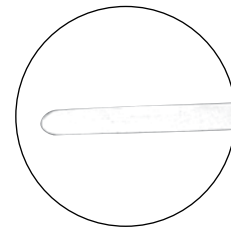

RN6205

#### Spatula Dissectors

Catalog#	Description	Tip Width	Style
RN6206	Small	1mm	#6
RN6207	Medium	1.5mm	#7
RN6208	Large	2mm	#8

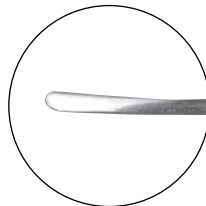

RN6206

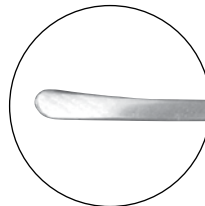

RN6207

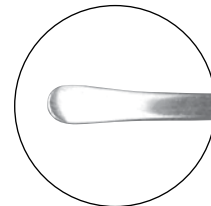

RN6208

#### Right Angle Hooks

Catalog#	Description	Hook Length	Style
RN6209	Semi-Sharp	2mm	#9
RN6210	Blunt	3mm	#10

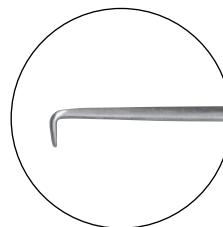

RN6209

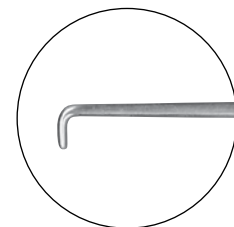

RN6210

**Rhoton Style Micro Dissection Set Components, continued**  
7½" (190mm) length

**Needle Dissectors**

Catalog#	Description	Cup Size	Style
RN6211	Semi-Sharp, 45° Angle	3mm	#11
RN6212	Semi-Sharp, Straight	5mm	#12

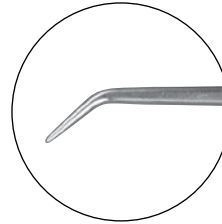

RN6211

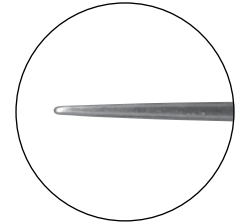

RN6212

**Micro Curettes**

Catalog#	Description	Cup Size	Style
RN6213	Straight	1 x 2mm	#13
RN6214	Angled	1 x 2mm	#14

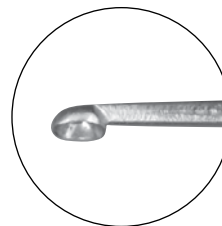

RN6213

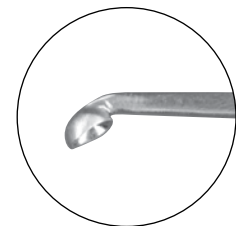

RN6214

**Ball Dissectors**

Catalog#	Description	Tip Length	Style
RN6215	90° Angle	3mm	#16
RN6216	90° Angle	5mm	#17
RN6217	45° Angle	4mm	#18
RN6218	45° Angle	8mm	#19
RN6219	Straight		#15

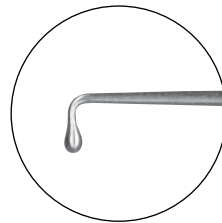

RN6215

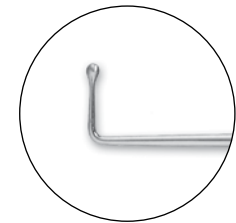

RN6216

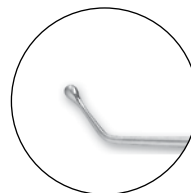

RN6217

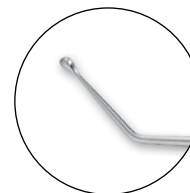

RN6218

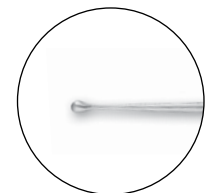

RN6219

**Micro Dissection Set Tray**

Catalog# \_\_\_\_\_  
RN6220



**Micro Dissection Set Tray - Expanded**

Catalog# \_\_\_\_\_  
RS6219



## Apfelbaum Dissecting Instruments

Straight, 8<sup>3</sup>/<sub>4</sub>" (222mm) length

### Round Dissectors

Catalog#	Description	Tip Width
RN6701	Sharp Edges	1mm
RN6702	Sharp Edges	2mm
RN6703	Sharp Edges	3mm

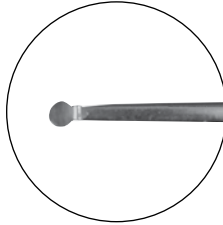

RN6701

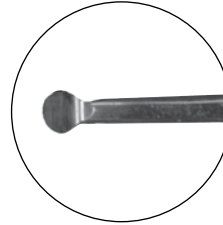

RN6702

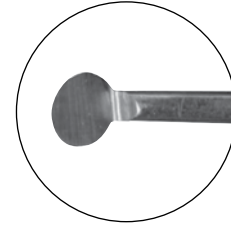

RN6703

### Elevators

Catalog#	Description	Tip Width
RN6704	Wide	2.4mm
RN6705	Narrow	1.9mm

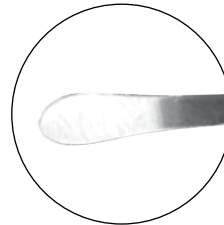

RN6704

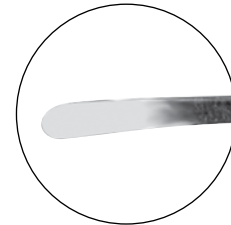

RN6705

### Spatula Dissectors

Catalog#	Description	Tip Width
RN6706	Curved	1mm
RN6707	Angled	1mm
RN6708	90°	

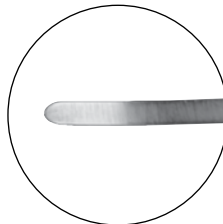

RN6706

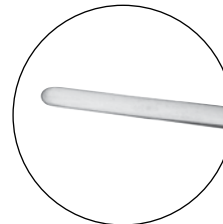

RN6707

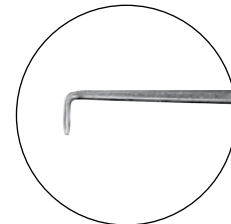

RN6708

**Apfelbaum Dissecting Instruments, continued**  
straight, 8<sup>3</sup>/<sub>4</sub>" (222mm) length

**Right Angle Hook**

Catalog#	Description
RN6709	45°

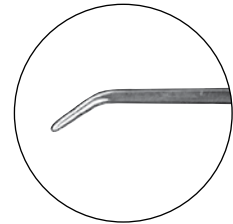

RN6709

**Teardrop Dissectors**

Catalog#	Description	Tip Size
RN6710	90°	1 x 3.4mm
RN6711	45°	1 x 3.4mm

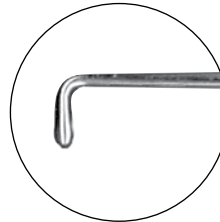

RN6710

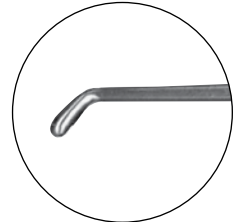

RN6711

**Dura Knives**

Catalog#	Description
RN6712	Large
RN6713	Small



RN6712



RN6713

**Curettes**

Catalog#	Description	Cup Size
RN6714	Angled	1mm
RN6715	Angled	2mm
RN6716	Double Angled	1mm
RN6717	Double Angled	2mm



RN6714

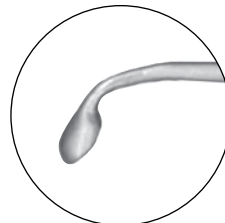

RN6715



RN6716



RN6717

**Apfelbaum Micro Dissection Tray**

Catalog#	Description
RS6700	Straight Holds RN6701 through RN6717



## Apfelbaum Dissecting Instruments

angled, 8<sup>3</sup>/<sub>4</sub>" (222mm) length

### Round Dissectors

Catalog#	Description	Tip Width
RN6601	Sharp Edges	1mm
RN6602	Sharp Edges	2mm
RN6603	Sharp Edges	3mm

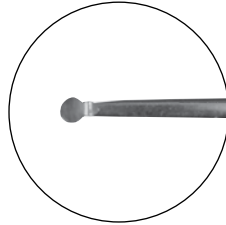

RN6601

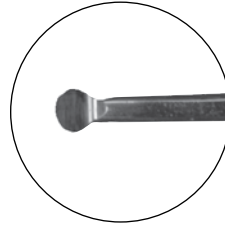

RN6602

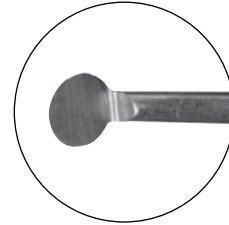

RN6603

### Elevators

Catalog#	Description	Tip Width
RN6604	Wide	2.5mm
RN6605	Narrow	2mm

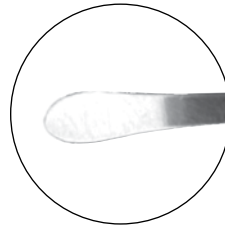

RN6604

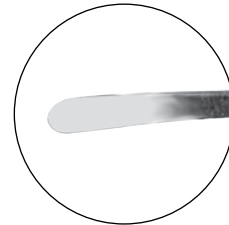

RN6605

### Spatula Dissectors

Catalog#	Description
RN6606	Curved
RN6607	Angled
RN6608	90°

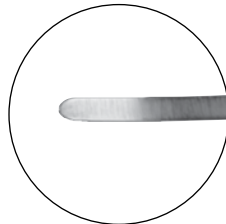

RN6606

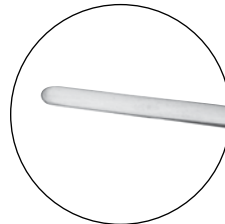

RN6607

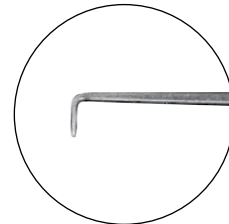

RN6608



**Apfelbaum Dissecting Instruments - Continued**  
angled, 8<sup>3</sup>/<sub>4</sub>" (222mm) length

**Right Angle Hook**

Catalog#	Description
RN6609	45°

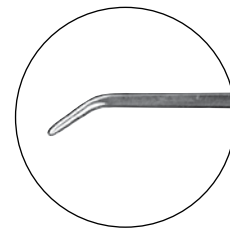

RN6609

**Teardrop Dissectors**

Catalog#	Description
RN6610	90°
RN6611	45°

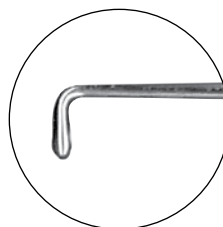

RN6610

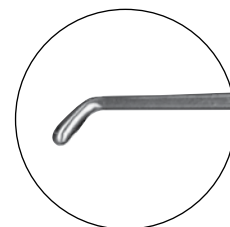

RN6611

**Dura Knives**

Catalog#	Description
RN6612	Large
RN6613	Small



RN6612



RN6613

**Curettes**

Catalog#	Description	Cup Size
RN6614	Angled	1mm
RN6615	Angled	2mm
RN6616	Double Angled	1mm
RN6617	Double Angled	2mm



RN6614

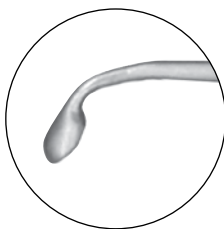

RN6615



RN6616



RN6617

**Apfelbaum Dissection Tray (not pictured)**

Catalog#	Description
RS6600	Angled Holds RN6601 through RN6617

### Apfelbaum Micro Dissection Mirror

Catalog#	Length	Tip Width
RN6626	9" (229mm)	6mm

### Micro Dissection Set

straight, 7¼" (185mm) length



### Yasargil Ligature Carriers

Catalog#	Description	Tip Width
R8401	Slight Curve	1.4mm
R8402	Strong Curve	1.4mm
R8403	Angled	1.4mm



R8401



R8402

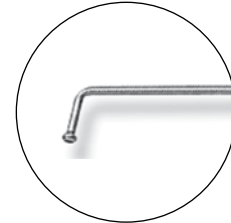

R8403

### Jacobson Vessel Knife

Catalog#	Description	Tip Length
R8408	Straight	3mm

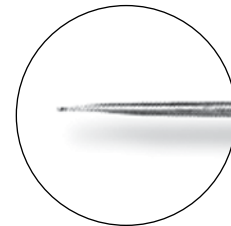

R8408

### Raspatory

Catalog#	Description	Tip Length
R8409	Angled	8mm

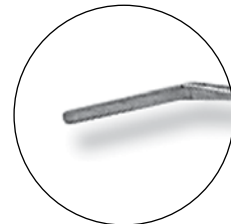

R8409

### Dissector

Catalog#	Description	Tip Length
R8410	Angled	9mm

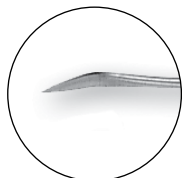

**Micro Dissection Set, Continued**  
straight, 7¼" (185mm) length

**Raspatory**

Catalog#	Description	Blade Size
R8411	Large Wide Large	3.2 x 6.7mm
R8412	Narrow Light Curve	3 x 20 mm
R8413	Narrow Strong Curve	3 x 20mm

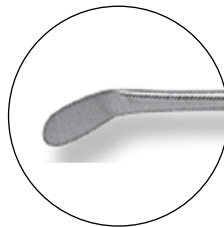

R8411

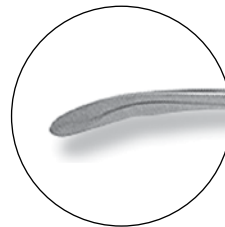

R8412

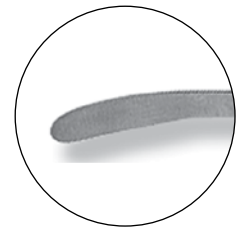

R8413

**Jacobson Probe**

Catalog#	Description
R8414	Angled, Ball Tip, 9mm
R8415	Straight, Double Ball Tip, 10mm

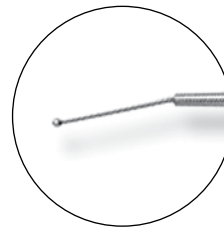

R8414

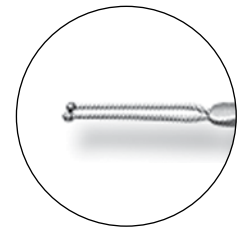

R8415

**Jacobson Micro Suture Pusher**

Catalog#	Description	Tip Width
R8416	Double Prong Tip	2mm

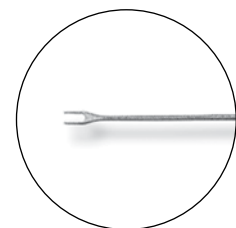

R8416

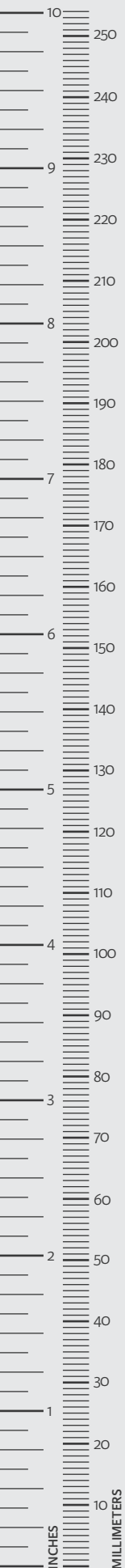

**F-G Fukushima-Giannotta Skullbase and Micro Dissectors**

7¼" (184mm)

**Tray**

Catalog#	Description
R8977	Holds R8935 through R8958

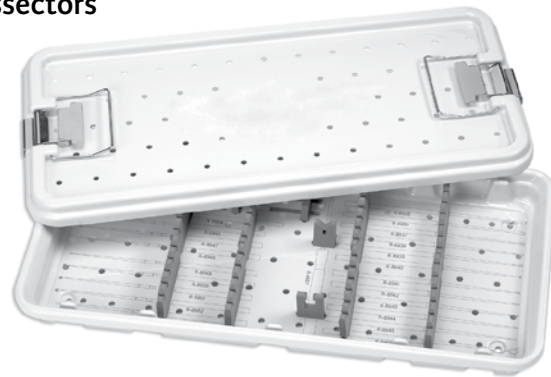

**Dissectors**

Catalog#	Description	Tip Width
R8935	Slightly Curved	3mm
R8936	Very Curved	3mm
R8937	Duckbill Curved	2.5mm
R8938	Slightly Curved	2mm
R8939	Very Curved	1.8mm



R8935



R8935



R8936

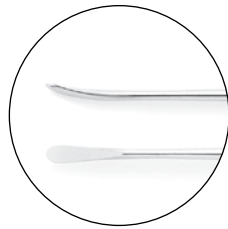

R8937

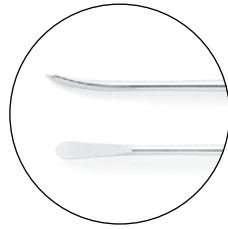

R8938

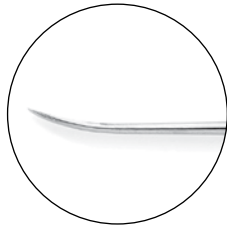

R8939

**Knife**

Catalog#	Description	Tip Width
R8940	Round Angle	2mm

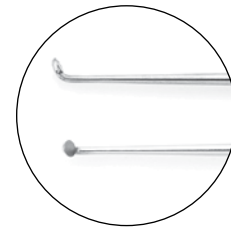

R8940

**Hook**

Catalog#	Description	Tip Width
R8941	90° Straight	1.1mm

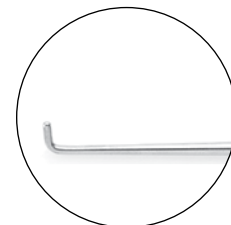

R8941

**F-G Fukushima-Giannotta Skullbase and Micro Dissectors, Continued**  
7¼" (184mm)

**Knives**

Catalog#	Description	Tip Length
R8942	90° Sharp Tip	4.1mm
R8943	90° Blunt Tip	4.9mm
R8944	45° Sharp Tip	4.5mm

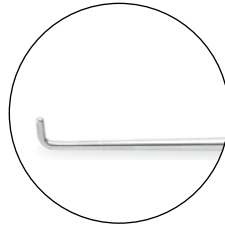

R8942

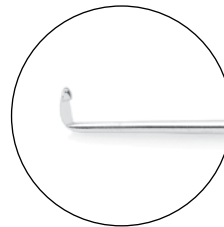

R8943

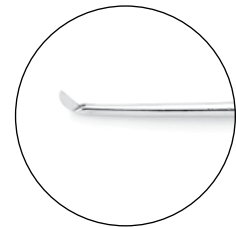

R8944

**Probe**

Catalog#	Description
R8945	Straight Bullet Tip

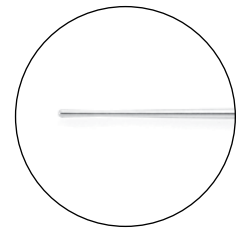

R8945

**Separators**

Catalog#	Description	Tip Length
R8954	Slight Curve	4mm
R8955	90°	4mm



R8954



R8955

**Fukushima-Giannotta Skull Base and Micro Dissectors, Continued**  
7¼" (184mm)

**Bayonet Probes**

Catalog#	Description	Tip Length
R8946	Straight, Bullet Tip	-
R8947	30° Bullet Tip	2.8mm
R8948	60° Bullet Tip	3.7mm
R8949	90° Bullet Tip	4.9mm



R8946

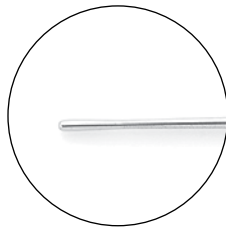

R8946

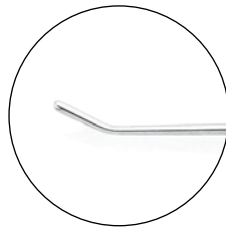

R8947

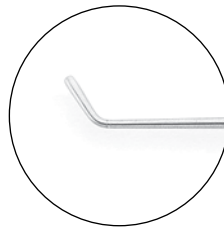

R8948

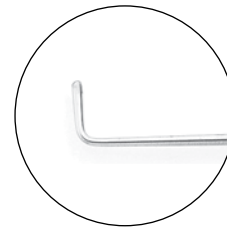

R8949

**Ring Currettes**

Catalog#	Description	Ring Size
R8950	2.5mm, 45° Up, Sharp	2.5mm
R8951	3mm, 45° Up, Sharp	3mm
R8952	4mm, 45° Up, Sharp	4mm



R8950

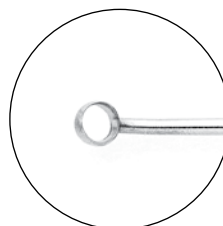

R8951



R8952

**Fukushima-Giannotta Skull Base and Micro Dissectors, Continued**  
7¼" (184mm)

**Cup Curette**

Catalog#	Description	Cup Size
R8953	20° Up	2 x 3mm



R8953

**Probe Dissector, Insulated**

Catalog#	Description	Tip Width
R8956	Touch Spring for Electrocautery	3mm

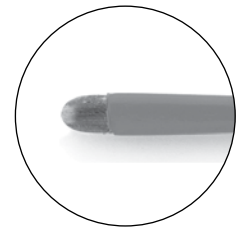

**Probe, Insulated**

Catalog#	Description	Tip Width
R8958	Touch Spring for Electrocautery	4mm



**Fukushima-Chen Cerebellar Pontine Tumor Bayonet Micro Instruments**  
7½" (191mm)

**Knives**

Catalog#	Description	Tip Length
R8876	Very Sharp, Blunt Tip	-
R8877	45° Up, Semi-Blunt	2.5mm
R8878	45° Up, Sharp	3mm
R8879	80° Up, Sharp Tip and Edge	2.5mm
R8881	Sickle Style, Very Thin, Sharp	8mm

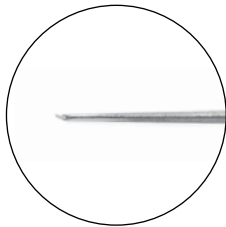

R8876

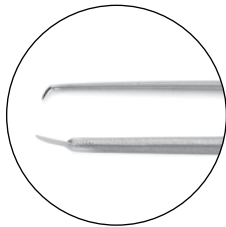

R8877

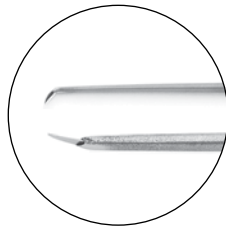

R8878

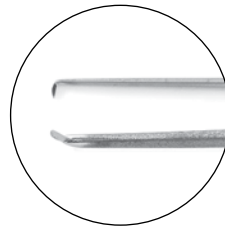

R8879

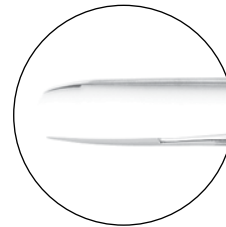

R8881





**Fukushima-Chen Cerebellar Pontine Tumor Bayonet Micro Instruments, Continued**  
7½" (191mm)

**Knives**

Catalog#	Description	Tip Diameter
R8887	Angled, Very Sharp	1mm
R8888	Angled, Very Sharp	1.5mm

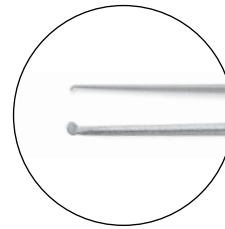

R8887

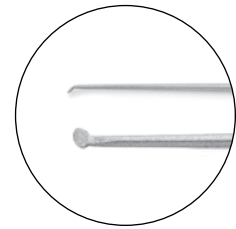

R8888

**Probe**

Catalog#	Description	Tip Length
R8880	90° Up, Bullet Tip	3mm

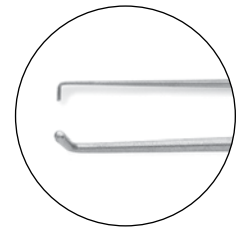

R8880



**Fukushima-Chen Cerebellar Pontine Tumor Bayonet Micro Instruments, Continued**  
7½" (191mm)

**Ring Currettes**

Catalog#	Description	Ring Diameter
R8882	60° Up	1.2mm
R8883	45° Up	1.5mm
R8884	45° Up	2mm

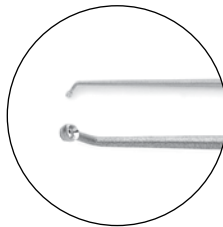

R8882

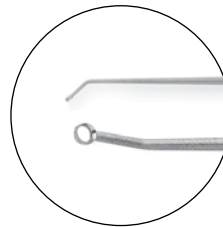

R8883

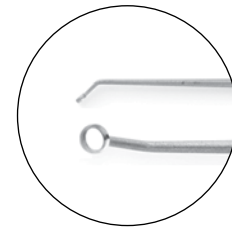

R8884

**Cup Currettes**

Catalog#	Description	Cup Size
R8885	Angled	1 x 1.5mm
R8886	Straight	1.5 x 2mm

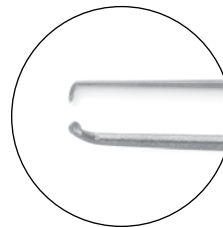

R8885

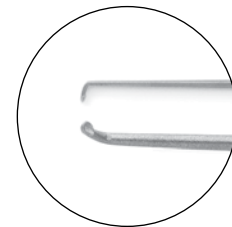

R8886

**Fukushima-Chen Cerebellar Pontine Tumor Bayonet Micro Instruments, Continued**  
7½" (191mm)

**Dissectors**

Catalog#	Description	Tip Width
<b>R8889</b>	45° Up, Sharp, Slightly Curve Up	1mm
<b>R8890</b>	45° Up, Sharp, Slightly Curve Up	2mm
<b>R8891</b>	45° Up, Sharp, 30° Duckbill Curve	1.5mm

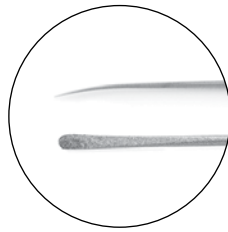

R8889

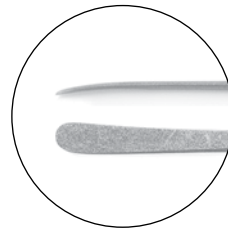

R8890

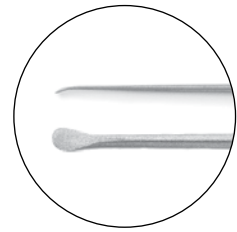

R8891



**Yasargil Micro Instruments**

7¼" (185mm) bayonet

Catalog#	Description	Working Length	Tip Width
RB9344	Arachnoid Knife	2¼" (57mm)	3mm
RB9345	Rasp, Slightly Curved	2¼" (57mm)	3mm
RB9346	Rasp, Backward Cutting	2¼" (57mm)	2mm
RB9347	Rasp, Forward Cutting	2¼" (57mm)	2mm
RB9348	Curette	2¼" (57mm)	2mm



RB9344



RB9345



RB9346



RB9347



RB9348

**Yasargil Micro Instruments, Continued**

7¼" (185mm) straight

Catalog#	Description	Tip	Tip Length	Tip Width
RB9339	Dissector, Round	Angled	6.7mm	3.2mm
RB9340	Rasp, Round	Slightly Curved	-	3mm
RB9341	Rasp, Round	Strongly Curved	-	3mm
RB9342	Rasp	Double Angled	8mm	1.4mm
RB9343	Dissector, Pointed	Double Angled	8.8mm	2.8mm



RB9339



RB9340



RB9341



RB9342



RB9343



**Titanium Dissection Instruments**

7¼" (180mm)

**Ligature Passer**

Catalog#	Tip Length
651301	3mm



**Nerve Hooks**

Catalog#	Description	Tip Length
651302	with Ball	3mm
651303	-	2mm
651304	-	3mm

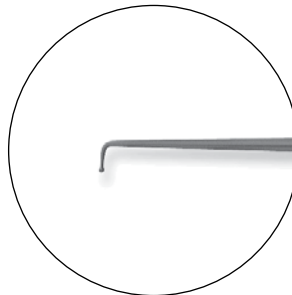

651302

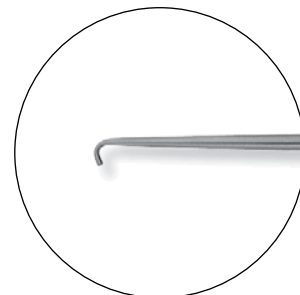

651303

**Vessel Supporter**

Catalog#	Tip Width
651305	2mm

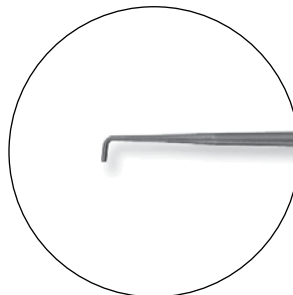

651304

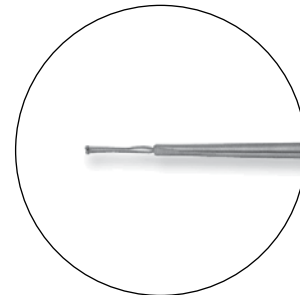

651305

**Titanium Dissector Instruments - continued**

7¼" (180mm)

**Dissector**

Catalog#	Description	Tip Length
651306	Angled, Curved Edge, Semi-Sharp	3.5mm



651306

**Bayonet Curette (not pictured)**

Catalog#	Cup Size
651307	2mm

**Titanium Elevators**

Catalog#	Description	Tip Width
651308	Curved	3.5mm
651309	Bayonet	3.5mm

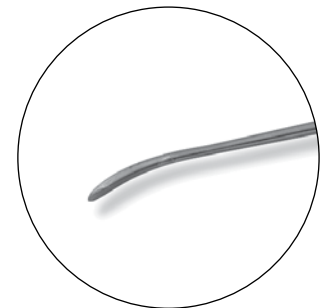

651308



**Titanium Dissector Instruments - continued**

7¼" (180mm)

**Dissector**

Catalog#	Description	Tip Width
651310	Angled, Sharp on 3 Sides	1mm

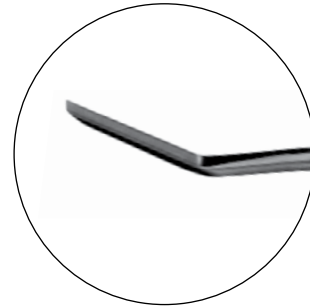

651310

**Round Dissectors**

Catalog#	Tip Width
651311	1mm
651312	2mm
651313	3.5mm

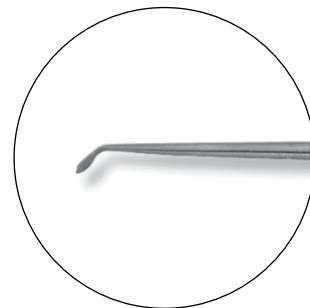

651312



**Krayenbuhl Hooks with Finger Rest**

Catalog#	Description	Length	Tip Length	Tip Diameter
RN8121	Small, Blunt Hook	7¼" (185mm)	2.7mm	-
RN8122	Large, Blunt Hook	7¼" (185mm)	3.7mm	-
RN8123	Small, Ball Tip	7¼" (185mm)	2.7mm	1mm
RN8124	Large, Ball Tip	7¼" (185mm)	3.7mm	1mm



RN8121

**Krayenbuhl Hooks without Finger Rest**

Catalog#	Description	Length	Tip Length
RN8125	Curved	7" (180mm)	2.7mm
RN8126	90° Angle	7" (180mm)	2.7mm



RN8126

**Krayenbuhl Twist Hooks without Finger Rest**

Catalog#	Description	Length	Tip Diameter
RN8127	Straight	7¼" (185mm)	1mm
RN8128	Straight	7¼" (185mm)	1.8mm



RN8128

### Weary Nerve Hooks

Catalog#	Description	Length	Tip Length
RNo127	Black Coated	7 <sup>3</sup> / <sub>4</sub> " (198mm)	3mm



### Dura Hooks

Catalog#	Description	Length	Tip Length
R8234	Regular	7 <sup>1</sup> / <sub>4</sub> " (184mm)	2.7mm
R8235	Delicate	7 <sup>1</sup> / <sub>4</sub> " (184mm)	2.7mm



R8234

**Microsurgical Bayonet Handle Instruments**  
9 1/2" (240mm)

**Nerve Hooks**

Catalog#	Description	Tip Length
R7305	90°, Angle	3mm
R7306	90°, Angle	4mm
R7307	90°, Angle	5mm
R7308	Tip Curved Up	5mm
R7309	Tip Curved Up	8mm
R7310	Tip Ball Point	3mm



**Hooks**

Catalog#	Description	Tip Length
R7315	Blunt	2mm
R7316	Blunt	2.5mm
R7317	Blunt	3mm
R7318	Semi-Sharp	2mm



**Microsurgical Bayonet Handle Instruments, Continued**  
9½" (240mm)

**Ligature Needles**

Catalog#	Description	Tip Length
R7320	Round Tip	3mm
R7321	Round Tip	5mm



R7321

**Micro Arachnoid Knife**

Catalog#	Description	Length	Tip Length
R8445	Curved Down	7¼" (184mm)	3mm



**Micro Forceps**  
round handle

Catalog#	Description	Length	Tip Size
RN8294	1 x 2 Delicate, Straight	7" (180mm)	.08 x 6.5mm



**Micro Tying Forceps**  
counterbalanced, round handle

Catalog#	Description	Length
RN8295	Tungsten Carbide Dust, Curved	8 1/4" (210mm)



**Micro Ring Forceps**  
counterbalanced, round handle

Catalog#	Description	Length	Tip Width
RN0188	Straight	8 1/4" (210mm)	1.1mm (OD)
RN0189	Straight	9" (229mm)	1.3mm (OD)



RN0188

**Micro Forceps with Catch**  
flat handle

Catalog#	Description	Length	Tip Size
R8230	Strongly Curved Jaws	7" (180mm)	1 x 15mm
R8231	Slightly Curved Jaws	7" (180mm)	1 x 18mm



R8230

**Yasargil Forceps**  
flat bayonet handle

Catalog#	Description	Length	Tip Width
R8250	Straight, Normal	9" (229mm)	0.8mm
R8251	Straight, Extra Fine	9" (229mm)	0.3mm



R8251



### Titanium Forceps

Catalog#	Description	Length	Teeth
RB1150T	Adson	4¾" (121mm)	Serrated
RB1154T	Adson	4¾" (121mm)	1 x 2
RB1174T	Cushing, w/Gutsch Handle	7" (177mm)	Serrated
RB1175T	Cushing, w/Gutsch Handle	7" (178mm)	1 x 2



RB1174T

### DeBakey Forceps

round handle

Catalog#	Description	Length	Tip Size
RB9187	Delicate	7¼" (184mm)	1.2 x 20mm
RB9188	Delicate	8¼" (210mm)	1.2 x 20mm



RB9187

### McCravey Tissue Forceps

Catalog#	Length	Jaw Width
RO455	7" (178mm)	6.5mm

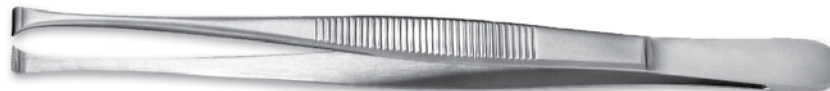

### Adson Bayonet Forceps

Catalog#	Length	Tip Size
RO462	7" (180mm)	2 x 20mm



### Yasargil Bayonet Forceps

Catalog#	Length	Tip Width
RB9137	7" (178mm)	0.6mm
RB9138	7" (178mm)	0.9mm
RB9139	7" (178mm)	1 x 2 tip
RB9140	7 <sup>3</sup> / <sub>4</sub> " (200mm)	0.6mm
RB9141	7 <sup>3</sup> / <sub>4</sub> " (200mm)	0.9mm
RB9142	8 <sup>3</sup> / <sub>4</sub> " (220mm)	0.6mm
RB9143	8 <sup>3</sup> / <sub>4</sub> " (220mm)	0.9mm
RB9144	9 <sup>1</sup> / <sub>2</sub> " (241mm)	0.6mm
RB9145	9 <sup>1</sup> / <sub>2</sub> " (241mm)	0.9mm



RB9137

### Potts-Smith Dressing Forceps with Tungsten-Carbide Inserts flat handle

Catalog#	Length	Tip
RO439	7 <sup>1</sup> / <sub>4</sub> " (184mm)	2 x 14mm



### Gerald Forceps flat handle

Catalog#	Description	Length	Teeth	Tip Size
RO435	Straight	7" (176mm)	Tissue, 1 x 2	1.3 x 26mm
RO437	Straight	7" (175mm)	Dressing	1.3 x 26mm
RO440	Curved	7" (176mm)	Tissue, 1 x 2	-
RO442	Curved	7" (175mm)	Dressing	-



RO437

**Yasargil Bayonet Forceps**  
flat handle

Catalog#	Description	Length	Tip Width
RN8032	Sharp	7¼" (184mm)	0.3mm
RN8033	Blunt	7¼" (184mm)	0.8mm
RN8030	Sharp	8¼" (210mm)	0.3mm
RN8031	Blunt	8¼" (210mm)	0.8mm
RN8029	Sharp	9" (229mm)	0.3mm
RN8028	Blunt	9" (229mm)	0.8mm



RN8030

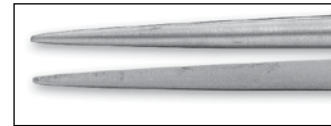

Blunt

**Yasargil Bayonet Tumor Forceps**  
flat handle

Catalog#	Description	Length	Tip Width
RN8034	Spoon Shaped	9" (229mm)	3.0mm
RN8036	Serrated Flat	9" (229mm)	3.0mm



RN8034



**Semken Forceps with Tungsten-Carbide Inserts**  
flat handle

Catalog#	Length	Description
RT0145	6" (154mm)	1 x 2
RT0146	5⅞" (149mm)	Serrated



RT0145



**Iris Bipolar Forceps**

Catalog#	Description	Length	Tip Width
R2645	Straight	3½" (90mm)	0.3mm
R2646	Curved	3½" (90mm)	0.3mm



R2646

**Semken Bipolar Forceps**

Catalog#	Length	Tip Width
R2640	5¾" (135mm)	0.7mm



**Adson Bipolar Forceps**

Catalog#	Length	Tip Width
RB9221	4¾" (120mm)	1mm



**Jeweler's Bipolar Forceps**

Catalog#	Length	Tip Width
RB9222	4½" (115mm)	0.2mm



**Cushing Bipolar Forceps**

Catalog#	Length	Tip Width
RB9224	6" (152mm)	0.7mm



**Microsurgical Bipolar Bayonet Forceps**

Catalog#	Description	Length	Tip Width
R2620	40° Down	7¼" (184mm)	0.6mm
R2696	Straight	7¼" (184mm)	0.6mm



R2696

**Transphenoidal Hypophysectomy Bipolar Bayonet Forceps**

Catalog#	Description	Length	Tip Width
R2697	Straight	8½" (216mm)	0.7mm
R2698	Straight, Insulated	8½" (216mm)	0.7mm



R2698

**Gerald Bipolar Bayonet Forceps**

Catalog#	Length	Tip Width
RB9227	7" (178mm)	1mm



**Rhoton Bipolar Bayonet Forceps**

Catalog#	Length	Tip Width
RB9243	8½" (216mm)	1mm



**Hardy Style Bipolar Bayonet Forceps**

Catalog#	Description	Length	Tip Width
RR2201	Irrigated, Insulated, Straight	8½" (215mm)	0.2mm
RR2202	Irrigated, Insulated, Straight	8½" (215mm)	0.4mm
RR2203	Irrigated, Insulated, Straight	8½" (215mm)	0.5mm
RR2204	Irrigated, Insulated, Straight	8½" (215mm)	0.7mm
RR2205	Irrigated, Insulated, Straight	8½" (215mm)	1mm
RR2206	Irrigated, Insulated, Straight	8½" (215mm)	1.3mm
RR2207	Irrigated, Insulated, Straight	8½" (215mm)	1.5mm
RR2208	Irrigated, Insulated, Straight	8½" (215mm)	1.7mm
RR2209	Irrigated, Insulated, Straight	8½" (215mm)	2mm
RR2301	Irrigated, Insulated, 45° Angle Down	8¼" (212mm)	0.2mm
RR2302	Irrigated, Insulated, 45° Angle Down	8¼" (212mm)	0.4mm
RR2303	Irrigated, Insulated, 45° Angle Down	8¼" (212mm)	0.5mm
RR2304	Irrigated, Insulated, 45° Angle Down	8¼" (212mm)	0.7mm
RR2305	Irrigated, Insulated, 45° Angle Down	8¼" (212mm)	1mm
RR2306	Irrigated, Insulated, 45° Angle Down	8¼" (212mm)	1.3mm
RR2307	Irrigated, Insulated, 45° Angle Down	8¼" (212mm)	1.5mm
RR2308	Irrigated, Insulated, 45° Angle Down	8¼" (212mm)	1.7mm
RR2309	Irrigated, Insulated, 45° Angle Down	8¼" (212mm)	2mm
RR2401	Irrigated, Insulated, 45° Angle Up	8¼" (212mm)	0.2mm
RR2402	Irrigated, Insulated, 45° Angle Up	8¼" (212mm)	0.4mm
RR2403	Irrigated, Insulated, 45° Angle Up	8¼" (212mm)	0.5mm
RR2404	Irrigated, Insulated, 45° Angle Up	8¼" (212mm)	0.7mm
RR2405	Irrigated, Insulated, 45° Angle Up	8¼" (212mm)	1mm
RR2406	Irrigated, Insulated, 45° Angle Up	8¼" (212mm)	1.3mm
RR2407	Irrigated, Insulated, 45° Angle Up	8¼" (212mm)	1.5mm
RR2408	Irrigated, Insulated, 45° Angle Up	8¼" (212mm)	1.7mm
RR2409	Irrigated, Insulated, 45° Angle Up	8¼" (212mm)	2mm
RR2501	Insulated, Straight	8½" (215mm)	0.2mm
RR2502	Insulated, Straight	8½" (215mm)	0.4mm
RR2503	Insulated, Straight	8½" (215mm)	0.5mm
RR2504	Insulated, Straight	8½" (215mm)	0.7mm
RR2505	Insulated, Straight	8½" (215mm)	1mm
RR2506	Insulated, Straight	8½" (215mm)	1.3mm
RR2507	Insulated, Straight	8½" (215mm)	1.5mm
RR2508	Insulated, Straight	8½" (215mm)	1.7mm
RR2509	Insulated, Straight	8½" (215mm)	2mm
RB9233	Uninsulated, Straight	8¼" (210mm)	0.7mm

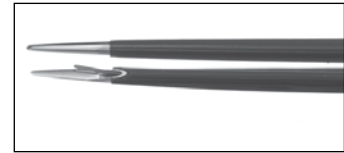

Straight



Angle Down



Angle Up



RR2204



**Scoville-Greenwod Style Bipolar Bayonet Forceps**

Catalog#	Description	Length	Tip Width
RR2601	Insulated, Straight	7¾" (197mm)	0.2mm
RR2602	Insulated, Straight	7¾" (197mm)	0.4mm
RR2603	Insulated, Straight	7¾" (197mm)	0.5mm
RR2604	Insulated, Straight	7¾" (197mm)	0.7mm
RR2605	Insulated, Straight	7¾" (197mm)	1mm
RR2606	Insulated, Straight	7¾" (197mm)	1.3mm
RR2607	Insulated, Straight	7¾" (197mm)	1.5mm
RR2608	Insulated, Straight	7¾" (197mm)	1.7mm
RR2609	Insulated, Straight	7¾" (197mm)	2mm
RB9235	Uninsulated, Straight	7¼" (184mm)	1.5mm
RB9236	Insulated, Irrigated, Straight	7¼" (184mm)	1.5mm



RR2605

**Yasargil Style Bipolar Bayonet Forceps**

Catalog#	Description	Length	Tip Width
RR2701	Irrigated, Straight	6" (154mm)	0.5mm
RR2702	Irrigated, Straight	6" (154mm)	0.7mm
RR2703	Irrigated, Straight	6" (154mm)	1mm
RR2704	Irrigated, Straight	6" (154mm)	1.3mm
RR2705	Irrigated, Straight	7⅛" (181mm)	0.5mm
RR2706	Irrigated, Straight	7⅛" (181mm)	0.7mm
RR2707	Irrigated, Straight	7⅛" (181mm)	1mm
RR2708	Irrigated, Straight	7⅛" (181mm)	1.3mm
RR2709	Irrigated, Straight	7⅞" (200mm)	0.5mm
RR2710	Irrigated, Straight	7⅞" (200mm)	0.7mm
RR2711	Irrigated, Straight	7⅞" (200mm)	1mm
RR2712	Irrigated, Straight	7⅞" (200mm)	1.3mm
RB9241	Insulated, Straight	7⅞" (200mm)	1mm
RB9242	Insulated, Straight	7⅞" (200mm)	2mm



RR2711

**Titanium Bipolar Bayonet Forceps, Irrigated**

Catalog#	Description	Length	Tip Width
RR2804	Irrigated, Insulated, Straight	8¾" (225mm)	0.2mm
RR2805	Irrigated, Insulated, Straight	8¾" (225mm)	0.4mm
RR2806	Irrigated, Insulated, Straight	8¾" (225mm)	0.5mm
RR2807	Irrigated, Insulated, Straight	8¾" (225mm)	0.7mm
RR2808	Irrigated, Insulated, Straight	8¾" (225mm)	1mm
RR2809	Irrigated, Insulated, Straight	8¾" (225mm)	1.3mm
RR2810	Irrigated, Insulated, Straight	8¾" (225mm)	1.5mm
RR2811	Irrigated, Insulated, Straight	8¾" (225mm)	1.7mm
RR2812	Irrigated, Insulated, Straight	8¾" (225mm)	2mm



RR2810



**Titanium Bipolar Bayonet Forceps**

Catalog#	Description	Length	Tip Width
R2691	Straight	8¾" (222mm)	1.5mm
R2692	Straight	8¾" (222mm)	0.5mm
R2693	Straight	8¾" (222mm)	1mm
R2694	Angled Up	8¾" (222mm)	0.5mm



R2693



### Apfelbaum Bipolar Bayonet Forceps

Catalog#	Description	Length	Tip Width
RN1121	Titanium, Straight	8¾" (222mm)	0.7mm
RN1122	Titanium, Straight	8¾" (222mm)	1mm
RN1123	Titanium, Angled Up	8¾" (222mm)	0.7mm
RN1124	Titanium, Angled Up	8¾" (222mm)	1mm
RN1125	Titanium, Angled Down	8¾" (222mm)	0.7mm
RN1126	Titanium, Angled Down	8¾" (222mm)	1mm
RN1127	Titanium, Straight	10" (254mm)	0.7mm
RN1128	Titanium, Angled Up	10" (254mm)	0.7mm
RN1129	Titanium, Angled Down	10" (254mm)	0.7mm
RN1127N	Insulated, Straight	10" (254mm)	0.7mm
RN1128N	Insulated, Angled Up	10" (254mm)	0.7mm
RN1129N	Insulated, Angled Down	10" (254mm)	0.7mm

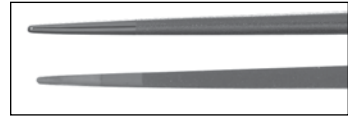

Straight

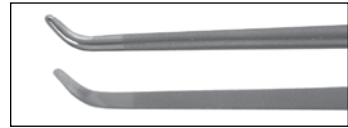

Up

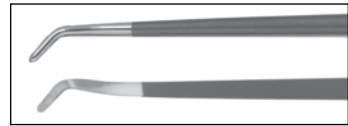

Down

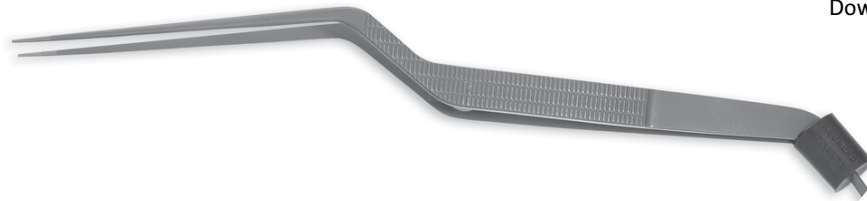

RN1121

### Apfelbaum Bipolar Forceps Tray

Instruments Not Included

Catalog#	Description
RS1120	Single Level Holds RN1121 through RN1129N 14½" L x 11½" W x 1½" D



**Malis-Style Bipolar Bayonet Forceps**

Catalog#	Description	Length	Tip Width
RB9228	Non-Insulated	7 <sup>3</sup> / <sub>4</sub> " (197mm)	1.5mm
RB9229	Insulated, Irrigated	8 <sup>1</sup> / <sub>2</sub> " (215mm)	0.7mm
RB9230	Insulated, Irrigated	8 <sup>3</sup> / <sub>4</sub> " (222mm)	1mm
RB9231	Non-Insulated	7" (178mm)	1.5mm



RB9228



RB9229

**Malis-Style Jensen Bipolar Bayonet Forceps**

Catalog#	Length	Tip Width
RB9232	7 <sup>3</sup> / <sub>4</sub> " (197mm)	0.15mm



**BUZZ™ Non-stick Bayonet Bipolar Forceps, Insulated**

Catalog #	Description	Length	Working Length	Tip Width
N15BS03	w/stop	5 <sup>3</sup> / <sub>8</sub> " (138mm)	2" (52mm)	0.3mm
N15BS06	w/stop	5 <sup>3</sup> / <sub>8</sub> " (138mm)	2" (52mm)	0.6mm
N15BS10	w/stop	5 <sup>3</sup> / <sub>8</sub> " (138mm)	2" (52mm)	1mm
N15BS20	w/stop	5 <sup>3</sup> / <sub>8</sub> " (138mm)	2" (52mm)	2mm
N18BS03	w/stop	6 <sup>1</sup> / <sub>2</sub> " (168mm)	3 <sup>1</sup> / <sub>4</sub> " (83mm)	0.3mm
N18BS06	w/stop	6 <sup>1</sup> / <sub>2</sub> " (168mm)	3 <sup>1</sup> / <sub>4</sub> " (83mm)	0.6mm
N18BS10	w/stop	6 <sup>1</sup> / <sub>2</sub> " (168mm)	3 <sup>1</sup> / <sub>4</sub> " (83mm)	1mm
N18BS20	w/stop	6 <sup>1</sup> / <sub>2</sub> " (168mm)	3 <sup>1</sup> / <sub>4</sub> " (83mm)	2mm
N20BS03	w/stop	7 <sup>1</sup> / <sub>4</sub> " (186mm)	3 <sup>7</sup> / <sub>8</sub> " (98mm)	0.3mm
N20BS06	w/stop	7 <sup>1</sup> / <sub>4</sub> " (186mm)	3 <sup>7</sup> / <sub>8</sub> " (98mm)	0.6mm
N20BS10	w/stop	7 <sup>1</sup> / <sub>4</sub> " (186mm)	3 <sup>7</sup> / <sub>8</sub> " (98mm)	1mm
N20BS20	w/stop	7 <sup>1</sup> / <sub>4</sub> " (186mm)	3 <sup>7</sup> / <sub>8</sub> " (98mm)	2mm
N22BS03	w/stop	8" (206mm)	4 <sup>5</sup> / <sub>8</sub> " (118mm)	0.3mm
N22BS06	w/stop	8" (206mm)	4 <sup>5</sup> / <sub>8</sub> " (118mm)	0.6mm
N22BS10	w/stop	8" (206mm)	4 <sup>5</sup> / <sub>8</sub> " (118mm)	1mm
N22BS15	w/stop	8" (206mm)	4 <sup>5</sup> / <sub>8</sub> " (118mm)	1.5mm
N22BS20	w/stop	8" (206mm)	4 <sup>5</sup> / <sub>8</sub> " (118mm)	2mm
N24BS03	w/stop	8 <sup>3</sup> / <sub>4</sub> " (225mm)	5 <sup>3</sup> / <sub>8</sub> " (138mm)	0.3mm
N24BS06	w/stop	8 <sup>3</sup> / <sub>4</sub> " (225mm)	5 <sup>3</sup> / <sub>8</sub> " (138mm)	0.6mm
N24BS10	w/stop	8 <sup>3</sup> / <sub>4</sub> " (225mm)	5 <sup>3</sup> / <sub>8</sub> " (138mm)	1mm
N24BS20	w/stop	8 <sup>3</sup> / <sub>4</sub> " (225mm)	5 <sup>3</sup> / <sub>8</sub> " (138mm)	2mm
N20BAU10	w/stop, 45° angled up tip	7 <sup>1</sup> / <sub>4</sub> " (182mm)	3 <sup>7</sup> / <sub>8</sub> " (98mm)	1mm
N20BAD10	w/stop, 45° angled down tip	7 <sup>1</sup> / <sub>4</sub> " (182mm)	3 <sup>7</sup> / <sub>8</sub> " (98mm)	1mm
N22BAU10	w/stop, 45° angled up tip	8" (204mm)	4 <sup>5</sup> / <sub>8</sub> " (117mm)	1mm
N22BAD10	w/stop, 45° angled down tip	8" (204mm)	4 <sup>5</sup> / <sub>8</sub> " (117mm)	1mm
NI15BS10	Irrigated, w/stop	5 <sup>3</sup> / <sub>8</sub> " (138mm)	2" (52mm)	1mm
NI18BS06	Irrigated, w/stop	6 <sup>1</sup> / <sub>2</sub> " (168mm)	3 <sup>1</sup> / <sub>4</sub> " (83mm)	0.6mm
NI18BS10	Irrigated, w/stop	6 <sup>1</sup> / <sub>2</sub> " (168mm)	3 <sup>1</sup> / <sub>4</sub> " (83mm)	1mm
NI22BS06	Irrigated, w/stop	8" (206mm)	4 <sup>5</sup> / <sub>8</sub> " (118mm)	0.6mm
NI22BS10	Irrigated, w/stop	8" (206mm)	4 <sup>5</sup> / <sub>8</sub> " (118mm)	1mm
NI22BS20	Irrigated, w/stop	8" (206mm)	4 <sup>5</sup> / <sub>8</sub> " (118mm)	2mm



N20BS10



**BUZZ Non-stick Cushing Bipolar Forceps, Insulated**

Catalog #	Description	Length	Working Length	Tip Width
N19Co7	-	7½" (193mm)	3⅜" (85mm)	0.7mm
N19C12	-	7½" (193mm)	3⅜" (85mm)	1.2mm
N19C15	-	7½" (193mm)	3⅜" (85mm)	1.5mm
NI19Co7	Irrigated	7½" (193mm)	3⅜" (85mm)	0.7mm
NI19C12	Irrigated	7½" (193mm)	3⅜" (85mm)	1.2mm
NI19C15	Irrigated	7½" (193mm)	3⅜" (85mm)	1.5mm



N19C15

**BUZZ Non-stick Scoville-Greenwood Bipolar Forceps, Insulated**

Catalog #	Description	Length	Working Length	Tip Width
N2oSGo3	-	7½" (193mm)	3⅜" (85mm)	.03mm
N2oSG15	-	7¾" (198mm)	2⅝" (68mm)	1.5mm
NI2oSG10	Irrigated	7¾" (198mm)	2⅝" (68mm)	1mm
NI2oSG15	Irrigated	7¾" (198mm)	2⅝" (68mm)	1.5mm
NI2oSG20	Irrigated	7¾" (198mm)	2⅝" (68mm)	2mm



N2oSG15



**BUZZ Non-stick Hardy Bipolar Forceps, Insulated**

Catalog #	Description	Length	Working Length	Tip Width
NH02	w/stop	8½" (216mm)	4¾" (112mm)	0.2mm
NH04	w/stop	8½" (216mm)	4¾" (112mm)	0.4mm
NH05	w/stop	8½" (216mm)	4¾" (112mm)	0.5mm
NH07	w/stop	8½" (216mm)	4¾" (112mm)	0.7mm
NH10	w/stop	8½" (216mm)	4¾" (112mm)	1mm
NH13	w/stop	8½" (216mm)	4¾" (112mm)	1.3mm
NH15	w/stop	8½" (216mm)	4¾" (112mm)	1.5mm
NH17	w/stop	8½" (216mm)	4¾" (112mm)	1.7mm
NH20	w/stop	8½" (216mm)	4¾" (112mm)	2mm
NHAD02	w/stop, 45° angle down tip	8½" (216mm)	4¾" (112mm)	0.2mm
NHAD04	w/stop, 45° angle down tip	8½" (216mm)	4¾" (112mm)	0.4mm
NHAD05	w/stop, 45° angle down tip	8½" (216mm)	4¾" (112mm)	0.5mm
NHAD07	w/stop, 45° angle down tip	8½" (216mm)	4¾" (112mm)	0.7mm
NHAD10	w/stop, 45° angle down tip	8½" (216mm)	4¾" (112mm)	1mm
NHAD13	w/stop, 45° angle down tip	8½" (216mm)	4¾" (112mm)	1.3mm
NHAD15	w/stop, 45° angle down tip	8½" (216mm)	4¾" (112mm)	1.5mm
NHAD17	w/stop, 45° angle down tip	8½" (216mm)	4¾" (112mm)	1.7mm
NHAD20	w/stop, 45° angle down tip	8½" (216mm)	4¾" (112mm)	2mm
NHAU02	w/stop, 45° angle up tip	8½" (216mm)	4¾" (112mm)	0.2mm
NHAU04	w/stop, 45° angle up tip	8½" (216mm)	4¾" (112mm)	0.4mm
NHAU05	w/stop, 45° angle up tip	8½" (216mm)	4¾" (112mm)	0.5mm
NHAU07	w/stop, 45° angle up tip	8½" (216mm)	4¾" (112mm)	0.7mm
NHAU10	w/stop, 45° angle up tip	8½" (216mm)	4¾" (112mm)	1mm
NHAU13	w/stop, 45° angle up tip	8½" (216mm)	4¾" (112mm)	1.3mm
NHAU15	w/stop, 45° angle up tip	8½" (216mm)	4¾" (112mm)	1.5mm
NHAU17	w/stop, 45° angle up tip	8½" (216mm)	4¾" (112mm)	1.7mm
NHAU20	w/stop, 45° angle up tip	8½" (216mm)	4¾" (112mm)	2mm
NHI10	Irrigated, w/stop	8½" (216mm)	4¾" (112mm)	1mm
NHI15	Irrigated, w/stop	8½" (216mm)	4¾" (112mm)	1.5mm



NH10

**BUZZ Non-stick Jeweler Bipolar Forceps, Insulated**

Catalog #	Length	Tip Width
N11J025	4½" (113mm)	0.25mm
N11J06	4½" (113mm)	0.6mm
N11J10	4½" (113mm)	1mm



N11J10

**BUZZ Non-stick Adson Bipolar Forceps, Insulated**

Catalog #	Length	Tip Width
N125A07	5¼" (132mm)	0.7mm
N125A12	5¼" (132mm)	1.2mm

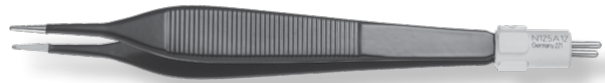

N125A12

**BUZZ Non-stick Semken Bipolar Forceps, Insulated**

Catalog #	Length	Tip Width
N15S12	6¼" (156mm)	1.2mm



**BUZZ Non-stick Straight Bipolar Forceps, Insulated**

Catalog #	Description	Length	Tip Width
N15S03	w/stop	5 <sup>3</sup> / <sub>8</sub> " (137mm)	0.3mm
N15S06	w/stop	5 <sup>3</sup> / <sub>8</sub> " (137mm)	0.6mm
N15S10	w/stop	5 <sup>3</sup> / <sub>8</sub> " (137mm)	1mm
N15S20	w/stop	5 <sup>3</sup> / <sub>8</sub> " (137mm)	2mm
N18S03	w/stop	6 <sup>1</sup> / <sub>2</sub> " (167mm)	0.3mm
N18S06	w/stop	6 <sup>1</sup> / <sub>2</sub> " (167mm)	0.6 mm
N18S10	w/stop	6 <sup>1</sup> / <sub>2</sub> " (167mm)	1mm
N20S03	w/stop	7 <sup>1</sup> / <sub>4</sub> " (185mm)	0.3mm
N20S10	w/stop	7 <sup>1</sup> / <sub>4</sub> " (185mm)	1mm
N20S20	w/stop	7 <sup>1</sup> / <sub>4</sub> " (185mm)	2mm
N22S03	w/stop	8 <sup>1</sup> / <sub>4</sub> " (207mm)	0.3mm
N22S10	w/stop	8 <sup>1</sup> / <sub>4</sub> " (207mm)	1mm
N22S20	w/stop	8 <sup>1</sup> / <sub>4</sub> " (207mm)	2mm
N15SA03	w/stop, angled tip	5 <sup>3</sup> / <sub>8</sub> " (135mm)	0.3mm
N15SA10	w/stop, angled tip	5 <sup>3</sup> / <sub>8</sub> " (135mm)	1mm
N15SA20	w/stop, angled tip	5 <sup>3</sup> / <sub>8</sub> " (135mm)	2mm
N18SA03	w/stop, angled tip	6 <sup>1</sup> / <sub>4</sub> " (160mm)	0.3mm
N18SA06	w/stop, angled tip	6 <sup>1</sup> / <sub>4</sub> " (160mm)	0.6mm
N18SA10	w/stop, angled tip	6 <sup>1</sup> / <sub>4</sub> " (160mm)	1mm
N20SA03	w/stop, angled tip	7 <sup>1</sup> / <sub>4</sub> " (183mm)	0.3mm
N20SA10	w/stop, angled tip	7 <sup>1</sup> / <sub>4</sub> " (183mm)	1mm
N20SA20	w/stop, angled tip	7 <sup>1</sup> / <sub>4</sub> " (183mm)	2mm
N22SA03	w/stop, angled tip	8" (205mm)	0.3mm
N22SA10	w/stop, angled tip	8" (205mm)	1mm
N22SA20	w/stop, angled tip	8" (205mm)	2mm



N15S10

**BUZZ Lite™ Non-stick Bayonet Bipolar Forceps, Insulated**

Catalog #	Description	Length	Working Length	Tip Width
N10BL03	w/stop	7½" (190mm)	3⅞" (100mm)	0.3mm
N10BL06	w/stop	7½" (190mm)	3⅞" (100mm)	0.6mm
N10BL13	w/stop	7½" (190mm)	3⅞" (100mm)	1.3mm
N10BL17	w/stop	7½" (190mm)	3⅞" (100mm)	1.7mm
N13BLA15	w/stop, 15° angled up tip	8¾" (220mm)	5⅞" (130mm)	0.6mm
N13BLA30	w/stop, 30° angled up tip	8¾" (220mm)	5⅞" (130mm)	0.6mm
N13BLA45	w/stop, 45° angled up tip	8¾" (220mm)	5⅞" (130mm)	0.6mm
N13BL03	w/stop	8¾" (220mm)	5⅞" (130mm)	0.3mm
N13BL06	w/stop	8¾" (220mm)	5⅞" (130mm)	0.6mm
N13BL13	w/stop	8¾" (220mm)	5⅞" (130mm)	1.3mm
N13BL17	w/stop	8¾" (220mm)	5⅞" (130mm)	1.7mm
N15BL03	w/stop	9½" (240mm)	5⅞" (150mm)	0.3mm
N15BL06	w/stop	9½" (240mm)	5⅞" (150mm)	0.6mm
N15BL13	w/stop	9½" (240mm)	5⅞" (150mm)	1.3mm
N15BL17	w/stop	9½" (240mm)	5⅞" (150mm)	1.7mm
N17BL03	w/stop	10¼" (255mm)	6¾" (170mm)	0.3mm
N17BL06	w/stop	10¼" (255mm)	6¾" (170mm)	0.6mm
N17BL13	w/stop	10¼" (255mm)	6¾" (170mm)	1.3mm
N17BL17	w/stop	10¼" (255mm)	6¾" (170mm)	1.7mm



N10BL06

**BUZZ Accessories**

Catalog #	Description
NRBC118	Reusable bipolar forceps cord 118" (3.0m) (2 pin connector)
NBT35	Tray, fits up to 5 Forceps
NBT10	Tray, fits up to 10 Forceps
NBCLOTH	Polishing Cloth
BUZZSTYLET	Stylet for BUZZ Irrigating Bipolar Forceps

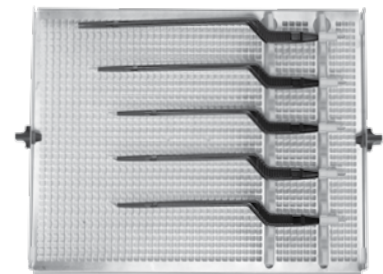

NBT10

**Micro Scissors**

round handle

Catalog#	Description	Length	Blade Length
RN6240	Straight	7" (180mm)	10mm
RN6241	Curved	7" (180mm)	10mm
RN8060	Straight, Long	7" (180mm)	14mm
RN8061	Curved, Long	7" (180mm)	14mm



RN8060

**Jacobson Scissors**

flat handle

Catalog#	Description	Length	Blade Length
RN8142	Straight	7" (184mm)	15mm
RN8143	Curved	7" (184mm)	15mm
RN8144	Angled	7" (184mm)	15mm



RN8142

**Rhoton-Style Micro Scissors**  
round handle

Catalog#	Description	Length	Blade Length
RB9022	Straight	7" (178mm)	13.5mm
RB9023	Curved	7" (178mm)	13.5mm



RB9022

**Evandro De Oliveira Micro Scissors**  
round handle

Catalog#	Description	Length	Blade Length
RB9006	Straight	6" (152mm)	9mm
RB9008	Straight	8" (203mm)	9mm
RB9010	Straight	7" (108mm)	9mm
RB9011	Curved	7" (178mm)	9mm

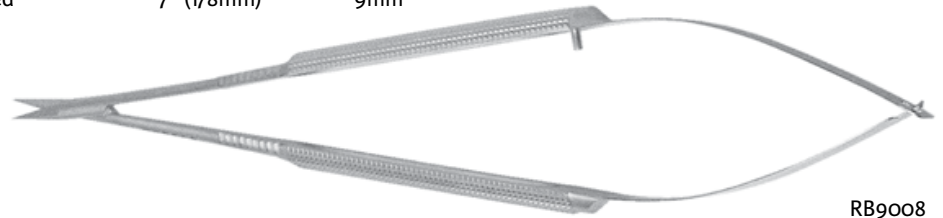

RB9008

**Yasargil Scissors**  
flat handle

Catalog#	Description	Length	Blade Length
RB8951	Straight	6¼" (159mm)	14mm
RB8952	Curved	6¼" (159mm)	14mm

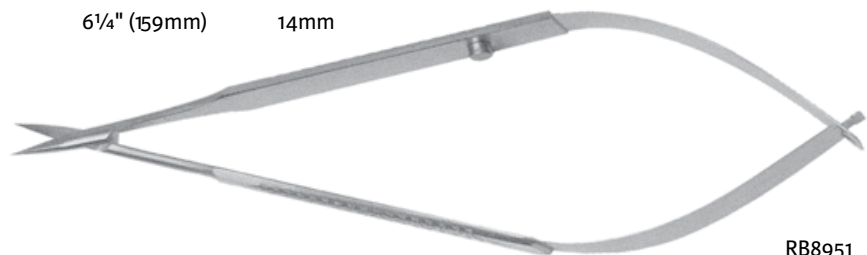

RB8951

**Nagel Micro Scissors**

Catalog#	Description	Length
RB9129	45° Lateral Angle	8" (203mm)



**Micro Bayonet Scissors**  
round handle

Catalog#	Description	Length
RN6253	Straight	8¾" (222mm)
RN6254	Curved	8¾" (222mm)
RN6255	Straight	9¼" (235mm)
RN6256	Curved	9¼" (235mm)
RN8065	Straight	8¼" (210mm)
RN8066	Curved	8¼" (210mm)



RN6254

**Jacobson Micro Bayonet Scissors**  
flat handle

Catalog#	Description	Length	Blade Length
RN8145	Straight	7¼" (185mm)	13mm
RN8146	Curved	7¼" (185mm)	13mm
RN8147	Angled	7¼" (185mm)	13mm
RN8148	Micro Straight	7¼" (185mm)	10mm
RN8149	Micro Curved	7¼" (185mm)	10mm



RN8148

**Yasargil Micro Bayonet Scissors**  
flat handle

Catalog#	Description	Length	Blade Length
RN8020	Straight	8¾" (222mm)	14mm
RN8021	Curved	8¾" (222mm)	14mm
RN8022	Micro Straight	9" (229mm)	7.5mm
RN8023	Micro Curved	9" (229mm)	7.5mm



RN8022



**Yasargil Micro Bayonet Scissors**  
flat handle

Catalog#	Description	Length
RB9110	Straight	6 <sup>3</sup> / <sub>4</sub> " (165mm)
RB9111	Curved Up	6 <sup>3</sup> / <sub>4</sub> " (165mm)
RB9112	Straight, Dissecting	6 <sup>1</sup> / <sub>2</sub> " (165mm)
RB9113	Straight, Dissecting	7 <sup>1</sup> / <sub>2</sub> " (190mm)
RB9114	Straight, Serrated	8 <sup>1</sup> / <sub>4</sub> " (210mm)
RB9115	Curved Up, Serrated	8 <sup>1</sup> / <sub>4</sub> " (210mm)
RB9116	Curved Down, Serrated	8 <sup>1</sup> / <sub>4</sub> " (210mm)
RB9120	Straight	9" (230mm)
RB9121	Curved	9" (230mm)
RB9122	Curved Up	9" (230mm)
RB9124	Curved, Micro Tip	9" (230mm)
RB9123	Straight, Micro Tip	9" (230mm)
RB9125	Straight, Dissecting	9" (230mm)
RB9126	Curved, Dissecting	9" (230mm)
RB9127	45° Lateral Angle, with Ball	8" (203mm)
RB9128	125° Lateral Angle	7 <sup>1</sup> / <sub>2</sub> " (191mm)

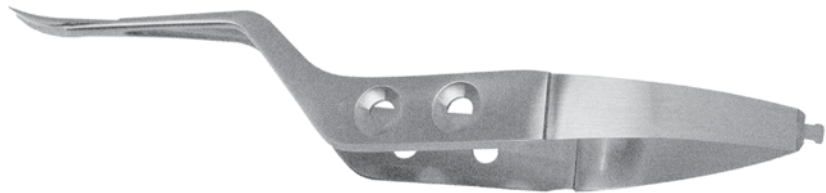

RB9115



RB9127

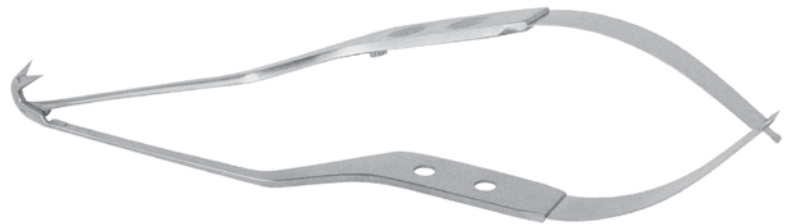

RB9128

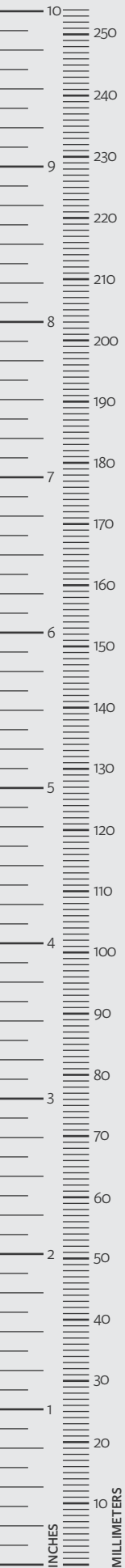

**Micro Bayonet Scissors, Serrated Blade**

**Sharp, Flat Handle**

Catalog#	Description	Length
RN8001	Straight	9¼" (234mm)
RN8002	Up	9¼" (234mm)
RN8003	Down	9¼" (234mm)
RN8004	Straight	10½" (267mm)
RN8005	Up	10½" (267mm)
RN8006	Straight	8¼" (210mm)
RN8007	Up	8¼" (210mm)
RN8008	Straight	7¼" (184mm)
RN8009	Up	7¼" (184mm)



Straight



Up



Down



RN8001

**Blunt, Flat Handle**

Catalog#	Description	Length
RN8001B	Straight	9¼" (234mm)
RN8002B	Up	9¼" (234mm)
RN8003B	Down	9¼" (234mm)
RN8004B	Straight	10½" (267mm)
RN8005B	Up	10½" (267mm)
RN8006B	Straight	8¼" (210mm)
RN8007B	Up	8¼" (210mm)
RN8008B	Straight	7¼" (184mm)
RN8009B	Up	7¼" (184mm)

**Micro Bayonet Scissors -Tray**

Instruments Not Included

Catalog#	Description
RS8000	Holds RN8001 through RN8009 Holds RN8001B through RN8009B

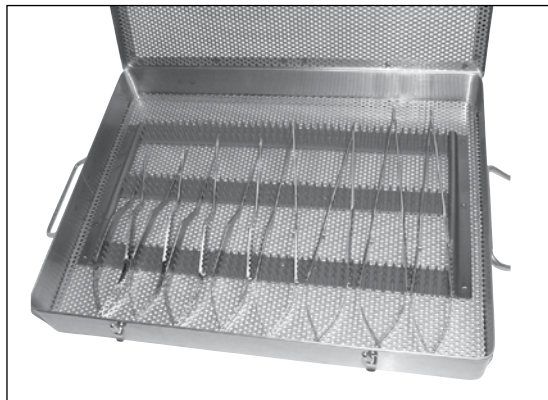

**Fukushima-Giannotta Micro Bayonet Scissors**  
flat handle



Catalog#	Description	Length	R8924
R8924	Straight, Long, Blunt	8" (205mm)	
R8925	Straight	7 1/4" (180mm)	
R8926	Curved Up	7 1/4" (185mm)	
R8927	Straight	8" (205mm)	
R8928	Curved Up	8" (205mm)	
R8929	Straight	8 3/4" (220mm)	
R8930	Curved Up	8 3/4" (220mm)	
R8931	Curved Up, Very Fine	8" (203mm)	
R8931S	Curved Up, Very Fine	7 1/4" (185mm)	
R8932	Curved Up	9 1/2" (240mm)	



R8925



R8926

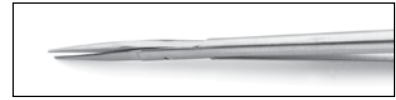

R8927



R8928



R8929

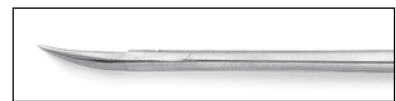

R8930

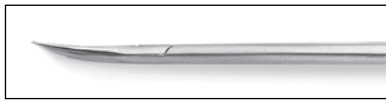

R8931

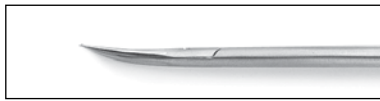

R8931S



R8932

**Fukushima-Giannotta Micro Bayonet Needle Holders**  
flat handle

Catalog#	Description	Length	Jaw Size
R8933	Straight	7 3/4" (200mm)	1 x 11mm
R8934	Curved Up	7 3/4" (200mm)	0.8 x 11mm



R8933

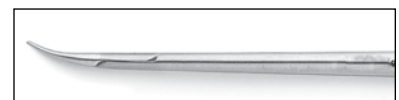

R8934

**Titanium Scissors**

flat handle

Catalog#	Description	Length
651365	Straight	6½" (168mm)
651366	Curved	6½" (168mm)



651365

**Titanium Scissors**

round handle

Catalog#	Description	Length
651375	Straight	7¼" (181mm)
651376	Curved	7¼" (181mm)



651376

**Titanium Bayonet Scissors**  
flat handle

Catalog#	Description	Length
651367	Straight/Regular	8¾" (220mm)
651370	Straight/Fine	8½" (216mm)
651368	Curved Up/Regular	8¾" (220mm)
651371	Curved Up/Fine	8½" (217mm)
651369	Curved Down/Regular	8¾" (220mm)



651368

**Titanium Bayonet Scissors**  
round handle

Catalog#	Description	Length
651377	Straight	8½" (219mm)
651378	Curved	8½" (219mm)



651377



**Jacobson Micro Needle Holders**  
round handle

Catalog#	Description	Length	Tip Size
RN8297	Straight with Lock	7" (180mm)	1 x 11.5mm
RN8298	Straight with Lock	8¼" (210mm)	1 x 11.5mm
RN8299	Straight with Lock	9" (230mm)	1 x 11.5mm



RN8297

**Jacobson Micro Bayonet Needle Holders**  
flat handle

Catalog#	Description	Length	Tip Size
RN8136	Straight	7¼" (185mm)	0.8 x 12mm
RN8137	Curved	7¼" (185mm)	0.8 x 12mm



RN8137

**Micro Bayonet Needle Holders With Lock**  
round handle

Catalog#	Description	Length	Tip Size
RN6271	Straight	8½" (216mm)	1 x 11.5mm
RN6272	Curved	8½" (216mm)	1 x 11.5mm
RN6273	Straight	9¼" (235mm)	1 x 11.5mm
RN6274	Curved	9" (230mm)	1 x 11.5mm



RN6271

**Micro Needle Holder With Lock**  
flat handle

Catalog#	Description	Length
R8210	Slightly Curved	7" (180mm)



**Yasargil Micro Bayonet Needle Holders**  
flat handle

Catalog#	Description	Length	Tip Width
RN8025	Straight	8¾" (225mm)	0.8mm
RN8026	Curved	9¼" (235mm)	0.75mm



RN8026

**Yasargil Micro Bayonet Needle Holders**  
flat handle

Catalog#	Description	Length
RB9250	Straight	7¾" (200mm)
RB9251	Curved	7¾" (200mm)
RB9252	Straight	9" (230mm)
RB9253	Curved	9" (230mm)



RB9250



**Titanium Bayonet Needle Holders With Lock**  
flat handle

Catalog#	Description	Length	Tip Width
651388	Straight	8½" (219mm)	1mm
651389	Straight	8½" (216mm)	0.5mm
651390	Curved	8¾" (224mm)	1mm



651388

**Titanium Round Handled Bayonet Needle Holders**  
round handle

Catalog#	Description	Length	Tip Width
651394	Straight	8½" (216mm)	1mm
651395	Curved	8½" (216mm)	1mm



651394



### Kurze Dissecting Scissors

Catalog#	Description	Working Length	Blade Length
RN7021	Straight	5½" (140mm)	8.5mm
RN7022	Curved Left	5½" (140mm)	8.5mm
RN7023	Curved Right	5½" (140mm)	8.5mm



### Nasal Scissors

Catalog#	Description	Working Length	Blade Length
RN7061	Straight	5⅛" (130mm)	15mm



### Olivecrona Alligator Scissors

Catalog#	Description	Length	Blade Length
R1925	Straight	6" (155mm)	18mm



**Ring Handled Microsurgical Forceps**

Catalog#	Description	Working Length	Tip Size
R8850	Straight	5 <sup>3</sup> / <sub>8</sub> " (135mm)	0.7 x 6mm
R8851	Angled Right	5 <sup>3</sup> / <sub>8</sub> " (133mm)	0.5 x 6mm
R8852	Angled Left	5 <sup>3</sup> / <sub>8</sub> " (133mm)	0.5 x 6mm
R8855	Straight	5 <sup>3</sup> / <sub>8</sub> " (133mm)	1 x 6mm
R8856	Angled Right	5 <sup>3</sup> / <sub>8</sub> " (133mm)	1 x 6mm
R8857	Angled Left	5 <sup>3</sup> / <sub>8</sub> " (133mm)	1 x 6mm
R8858	Straight	5 <sup>3</sup> / <sub>8</sub> " (133mm)	2 x 6mm

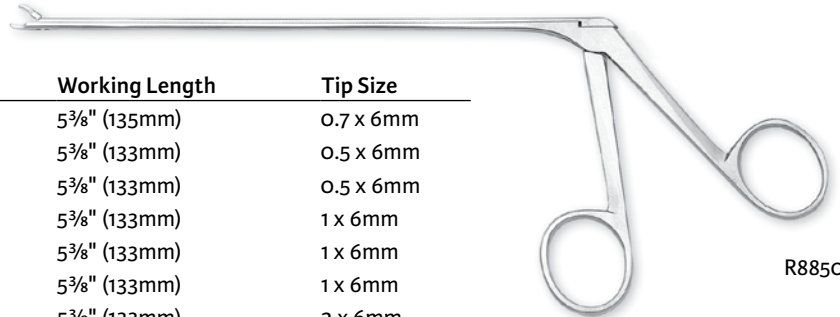

R8850

**Micro Alligator Grasping Forceps and Scissors**  
stationary lower jaw

Catalog#	Description	Working Length	Tip Size
R8645	Round Cup	7" (178mm)	2.3mm
R8646	Serrated Jaw	7 <sup>1</sup> / <sub>4</sub> " (183mm)	1 x 8mm
R8647	Scissors	7" (180mm)	4.5mm

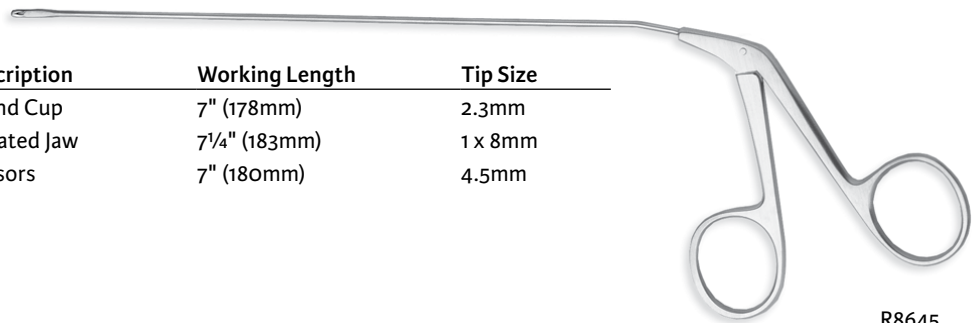

R8645

**Ring Handled Microsurgical Scissors**

Catalog#	Description	Working Length	Blade Length
R8860	Blunt, Straight	5 <sup>1</sup> / <sub>2</sub> " (140mm)	8mm
R8861	Blunt, Curved Right	5 <sup>1</sup> / <sub>2</sub> " (140mm)	8mm
R8862	Blunt, Curved Left	5 <sup>1</sup> / <sub>2</sub> " (140mm)	8mm

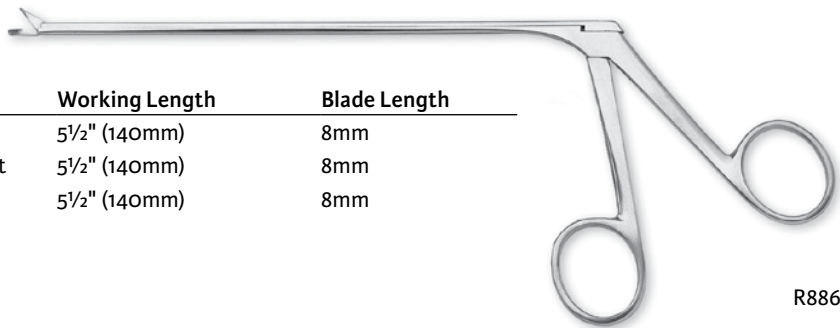

R8861



### Micro Cup Forceps

Catalog#	Description	Working Length	Cup Size
RB9617	Straight	7¾" (200mm)	2.5mm
RB9618	Up	7¾" (200mm)	2.5mm
RB9619	Down	7¾" (200mm)	2.5mm

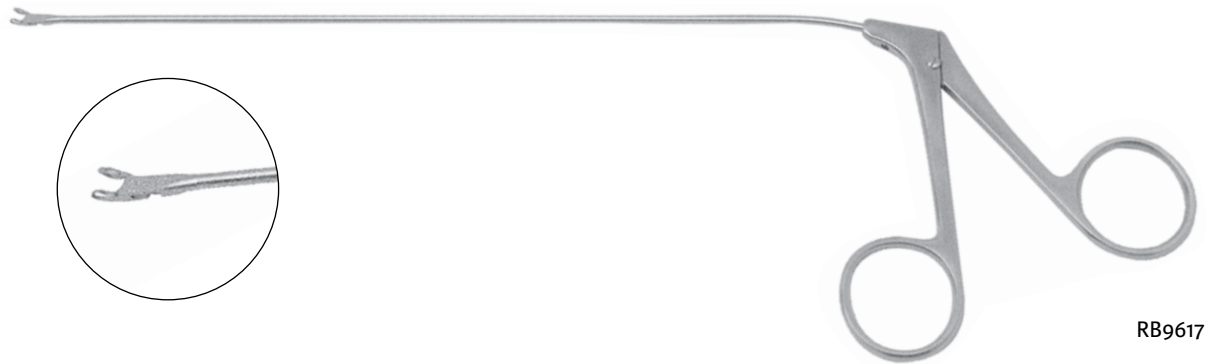

RB9617

### Weil-Blakesley Forceps

Catalog#	Description	Working Length	Tip Width
RN5423	#1, 45° Up	4½" (115mm)	4mm
RN5424	#1, Straight	4½" (115mm)	4mm



RN5423

**Raney Clip Applying Forceps**

Catalog#	Length
RNo140	6¼" (156mm)



**Septal Breakers**

Catalog#	Description	Length
RNo331	Up Opening	6¼" (161mm)
RNo332	Down Opening	6¼" (161mm)
RNo330	Pair of Up and Down Opening	-

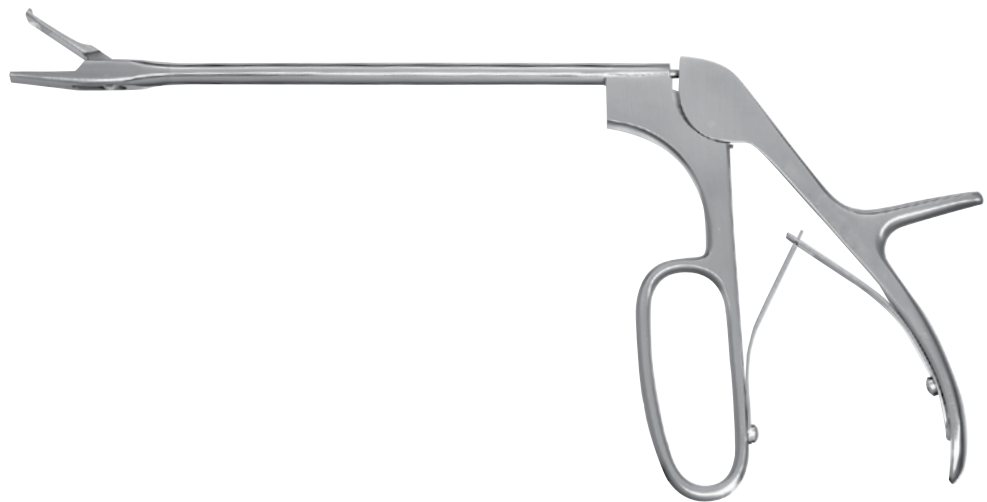

RNo331



## Speculum

Catalog#	Length
R7401	70mm
R7402	88mm
R7403	110mm



R7401

## Transphenoidal Speculum

black

Catalog#	Length
RN2575	70mm
RN2576	80mm
RN2577	90mm
RN2578	100mm



RN2578

**Fukushima Transphenoidal Micro Ring Curettes**  
9" (229mm) length

**Ring Curette**



Catalog#	Description	Ring Diameter	R8865
R8865	30° Angle	2mm	
R8866	45° Angle	2mm	
R8867	30° Angle	2.5mm	
R8868	45° Angle	2.5mm	
R8869	30° Angle	3mm	
R8870	50° Angle	3mm	
R8871	45° Angle	4mm	
R8872	55° Angle	5mm	
R8873	45° Angle	6mm	
R8874	45° Angle	7mm	
R8875	Malleable Shaft	5mm	

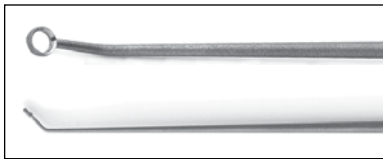

R8866



R8867



R8868

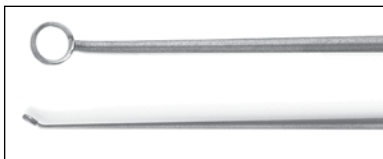

R8869

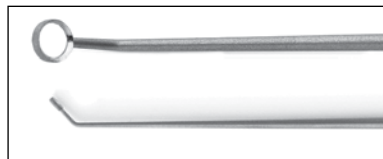

R8870

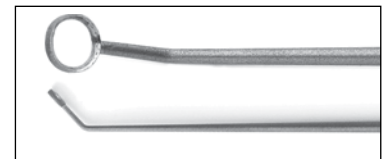

R8871

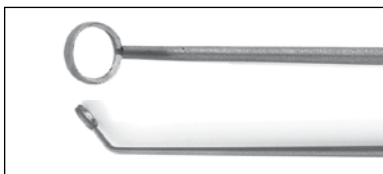

R8872



R8873



R8874



R8875



**Transphenoidal Instruments**

9<sup>3</sup>/<sub>4</sub>" (248mm) length

**Curettes**

Catalog#	Description	Ring Size
RN6301	Angle Up	3mm
RN6302	Angle Up	5mm
RN6303	90° Angle Down	3mm
RN6304	90° Angle Down	5mm
RN6305	45° Angle Right	3mm
RN6305L	45° Angle Left	3mm
RN6306	45° Angle Right	5mm
RN6306L	45° Angle Left	5mm
RN6307	45° Angle Up	3mm
RN6308	45° Angle Up	5mm
RN6323	45° Angle Down	3mm
RN6324	45° Angle Down	5mm



RN6301

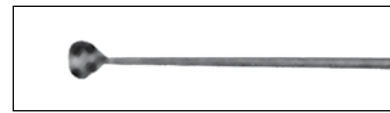

RN6306



RN6302



RN6307

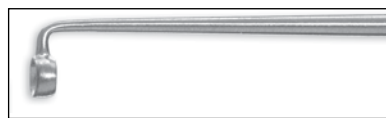

RN6303



RN6308



RN6304



RN6323



RN6305



RN6324



**Transphenoidal Instruments - Continued**  
9¾" (248mm) length

**Dissectors**

Catalog#	Description	Tip Width
RN6309	Angle Up	1.5mm
RN6310	Angle Down	1.7mm



RN6309



RN6310

**Enucleators**

Catalog#	Description
RN6311	Bayonet Micro, Left
RN6312	Bayonet Micro, Right
RN6313	Bayonet Standard, Left
RN6314	Bayonet Standard, Right



RN6311

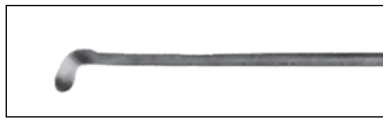

RN6312



RN6313



RN6314

**Knife Handles**

Catalog#	Description
RN6315	Bayonet Vertical
RN6316	Bayonet Lateral



RN6315

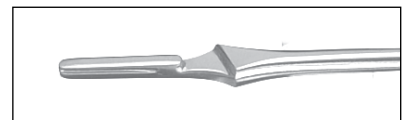

RN6316



## Endoscopic Endonasal Pituitary Instrument Set

This universal and comprehensive instrument set is intended to facilitate the endoscopic endonasal pituitary procedure. The set has also been designed with the versatility to accommodate standard microscopic transphenoidal surgical technique.

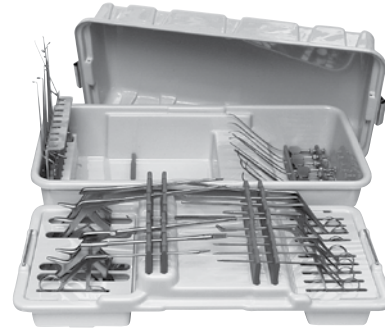

Set includes one each of items listed below and one Instrument Tray RS5000

Catalog#	Instrument	Description	Length
RN0331	Septal Breaker	Up	-
RN0326	Cottle Septum Elevator	Double Ended, Graduated	8½" (216mm)
RN0883	Micro Bayonet Curette	Straight, 3-o	9" (229mm)
RN4872	Micro Kerrison	2mm, 90° Down	8" (203mm)
RN4882	Micro Kerrison	2mm, 40° Up	8" (203mm)
RN4891	Micro Kerrison	1mm, 40° Up	8" (203mm)
RN5423	Weil Blakesely Forceps	40° Up, Size 1	4½" (115mm)
RN5424	Weil Blakesely Forceps	Straight, Size 1	4½" (115mm)
RN5712H	Cushing IVD Rongeur	Straight, 2 x 10mm	7" (180mm)
RN5722H	Cushing IVD Rongeur	Up, 2 x 10mm	7" (180mm)
RN5780	Cushing IVD Rongeur	Straight, 1.5 x 10mm	7" (178mm)
RN6021	Hook	45° Angle	9¾" (246mm)
RN6301	Transphenoidal Bayonet Curette	3mm, 90° Up	9¾" (248mm)
RN6302	Transphenoidal Bayonet Curette	5mm, 90° Up	9¾" (248mm)
RN6303	Transphenoidal Bayonet Curette	3mm, 90° Down	9¾" (248mm)
RN6304	Transphenoidal Bayonet Curette	5mm, 90° Down	9¾" (248mm)
RN6307	Transphenoidal Bayonet Curette	3mm, 45° Up	9¾" (248mm)
RN6308	Transphenoidal Bayonet Curette	5mm, 45° Up	9¾" (248mm)
RN6323	Transphenoidal Bayonet Curette	3mm, 45° Down	9¾" (248mm)
RN6324	Transphenoidal Bayonet Curette	5mm, 45° Down	9¾" (248mm)
RN7021	Kurze Dissecting Scissors	Straight	5½" (140mm)
RN7022	Kurze Dissecting Scissors	Curved Left	5½" (140mm)
RN7023	Kurze Dissecting Scissors	Curved Right	5½" (140mm)
RN7061	Nasal Scissors	Adult Straight	6¼" (160mm)
RN7131	Decker Intervertebral Disc Rongeur	Straight, 1.5 x 5mm Cup	6" (152mm)
RN82325	Endonasal Suction Tube	5 Fr, Angled Short Curved Up	8" (203mm)
RN82327	Endonasal Suction Tube	7 Fr, Angled Short Curved Up	8" (203mm)
RN82425	Endonasal Suction Tube	5 Fr, Angled Long Curved Up	8" (203mm)
RN82427	Endonasal Suction Tube	7 Fr, Angled Long Curved Up	8" (203mm)
RN82525	Endonasal Suction Tube	5 Fr, Angled Straight Tip	8" (203mm)
RN82527	Endonasal Suction Tube	7 Fr, Angled Straight Tip	8" (203mm)
RN825211	Endonasal Suction Tube	11 Fr, Angled Straight Tip	8" (203mm)
RN82625	Endonasal Suction Tube	5 Fr, Angled Short Curved Down	8" (203mm)
RN82627	Endonasal Suction Tube	7 Fr, Angled Short Curved Down	8" (203mm)
RN82725	Endonasal Suction Tube	5 Fr, Angled Long Curved Down	8" (203mm)
RN82727	Endonasal Suction Tube	7 Fr, Angled Long Curved Down	8" (203mm)

**Reflective Spheres**

Catalog#	Description	Unit
RB8800737	5 pouches/box	each pouch contains 1 sphere
RB8800738	5 pouches/box	each pouch contains 3 spheres
RB8800739	5 pouches/box	each pouch contains 4 spheres



**Integra**<sup>®</sup>  
Index

ACF Blade Ejector.....24	Ball Hooks.....8	Bipolar Forceps.....170-182
ACF Iliac Blades.....24	Ballenger Septum Elevator .....15	Bipolar Forceps Cord.....182
ACF Instruments.....22-26	Bar Ejector Kerrison Rongeurs .....104, 107	Bipolar Forceps Tray.....175, 182
ACF Longitudinal Body Retractor .....23	Bayonet Bipolar Forceps.....171-179, .....182	Bipolar Forceps, Bayonet.....171-179, .....182
ACF Longitudinal Retractor Blades .....23	Bayonet Cup Curettes.....120-121, .....123-126, .....160	Bipolar Forceps, BUZZ.....177-182
ACF Medial Retractor Blades 23	Bayonet Curettes.....120-121, .....123-126, .....151, 160, .....200-201, .....203	Bipolar Forceps, Non-Stick...177-182
ACF Screwdriver.....22	Bayonet Forceps.....167-169	Blade Ejector.....35
ACF System.....22-26	Bayonet Instruments.....78-80, .....91, 102, .....120-121, .....123-126, .....151-156, .....160, 164- .....165, 167- .....169, 171- .....174, 176- .....179, 182, .....185-188, .....190-194, .....200-201, .....203	Blade Ejector.....24, 27-28, .....35
ACF Transverse Body Retractor .....23	Bayonet Intervertebral Disc Rongeurs .....78-80	Blade Ejector, ACF.....24
ACF Twist Drill.....22	Bayonet Kerrison Rongeurs .....91, 102	Blade Ejector, LumbarTrak ....35
Adson Bayonet Forceps.....167	Bayonet Micro Instruments .....152-156, .....160	Blades, Hook.....37
Adson Bipolar Forceps.....170	Bayonet Needle Holders.....188, .....191-194	Blades, Hook.....44
Adson Cerebellar Retractor .....63	Bayonet Probes.....185-188, .....190	Blades, Hook Set.....31
Adson Dura Hooks.....6	Bayonet Ring Curettes.....151, .....200-201, .....203	Blades, Iliac.....24
Adson Periosteal Elevators...13	Bayonet Scissors.....185-188, .....190-191	Blades, Lateral.....24
Adson Rongeur.....71	Bayonet Tumor Forceps.....169	Blades, Medium.....36
Adson Suction Tubes.....131	Beckman-Adson Retractors..64	Blades, Narrow.....44
Alligator Scissors.....195	Beckman-Eaton Retractor ....64	Blades, Sacral.....37
Anderson-Adson Cerebellar Retractor .....63	Beyer Rongeur.....74	Blades, Spinal Retraction System .....33
Angled Curettes.....120	Bipolar Bayonet Forceps.....171-179, .....182	Blades, T-Bar.....29
Angled Self-Retaining Retractors .....62	Bipolar Bayonet Forceps, Apfelbaum .....175	Blades, Thin.....36
Anterior Cervical Fusion Distraction System.....22-26	Button Hooks.....8	Blades, Titanium.....36-37
Anterior Cervical Fusion Tray .....26	BUZZ Accessories.....182	Blades, Wide.....36
Apfelbaum Bipolar Bayonet Forceps .....175	BUZZ Bipolar Trays.....182	Blades, Wide.....44
Apfelbaum Dissecting Instruments .....143-147	BUZZ Lite Non-Stick Bipolar Forceps .....182	Bone Curettes.....119
Apfelbaum Dissecting Instruments .....144-146	BUZZ Non-Stick Bipolar Forceps .....177-181	Bone Cutters.....70, 124-126
Apfelbaum Extended Reach Curettes .....118	BUZZ Stylet.....182	Bone Cutting Forceps.....70
Apfelbaum Micro Dissection Mirror .....147	Caliper.....24	Bone Graft Harvesting Forceps .....25
Arachnoid Knives.....157, 165	Carbon Fiber Retractor Blades .....26	Bone Graft Holder.....25
Army Navy Retractor.....53		Bone Graft Impactors.....25
Atraumatic Tip Suction Tubes .....132-134		Bone Mallet.....19
Atraumatic Tip Suction Tubes .....132-134		Bone Rongeurs.....71-75
Bacon Rongeur.....71		Bone Waxers.....124-126
Bailey Gigli Saw Guides.....4		
Ball Dissectors.....142		

- Carpal Tunnel Retinaculotomes .....5  
 Caspar Intervertebral Disc Rongeurs .....86  
 Caspar Style Bone Graft Harvesting Forceps .....25  
 Caspar Style Bone Graft Holder .....25  
 Caspar Style Bone Graft Impactors .....25  
 Caspar Style Caliper.....24  
 Caspar Style Nerve Root Retractors .....51  
 Caspar Style Vertebral Body Dissectors .....25  
 Center Retractor Blades .....27  
 Cerebellar Pontine Tumor Bayonet Micro Instruments .....154-156  
 Cerebellar Retractors.....62-63  
 Cervical Bayonet Curettes.....124-125  
 Cervical Bayonet Curettes, XL .....125  
 Cervical Distractors .....22  
 Cervical Impactors.....20  
 Cervical Lamina Spreader .....54  
 Cervical Vertebral Spreader ..54  
 Cherry Handle Kerrison Rongeur .....107  
 Clip Applying Forceps.....198  
 Cloward Style Depth Gauge .....24  
 Cloward Type Blade Retractors .....53  
 Cloward Type Cervical Vertebral Spreader .....54  
 Cloward Type Lamina Spreader .....54  
 Cobb Style Bone Curettes .....119  
 Cobb Type Spinal Elevators ..17  
 Cone Ring Curettes .....122  
 Cord .....182  
 Cottle Septum Elevator .....15, 203  
 Cranial Rongeur .....70  
 Cup Curettes .....42, 112-121, 123-126, 144, 146, 149, 157, 160, 203  
 Curette Trays.....115, 117, 123  
 Curettes.....42, 112-126, 144, 146, 151, 155, 157, 160, 200-201, 203  
 Curettes, Bayonet.....120-126  
 Curettes, Bayonet.....120-121, 123-126, 151, 160, 200-201, 203  
 Curettes, Bone .....119  
 Curettes, Cervical.....124-125  
 Curettes, Cup.....120-121, 123-126, 160  
 Curettes, Ring .....122  
 Curettes, Ring .....200-201  
 Curettes, Ring .....151, 200-201, 203  
 Curettes, Ultra-Coat .....112-113  
 Curved Kerrison Rongeurs ....99, 105  
 Cushing Bipolar Forceps .....170  
 Cushing Decompression Retractor .....52  
 Cushing Dura Hook .....6  
 Cushing Gasserian Ganglion Hook .....8  
 Cushing Intervertebral Disc Rongeurs .....77-81, 203  
 Cushing Periosteal Elevator..14  
 Cushing Vein Retractor .....52  
 Cutters, Bone.....70, 124-126  
 Cutting Forceps, Bone .....70  
 Dandy Nerve Hooks.....8  
 Davis Nerve Separator and Spatula .....10  
 Davis Scalp Retractor .....56  
 Davis Spatulas .....47  
 DeBakey Forceps .....42, 167  
 Decker Intervertebral Disc Rongeurs .....88  
 Decompression Retractor .....52  
 Depth Gauge, Cloward Style .....24  
 Depth Gauge, Flexi-Spine.....30  
 Depth Gauge, LumbarTrak....35  
 Depth Gauges.....24, 30, 35  
 D'Errico Nerve Root Retractor .....49  
 Detach Kerrison Rongeurs....89, 93, 95, 96, 98, 100  
 DeVilbiss Cranial Rongeur ....70  
 Diamond Bayonet Cushing Intervertebral Disc Rongeurs .....78  
 Diamond Bayonet Love-Greunwald Intervertebral Disc Rongeurs .....78  
 Diamond Bayonet Spurling Intervertebral Disc Rongeurs .....78  
 Diamond IVD Rongeurs.....78  
 Diamond Detach Kerrison Rongeurs .....95-96  
 Diamond Kerrison Rongeurs .....95-97  
 Diamond Medium Kerrison Rongeurs .....96  
 Diamond Medium Kerrison Rongeurs, Detach .....96  
 Diamond Micro Kerrison Rongeurs .....95  
 Diamond Micro Kerrison Rongeurs, Bayonet .....97  
 Diamond Micro Kerrison Rongeurs, Detach .....95  
 Diamond Spurling Kerrison Rongeurs .....97  
 Disc Dissectors.....42  
 Disc Rongeurs .....42, 77-78, 80-85, 87-88  
 Dissectomy Retractors .....60  
 Dissecting Scissors .....195, 203  
 Dissection Hooks.....162-164  
 Dissection Instruments.....10-12, 25, 42, 118, 126, 140-167  
 Dissection Mirror .....147  
 Dissection Sets.....140, 147-152  
 Dissection Trays .....142, 146  
 Instrument Trays, Dissection .....142, 146  
 Trays, Dissecting Instruments .....142, 146  
 Dissectors .....12  
 Dissectors .....10-12, 25, 42, 118,

.....	126,	Instrument Set .....	203	Fukushima-Giannotta Micro Bayonet	
.....	141-147,	Enucleators .....	202	Scissors .....	188
.....	149-150,	Epstein Currettes .....	119	Fukushima-Giannotta Skull Base and	
.....	156, 158,	Evandro De Oliveira Micro Scissors		Dissectors .....	149,
.....	160-161	.....	184	.....	150-152
Dissectors, Ball .....	142	Extended Reach Currettes .....	118	Fulton Rongeurs .....	75
Dissectors, Micro .....	141-165	Feler-Ducker Retractors .....	60	Ganglion Hook .....	8
Distraction Screws .....	22	Fenestrated Iliac Blades .....	24	Gardner-Wells Traction Tongs Set	
Distraction System .....	22-26	Ferris-Smith Intervertebral Disc		.....	68
Distractor Drill Guides .....	22	Rongeurs .....	88	Gelpi Perineal Retractors .....	58
Distractors .....	22	Ferris-Smith Kerrison Rongeurs		Gerald Bipolar Bayonet Forceps	
Distractors .....	25	.....	102, 109	.....	171
Distractors, Cervical .....	22	Flatback Currettes .....	42, 113	Gerald Forceps .....	168
Dorsey Dura Separator .....	9	Flatback Spinal Fusion Currettes		Gerzog Bone Mallet .....	19
Double Action Rongeurs .....	72-73	.....	116	Gigli Handles .....	2-3
Double Ended Dura Separator		Flexi-Spine Blade Sets .....	31	Gigli Saw Handles .....	2
.....	9	Flexi-Spine Depth Gauge .....	30	Gigli Wire Saw Blades .....	4
Double Round Bars .....	57	Flexi-Spine Hook Set .....	31	Grasping Forceps .....	196
Dressing Forceps .....	168	Flexi-Spine Instrument Tray		Hand-Held Retractors .....	45-53
Drill Guides .....	22	.....	30	Handle, Retractor .....	31, 32
Duckbill Rongeur .....	72, 74	Flexi-Spine Longitudinal Retractor		Hardy Style Bipolar Bayonet Forceps	
Ducker Retractors .....	59	Body .....	30	.....	172
Dura Dissectors .....	10-11	Flexi-Spine Retraction System		Haverfield-Scoville Type	
Dura Hooks .....	163	.....	30-31	Hemilaminectomy Retractor	
Dura Hooks .....	6, 163	Flexi-Spine Retractor Blade Handle		.....	65
Dura Knives .....	144, 146	.....	31	Hemilaminectomy Blades .....	66-67
Dura Packers .....	12	Flexi-Spine Transverse Retractor Body		Hemilaminectomy Hooks .....	65
Dura Separator and Packer ...	12	.....	30	Hemilaminectomy Retractor	
Dura Separators .....	9	Forceps .....	42,	.....	65
Dura Spatulas .....	48	.....	166-172,	Hercules Supercutter .....	76
Dural Elevator and Spatulas		.....	196-197,	Hibbs Type Hemilaminectomy Blades	
.....	16	.....	203	.....	67
Early Spinal Fusion Knife .....	5	Forceps, Tungsten Carbide ...	168-169	Hinged Self-Retaining Retractor	
Echlin Angular Duckbill Rongeurs		Forceps, Bayonet .....	167-169	.....	61
.....	74	Forceps, Bipolar .....	170-182	Hoehn Nerve Hooks .....	8
Ejector Kerrison Rongeurs ...	91-92, 98,	Forceps, Clip Applying .....	198	Hoehn Retractor .....	62
.....	104, 107	Forceps, Non-Stick Bipolar ...	177-182	Holscher Nerve Root Retractor	
Elevator, Septum .....	15, 203	Forceps, Tumor .....	169	.....	50
Elevators .....	10, 12-17	Frazier Dura Separator .....	9	Hook Blades .....	29
Elevators .....	10, 12-17,	Frazier Suction Tubes .....	128-130	Hook Blades, LumbarTrak .....	37
.....	141, 143,	Freer Elevator .....	10	Hook Blades, McCulloch .....	44
.....	145, 160	Fukushima Transphenoidal Micro Ring		Hook Set, Flexi-Spine .....	31
Elevators, Cobb Type .....	17	Currettes .....	200-201	Hooks .....	6- 8, 29,
Elevators, Periosteal .....	13-15	Fukushima-Chen Micro Instruments		.....	33, 37, 44,
Elevators, Spinal .....	17	.....	154-156	.....	141, 144,
Endonasal Instruments .....	7, 135	Fukushima-Giannotta Dissectors		.....	146, 149,
Endonasal Pituitary Hook .....	7	.....	149	.....	159, 162-
Endonasal Suction Tubes .....	135, 203	Fukushima-Giannotta Instrument Tray		.....	164, 203
Endoscopic Endonasal Pituitary		.....	149	Hooks, Ball .....	8
		Fukushima-Giannotta Micro Bayonet		Hooks, Button .....	8
		Needle Holders .....	188	Hooks, Dissecting .....	162-164



- Hooks, Dura .....6, 163  
 Hooks, Nerve.....8  
 Hooks, Spinal .....33  
 Iliac Blades .....24  
 Iliac Blades, ACF .....24  
 Impactors .....20  
 Impactors, Bone Graft .....25  
 Impactors, Cervical.....20  
 Inge Lamina Spreader.....55  
 Instrument Trays .....26, 30, 32,  
 .....37, 41-43,  
 .....110, 115,  
 .....117, 123,  
 .....142, 144,  
 .....146, 149,  
 .....151, 175,  
 .....182, 187,  
 .....203  
 Instrument Trays, Apfelbaum Micro  
 Dissection .....144, 146  
 Instrument Trays, Bipolar.....175, 182  
 Instrument Trays, Buzz .....182  
 Instrument Trays, Currettes ...115, 117, 123  
 Instrument Trays, Endoscopic  
 Endonasal Pituitary.....203  
 Instrument Trays, Flexi-Spine  
 .....30  
 Instrument Trays, Fukushima-Giannota  
 Micro Instruments .....149  
 Instrument Trays, Kerrison...110  
 Instrument Trays, McCulloch  
 .....43  
 Instrument Trays, Micro Bayonet  
 Scissors .....187  
 Instrument Tray,s Trans-Oral  
 .....41  
 Instrument Trays, LumbarTrak  
 .....37  
 Instrument Trays, Rhoton Style Micro  
 Dissection .....142  
 Intervertebral Disc Rongeurs  
 .....42, 77-78,  
 .....80-88, 203  
 Intervertebral Disc Rongeurs, Bayonet  
 .....78-80  
 Intervertebral Disc Rongeurs, Caspar  
 .....86  
 Intervertebral Disc Rongeurs, Cushing  
 .....77-81, 203  
 Intervertebral Disc Rongeurs, Decker  
 .....88  
 Intervertebral Disc Rongeurs,  
 Love-Greunwald .....78-80  
 Intervertebral Disc Rongeurs, Micro  
 .....87  
 Intervertebral Disc Rongeurs, Spurling  
 .....78-80  
 Intervertebral Disc Rongeurs,  
 Ultra-Coat.....79  
 Intervertebral Disc Rongeurs, Wave  
 .....77  
 Intervertebral Disc Rongeurs, Diamond  
 .....78  
 Iris Bipolar Forceps .....170  
 IVD Rongeurs.....42, 77-88,  
 .....203  
 Jackson Intervertebral Disc Rongeurs  
 .....87  
 Jacobson Micro Bayonet Needle  
 Holders .....191  
 Jacobson Micro Bayonet Scissors  
 .....185  
 Jacobson Micro Needle Holders  
 .....191  
 Jacobson Micro Suture Pusher  
 .....148  
 Jacobson Probes .....148  
 Jacobson Scissors.....183  
 Jacobson Vessel Knife.....147  
 Janetta Double Round Bars ...57  
 Janetta Malleable Blades .....57  
 Janetta Retractor Body .....57  
 Jenson Bipolar Bayonet Forceps  
 .....176  
 Jeweler's Bipolar Forceps .....170  
 John Day Periosteal Elevator  
 .....15  
 Joseph Periosteal Elevator ....13  
 Kerrison Instrument Tray .....110  
 Kerrison Rongeur, Cherry Handle  
 .....107  
 Kerrison Rongeur, Curved.....99, 105  
 Kerrison Rongeurs .....89-109,  
 .....203  
 Kerrison Rongeurs, Bayonet  
 .....102  
 Kerrison Rongeurs, Curved...105  
 Kerrison Rongeurs, Detach...89, 93, 95,  
 .....97, 100-101  
 Kerrison Rongeurs, Diamond  
 .....100-102  
 Kerrison Rongeurs, Ejector...91-92, 95,  
 .....104, 107  
 Kerrison Rongeurs, Micro .....89-92,  
 .....95-96,  
 .....100, 102-  
 .....105, 203  
 Kerrison Rongeurs, Spurling  
 .....94, 97, 101,  
 .....106-107  
 Kerrison Rongeurs, Stainless Steel  
 .....103-109  
 Kerrison Rongeurs, Stealth...98-102  
 Kerrison Rongeurs, Ultra-Coat  
 .....89-94  
 Knife Handles .....124-125,  
 .....202  
 Knives .....5, 124-125,  
 .....144, 146-  
 .....147, 149,  
 .....153-154,  
 .....157, 165,  
 .....202  
 Knives, Arachnoid .....157, 165  
 Knives, Dura.....144, 146  
 Knives, Handles.....124-125,  
 .....202  
 Knives, Vessel .....147  
 Krayenbuhl Hooks.....162  
 Krayenbuhl Twist Hooks .....162  
 Kurze Dissecting Scissors .....195, 203  
 Lahey Clinic Dura Hook.....7  
 Lambotte Osteotomes .....18  
 Lamina Spreaders .....54-55  
 Lateral Retractor Blades .....24  
 Lateral Retractor Clamp .....41  
 Lateral Retractors.....40  
 Leksell Rongeurs .....75  
 Lempert Rongeur .....71  
 Ligature Carrier .....147  
 Ligature Needles .....165  
 Liston Bone Cutting Forceps  
 .....70  
 Long Connector, LumbarTrak  
 .....35  
 Long Teeth Retractor Blades  
 .....31, 33  
 Longitudinal Retractor Body, ACF  
 .....23  
 Longitudinal Retractor Blades  
 .....23  
 Longitudinal Retractor Blades, ACF



.....23	McCravey Tissue Forceps.....167	.....149,
Longitudinal Retractor Body	McCulloch Hook Blades.....44	.....151-152,
.....30, 32	McCulloch Narrow Blades ....44	.....156, 158,
Longitudinal Retractor Body,	McCulloch Retractor Body....43	.....160-161
Flexi-Spine.....30	McCulloch Retractor Set.....43	Micro Dura Hooks.....163
Longitudinal Retractor Body, Spinal	McCulloch Retractor Tray ....43	Micro Dura Knives.....144, 146
.....32	McCulloch Toothed Hook Blades	Micro Elevators .....141, 143,
Love Bayonet Nerve Root Retractor	.....44	.....145, 160
.....50	McCulloch Wide Blades .....44	Micro Forceps .....166
Love Nerve Root Retractors..50	Medial Retractor Blades.....23	Micro Hooks .....141, 149,
Love-Adson Periosteal Elevator	Medial Retractor Blades, ACF	.....159,
.....13	.....23	.....162-164
Love-Gruenwald Intervertebral Disc	Medium Blades, LumbarTrak	Micro Instruments .....140-203
Rongeurs.....42, 77-80,	.....36	Micro Instruments, Bayonet.
.....82	Medium Kerrison Rongeurs..93, 97, 101,	.....152-156,
Lumbar and Cervical Impactors	.....108	.....160
.....20	Meyerding Retractors.....52, 58	Micro Kerrison Rongeurs .....89-92,
Lumbar Bayonet Curettes ....126	Meyerding Type Hemilaminectomy	.....95-96,
LumbarTrak Blade Ejector ....35	Blades .....66	.....100,
LumbarTrak Depth Gauge.....35	Micro Alligator Grasping Forceps and	.....102-105,
LumbarTrak Hook Blades .....37	Scissors .....196	.....203
LumbarTrak Instrument Tray	Micro Angled Curettes .....120	Micro Kerrison Rongeurs, Bar Ejector
.....37	Micro Arachnoid Knife .....157, 165	.....104, 107
LumbarTrak Long Connector	Micro Bayonet Curettes.....120, 160,	Micro Kerrison Rongeurs, Curved,
.....35	.....200-201,	Hinged.....105
LumbarTrak Medium Blades	.....203	Micro Kerrison Rongeurs, Curved,
.....36	Micro Bayonet Needle Holders	Hingeless .....105
LumbarTrak Quick Connector	.....188, 191,	Micro Kerrison Rongeurs, Detach
.....35	.....193	.....89, 95, 98
LumbarTrak Retraction System	Micro Bayonet Nerve Hooks.164	Micro Kerrison Rongeurs, Pin Ejector
.....34-37	Micro Bayonet Probe .....151	.....91-92, 98,
LumbarTrak Retractor Blade Handle	Micro Bayonet Scissor Tray...187	.....104
.....35	Micro Bayonet Scissors .....185-188	Micro Knives.....147-154,
LumbarTrak Sacral Blades .....37	Micro Cup Curettes.....152, 155,	.....157
LumbarTrak Scoville Retractor	.....157, 197	Micro Ligature Needles.....165
.....34	Micro Curettes.....142, 144,	Micro Ligature Passer .....159
LumbarTrak Square Retractor	.....146, 151-	Micro Lumbar Discectomy (MLD)
.....34	.....152, 155,	Retraction System.....27
LumbarTrak Thin Blades.....36	.....157, 160,	Micro Needle Holders .....191-194
LumbarTrak Wide Blades .....36	.....200, 201	Micro Nerve Hooks.....159,
Malis-Style Bipolar Bayonet Forceps	Micro Disc IVD Rongeurs .....87	.....163-164
.....176	Micro Dissection Set Components	Micro Probes.....148,
Malis-Style Jensen Bipolar Bayonet	.....141-142	.....150-152,
Forceps .....176	Micro Dissection Set Trays ...142	.....154
Malleable Blades .....57	Micro Dissection Sets .....140-141,	Micro Raspatory.....147-148,
Mallet .....19	.....147-148	.....157-158
Markham-Meyerding Retractors	Micro Dissection Tray, Apfelbaum	Micro Right Angle Hooks.....141, 144,
.....58	.....144, 146	.....146
Martin Nerve Root Retractor	Micro Dissectors .....141,	Micro Ring Curettes.....151, 155,
.....49	.....143-144,	.....200-201
	.....146-147,	Micro Round Dissectors.....143, 145,
		.....161
		Micro Scissors .....183-190,

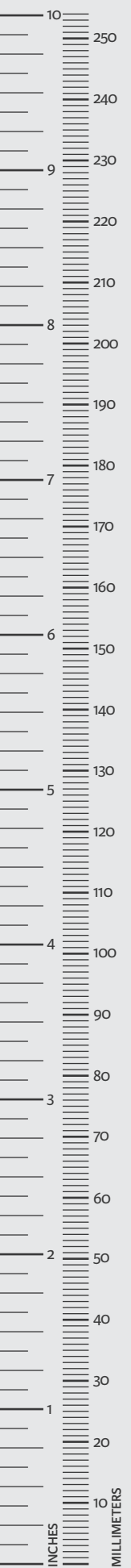

- .....195-196
- Micro Separators.....150
- Micro Spatula Elevators .....143, 145
- Micro Suture Pusher.....148
- Micro Teardrop Dissectors....144, 146
- Micro Titanium Elevators.....160
- Micro Titanium Instruments  
.....159-161
- Micro Vessel Supporter .....159
- Microsurgical Bayonet Instruments  
.....151,  
.....164-165,  
.....185-188,  
.....191-193
- Microsurgical Bipolar Bayonet Forceps  
.....171
- Microsurgical Curettes .....120-121
- Microsurgical Forceps .....166,  
.....196-197
- Microsurgical Instrumentation  
.....140-204
- Microsurgical Scissors.....183-184,  
.....196
- Miskimon Cerebellar Retractor  
.....62
- MLD Center Retractor Blades  
.....27
- MLD Retractor.....27
- MLD Speculum Retractors...27
- Mounting Arms .....39
- Mouth Gag.....41
- Multi-Hole Suction Tubes.....132
- Murphy Ball Hooks .....8
- Nagel Micro Scissors .....184
- Narrow Blades, McCulloch ...44
- Nasal Scissors.....195, 203
- Needle Dissectors.....142
- Needle Holders .....42, 188,  
.....191-194
- Needle Holders, Bayonet .....188,  
.....191-194
- Needle Holders, Micro .....191-194
- Needle Holders, Titanium.....194
- Needles .....165
- Nerve Hooks.....8, 124-126,  
.....159,  
.....163-164
- Nerve Root Retractors.....49-51
- Nerve Separator and Spatula  
.....10
- Non-stick Bipolar Forceps ....177-182
- Oberhill Retractor .....64
- Oldberg Dissector.....12
- Olivecrona Double Ended Dissector  
.....10
- Open-Handle Kerrison Rongeurs  
.....108
- Optional Retractor Blades ....33
- Osteotomes .....18
- Packers .....12
- Paganelli Paine Carpal Tunnel  
Retinaculotome.....5
- Paine's Carpal Tunnel Retinaculotome  
.....5
- Palate Retractor Clamp .....41
- Palate Retractors .....40
- Peapod Intervertebral Disc Rongeurs  
.....84
- Pencil Grip Needle Holder ....42
- Penfield Dissectors .....11, 126
- Perineal Retractors.....58
- Periosteal Elevators .....13-15
- Pin Ejector Kerrison Rongeurs  
.....91-92, 98,  
.....104
- Polishing Cloth.....182
- Poppen Intervertebral Disc Rongeurs  
.....84
- Poppen Suction Tubes.....131
- Potts-Smith Dressing Forceps  
.....168
- Probe Dissector, Insulated ....152
- Probes.....148,  
.....150-152,  
.....154
- Probes, Bayonet .....185-188,  
.....190
- Quick Connector, LumbarTrak  
.....35
- Raney Clip Applying Forceps  
.....198
- Raney Saw Guide .....4
- Raspatories .....147-148,  
.....157-158
- Reflective Spheres .....204
- Retinaculotomes.....5
- Retractor Blade Handle .....31-32, 35
- Retractor Blade Handle, Flexi-Spine  
.....31
- Retractor Blade Handle, LumbarTrak  
.....35
- Retractor Blade Handle, Spinal  
.....32
- Retractor Blades.....23-24,  
.....26-29, 31,  
.....33, 36-37,  
.....44, 65-67
- Retractor Blades, ACF .....24
- Retractor Blades, Blunt .....31, 33
- Retractor Blades, Carbon Fiber  
.....26
- Retractor Blades, Center .....27
- Retractor Blades, Flexi-Spine  
.....31
- Retractor Blades, Flexi-Spine  
.....31
- Retractor Blades, Hook .....37
- Retractor Blades, Hook .....44
- Retractor Blades, Hook Set...31
- Retractor Blades, Lateral.....24
- Retractor Blades, LumbarTrak  
.....36-37
- Retractor Blades, McCulloch  
.....44
- Retractor Blades, Medium ....36
- Retractor Blades, MLD .....27
- Retractor Blades, Narrow.....44
- Retractor Blades, Optional ...33
- Retractor Blades, Sacral .....37
- Retractor Blades, Spinal .....33
- Retractor Blades, Taylor .....28
- Retractor Blades, T-Bar .....29
- Retractor Blades, Thin .....36
- Retractor Blades, Titanium...36-37
- Retractor Blades, UMLD.....28-29
- Retractor Blades, UMLD.....28
- Retractor Blades, Wide.....44
- Retractor Body, McCulloch...43
- Retractor Clamp, Lateral .....41
- Retractor Clamp, Palate .....41
- Retractor Hooks.....29, 31, 33,  
.....37, 44, 65
- Retractor, Decompression ....52
- Retractors .....22-68
- Retractors, Cerebellar.....62-63
- Retractors, Hemilaminectomy  
.....65
- Retractors, Lateral.....40

Retractors, Longitudinal .....	30, 32	Retractors, Self-Retaining ....	54-65	Self-Retaining Retractors.....	54-65
Retractors, McCulloch.....	43	Retractors, Square .....	34	Seltz-Gelpi Retractor.....	58
Retractors, Palate .....	40	Retractors, Transverse .....	30, 32	Semken Bipolar Forceps.....	170
Retractors, Scoville.....	34	Reusable Bipolar Forceps Cord		Semken Forceps .....	169
Retractors, Self-Retaining ....	54-65	.....	182	Senn Retractors.....	52
Retractors, Square .....	34	Rhoton Bipolar Bayonet Forceps		Separators.....	9-10, 12,
Retractors, Transverse .....	30, 32	.....	171	.....	150
Reusable Bipolar Forceps Cord		Rhoton Style Ball Dissectors		Septal and Periosteal Elevators	
.....	182	.....	142	.....	15
Rhoton Bipolar Bayonet Forceps		Rhoton Style Micro Curettes		Septal Breakers.....	198, 203
.....	171	.....	142	Septum Elevators.....	15, 203
Rhoton Style Ball Dissectors		Rhoton Style Micro Dissecting		Serrated Bayonet Scissors ....	187
.....	142	Instruments .....	141-142	Short Teeth Retractor Blades	
Rhoton Style Micro Curettes		Rhoton Style Micro Dissection Set Tray		.....	31, 33
.....	142	.....	142	Silicone Retractors.....	45-46
Rhoton Style Micro Dissecting		Rhoton Style Micro Dissectors		Sisco Bayonet Curettes.....	123
Instruments .....	141-142	.....	141	Smith-Petersen Laminectomy Rongeurs	
Rhoton Style Micro Dissection Set Tray		.....	141	.....	72
.....	142	Rhoton Style Micro Hooks....	141	Smithwick Button Hook.....	8
Rhoton Style Micro Dissectors		.....	141	Snitman Retractor.....	56
.....	141	Rhoton Style Micro Spatula Dissectors		Spatula Dissectors .....	141, 143,
Rhoton Style Micro Hooks....	141	.....	141	.....	145
Rhoton Style Micro Spatula Dissectors		Rhoton Style Needle Dissectors		Spatulas.....	10, 16,
.....	141	.....	142	.....	45-48
Rhoton Style Needle Dissectors		Rhoton-Style Micro Scissors		Specula.....	27, 199
.....	142	.....	184	Speculum Retractors .....	27
Rhoton-Style Micro Scissors		Right Angle Hooks.....	141, 144	Spetzler Sonntag Trans-Oral	
.....	184	Ring Curettes .....	122, 151,	Instruments Set .....	42
Right Angle Hooks.....	141, 144	.....	200-201,	Spetzler Sonntag Trans-Oral Retractor	
Ring Curettes .....	122, 151,	.....	203	System.....	38-41
.....	200-201,	Ring Curettes, Bayonet.....	151,	Spheres.....	204
.....	203	.....	200-201,	Spinal Curettes .....	112-118
Ring Curettes, Bayonet.....	151,	.....	203	Spinal Elevators.....	17
.....	200-201,	Ring Handled Forceps.....	196-198	Spinal Fusion Curette Trays...115, 117, 123	
.....	203	.....	196	Spinal Fusion Curettes.....	112-117
Ring Handled Forceps.....	196-198	Ring Handled Microsurgical Forceps		Spinal Fusion Knife .....	5
Ring Handled Microsurgical Forceps		.....	196	Spinal Hook .....	33
.....	196	Ring Handled Microsurgical Scissors		Spinal Longitudinal Retractor Body	
Ring Handled Microsurgical Scissors		.....	196	.....	32
.....	196	Ring Handled Scissors.....	195-196	Spinal Retraction Systems ....	23-24,
Ring Handled Scissors.....	195-196	Rongeurs, Cranial.....	70	.....	26-37
Rongeurs, Cranial.....	70	Rongeurs .....	70-110	Spinal Retractor Blade Handle	
Rongeurs .....	70-110	Rongeurs, Bayonet Kerrison		.....	32
Rongeurs, Bayonet Kerrison		.....	102	Spinal Retractor Blunt Blades	
.....	102	Rongeurs, Bone .....	71-75	.....	31, 33
Rongeurs, Bone .....	71-75	Rongeurs, Detach Kerrison...89, 93, 95,		Spinal Retractor Long Teeth Blades	
Rongeurs, Detach Kerrison...89, 93, 95,		.....	97, 100-101	.....	31, 33
.....	97, 100-101	Rongeurs, Disc .....	42, 77-78,	Spinal Retractor Short Teeth Blades	
Rongeurs, Disc .....	42, 77-78,	.....	80-85,	.....	31, 33
.....	80-85,	.....	87-88	Spinal Retractor System Tray	
.....	87-88	Rongeurs, Double Action.....	72-73		
Rongeurs, Double Action.....	72-73	Rongeurs, Kerrison .....	89-109		
Rongeurs, Kerrison .....	89-109	Rongeurs, Medium Kerrison			
Rongeurs, Medium Kerrison		.....	101		
.....	101	Rongeurs, Micro Kerrison ....	100, 102		
Rongeurs, Micro Kerrison ....	100, 102	Round Dissectors .....	143, 145,		
Round Dissectors .....	143, 145,	.....	161		
.....	161	Round Handle Bayonet Micro Curettes			
Round Handle Bayonet Micro Curettes		.....	121		
.....	121	Ruggles Specula.....	199		
Ruggles Specula.....	199	Ruggles Spinal Retraction System			
Ruggles Spinal Retraction System		.....	32		
.....	32	Ruptured Disc Curettes .....	117		
Ruptured Disc Curettes .....	117	Ruskin Rongeurs .....	73		
Ruskin Rongeurs .....	73	Sachs Dura Hook.....	6		
Sachs Dura Hook.....	6	Sacral Blades, LumbarTrak....	37		
Sacral Blades, LumbarTrak....	37	Saw Blade Handles.....	2-3		
Saw Blade Handles.....	2-3	Saw Blades .....	4		
Saw Blades .....	4	Saw Guides .....	4		
Saw Guides .....	4	Saw Handles .....	2-3		
Saw Handles .....	2-3	Scalp Retractors .....	56		
Scalp Retractors .....	56	Scissors .....	183-190,		
Scissors .....	183-190,	.....	195-196,		
.....	195-196,	.....	203		
.....	203	Scissors, Bayonet .....	185-188,		
Scissors, Bayonet .....	185-188,	.....	190-191		
.....	190-191	Scissors, Dissecting.....	195, 203		
Scissors, Dissecting.....	195, 203	Scissors, Micro .....	183-190,		
Scissors, Micro .....	183-190,	.....	195-196		
.....	195-196	Scoville Nerve Root Retractor			
Scoville Nerve Root Retractor		.....	49		
.....	49	Scoville Retractor.....	28, 34		
Scoville Retractor.....	28, 34	Scoville Retractor, LumbarTrak			
Scoville Retractor, LumbarTrak		.....	34		
.....	34	Scoville Retractor, UMLD.....	28		
Scoville Retractor, UMLD.....	28	Scoville Ruptured Disc Curettes			
Scoville Ruptured Disc Curettes		.....	117		
.....	117	Scoville Type Hemilaminectomy Blades			
Scoville Type Hemilaminectomy Blades		.....	66		
.....	66	Scoville Type Hemilaminectomy Hooks			
Scoville Type Hemilaminectomy Hooks		.....	65		
.....	65	Scoville Type Hemilaminectomy Retractor Body .....	65		
Scoville Type Hemilaminectomy Retractor Body .....	65	Scoville-Greenwod Style Bipolar			
.....	65	Bayonet Forceps.....	173		
Scoville-Greenwod Style Bipolar		Screwdriver, ACF.....	22		
Bayonet Forceps.....	173	Screws .....	22, 35, 68		
Screwdriver, ACF.....	22	Self-Retaining Retractor Blade			
Screws .....	22, 35, 68	.....	66-67		
Self-Retaining Retractor Blade					
.....	66-67				



- .....32
- Spinal Retractors.....53
- Spinal Transverse Retractor Body  
.....32
- Spreaders, Lamina .....54
- Spreaders, Vertebral .....54
- Spurling Intervertebral Disc Rongeurs  
.....77-80,  
.....82-83
- Spurling Intervertebral Disc Rongeurs,  
Bayonet .....78-80
- Spurling Kerrison Rongeurs..94, 97, 101,  
.....106-107
- Spurling Kerrison Rongeurs, Bar Ejector  
.....107
- Square Retractor, LumbarTrak  
.....34
- Stainless Steel Kerrison Rongeurs  
.....103-109
- Stealth Ferris Smith Kerrison Rongeurs  
.....102
- Stealth Detach Kerrison Rongeurs  
.....98, 100
- Stealth Kerrison Rongeurs ....98-102
- Stealth Kerrison Rongeurs, Curved,  
Hingeless .....105
- Stealth Medium Kerrison Rongeurs,  
Detach .....100
- Stealth Micro Kerrison Rongeurs  
.....98-99
- Stealth Micro Kerrison Rongeurs,  
Detach .....98
- Stealth Micro Kerrison Rongeurs,  
Ejector .....98
- Stealth Spurling Kerrison Rongeurs  
.....101
- Stille-Horsley Rongeur .....70
- Stille-Luer Rongeurs.....72
- Strully-Gigli Handles .....3
- Styler, BUZZ .....182
- Suction Tubes.....128-138,  
.....203
- Suction Tubes with Multiple Holes  
.....132
- Suction Tubes, Atraumatic Tip  
.....132-134
- Suction Tubes, Fukushima ....137
- Suction Tubes, Teardrop .....134-138
- Supercutter .....76
- Suture Pusher .....148
- T. Fukushima Dura Spatulas..48
- T. Fukushima Dural Elevator and  
Spatulas.....16
- T. Fukushima Spatulas .....48
- T. Fukushima Tapered Teardrop Suction  
Tubes .....137
- Table Clamps .....39
- Tapered Teardrop Suction Tubes  
.....136-138
- Taylor Blades, UMLD .....29
- Taylor Spinal Retractors .....53
- Taylor Type Hemilaminectomy Blades  
.....67
- T-Bar Blades, UMLD.....29
- Teardrop Dissectors.....144, 146
- Teardrop Suction Tubes.....134-138
- Thin Blades, LumbarTrak.....36
- Thoraco-Lumbar Currettes ....118
- Thoraco-Lumbar Dissectors.118
- Tissue Forceps .....167
- Titanium Bayonet Scissors ...190
- Titanium Bipolar Bayonet Forceps  
.....174
- Titanium Dissection Instruments  
.....159-161
- Titanium Elevators.....160
- Titanium Forceps .....167
- Titanium Instruments .....35-37,  
.....159-161,  
.....167, 174,  
.....189-190,  
.....194
- Titanium Needle Holders.....194
- Titanium Retractor Blades ....36-37
- Titanium Scissors.....189-190
- Tongue Depressors .....40
- Toothed Hook Blades, McCulloch  
.....44
- Traction Tongs .....68
- Trans-Oral Clamps .....39
- Trans-Oral Lateral Retractor Clamp  
.....41
- Trans-Oral Mounting Arms...39
- Trans-Oral Mounting Rod Clamp  
.....39
- Trans-Oral Mouth Gag.....41
- Trans-Oral Palate Retractor Clamp  
.....41
- Trans-Oral Palate Retractors.  
.....40
- Trans-Oral Retraction System  
.....38-41
- Trans-Oral Retractor Tray .....41
- Trans-Oral Slotted Tongue Depressors  
.....40
- Trans-Oral Table Clamp .....39
- Trans-Oral Table Lateral Retractors  
.....40
- Trans-Oral Tongue Depressors  
.....40
- Transphenoidal Bayonet Currettes  
.....200, 201,  
.....202
- Transphenoidal Hypophysectomy  
Bipolar Bayonet Forceps.....171
- Transphenoidal Instruments  
.....199-202
- Transphenoidal Specula .....199
- Transverse Body Retractor ....23, 30, 32
- Transverse Body Retractor, ACF  
.....23
- Transverse Retractor Body, Flexi-Spine  
.....30
- Transverse Retractor Body, Spinal  
.....32
- Trays.....26, 30, 32,  
.....37, 41-43,  
.....110, 115,  
.....117, 123,  
.....142, 144,  
.....146, 149,  
.....151, 175,  
.....182, 187,  
.....203
- Trays, Apfelbaum Micro Dissection  
.....144, 146
- Trays, Bipolar .....175, 182
- Trays, Buzz .....182
- Trays, Currettes .....115, 117, 123
- Trays, Endoscopic Endonasal Pituitary  
.....203
- Trays, Flexi-Spine .....30
- Trays, Fukushima-Giannota Micro  
Instruments .....149
- Trays, Kerrison .....110
- Trays, LumbarTrak .....37
- Trays, McCulloch.....43
- Trays, Micro Bayonet Scissors  
.....187
- Trays, Rhoton Style Micro Dissection  
.....142
- Trays, Spinal Retraction System  
.....32

Trays, Trans-Oral .....	41	Weil-Blakesley Forceps.....	197, 203
Tumor Forceps.....	169	Weitlaner Retractors.....	61-62
Tungsten Carbide Forceps ....	168-169	Wide Blades .....	44
Twist Drill, ACF .....	22	Wide Blades, LumbarTrak ....	36
Twist Hooks .....	162	Wilde Intervertebral Disc Rongeurs .....	85
Ultra Nerve Hooks .....	124-125	Williams Style Micro Disc IVD Rongeurs .....	87
Ultra-Coat Bayonet Cushing IVD Rongeurs.....	79	Williams Type Discectomy Retractors .....	60
Ultra-Coat Bayonet Love-Gruenwald IVD Rongeurs.....	79	Wiltse-Gelpi Retractor .....	58
Ultra-Coat Bayonet Spurling IVD Rongeurs.....	79	Wire Cutter .....	76
Ultra-Coat Detach Kerrison Rongeurs .....	89, 93	Woodson Dura Separator and Packer .....	12
Ultra-Coat Flatback Curettes .....	113	Woodson Elevator .....	12
Ultra-Coat IVD Rongeurs .....	79	Woodson Elevator and Spatula .....	12
Ultra-Coat Kerrison Rongeurs .....	89-94	Woodson Packer .....	12
Ultra-Coat Medium Kerrison Rongeurs, Detach .....	93	Yasargil Bayonet Forceps.....	168-169
Ultra-Coat Micro Kerrison Rongeurs .....	89-91	Yasargil Bayonet Tumor Forceps .....	169
Ultra-Coat Micro Kerrison Rongeurs, Bayonet .....	92	Yasargil Forceps.....	166
Ultra-Coat Micro Kerrison Rongeurs, Detach .....	89	Yasargil Ligature Carrier.....	147
Ultra-Coat Micro Kerrison Rongeurs, Ejector .....	91, 92	Yasargil Micro Bayonet Needle Holders .....	193
Ultra-Coat Spinal Curettes.....	112-113	Yasargil Micro Bayonet Scissors .....	185-186
Ultra-Coat Spurling Kerrison Rongeurs .....	94	Yasargil Micro Instruments...157-158	
UMLD Retractor Blades.....	28-29	Yasargil Scissors .....	184
UMLD Scoville Retractor.....	28	Yasargil Style Bipolar Bayonet Forceps .....	173
UMLD Taylor Blades .....	29	Zaufel-Jansen Rongeur .....	74
UMLD T-Bar Blades.....	29		
Universal Micro Lumbar Discectomy (UMLD) Retraction System ...	28-29		
US Army Retractor .....	53		
Vein Retractor.....	52		
Vertebral Body Dissectors.....	25		
Vertebral Spreaders .....	54		
Vessel Knife.....	147		
Vessel Supporter .....	159		
Wave Intervertebral Disc Rongeurs .....	77		
Waxers, Bone .....	124-126		
Weary Nerve Hooks.....	163		



651301.....	159	N15So6.....	181	NBCLOTH.....	182
651302.....	159	N15S10.....	181	NBT10.....	182
651303.....	159	N15S12.....	180	NBT35.....	182
651304.....	159	N15S20.....	181	NH02.....	179
651305.....	159	N15SA03.....	181	NH04.....	179
651306.....	160	N15SA10.....	181	NH05.....	179
651307.....	160	N15SA20.....	181	NH07.....	179
651308.....	160	N17BLO3.....	182	NH10.....	179
651309.....	160	N17BLO6.....	182	NH13.....	179
651310.....	161	N17BL13.....	182	NH15.....	179
651311.....	161	N17BL17.....	182	NH17.....	179
651312.....	161	N18BSO3.....	177	NH20.....	179
651313.....	161	N18BSO6.....	177	NHAD02.....	179
651365.....	189	N18BS10.....	177	NHAD04.....	179
651366.....	189	N18BS20.....	177	NHAD05.....	179
651367.....	190	N18SO3.....	181	NHAD07.....	179
651368.....	190	N18SO6.....	181	NHAD10.....	179
651369.....	190	N18S10.....	181	NHAD13.....	179
651370.....	190	N18SA03.....	181	NHAD15.....	179
651371.....	190	N18SA06.....	181	NHAD17.....	179
651375.....	189	N18SA10.....	181	NHAD20.....	179
651376.....	189	N19Co7.....	178	NHAU02.....	179
651377.....	190	N19C12.....	178	NHAU04.....	179
651378.....	190	N19C15.....	178	NHAU05.....	179
651388.....	194	N20BAD10.....	177	NHAU07.....	179
651389.....	194	N20BAU10.....	177	NHAU10.....	179
651390.....	194	N20BSO3.....	177	NHAU13.....	179
651394.....	194	N20BSO6.....	177	NHAU15.....	179
651395.....	194	N20BS10.....	177	NHAU17.....	179
BUZZSTYLET.....	182	N20BS20.....	177	NHAU20.....	179
N10BLO3.....	182	N20S03.....	181	NHI10.....	179
N10BLO6.....	182	N20S10.....	181	NHI15.....	179
N10BL13.....	182	N20S20.....	181	NI15BS10.....	177
N10BL17.....	182	N20SA03.....	181	NI18BSO6.....	177
N11J025.....	180	N20SA10.....	181	NI18BS10.....	177
N11J06.....	180	N20SA20.....	181	NI19Co7.....	178
N11J10.....	180	N20SG03.....	178	NI19C12.....	178
N125A07.....	180	N20SG15.....	178	NI19C15.....	178
N125A12.....	180	N22BAD10.....	177	NI20SG10.....	178
N13BLO3.....	182	N22BAU10.....	177	NI20SG15.....	178
N13BLO6.....	182	N22BSO3.....	177	NI20SG20.....	178
N13BL13.....	182	N22BSO6.....	177	NI22BSO6.....	177
N13BL17.....	182	N22BS10.....	177	NI22BS10.....	177
N13BLA15.....	182	N22BS15.....	177	NI22BS20.....	177
N13BLA30.....	182	N22BS20.....	177	NL7702701.....	45
N13BLA45.....	182	N22So3.....	181	NL7702702.....	45
N15BLO3.....	182	N22S10.....	181	NL7702703.....	45
N15BLO6.....	182	N22S20.....	181	NL7702704.....	45
N15BL13.....	182	N22SA03.....	181	NL7702705.....	45
N15BL17.....	182	N22SA10.....	181	NL7702707.....	45
N15BSO3.....	177	N22SA20.....	181	NL7702708.....	45
N15BSO6.....	177	N24BSO3.....	177	NL8700200.....	45
N15BS10.....	177	N24BSO6.....	177	NL8700204.....	45
N15BS20.....	177	N24BS10.....	177	NL8700206.....	45
N15So3.....	181	N24BS20.....	177	NL8700208.....	45

NL8700210 .....	45	Ro660.....	131	Ro930 .....	47
NL8700214.....	45	Ro661.....	131	Ro930A.....	47
NRBC118 .....	182	Ro662.....	131	R1000 .....	49
Ro175 .....	10	Ro663.....	131	R1005.....	49
Ro176 .....	10	Ro664.....	131	R1007.....	49
Ro177 .....	10	Ro674.....	132	R1024.....	50
Ro178 .....	10	Ro675.....	132	R1025.....	50
Ro200.....	6	Ro676.....	132	R1026.....	50
Ro205.....	6	Ro677.....	132	R1027.....	50
Ro212.....	7	Ro678.....	132	R1050.....	54
Ro231.....	9	Ro679.....	132	R1054.....	54
Ro233.....	9	Ro680.....	132	R1060.....	53
Ro240.....	10	Ro681.....	132	R1061.....	53
Ro243.....	10	Ro682.....	132	R1062.....	53
Ro244.....	10	Ro707.....	130	R1070.....	55
Ro260.....	13	Ro708.....	130	R1075.....	55
Ro261.....	13	Ro710.....	130	R1093.....	53
Ro262.....	13	Ro711.....	130	R1095.....	52
Ro263.....	13	Ro712.....	130	R1100.....	52
Ro265.....	12	Ro713.....	130	R1106.....	65
Ro267.....	12	Ro714.....	130	R1111.....	65
Ro268.....	12	Ro715.....	130	R1113.....	65
Ro269.....	13	Ro716.....	130	R1114.....	65
Ro285.....	14	Ro770.....	130	R1115.....	65
Ro286.....	14	Ro771.....	130	R1116.....	65
Ro289.....	14	Ro772.....	130	R1118.....	66
Ro290.....	14	Ro773.....	130	R1119.....	66
Ro291.....	14	Ro774.....	130	R1120.....	66
Ro294.....	17	Ro775.....	130	R1121.....	66
Ro295.....	13	Ro776.....	130	R1123.....	66
Ro296.....	17	Ro777.....	130	R1124.....	66
Ro297.....	17	Ro778.....	130	R1126.....	66
Ro298.....	17	Ro785.....	131	R1127.....	66
Ro299.....	17	Ro786.....	131	R1128.....	66
Ro360B.....	114	Ro787.....	131	R1130.....	67
Ro361B.....	114	Ro788.....	131	R1131.....	67
Ro362B.....	114	Ro789.....	131	R1134.....	67
Ro363B.....	114	Ro790.....	131	R1135.....	67
Ro364B.....	114	Ro791.....	131	R1136.....	67
Ro365B.....	114	Ro848.....	8	R1137.....	67
Ro366B.....	114	Ro860.....	8	R1138.....	67
Ro367B.....	114	Ro861.....	8	R1139.....	67
Ro368B.....	114	Ro862.....	8	R1140.....	67
Ro435.....	168	Ro924.....	47	R1142.....	67
Ro437.....	168	Ro924A.....	47	R1143.....	67
Ro439.....	168	Ro925.....	47	R1144.....	67
Ro440.....	168	Ro925A.....	47	R1145.....	67
Ro442.....	168	Ro926.....	47	R1146.....	67
Ro455.....	167	Ro926A.....	47	R1147.....	67
Ro462.....	167	Ro927.....	47	R1148.....	67
Ro515.....	5	Ro927A.....	47	R1149.....	67
Ro520.....	5	Ro928.....	47	R1155.....	56
Ro521.....	5	Ro928A.....	47	R1165.....	64
Ro658.....	131	Ro929.....	47	R1166.....	64
Ro659.....	131	Ro929A.....	47	R1170.....	64

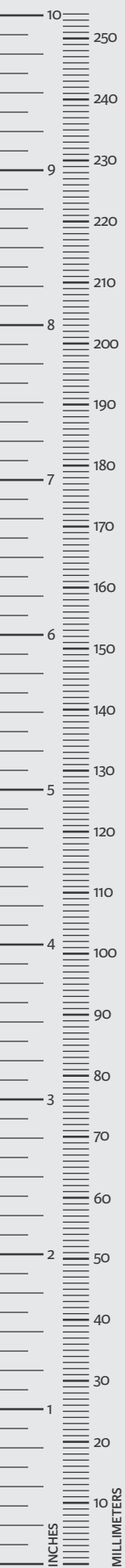



R1175 .....	64	R1388 .....	72	R18402 .....	86
R1189 .....	63	R1390 .....	75	R18403 .....	86
R1190 .....	63	R1391 .....	75	R18404 .....	86
R1194 .....	63	R1392 .....	75	R18405 .....	86
R1195 .....	63	R1587 .....	108	R18453 .....	86
R1197 .....	63	R1591 .....	108	R18454 .....	86
R1200 .....	61	R1593 .....	108	R18455 .....	86
R1201 .....	61	R1596 .....	108	R18503 .....	86
R1205 .....	61	R1635 .....	104	R18504 .....	86
R1206 .....	61	R1636 .....	104	R18615 .....	84
R1208 .....	62	R1637 .....	104	R18625 .....	84
R1209 .....	62	R1638 .....	104	R18635 .....	84
R1210 .....	61	R16403 .....	107	R1925 .....	195
R1211 .....	61	R16404 .....	107	R1942 .....	68
R1215 .....	61	R16405 .....	107	R1945 .....	68
R1216 .....	61	R16702 .....	105	R1946 .....	68
R1217 .....	62	R16703 .....	105	R1947 .....	68
R1218 .....	62	R16703L .....	105	R1947SL .....	68
R1220 .....	61	R16703R .....	105	R1949 .....	68
R1221 .....	61	R16704 .....	105	R2000 .....	117
R1225 .....	61	R16705 .....	105	R2001 .....	117
R1226 .....	61	R16706 .....	105	R2002 .....	117
R1230 .....	61	R1711 .....	85	R2003 .....	117
R1231 .....	61	R1711L .....	85	R2004 .....	117
R1272 .....	58	R1712 .....	85	R2005 .....	117
R1273 .....	58	R1712L .....	85	R2006 .....	117
R1275 .....	58	R1713 .....	85	R2007 .....	117
R1280 .....	58	R1713L .....	85	R2008 .....	117
R1285 .....	58	R1714 .....	85	R2010 .....	117
R1290 .....	58	R1714L .....	85	R2011 .....	117
R1297 .....	52	R1716 .....	85	R2012 .....	117
R1298 .....	52	R1716L .....	85	R2013 .....	117
R1300 .....	70	R1717 .....	85	R2014 .....	117
R1307 .....	70	R1717L .....	85	R2015 .....	117
R1324 .....	71	R1718 .....	85	R2016 .....	117
R1325 .....	71	R1718L .....	85	R2017 .....	117
R1326 .....	71	R1719 .....	85	R2018 .....	117
R1327 .....	71	R1719L .....	85	R2200 .....	18
R1330 .....	71	R1722 .....	84	R2201 .....	18
R1338 .....	73	R1723 .....	84	R2202 .....	18
R1339 .....	73	R1724 .....	84	R2203 .....	18
R1340 .....	73	R1745 .....	87	R2204 .....	18
R1341 .....	73	R1758 .....	82	R2205 .....	18
R1342 .....	73	R1759 .....	82	R2210 .....	18
R1343 .....	73	R1765 .....	84	R2211 .....	18
R1344 .....	73	R1766 .....	84	R2212 .....	18
R1350 .....	74	R1767 .....	84	R2213 .....	18
R1355 .....	74	R1785 .....	84	R2214 .....	18
R1370 .....	74	R1786 .....	84	R2215 .....	18
R1375 .....	74	R1787 .....	84	R2220 .....	119
R1380 .....	74	R18045 .....	84	R2221 .....	119
R1381 .....	72	R18055 .....	84	R2222 .....	119
R1382 .....	72	R18065 .....	84	R2223 .....	119
R1383 .....	72	R18165 .....	84	R2224 .....	119
R1386 .....	72	R18175 .....	84	R2225 .....	119
R1387 .....	72	R18185 .....	84	R2226 .....	119





R2227.....	119	R2843.....	116	R6315.....	25
R2228.....	119	R2844.....	116	R6316.....	25
R2230.....	119	R2845.....	116	R6317.....	24
R2231.....	119	R2846.....	116	R6318.....	25
R2232.....	119	R2847.....	116	R6319.....	25
R2233.....	119	R2848.....	116	R6320.....	24
R2234.....	119	R2849.....	116	R6321.....	24
R2235.....	119	R2850.....	116	R6322.....	51
R2236.....	119	R2851.....	116	R6323.....	51
R2237.....	119	R2852.....	116	R6324.....	51
R2238.....	119	R2853.....	116	R6337.....	25
R2620.....	171	R2854.....	116	R6367A.....	22
R2640.....	170	R2855.....	116	R6370.....	23
R2645.....	170	R2856.....	116	R6371.....	23
R2646.....	170	R2857.....	116	R6372.....	23
R2691.....	174	R2858.....	116	R6373.....	23
R2692.....	174	R2859.....	116	R6374.....	23
R2693.....	174	R2860.....	123	R6375.....	24
R2694.....	174	R2861.....	123	R6376.....	24
R2696.....	171	R2862.....	123	R6377.....	24
R2697.....	171	R2863.....	123	R6378.....	24
R2698.....	171	R2864.....	123	R6379.....	24
R2799.....	116	R2865.....	123	R6381.....	23
R2800.....	42	R2866.....	123	R6382.....	23
R2800.....	116	R2867.....	123	R6383.....	23
R2801.....	42	R2868.....	123	R6384.....	23
R2801.....	116	R2870.....	123	R6385.....	23
R2802.....	116	R2871.....	123	R6387.....	22
R2803.....	116	R2872.....	123	R6388.....	22
R2804.....	116	R2873.....	123	R6389.....	22
R2805.....	116	R2874.....	123	R6390.....	25
R2806.....	116	R2875.....	123	R6391.....	25
R2807.....	116	R2876.....	123	R6392.....	22
R2808.....	116	R2877.....	123	R6393.....	22
R2809.....	116	R2878.....	123	R6394.....	22
R2810.....	116	R2881.....	123	R6396.....	22
R2819.....	116	R2882.....	123	R6397A.....	22
R2820.....	42	R2883.....	123	R6398A.....	22
R2820.....	116	R2884.....	123	R6399.....	25
R2821.....	42	R2885.....	123	R6405.....	27
R2821.....	116	R2886.....	123	R6407.....	27
R2822.....	116	R2891.....	123	R6408.....	27
R2823.....	116	R2892.....	123	R6409.....	27
R2824.....	116	R2893.....	123	R6410.....	27
R2825.....	116	R2894.....	123	R6411.....	27
R2826.....	116	R2895.....	123	R6412.....	27
R2827.....	116	R2896.....	123	R6413.....	27
R2828.....	116	R3320.....	76	R6414.....	27
R2829.....	116	R3321.....	76	R6415.....	27
R2830.....	116	R3325.....	76	R6416.....	27
R2839.....	116	R6000.....	22	R6417.....	27
R2840.....	42	R6298.....	26	R6418.....	27
R2840.....	116	R6310.....	18, 21, 22	R6506.....	118
R2841.....	42	R6312.....	23	R6507.....	118
R2841.....	116	R6313.....	23	R6510.....	118
R2842.....	116	R6314.....	25	R6511.....	118

R6512 .....	118	R7252 .....	60	R8410 .....	147
R6513 .....	118	R7253 .....	60	R8411 .....	148
R6514 .....	118	R7254 .....	60	R8412 .....	148
R6515 .....	118	R7255 .....	60	R8413 .....	148
R6516 .....	118	R7260 .....	60	R8414 .....	148
R6517 .....	118	R7261 .....	60	R8415 .....	148
R6518 .....	118	R7262 .....	60	R8416 .....	148
R6519 .....	118	R7263 .....	60	R8445 .....	165
R6520 .....	118	R7264 .....	60	R8645 .....	196
R6521 .....	118	R7265 .....	60	R8646 .....	196
R6523 .....	117	R7305 .....	164	R8647 .....	196
R6540 .....	20	R7306 .....	164	R8850 .....	196
R6541 .....	20	R7307 .....	164	R8851 .....	196
R6542 .....	20	R7308 .....	164	R8852 .....	196
R6543 .....	20	R7309 .....	164	R8855 .....	196
R6544 .....	20	R7310 .....	164	R8856 .....	196
R6545 .....	20	R7315 .....	164	R8857 .....	196
R6546 .....	20	R7316 .....	164	R8858 .....	196
R6547 .....	20	R7317 .....	164	R8860 .....	196
R6548 .....	20	R7318 .....	164	R8861 .....	196
R6550 .....	23	R7320 .....	165	R8862 .....	196
R6551 .....	23	R7321 .....	165	R8865 .....	200
R6552 .....	23	R7350 .....	121	R8866 .....	200
R6553 .....	23	R7351 .....	121	R8867 .....	200
R6554 .....	23	R7352 .....	121	R8868 .....	200
R6555 .....	23	R7353 .....	121	R8869 .....	200
R6556 .....	23	R7360 .....	121	R8870 .....	200
R6557 .....	23	R7361 .....	121	R8871 .....	200
R6558 .....	23	R7362 .....	121	R8872 .....	200
R6559 .....	23	R7363 .....	121	R8873 .....	200
R6560 .....	24	R7365 .....	121	R8874 .....	200
R6561 .....	24	R7366 .....	121	R8875 .....	200
R6562 .....	24	R7367 .....	121	R8876 .....	153
R6563 .....	24	R7368 .....	121	R8877 .....	153
R6564 .....	24	R7370 .....	121	R8878 .....	153
R6579 .....	28	R7371 .....	121	R8879 .....	153
R6601 .....	28	R7372 .....	121	R8880 .....	154
R6602 .....	28	R7373 .....	121	R8881 .....	153
R6603 .....	28	R7401 .....	199	R8882 .....	155
R6604 .....	28	R7402 .....	199	R8883 .....	155
R6621 .....	29	R7403 .....	199	R8884 .....	155
R6622 .....	29	R8113 .....	115, 123	R8885 .....	155
R6623 .....	29	R8114 .....	115, 123	R8886 .....	155
R6624 .....	29	R8210 .....	192	R8887 .....	154
R6630 .....	28	R8230 .....	166	R8888 .....	154
R6631 .....	28	R8231 .....	166	R8889 .....	156
R6632 .....	28	R8234 .....	163	R8890 .....	156
R6633 .....	28	R8235 .....	163	R8891 .....	156
R6640 .....	29	R8250 .....	166	R8906 .....	15
R6641 .....	29	R8251 .....	166	R8907 .....	15
R6642 .....	29	R8401 .....	147	R8908 .....	15
R6643 .....	29	R8402 .....	147	R8909 .....	15
R6644 .....	29	R8403 .....	147	R8911 .....	16
R7250 .....	60	R8408 .....	147	R8912 .....	16
R7251 .....	60	R8409 .....	147	R8924 .....	188



R8925.....	188	R8983SM.....	138	R9019SM.....	138
R8926.....	188	R8984.....	137	R9020SM.....	138
R8927.....	188	R8984SM.....	138	R9021SM.....	138
R8928.....	188	R8985.....	137	R9042.....	137
R8929.....	188	R8985SM.....	138	R9042SM.....	138
R8930.....	188	R8986.....	137	R9043.....	137
R8931.....	188	R8986SM.....	138	R9043SM.....	138
R8931S.....	188	R8987.....	137	R9044.....	137
R8932.....	188	R8987SM.....	138	R9044SM.....	138
R8933.....	188	R8988.....	137	R9045.....	137
R8934.....	188	R8988SM.....	138	R9045SM.....	138
R8935.....	149	R8989.....	137	R9046.....	137
R8936.....	149	R8989SM.....	138	R9046SM.....	138
R8937.....	149	R8990.....	137	R9047.....	137
R8938.....	149	R8990SM.....	138	R9047SM.....	138
R8939.....	149	R8991.....	137	R9395.....	22
R8940.....	149	R8991SM.....	138	RB1063.....	4
R8941.....	149	R8992.....	137	RB1109.....	8
R8942.....	150	R8992SM.....	138	RB1110.....	8
R8943.....	150	R8993.....	137	RB1150T.....	167
R8944.....	150	R8993SM.....	138	RB1154T.....	167
R8945.....	150	R8994.....	137	RB1174T.....	167
R8946.....	151	R8994SM.....	138	RB1175T.....	167
R8947.....	151	R8995.....	137	RB1453.....	18
R8948.....	151	R8995SM.....	138	RB1454.....	18
R8949.....	151	R8996.....	137	RB1455.....	18
R8950.....	151	R8996SM.....	138	RB1456.....	18
R8951.....	151	R8997.....	137	RB1457.....	18
R8952.....	151	R8997SM.....	138	RB1458.....	18
R8953.....	152	R8998.....	48	RB1459.....	18
R8954.....	150	R8999.....	48	RB1460.....	18
R8955.....	150	R9000.....	137	RB1461.....	18
R8956.....	152	R9000SM.....	138	RB1462.....	18
R8958.....	152	R9001.....	137	RB1463.....	18
R8959.....	48	R9001SM.....	138	RB1464.....	18
R8960.....	48	R9002.....	137	RB1465.....	18
R8961.....	48	R9002SM.....	138	RB1466.....	18
R8962.....	48	R9003.....	137	RB1467.....	18
R8963.....	48	R9004.....	137	RB1468.....	18
R8964.....	48	R9005.....	137	RB1469.....	18
R8965.....	137	R9006.....	137	RB1470.....	18
R8966.....	137	R9007.....	137	RB1471.....	18
R8967.....	137	R9007SM.....	138	RB1472.....	18
R8968.....	137	R9008.....	137	RB1543.....	17
R8969.....	137	R9008SM.....	138	RB1544.....	17
R8970.....	137	R9009.....	137	RB1545.....	17
R8977.....	149	R9009SM.....	138	RB1546.....	17
R8979.....	48	R9010.....	137	RB1547.....	17
R8980.....	137	R9012SM.....	138	RB1695.....	19
R8980SM.....	138	R9013SM.....	138	RB2002.....	71
R8981.....	137	R9014SM.....	138	RB2014.....	73
R8981SM.....	138	R9015SM.....	138	RB2015.....	73
R8982.....	137	R9016SM.....	138	RB2047.....	73
R8982SM.....	138	R9017SM.....	138	RB2064.....	70
R8983.....	137	R9018SM.....	138	RB2065.....	70

RB2066.....	70	RB2601B.....	34	RB2672.....	40
RB2067.....	70	RB2602.....	34	RB2673.....	40
RB2068.....	70	RB2603.....	35	RB2674.....	40
RB2069.....	70	RB2604.....	35	RB2675.....	40
RB2070.....	70	RB2604S.....	35	RB2676.....	40
RB2071.....	70	RB2605.....	35	RB2677.....	40
RB2120.....	43	RB2606.....	35	RB2678.....	40
RB2121.....	43	RB2609.....	35	RB2679.....	41
RB2122.....	44	RB2610.....	36	RB2680.....	41
RB2123.....	44	RB2611.....	36	RB2690.....	42
RB2124.....	44	RB2612.....	36	RB3892.....	109
RB2125.....	44	RB2613.....	36	RB3894.....	109
RB2126.....	44	RB2614.....	36	RB3895.....	109
RB2127.....	44	RB2615.....	36	RB41022.....	101
RB2128.....	44	RB2616.....	36	RB41023.....	101
RB2129.....	44	RB2617.....	36	RB41024.....	101
RB2130.....	44	RB2618.....	36	RB41025.....	101
RB2131.....	44	RB2620.....	36	RB41026.....	101
RB2132.....	44	RB2621.....	36	RB41051.....	96
RB2133.....	44	RB2622.....	36	RB41052.....	96
RB2140.....	44	RB2623.....	36	RB41053.....	96
RB2141.....	44	RB2624.....	36	RB41054.....	96
RB2142.....	44	RB2625.....	36	RB41055.....	96
RB2143.....	44	RB2626.....	36	RB41056.....	96
RB2144.....	44	RB2627.....	36	RB41091.....	96
RB2145.....	44	RB2628.....	36	RB41122.....	101
RB2147.....	44	RB2629.....	36	RB41123.....	101
RB2148.....	44	RB2630.....	36	RB41124.....	101
RB2149.....	44	RB2631.....	36	RB41125.....	101
RB2150.....	44	RB2632.....	36	RB41126.....	101
RB2151.....	44	RB2633.....	36	RB41151.....	96
RB2152.....	44	RB2640.....	37	RB41152.....	96
RB2252.....	64	RB2641.....	37	RB41153.....	96
RB2286.....	58	RB2642.....	37	RB41154.....	96
RB2304.....	53	RB2643.....	37	RB41155.....	96
RB2305.....	53	RB2644.....	37	RB41156.....	96
RB2306.....	53	RB2645.....	37	RB41191.....	96
RB2308.....	54	RB2646.....	37	RB4719.....	102
RB2375.....	24	RB2647.....	37	RB4720.....	102
RB2471.....	26	RB2648.....	37	RB4721M.....	100
RB2472.....	26	RB2656.....	42	RB4722.....	101
RB2473.....	26	RB2657.....	42	RB4722M.....	100
RB2474.....	26	RB2658.....	42	RB4723.....	101
RB2475.....	26	RB2659.....	42	RB4723M.....	100
RB2481.....	26	RB2660.....	38	RB4724.....	101
RB2482.....	26	RB2661.....	39	RB4724M.....	100
RB2483.....	26	RB2662.....	39	RB4725.....	101
RB2484.....	26	RB2663.....	39	RB4725M.....	100
RB2485.....	26	RB2664.....	39	RB4726.....	101
RB2491.....	26	RB2665.....	40	RB4726M.....	100
RB2492.....	26	RB2666.....	40	RB4751.....	99
RB2493.....	26	RB2667.....	40	RB4751M.....	100
RB2494.....	26	RB2668.....	40	RB4752.....	99
RB2495.....	26	RB2669.....	40	RB4753.....	99
RB2549.....	56	RB2670.....	40	RB4754.....	99
RB2600.....	34	RB2671.....	41	RB4755.....	99



RB4756 .....	99	RB4874D .....	102	RB5562 .....	92
RB4771 .....	99	RB4875D .....	102	RB5563 .....	92
RB4802 .....	101	RB4882 .....	99	RB5564 .....	92
RB4803 .....	101	RB4882DT .....	98	RB5565 .....	92
RB4804 .....	101	RB4890 .....	99	RB5566 .....	92
RB4805 .....	101	RB4891 .....	99	RB5582 .....	92
RB4806 .....	101	RB4891DT .....	98	RB5583 .....	92
RB4812 .....	101	RB4892 .....	99	RB5584 .....	92
RB4813 .....	101	RB4892E .....	98	RB5585 .....	92
RB4814 .....	101	RB4893 .....	98	RB5586 .....	92
RB4815 .....	101	RB4894 .....	98	RB5662 .....	92
RB4816 .....	101	RB4895 .....	98	RB5663 .....	92
RB4821DTM .....	100	RB4896 .....	98	RB5664 .....	92
RB4821M .....	100	RB4922 .....	101	RB5665 .....	92
RB4822 .....	101	RB4923 .....	101	RB5666 .....	92
RB4822DTM .....	100	RB4924 .....	101	RB5760 .....	90
RB4822M .....	100	RB4925 .....	101	RB5760DT .....	89
RB4823 .....	101	RB4926 .....	101	RB5761 .....	90
RB4823DTM .....	100	RB4951 .....	96	RB5762 .....	90
RB4823M .....	100	RB4952 .....	96	RB5762DT .....	89
RB4824 .....	101	RB4953 .....	96	RB5763DT .....	89
RB4824DTM .....	100	RB4954 .....	96	RB5763X .....	90
RB4824M .....	100	RB4955 .....	96	RB5764DT .....	89
RB4825 .....	101	RB4956 .....	96	RB5764X .....	90
RB4825DTM .....	100	RB4991 .....	96	RB5765 .....	90
RB4825M .....	100	RB5062 .....	90	RB5765DT .....	89
RB4826 .....	101	RB5063 .....	90	RB5766 .....	90
RB4826M .....	100	RB5064 .....	90	RB5766DT .....	89
RB4833 .....	99	RB5065 .....	90	RB5772 .....	94
RB4834 .....	99	RB5066 .....	90	RB5773 .....	94
RB4835 .....	99	RB5072 .....	94	RB5774 .....	94
RB4836 .....	99	RB5073 .....	94	RB5775 .....	94
RB4843 .....	96	RB5074 .....	94	RB5776 .....	94
RB4844 .....	96	RB5075 .....	94	RB5860 .....	90
RB4845 .....	96	RB5076 .....	94	RB5860DT .....	89
RB4846 .....	96	RB5160DT .....	89	RB5860DTM .....	93
RB4851 .....	99	RB5162 .....	90	RB5860M .....	93
RB4851M .....	100	RB5162DT .....	89	RB5861 .....	90
RB4853 .....	99	RB5163 .....	90	RB5862 .....	90
RB4853DT .....	98	RB5163DT .....	89	RB5862DT .....	89
RB4854 .....	99	RB5164 .....	90	RB5862DTM .....	93
RB4854DT .....	98	RB5164DT .....	89	RB5862M .....	93
RB4855 .....	99	RB5165 .....	90	RB5863 .....	90
RB4855DT .....	98	RB5165DT .....	89	RB5863DT .....	89
RB4856 .....	99	RB5166 .....	90	RB5863DTM .....	93
RB4856DT .....	98	RB5166DT .....	89	RB5863M .....	93
RB4860 .....	99	RB5172 .....	94	RB5864 .....	90
RB4861 .....	99	RB5173 .....	94	RB5864DT .....	89
RB4862 .....	99	RB5174 .....	94	RB5864DTM .....	93
RB4863 .....	99	RB5175 .....	94	RB5864M .....	93
RB4864 .....	99	RB5176 .....	94	RB5865 .....	90
RB4865 .....	99	RB5362 .....	90	RB5865DT .....	89
RB4866 .....	99	RB5363 .....	90	RB5865DTM .....	93
RB4872 .....	96	RB5364 .....	90	RB5865M .....	93
RB4872D .....	102	RB5365 .....	90	RB5866 .....	90
RB4873D .....	102	RB5366 .....	90	RB5866DT .....	89

RB5866DTM .....	93	RB6602.....	80	RB7731 .....	112
RB5866M .....	93	RB6603.....	80	RB7732.....	112
RB5872.....	94	RB6604.....	80	RB7733.....	112
RB5873.....	94	RB6605.....	80	RB7734.....	112
RB5874.....	94	RB6606.....	80	RB7735.....	112
RB5875.....	94	RB6621.....	80	RB7736.....	112
RB5876.....	94	RB6622.....	80	RB7737.....	112
RB5882.....	91	RB6623.....	80	RB7738.....	112
RB5883.....	91	RB6641.....	80	RB7739.....	112
RB5884.....	91	RB6642.....	80	RB7740.....	112
RB5885.....	91	RB6643.....	80	RB7741.....	112
RB5960.....	90	RB6801.....	79	RB7742.....	112
RB5960DT.....	89	RB6802.....	79	RB7743.....	112
RB5961.....	90	RB6803.....	79	RB7744.....	112
RB5962.....	90	RB6804.....	79	RB7745.....	113
RB5962DT.....	89	RB6805.....	79	RB7746.....	113
RB5963.....	90	RB6806.....	79	RB7747.....	113
RB5963DT.....	89	RB6821.....	79	RB7748.....	113
RB5964.....	90	RB6822.....	79	RB7749.....	113
RB5964DT.....	89	RB6823.....	79	RB7750.....	113
RB5965.....	90	RB6841.....	79	RB7751.....	113
RB5965DT.....	89	RB6842.....	79	RB7752.....	113
RB5966.....	90	RB6843.....	79	RB7753.....	113
RB5966DT.....	89	RB7170.....	116	RB7754.....	113
RB5972.....	94	RB7181.....	116	RB7755.....	113
RB5973.....	94	RB7281.....	116	RB7756.....	113
RB5974.....	94	RB7701.....	112	RB7757.....	113
RB5975.....	94	RB7702.....	112	RB7758.....	113
RB5976.....	94	RB7703.....	112	RB7759.....	113
RB6126.....	84	RB7704.....	112	RB7760.....	113
RB6154.....	87	RB7705.....	112	RB7761.....	113
RB6155.....	87	RB7706.....	112	RB7762.....	113
RB6246.....	81	RB7707.....	112	RB7763.....	113
RB6247.....	81	RB7708.....	112	RB7764.....	113
RB6248.....	81	RB7709.....	112	RB7765.....	113
RB6249.....	82	RB7710.....	112	RB7766.....	113
RB6250.....	82	RB7711.....	112	RB7767.....	113
RB6251.....	82	RB7712.....	112	RB7768.....	113
RB6252.....	83	RB7713.....	112	RB7769.....	113
RB6253.....	83	RB7714.....	112	RB7770.....	113
RB6254.....	83	RB7715.....	112	RB7771.....	113
RB6307.....	83	RB7716.....	112	RB7772.....	113
RB6308.....	83	RB7717.....	112	RB7773.....	113
RB6309.....	83	RB7718.....	112	RB7774.....	113
RB6401.....	86	RB7719.....	112	RB7775.....	113
RB6402.....	86	RB7720.....	112	RB7776.....	113
RB6403.....	86	RB7721.....	112	RB7777.....	113
RB6404.....	86	RB7722.....	112	RB7801.....	112
RB6405.....	86	RB7723.....	112	RB7802.....	112
RB6406.....	86	RB7724.....	112	RB7803.....	112
RB6407.....	86	RB7725.....	112	RB7804.....	112
RB6408.....	86	RB7726.....	112	RB7805.....	112
RB6409.....	86	RB7727.....	112	RB7806.....	112
RB6410.....	86	RB7728.....	112	RB7807.....	112
RB6415.....	86	RB7729.....	112	RB7808.....	112
RB6601.....	80	RB7730.....	112	RB7809.....	112



RB7810.....	112	RB7948 .....	113	RB9187 .....	167
RB7811.....	112	RB7949 .....	113	RB9188.....	167
RB7812.....	112	RB7950 .....	113	RB9221.....	170
RB7813.....	112	RB7951 .....	113	RB9222.....	170
RB7814.....	112	RB7960.....	113	RB9224.....	170
RB7815.....	112	RB7961.....	113	RB9227.....	171
RB7816.....	112	RB7962.....	113	RB9228.....	176
RB7817.....	112	RB7963.....	113	RB9229.....	176
RB7818.....	112	RB7964.....	113	RB9230.....	176
RB7819.....	112	RB7965.....	113	RB9231.....	176
RB7820.....	112	RB7966.....	113	RB9232.....	176
RB7821.....	112	RB7967.....	113	RB9233.....	172
RB7822.....	112	RB7968.....	113	RB9235.....	173
RB7823.....	112	RB7969.....	113	RB9236.....	173
RB7824.....	112	RB7970.....	113	RB9241.....	173
RB7825.....	112	RB7971.....	113	RB9242.....	173
RB7826.....	112	RB8631.....	137	RB9243.....	171
RB7827.....	112	RB8731.....	137	RB9250.....	193
RB7828.....	112	RB8800737.....	204	RB9251.....	193
RB7829.....	112	RB8800738.....	204	RB9252.....	193
RB7830.....	112	RB8800739.....	204	RB9253.....	193
RB7831.....	112	RB8831.....	137	RB9339.....	158
RB7832.....	112	RB8951.....	184	RB9340.....	158
RB7833.....	112	RB8952.....	184	RB9341.....	158
RB7900.....	113	RB9006.....	184	RB9342.....	158
RB7901.....	113	RB9008.....	184	RB9343.....	158
RB7902.....	113	RB9010.....	184	RB9344.....	157
RB7903.....	113	RB9011.....	184	RB9345.....	157
RB7904.....	113	RB9022.....	184	RB9346.....	157
RB7905.....	113	RB9023.....	184	RB9347.....	157
RB7906.....	113	RB9110.....	186	RB9348.....	157
RB7907.....	113	RB9111.....	186	RB9617.....	197
RB7908.....	113	RB9112.....	186	RB9618.....	197
RB7909.....	113	RB9113.....	186	RB9619.....	197
RB7910.....	113	RB9114.....	186	RBG4027.....	42
RB7911.....	113	RB9115.....	186	RBT1001.....	110
RB7920.....	113	RB9116.....	186	RBT1002.....	115
RB7921.....	113	RB9120.....	186	RBT2120.....	43
RB7922.....	113	RB9121.....	186	RBT2600.....	37
RB7923.....	113	RB9122.....	186	RBT2660.....	41
RB7924.....	113	RB9123.....	186	RBT2690.....	42
RB7925.....	113	RB9124.....	186	RD41191DT.....	95
RB7926.....	113	RB9125.....	186	RD41192.....	95
RB7927.....	113	RB9126.....	186	RD41192DT.....	95
RB7928.....	113	RB9127.....	186	RD41193.....	95
RB7929.....	113	RB9128.....	186	RD41193DT.....	95
RB7930.....	113	RB9129.....	184	RD41194.....	95
RB7931.....	113	RB9137.....	168	RD41194DT.....	95
RB7940.....	113	RB9138.....	168	RD41195.....	95
RB7941.....	113	RB9139.....	168	RD41195DT.....	95
RB7942.....	113	RB9140.....	168	RD41196.....	95
RB7943.....	113	RB9141.....	168	RD41196DT.....	95
RB7944.....	113	RB9142.....	168	RD4722.....	97
RB7945.....	113	RB9143.....	168	RD4723.....	97
RB7946.....	113	RB9144.....	168	RD4724.....	97
RB7947.....	113	RB9145.....	168	RD4725.....	97

RD4726 .....	97	RD5666 .....	97	RNo077 .....	3
RD4751 .....	95	RD6811 .....	78	RNo120 .....	6
RD4752 .....	95	RD6812 .....	78	RNo1200 .....	114
RD4752DT .....	95	RD6813 .....	78	RNo1201 .....	114
RD4753 .....	95	RD6814 .....	78	RNo1202 .....	114
RD4753DT .....	95	RD6815 .....	78	RNo1203 .....	114
RD4754 .....	95	RD6816 .....	78	RNo1204 .....	114
RD4754DT .....	95	RD6831 .....	78	RNo1205 .....	114
RD4755 .....	95	RD6832 .....	78	RNo1206 .....	114
RD4755DT .....	95	RD6833 .....	78	RNo1207 .....	114
RD4756 .....	95	RD6851 .....	78	RNo1208 .....	114
RD4756DT .....	95	RD6852 .....	78	RNo1209 .....	114
RD4771 .....	95	RD6853 .....	78	RNo1210 .....	114
RD4771DT .....	95	REo800 .....	114	RNo1220 .....	114
RD4821DTM .....	96	REo801 .....	114	RNo1221 .....	114
RD4821M .....	101	REo802 .....	114	RNo1222 .....	114
RD4822 .....	97	REo803 .....	114	RNo1223 .....	114
RD4822DTM .....	96	REo804 .....	114	RNo1224 .....	114
RD4822M .....	101	REo805 .....	114	RNo1225 .....	114
RD4823 .....	97	REo806 .....	114	RNo1226 .....	114
RD4823DTM .....	96	REo807 .....	114	RNo1227 .....	114
RD4823M .....	101	REo808 .....	114	RNo1228 .....	114
RD4824 .....	97	REo809 .....	114	RNo1229 .....	114
RD4824DTM .....	96	REo810 .....	114	RNo123 .....	8
RD4824M .....	101	REo820 .....	114	RNo1230 .....	114
RD4825 .....	97	REo821 .....	114	RNo124 .....	8
RD4825DTM .....	96	REo822 .....	114	RNo1248 .....	115
RD4825M .....	101	REo823 .....	114	RNo1249 .....	115
RD4826 .....	97	REo824 .....	114	RNo1250 .....	115
RD4826DTM .....	96	REo825 .....	114	RNo1251 .....	115
RD4826M .....	101	REo826 .....	114	RNo1252 .....	115
RD4851 .....	95	REo827 .....	114	RNo1253 .....	115
RD4851M .....	101	REo828 .....	114	RNo1254 .....	115
RD4853 .....	95	REo829 .....	114	RNo1255 .....	115
RD4853DT .....	95	REo830 .....	114	RNo1256 .....	115
RD4854 .....	95	REo848 .....	115	RNo1257 .....	115
RD4854DT .....	95	REo849 .....	115	RNo1258 .....	115
RD4855 .....	95	REo850 .....	115	RNo127 .....	163
RD4855DT .....	95	REo851 .....	115	RNo128 .....	8
RD4856 .....	95	REo852 .....	115	RNo140 .....	198
RD4856DT .....	95	REo853 .....	115	RNo188 .....	166
RD4882 .....	95	REo854 .....	115	RNo189 .....	166
RD4882DT .....	95	REo855 .....	115	RNo211 .....	9
RD4891 .....	95	REo856 .....	115	RNo222 .....	12
RD4891DT .....	95	REo857 .....	115	RNo326 .....	15
RD4953DT .....	95	REo858 .....	115	RNo326 .....	203
RD4954DT .....	95	RNo061 .....	4	RNo330 .....	198
RD4955DT .....	95	RNo062 .....	4	RNo331 .....	198, 203
RD4956DT .....	95	RNo070 .....	4	RNo332 .....	198
RD4982DT .....	95	RNo071 .....	4	RNo401 .....	11
RD4991DT .....	95	RNo072 .....	4	RNo402 .....	11
RD5662 .....	97	RNo073 .....	4	RNo403 .....	11
RD5663 .....	97	RNo074 .....	5	RNo404 .....	11
RD5664 .....	97	RNo075 .....	2	RNo405 .....	11
RD5665 .....	97	RNo076 .....	3	RNo413 .....	12



RNo600 .....	114	RNo927 .....	114	RN2321 .....	53
RNo6001 .....	114	RNo928 .....	114	RN2322 .....	53
RNo601 .....	114	RNo929 .....	114	RN2323 .....	53
RNo602 .....	114	RNo930 .....	114	RN2401 .....	57
RNo603 .....	114	RNo948 .....	115	RN2402 .....	57
RNo604 .....	114	RNo949 .....	115	RN2403 .....	57
RNo605 .....	114	RNo950 .....	115	RN2404 .....	57
RNo606 .....	114	RNo951 .....	115	RN2405 .....	57
RNo607 .....	114	RNo952 .....	115	RN2406 .....	57
RNo608 .....	114	RNo953 .....	115	RN2407 .....	57
RNo609 .....	114	RNo954 .....	115	RN2408 .....	57
RNo710 .....	46	RNo955 .....	115	RN2409 .....	57
RNo711 .....	46	RNo956 .....	115	RN2501 .....	58
RNo711N .....	46	RNo957 .....	115	RN2502 .....	58
RNo711W .....	46	RNo958 .....	115	RN2503 .....	58
RNo712 .....	46	RNo960 .....	117	RN2504 .....	58
RNo712N .....	46	RNo961 .....	117	RN2506 .....	58
RNo712W .....	46	RNo962 .....	117	RN2528 .....	64
RNo713 .....	46	RNo981 .....	120	RN2536 .....	62
RNo713N .....	46	RNo982 .....	120	RN2540 .....	62
RNo713W .....	46	RNo983 .....	120	RN2575 .....	199
RNo714 .....	46	RNo986 .....	120	RN2576 .....	199
RNo714N .....	46	RNo987 .....	120	RN2577 .....	199
RNo714W .....	46	RNo988 .....	120	RN2578 .....	199
RNo820 .....	119	RNo991 .....	122	RN2614 .....	61
RNo821 .....	119	RNo992 .....	122	RN2673 .....	54
RNo822 .....	119	RNo993 .....	122	RN2688 .....	55
RNo881 .....	120	RNo994 .....	122	RN2689 .....	55
RNo882 .....	120	RNo995 .....	122	RN2721 .....	59
RNo883 .....	120	RNo996 .....	122	RN2722 .....	59
RNo883 .....	203	RN1121 .....	175	RN27225 .....	59
RNo886 .....	120	RN1122 .....	175	RN2723 .....	59
RNo887 .....	120	RN1123 .....	175	RN27235 .....	59
RNo888 .....	120	RN1124 .....	175	RN2724 .....	59
RNo897 .....	120	RN1125 .....	175	RN27245 .....	59
RNo898 .....	120	RN1126 .....	175	RN2726 .....	60
RNo899 .....	120	RN1127 .....	175	RN2727 .....	60
RNo900 .....	114	RN1127N .....	175	RN2728 .....	60
RNo901 .....	114	RN1128 .....	175	RN2729 .....	60
RNo902 .....	114	RN1128N .....	175	RN2800 .....	32
RNo903 .....	114	RN1129 .....	175	RN2801 .....	32
RNo904 .....	114	RN1129N .....	175	RN2802 .....	32
RNo905 .....	114	RN1171 .....	118	RN2803 .....	32
RNo906 .....	114	RN1172 .....	118	RN28110 .....	33
RNo907 .....	114	RN1173 .....	118	RN28111 .....	33
RNo908 .....	114	RN1181 .....	118	RN28112 .....	33
RNo909 .....	114	RN1182 .....	118	RN28113 .....	33
RNo910 .....	114	RN1183 .....	118	RN28114 .....	33
RNo920 .....	114	RN2102 .....	49	RN28115 .....	33
RNo921 .....	114	RN2104 .....	50	RN28116 .....	33
RNo922 .....	114	RN2105 .....	50	RN28117 .....	33
RNo923 .....	114	RN2300 .....	52	RN28118 .....	33
RNo924 .....	114	RN2301 .....	52	RN28119 .....	33
RNo925 .....	114	RN2302 .....	52	RN28120 .....	33
RNo926 .....	114	RN2320 .....	53	RN28121 .....	33



RN28122.....	33	RN3026.....	72	RN4754.....	103
RN28123.....	33	RN3030.....	75	RN4755.....	103
RN28124.....	33	RN3031.....	75	RN4756.....	103
RN28125.....	33	RN3032.....	75	RN4771.....	103
RN28126.....	33	RN3033.....	75	RN4802.....	106
RN28127.....	33	RN3034.....	75	RN4803.....	106
RN28210.....	33	RN3035.....	75	RN4804.....	106
RN28211.....	33	RN41022.....	106	RN4805.....	106
RN28212.....	33	RN41023.....	106	RN4806.....	106
RN28213.....	33	RN41024.....	106	RN4812.....	106
RN28214.....	33	RN41025.....	106	RN4813.....	106
RN28215.....	33	RN41026.....	106	RN4814.....	106
RN28216.....	33	RN41051.....	103	RN4815.....	106
RN28217.....	33	RN41052.....	103	RN4816.....	106
RN28218.....	33	RN41053.....	103	RN4819.....	109
RN28219.....	33	RN41054.....	103	RN4821M.....	108
RN28220.....	33	RN41055.....	103	RN4822.....	106
RN28221.....	33	RN41056.....	103	RN4822M.....	108
RN28222.....	33	RN41091.....	103	RN4822X.....	107
RN28223.....	33	RN41122.....	106	RN4823.....	106
RN28224.....	33	RN41123.....	106	RN4823M.....	108
RN28225.....	33	RN41124.....	106	RN4823X.....	107
RN28226.....	33	RN41125.....	106	RN4824.....	106
RN28227.....	33	RN41126.....	106	RN4824M.....	108
RN28310.....	33	RN41151.....	103	RN4824X.....	107
RN28311.....	33	RN41152.....	103	RN4825.....	106
RN28312.....	33	RN41153.....	103	RN4825M.....	108
RN28313.....	33	RN41154.....	103	RN4825X.....	107
RN28314.....	33	RN41155.....	103	RN4826.....	106
RN28315.....	33	RN41156.....	103	RN4826M.....	108
RN28316.....	33	RN41191.....	103	RN4826X.....	107
RN28317.....	33	RN4719.....	109	RN4833.....	103
RN28318.....	33	RN4720.....	109	RN4834.....	103
RN28319.....	33	RN4721M.....	108	RN4835.....	103
RN28320.....	33	RN4722.....	106	RN4836.....	103
RN28321.....	33	RN4722M.....	108	RN4843.....	103
RN28322.....	33	RN4722X.....	107	RN4844.....	103
RN28323.....	33	RN4723.....	106	RN4845.....	103
RN28324.....	33	RN4723M.....	108	RN4846.....	103
RN28325.....	33	RN4723X.....	107	RN4851.....	103
RN28326.....	33	RN4724.....	106	RN4851M.....	108
RN28327.....	33	RN4724M.....	108	RN4853.....	103
RN28410.....	33	RN4724X.....	107	RN4854.....	103
RN28411.....	33	RN4725.....	106	RN4855.....	103
RN28412.....	33	RN4725M.....	108	RN4856.....	103
RN28413.....	33	RN4725X.....	107	RN4860.....	103
RN28414.....	33	RN4726.....	106	RN4861.....	103
RN28415.....	33	RN4726M.....	108	RN4862.....	103
RN2877.....	22	RN4726X.....	107	RN4863.....	103
RN2878.....	22	RN4737.....	109	RN4864.....	103
RN2879.....	22	RN4739.....	109	RN4865.....	103
RN3022.....	72	RN4751.....	103	RN4866.....	103
RN3023.....	72	RN4751M.....	108	RN4872.....	103
RN3024.....	72	RN4752.....	103	RN4872.....	203
RN3025.....	72	RN4753.....	103	RN4872D.....	105



RN4873D.....	105	RN5553H.....	82	RN5764H.....	83
RN4874D.....	105	RN5554H.....	83	RN5764X.....	83
RN4875D.....	105	RN5563H.....	82	RN5780.....	81
RN4882.....	103	RN5564H.....	83	RN5780.....	203
RN4882.....	203	RN5603.....	85	RN5781.....	81
RN4890.....	103	RN5604.....	85	RN5782.....	81
RN4891.....	103	RN5605.....	85	RN5802.....	88
RN4891.....	203	RN5612H.....	81	RN5803.....	88
RN4892.....	103	RN5622H.....	81	RN5804.....	88
RN4892E.....	104	RN5622X.....	81	RN5805.....	88
RN4893.....	104	RN5632H.....	81	RN5806.....	88
RN4894.....	104	RN5643H.....	82	RN5808.....	88
RN4895.....	104	RN5644H.....	83	RN5812.....	88
RN4896.....	104	RN5653H.....	82	RN5813.....	88
RN4922.....	106	RN5654H.....	83	RN5814.....	88
RN4923.....	106	RN5663H.....	82	RN5816.....	88
RN4924.....	106	RN5664H.....	83	RN5822.....	88
RN4925.....	106	RN5680.....	81	RN5823.....	88
RN4926.....	106	RN5681.....	81	RN5824.....	88
RN4951.....	103	RN5682.....	81	RN5826.....	88
RN4952.....	103	RN5703.....	85	RN5903.....	85
RN4953.....	103	RN5704.....	85	RN5904.....	85
RN4954.....	103	RN5705.....	85	RN5905.....	85
RN4955.....	103	RN5712.....	81	RN5912H.....	81
RN4956.....	103	RN5712H.....	81	RN5922H.....	81
RN4991.....	103	RN5712H.....	203	RN5932H.....	81
RN5000.....	203	RN5712X.....	81	RN5943H.....	82
RN51112H.....	81	RN5722.....	81	RN5944H.....	83
RN51122H.....	81	RN5722H.....	81	RN5953H.....	82
RN51132H.....	81	RN5722H.....	203	RN5954H.....	83
RN51143H.....	82	RN5722X.....	81	RN5963H.....	82
RN51144H.....	83	RN5732.....	81	RN5964H.....	83
RN51153H.....	82	RN5732H.....	81	RN5980.....	81
RN51154H.....	83	RN5732X.....	81	RN5981.....	81
RN51163H.....	82	RN5743.....	82	RN5982.....	81
RN51164H.....	83	RN5743H.....	42	RN6021.....	7
RN51212H.....	81	RN5743H.....	82	RN6021.....	203
RN51222H.....	81	RN5743HX.....	42	RN6200.....	140
RN51232H.....	81	RN5743HX.....	82	RN6201.....	141
RN51243H.....	82	RN5743X.....	82	RN6202.....	141
RN51244H.....	83	RN5744.....	83	RN6203.....	141
RN51253H.....	82	RN5744H.....	83	RN6204.....	141
RN51254H.....	83	RN5744X.....	83	RN6205.....	141
RN51263H.....	82	RN5753.....	82	RN6206.....	141
RN51264H.....	83	RN5753H.....	82	RN6207.....	141
RN5423.....	197, 203	RN5753HX.....	82	RN6208.....	141
RN5424.....	197, 203	RN5753X.....	82	RN6209.....	141
RN5512H.....	81	RN5754.....	83	RN6210.....	141
RN5522H.....	81	RN5754H.....	83	RN6211.....	142
RN5526.....	84	RN5754X.....	83	RN6212.....	142
RN5527.....	84	RN5763.....	82	RN6213.....	142
RN5528.....	84	RN5763H.....	82	RN6214.....	142
RN5532H.....	81	RN5763HX.....	82	RN6215.....	142
RN5543H.....	82	RN5763X.....	82	RN6216.....	142
RN5544H.....	83	RN5764.....	83	RN6217.....	142

RN6218 .....	142	RN6705 .....	143	RN8060 .....	183
RN6219 .....	142	RN6706 .....	143	RN8061 .....	183
RN6220 .....	142	RN6707 .....	143	RN8065 .....	185
RN6230 .....	140	RN6708 .....	143	RN8066 .....	185
RN6240 .....	183	RN6709 .....	144	RN8121 .....	162
RN6241 .....	183	RN6710 .....	144	RN8122 .....	162
RN6253 .....	185	RN6711 .....	144	RN8123 .....	162
RN6254 .....	185	RN6712 .....	144	RN8124 .....	162
RN6255 .....	185	RN6713 .....	144	RN8125 .....	162
RN6256 .....	185	RN6714 .....	144	RN8126 .....	162
RN6271 .....	192	RN6715 .....	144	RN8127 .....	162
RN6272 .....	192	RN6716 .....	144	RN8128 .....	162
RN6273 .....	192	RN6717 .....	144	RN8136 .....	191
RN6274 .....	192	RN7021 .....	195, 203	RN8137 .....	191
RN6301 .....	201, 203	RN7022 .....	195, 203	RN8142 .....	183
RN6302 .....	201, 203	RN7023 .....	195, 203	RN8143 .....	183
RN6303 .....	201, 203	RN7061 .....	195, 203	RN8144 .....	183
RN6304 .....	201, 203	RN7127 .....	88	RN8145 .....	185
RN6305 .....	201	RN7128 .....	88	RN8146 .....	185
RN6305L .....	201	RN7129 .....	88	RN8147 .....	185
RN6306 .....	201	RN7130 .....	88	RN8148 .....	185
RN6306L .....	201	RN7131 .....	88	RN8149 .....	185
RN6307 .....	201, 203	RN7131 .....	203	RN82325 .....	135
RN6308 .....	201, 203	RN7132 .....	87	RN82325 .....	203
RN6309 .....	202	RN8001 .....	187	RN82327 .....	135
RN6310 .....	202	RN8001B .....	187	RN82327 .....	203
RN6311 .....	202	RN8002 .....	187	RN82425 .....	135
RN6312 .....	202	RN8002B .....	187	RN82425 .....	203
RN6313 .....	202	RN8003 .....	187	RN82427 .....	135
RN6314 .....	202	RN8003B .....	187	RN82427 .....	203
RN6315 .....	202	RN8004 .....	187	RN82510 .....	136
RN6316 .....	202	RN8004B .....	187	RN82512 .....	136
RN6323 .....	201, 203	RN8005 .....	187	RN825211 .....	135
RN6324 .....	201, 203	RN8005B .....	187	RN825211 .....	203
RN6601 .....	145	RN8006 .....	187	RN82525 .....	135
RN6602 .....	145	RN8006B .....	187	RN82525 .....	203
RN6603 .....	145	RN8007 .....	187	RN82527 .....	135
RN6604 .....	145	RN8007B .....	187	RN82527 .....	203
RN6605 .....	145	RN8008 .....	187	RN8253 .....	136
RN6606 .....	145	RN8008B .....	187	RN8254 .....	136
RN6607 .....	145	RN8009 .....	187	RN8255 .....	136
RN6608 .....	145	RN8009B .....	187	RN8256 .....	136
RN6609 .....	146	RN8020 .....	185	RN8257 .....	136
RN6610 .....	146	RN8021 .....	185	RN8258 .....	136
RN6611 .....	146	RN8022 .....	185	RN8259 .....	136
RN6612 .....	146	RN8023 .....	185	RN82610 .....	136
RN6613 .....	146	RN8025 .....	193	RN82612 .....	136
RN6614 .....	146	RN8026 .....	193	RN82625 .....	135
RN6615 .....	146	RN8028 .....	169	RN82625 .....	203
RN6616 .....	146	RN8029 .....	169	RN82627 .....	135
RN6617 .....	146	RN8030 .....	169	RN82627 .....	203
RN6626 .....	147	RN8031 .....	169	RN8263 .....	136
RN6701 .....	143	RN8032 .....	169	RN8264 .....	136
RN6702 .....	143	RN8033 .....	169	RN8265 .....	136
RN6703 .....	143	RN8034 .....	169	RN8266 .....	136
RN6704 .....	143	RN8036 .....	169	RN8267 .....	136

RN8268.....	136	RN8585.....	128	RN9210.....	133
RN8269.....	136	RN8586.....	128	RN9212.....	133
RN82725.....	135	RN8587.....	128	RN9303.....	133
RN82725.....	203	RN8588.....	128	RN9305.....	133
RN82727.....	135	RN8589.....	128	RN9307.....	133
RN82727.....	203	RN8612.....	131	RN9310.....	133
RN82810.....	136	RN8615.....	131	RN9312.....	133
RN82812.....	136	RN8703.....	129	RN9405.....	134
RN8283.....	136	RN8704.....	129	RN9407.....	134
RN8284.....	136	RN8705.....	129	RN9410.....	134
RN8285.....	136	RN8706.....	129	RN9505.....	134
RN8286.....	136	RN8707.....	129	RN9507.....	134
RN8287.....	136	RN8708.....	129	RN9510.....	134
RN8288.....	136	RN8709.....	129	RN9625.....	132
RN8289.....	136	RN8710.....	129	RN9627.....	132
RN8294.....	166	RN8711.....	129	RN9725.....	132
RN8295.....	166	RN8712.....	129	RN9727.....	132
RN8297.....	191	RN87210.....	129	RR2201.....	172
RN8298.....	191	RN87211.....	129	RR2202.....	172
RN8299.....	191	RN87212.....	129	RR2203.....	172
RN8503.....	129	RN8723.....	129	RR2204.....	172
RN8504.....	129	RN8724.....	129	RR2205.....	172
RN8505.....	129	RN8725.....	129	RR2206.....	172
RN8506.....	129	RN8726.....	129	RR2207.....	172
RN8507.....	129	RN8727.....	129	RR2208.....	172
RN8508.....	129	RN8728.....	129	RR2209.....	172
RN8509.....	129	RN8729.....	129	RR2301.....	172
RN8510.....	129	RN87610.....	128	RR2302.....	172
RN8511.....	129	RN87611.....	128	RR2303.....	172
RN8512.....	129	RN87612.....	128	RR2304.....	172
RN85210.....	129	RN8763.....	128	RR2305.....	172
RN85211.....	129	RN8764.....	128	RR2306.....	172
RN85212.....	129	RN8765.....	128	RR2307.....	172
RN8523.....	129	RN8766.....	128	RR2308.....	172
RN8524.....	129	RN8767.....	128	RR2309.....	172
RN8525.....	129	RN8768.....	128	RR2401.....	172
RN8526.....	129	RN8769.....	128	RR2402.....	172
RN8527.....	129	RN87810.....	128	RR2403.....	172
RN8528.....	129	RN87811.....	128	RR2404.....	172
RN8529.....	129	RN87812.....	128	RR2405.....	172
RN85610.....	128	RN8783.....	128	RR2406.....	172
RN85611.....	128	RN8784.....	128	RR2407.....	172
RN85612.....	128	RN8785.....	128	RR2408.....	172
RN8563.....	128	RN8786.....	128	RR2409.....	172
RN8564.....	128	RN8787.....	128	RR2501.....	172
RN8565.....	128	RN8788.....	128	RR2502.....	172
RN8566.....	128	RN8789.....	128	RR2503.....	172
RN8567.....	128	RN9103.....	133	RR2504.....	172
RN8568.....	128	RN9105.....	133	RR2505.....	172
RN8569.....	128	RN9107.....	133	RR2506.....	172
RN85810.....	128	RN9110.....	133	RR2507.....	172
RN85811.....	128	RN9112.....	133	RR2508.....	172
RN85812.....	128	RN9203.....	133	RR2509.....	172
RN8583.....	128	RN9205.....	133	RR2601.....	173
RN8584.....	128	RN9207.....	133	RR2602.....	173



RR2603.....	173	RR801311.....	126	RR8124.....	124
RR2604.....	173	RR8014.....	126	RR8125.....	124
RR2605.....	173	RR801411.....	126	RR8126.....	124
RR2606.....	173	RR8015.....	126	RR8127.....	124
RR2607.....	173	RR801511.....	126	RR8128.....	124
RR2608.....	173	RR8016.....	126	RR8129.....	124
RR2609.....	173	RR801611.....	126	RR8130.....	124
RR2701.....	173	RR8017.....	126	RR8131.....	124
RR2702.....	173	RR801711.....	126	RR8132.....	124
RR2703.....	173	RR8018.....	126	RR8133.....	124, 125
RR2704.....	173	RR801811.....	126	RR8200.....	125
RR2705.....	173	RR8019.....	126	RR8210.....	125
RR2706.....	173	RR801911.....	126	RR8211.....	125
RR2707.....	173	RR8020.....	126	RR8212.....	125
RR2708.....	173	RR802011.....	126	RR8213.....	125
RR2709.....	173	RR8021.....	126	RR8214.....	125
RR2710.....	173	RR802111.....	126	RR8215.....	125
RR2711.....	173	RR8022.....	126	RR8216.....	125
RR2712.....	173	RR802211.....	126	RR8217.....	125
RR2804.....	174	RR8023.....	126	RR8218.....	125
RR2805.....	174	RR802311.....	126	RR8219.....	125
RR2806.....	174	RR8024.....	126	RR8220.....	125
RR2807.....	174	RR802411.....	126	RR8221.....	125
RR2808.....	174	RR8025.....	126	RR8222.....	125
RR2809.....	174	RR802511.....	126	RR8223.....	125
RR2810.....	174	RR8026.....	126	RR8224.....	125
RR2811.....	174	RR802611.....	126	RR8225.....	125
RR2812.....	174	RR8027.....	126	RR8226.....	125
RR5712.....	77	RR802711.....	126	RR8227.....	125
RR5712X.....	81	RR8028.....	126	RR8228.....	125
RR5722.....	77	RR802811.....	126	RR8229.....	125
RR5722X.....	81	RR8029.....	126	RR8230.....	125
RR5732.....	77	RR802911.....	126	RR8231.....	125
RR5743.....	77	RR8030.....	126	RR8232.....	125
RR5744.....	77	RR803011.....	126	RR8810.....	126
RR5753.....	77	RR8031.....	126	RS0900.....	115
RR5754.....	77	RR803111.....	126	RS1120.....	175
RR5763.....	77	RR8032.....	126	RS2400.....	30
RR5764.....	77	RR803211.....	126	RS2800.....	32
RR5912.....	77	RR8033.....	126	RS5000.....	203
RR5922.....	77	RR803311.....	126	RS6219.....	142
RR5932.....	77	RR8100.....	124	RS6600.....	146
RR5943.....	77	RR8110.....	124	RS6700.....	144
RR5944.....	77	RR8111.....	124	RS8000.....	187
RR5953.....	77	RR8112.....	124	RT0145.....	169
RR5954.....	77	RR8113.....	124	RT0146.....	169
RR5963.....	77	RR8114.....	124	RU2400.....	30
RR5964.....	77	RR8115.....	124	RU2403.....	31
RR8000.....	126	RR8116.....	124	RU2404.....	31
RR8010.....	126	RR8117.....	124	RU2405.....	31
RR801011.....	126	RR8118.....	124	RU2406.....	31
RR8011.....	126	RR8119.....	124	RU2408.....	31
RR801111.....	126	RR8120.....	124	RU2409.....	31
RR8012.....	126	RR8121.....	124	RU2410.....	31
RR801211.....	126	RR8122.....	124	RU2411.....	31
RR8013.....	126	RR8123.....	124	RU2412.....	31



RU2413.....	31
RU2414 .....	31
RU2415.....	31
RU2416 .....	31
RU2417.....	31
RU2418 .....	31
RU2419 .....	31
RU2420.....	31
RU2421 .....	31
RU2422 .....	30
RU2428 .....	31
RU2429.....	31
RU2430.....	31
RU2431.....	31
RU2432 .....	31
RU2433 .....	31
RU2434 .....	31
RU2435 .....	31
RU2436 .....	31
RU2437 .....	31
RU2438 .....	31
RU2439.....	31
RU2446.....	31
RU2447 .....	31
RU2448.....	31
RU2449.....	31
RU2450.....	31
RU2451 .....	31
RU2452 .....	31
RU2453 .....	31
RU2454 .....	31
RU2455 .....	31
RU2456.....	31
RU2457 .....	31
RU2464.....	31
RU2465.....	31
RU2466.....	31
RU2467 .....	31
RU2468.....	31
RU2469.....	31

**Integra® Ruggles®-Redmond™**

Neuro/Spine Surgical Instruments

For more information or to place an order, please contact:

Integra ■ 589 Davies Drive, York, PA 17402

877-468-5572 USA ■ 914-789-7094 outside USA

800-275-7192 fax ■ 609-750-4218 outside USA fax

[integralife.com](http://integralife.com)



Ruggles, Integra and the Integra logo are registered trademarks of Integra LifeSciences Corporation or its subsidiaries in the United States and/or other countries. Redmond, Flexi-Spine, Stealth, Diamond, Redmond, LumbarTrak, Ultra-Coat, BUZZ, and BUZZ Lite are trademarks of Integra LifeSciences Corporation or its subsidiaries.

©2012 Integra LifeSciences Corporation. All rights reserved. Printed in the USA. 10K. 0054975