

INTEGRA™  
LIMIT UNCERTAINTY



Integra™ Jarit®  
Surgical Instruments



# Introduction

**Table of Contents**

Guarantee/Warranty..... III

Trademarks ..... III

Returned Goods Policy..... III

General Operating Instruments ..... 1

Orthopedic Instruments and General Surgical Instruments..... 197

Microsurgery Instruments and General Surgical Instruments..... 263

Neurosurgical and Spinal Instruments and General Surgical Instruments ..... 287

Thoracic and Cardiovascular Instruments and General Surgical Instruments ..... 345

Cardiovascular Clamps I, Abdominal and Thoracic Instruments..... 433

Cardiovascular Clamps II, Pediatric and Peripheral Vascular Instruments ..... 455

Titanium Instruments ..... 487

Ophthalmic Instruments and General Surgical Instruments ..... 507

Ear and Nose Instruments and General Surgical Instruments ..... 563

Plastic and Reconstructive Instruments and General Surgical Instruments..... 627

Post Nasal and Sinus Endoscopy Instruments and General Surgical Instruments..... 697

Post Nasal Instruments ..... 698

Sinus Endoscopy Instrumentation ..... 703

Throat and Laryngeal Instruments and General Surgical Instruments..... 713

Dental and Oral Instruments..... 731

Rectal and Genito-Urinary Instruments and General Surgical Instruments ..... 745

Obstetrical and Gynecological Instruments and General Surgical Instruments ..... 761

Bariatric Instruments and General Surgical Instruments ..... 793

Containers, Trays and Accessories..... 801

Needle Holder Suture Guide ..... 823

Conversion Tables..... 830

Numerical Index..... 835

Alphabetical Index..... 869

Surgical Instrument Product Lines ..... 901



## Guarantee/Warranty

Integra™ Jarit® Instruments are guaranteed against defects in material and workmanship. Integra will, at its option and without charge, either repair or replace any instrument which Integra determines to be defective in material or workmanship when used for its intended surgical purpose.

All Jarit instruments sold by Integra are warranted only to the original purchaser and only against defects in workmanship or materials which under the intended use render such instruments inoperable.

All Jarit® Carb-Bite™ and Jarit Carb-Edge™ instruments are further warranted for a period of three (3) years under normal use. Should any adjustment become necessary during this warranty period, Carb-Edge Scissors will be sharpened, and Carb-Bite Needle Holder jaw inserts will be replaced, without charge.

All Jarit Supercut™ Scissors are further warranted for a period of one year under normal use. Should any sharpening become necessary during this warranty period, Jarit will provide this service without charge. A nominal charge will be made for sharpening after expiration of this warranty.

This Guarantee/Warranty shall be void in the event any JARIT® instrument is used for purposes other than as originally intended, is not maintained or cleaned properly, is damaged as a result of misuse or accident, or is repaired or altered by unauthorized persons.

The above is a limited warranty, and it is the only warranty made by Integra for Jarit® Instruments. Integra makes no other warranty, express or implied, including any warranty of merchantability and fitness for a particular purpose, as well as any express or implied warranty to patients. Integra shall have no liability for consequential, exemplary or incidental damages even if it is aware of the possibility of such damages. No warranty or guarantee may be created by any act or statement nor may this warranty be modified in any way, except as a result of a writing signed by an officer of Integra. These limitations on the creation or modification of this warranty may not be waived or modified orally or by any conduct. The stated express warranty is in lieu of all liabilities or obligations of Integra arising out of, or in connection with, the delivery, use or performance of any Integra instrument. Integra neither assumes nor authorizes any representative or other person to assume for it any other liability in connection with Jarit Instruments.

## Ordering Procedure

A written purchase order on customer's form may be requested for purchase of Integra products.

## Acceptance of Order

Orders are accepted upon approval by Integra.

## Returned Goods Policy

Products must be returned in unopened packages with manufacturer's seals intact to be accepted for replacement or credit unless returned due to a complaint of product defect. Determination of a product defect will be made by Integra. Products will not be accepted for replacement if they have been in the possession of the customer for more than 90 days.

## Repairs and Maintenance

Should your instruments require repair or maintenance, contact Integra for return authorization and address. Instruments returned to Integra for repair must have a statement testifying that each instrument has been thoroughly cleaned and sterilized. Failure to supply evidence of cleaning and disinfection will result in a cleaning charge and delayed processing of your instrument repair.

## Product Information Disclosure

Integra and its subsidiaries ("Integra") and manufacturer exclude all warranties, except Integra's applicable standard warranty whether expressed or implied, including but not limited to, any implied warranties of merchantability or fitness for a particular purpose. Neither Integra nor manufacturer shall be liable for any incidental or consequential loss, damage, or expense, directly or indirectly arising from use of these products. Neither Integra nor manufacturer assume nor authorize any person to assume for them any other or additional liability or responsibility in connection with these products.

## Registered Trademarks

The following are registered trademarks of Integra LifeSciences Corporation or its subsidiaries:

Jarit®	Jarit Stardust®
Jarit Detach®	Petit-Point®

The following are trademarks of Integra LifeSciences Corporation or its subsidiaries:

Carb-Bite™	Jarit Supercut™
Carb-Edge™	P.e.e.r.™
Cardio-Grip™	Roto-Cam™
Jarit Articulator™	Roto-Lok™
Jarit Rotator™	Tip-It™

## Care and Handling/IFU

For Care and Handling information and Instructions for Use, please visit [www.integralife.com/jarit](http://www.integralife.com/jarit)



Integra York PA, Inc.  
589 Davies Dr.  
York, PA 17402 USA  
[integralife.com/jarit](http://integralife.com/jarit)



Miltex GmbH  
Muehlstrasse 6  
78604 Rietheim-Weilheim, Germany

©2011 Integra LifeSciences Corporation.  
All Rights Reserved.

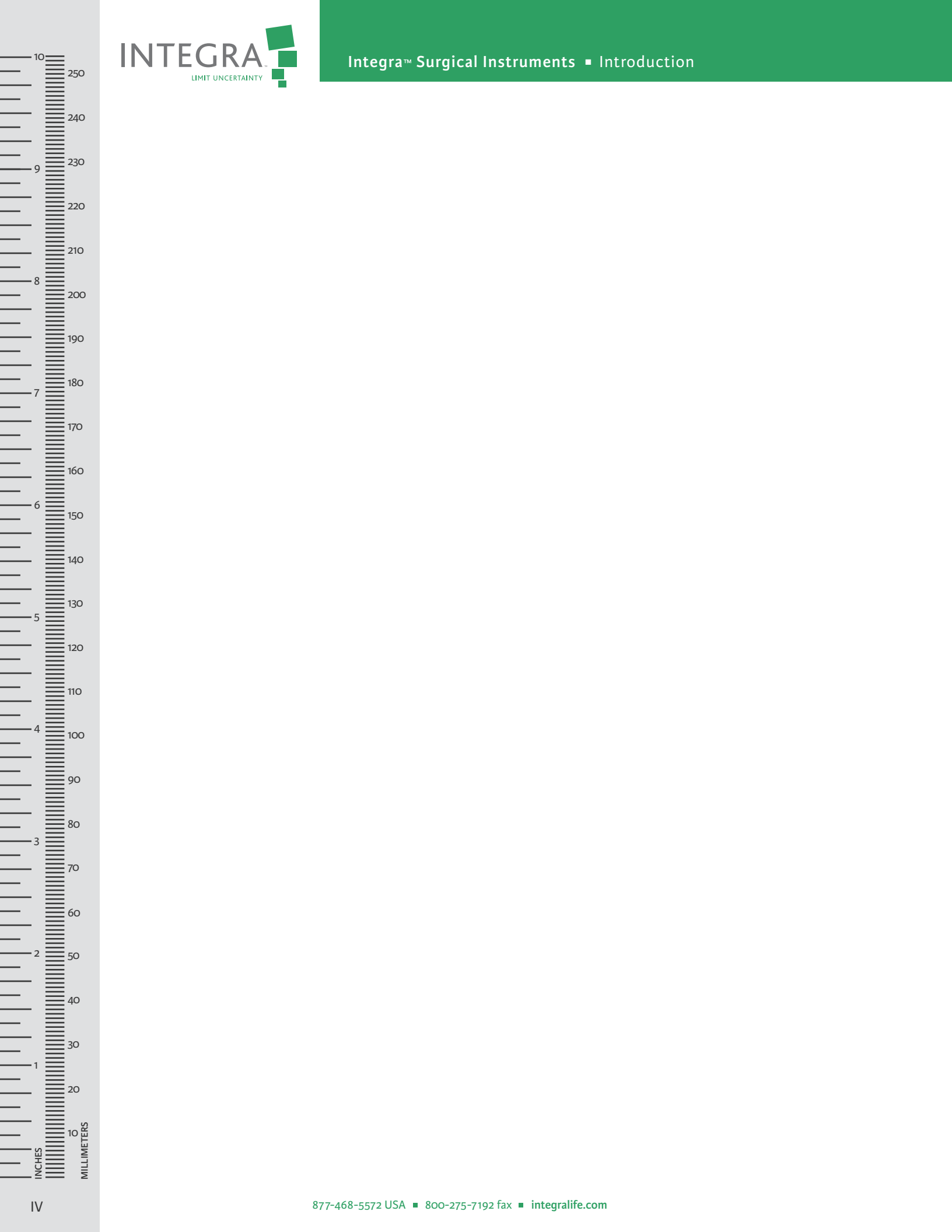



# **Integra™** General Operating Instruments

**Operating Scissors**

straight, sharp-sharp, (Mirror Finish)

Manufactured from high grade German surgical stainless steel which is ground and polished to a mirror finish

Catalog#	Description
100-105	4 <sup>3</sup> / <sub>4</sub> " (120mm)
100-109	5 <sup>1</sup> / <sub>4</sub> " (132mm)
100-110	5 <sup>7</sup> / <sub>8</sub> " (149mm)
100-111	6 <sup>1</sup> / <sub>2</sub> " (165mm)

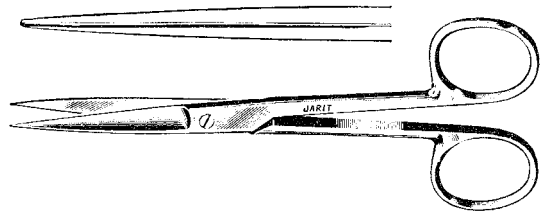

**Operating Scissors**

straight, sharp-sharp, (Matte Finish)

Manufactured from high grade German surgical stainless steel which is glass beaded to a matte finish

Catalog#	Description
099-110	5 <sup>7</sup> / <sub>8</sub> " (149mm)

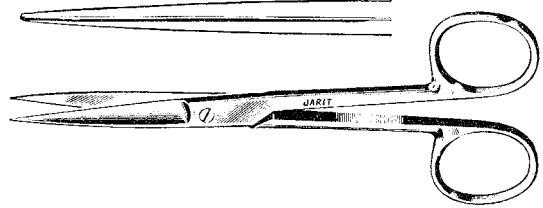

**Operating Scissors**

curved, sharp-sharp, (Mirror Finish)

Catalog#	Description
100-115	4 <sup>3</sup> / <sub>4</sub> " (120mm)
100-117	5 <sup>1</sup> / <sub>4</sub> " (132mm)
100-120	5 <sup>7</sup> / <sub>8</sub> " (149mm)
100-122	6 <sup>1</sup> / <sub>2</sub> " (165mm)

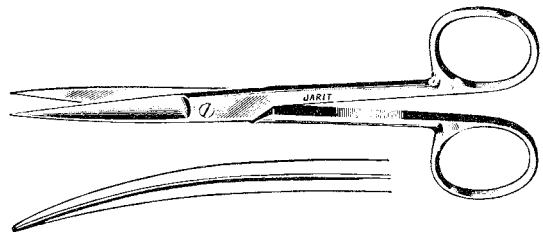



**Operating Scissors**

straight, sharp-blunt, (Mirror Finish)

Manufactured from high grade German surgical stainless steel which is ground and polished to a mirror finish

Catalog#	Description
100-125	4¾" (120mm)
100-127	5¼" (132mm)
100-130	5⅞" (149mm)
100-132	6½" (165mm)

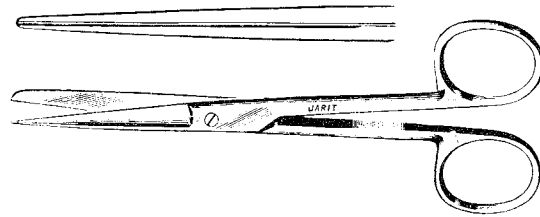

**Operating Scissors**

straight, sharp-blunt, (Matte Finish)

Manufactured from high grade German surgical stainless steel which is glass beaded to a matte finish

Catalog#	Description
099-130	5⅞" (143mm)

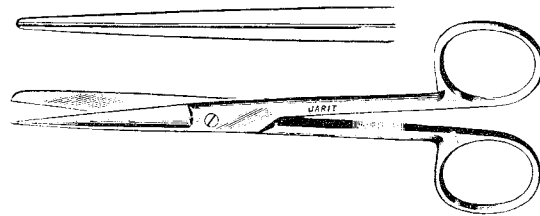

**Operating Scissors**

curved, sharp-blunt, (Mirror Finish)

Catalog#	Description
100-116	4¾" (120mm)
100-134	5¼" (132mm)
100-135	5⅞" (144mm)
100-137	6½" (165mm)

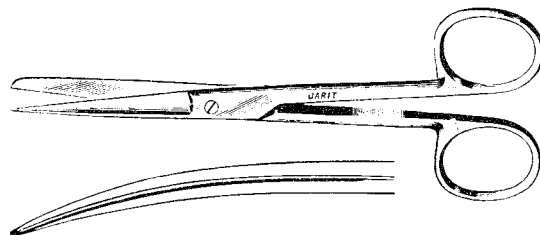

**Operating Scissors**

straight, blunt-blunt, (Mirror Finish)

Catalog#	Description
100-126	4¾" (120mm)
100-129	5¼" (132mm)
100-131	5⅞" (149mm)
100-138	6½" (165mm)

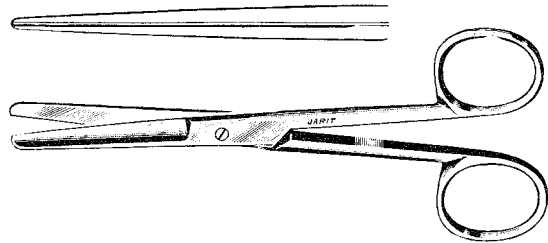

**Operating Scissors**

curved, blunt-blunt, (Mirror Finish)

Catalog#	Description
100-128	4¾" (120mm)
100-133	5¼" (132mm)
100-136	5⅞" (142mm)
100-139	6½" (165mm)

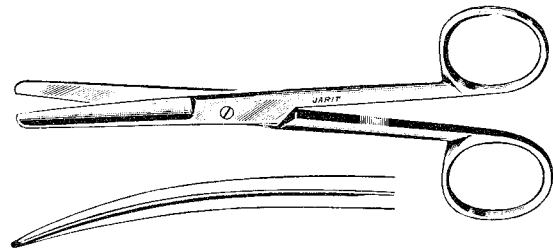

**Operating Scissors**

straight, sharp-blunt, (Mirror Finish)  
one blade serrated

Catalog#	Description
100-140	5⅞" (149mm)

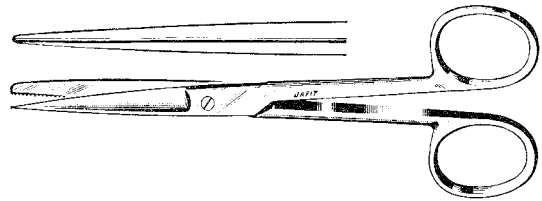

**Deaver Scissors**

sharp-sharp

Catalog#	Description
100-175	5⅞" (143mm), straight
100-180	5⅞" (143mm), curved

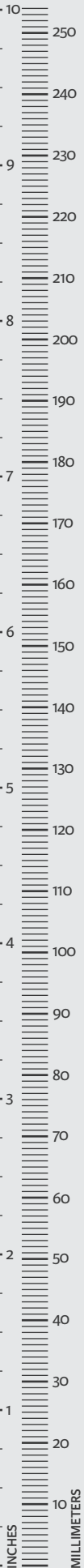
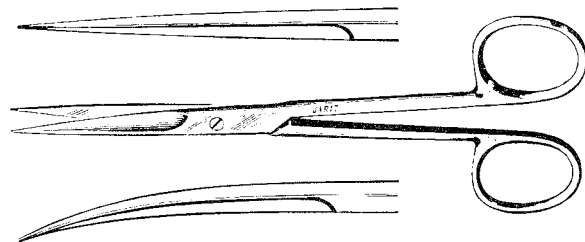

**Deaver Scissors**

sharp-blunt

Catalog #	Description
100-185	5 7/8" (143mm), straight
100-190	5 7/8" (143mm), curved

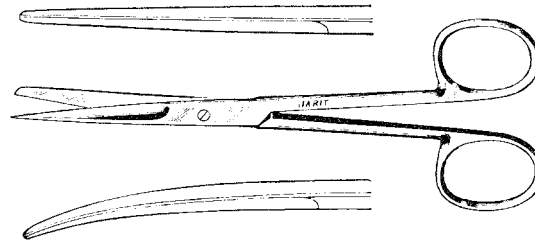

**Sistrunk Scissors**

Catalog #	Description
100-195	5 1/4" (133mm), slightly curved

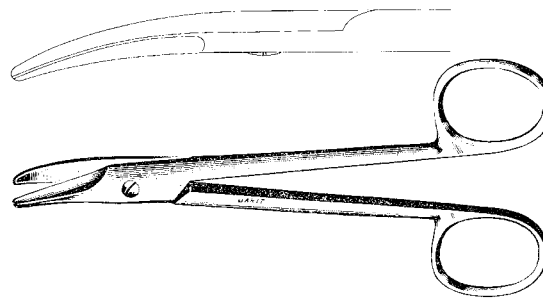

**Mayo Scissors**

beveled blades, (Mirror Finish)

Manufactured from high grade German surgical stainless steel which is ground and polished to a mirror finish

Catalog#	Description
100-200	5 3/4" (146mm), straight
100-202	5 3/4" (146mm), curved
100-210	6 3/4" (174mm), straight
100-212	6 3/4" (174mm), curved

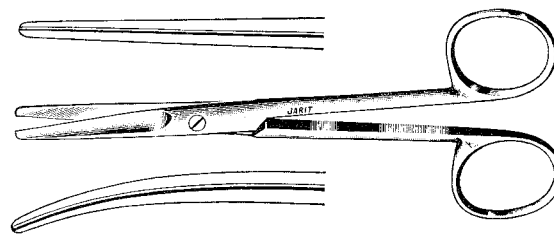

**Mayo Scissors**

beveled blades, (Matte Finish)

Manufactured from high grade German surgical stainless steel which is glass beaded to a matte finish

Catalog#	Description
099-200	5 3/4" (146mm), straight
099-202	5 3/4" (146mm), curved
099-210	6 3/4" (174mm), straight
099-212	6 3/4" (174mm), curved

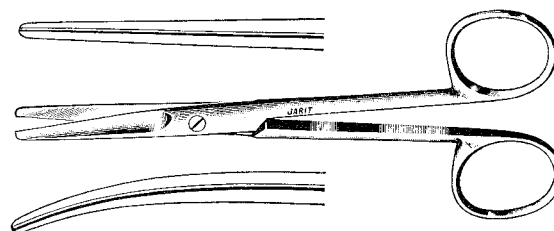

**Mayo Scissors**

round blades, (Mirror Finish)

Catalog #	Description
100-215	5 <sup>7</sup> / <sub>8</sub> " (149mm), straight
100-217	5 <sup>7</sup> / <sub>8</sub> " (149mm), curved
100-220	6 <sup>3</sup> / <sub>4</sub> " (169mm), straight
100-222	6 <sup>3</sup> / <sub>4</sub> " (169mm), curved

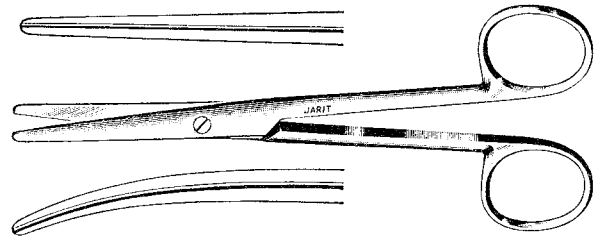

**Mayo-Noble Dissecting Scissors**

beveled blades

Catalog #	Description
100-224	6 <sup>1</sup> / <sub>2</sub> " (164mm), straight
100-225	6 <sup>1</sup> / <sub>2</sub> " (164mm), curved

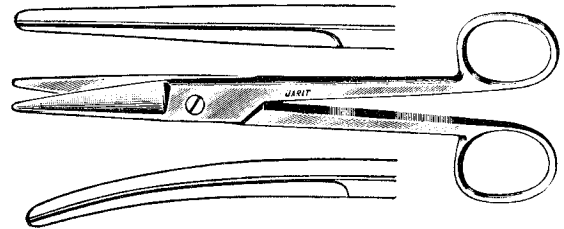

**Mayo-Noble Dissecting Scissors**

round blades

Catalog #	Description
100-226	6 <sup>1</sup> / <sub>2</sub> " (162mm), straight
100-227	6 <sup>1</sup> / <sub>2</sub> " (162mm), curved

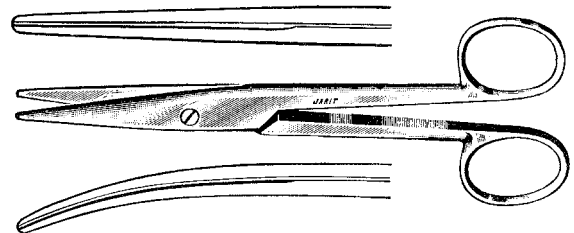

**Doyen Abdominal Scissors**

Catalog #	Description
100-230	7 <sup>1</sup> / <sub>4</sub> " (184mm), straight
100-231	7 <sup>1</sup> / <sub>4</sub> " (184mm), curved

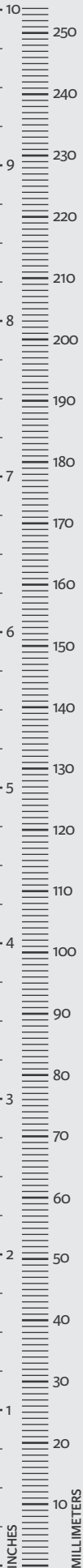
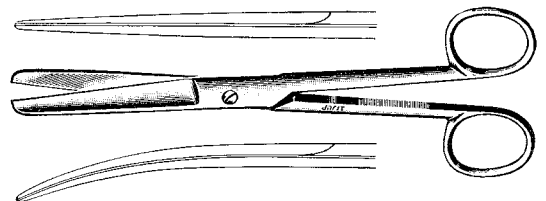

### Ferguson Abdominal Scissors

Catalog #	Description
100-233	7¼" (184mm), angled on flat

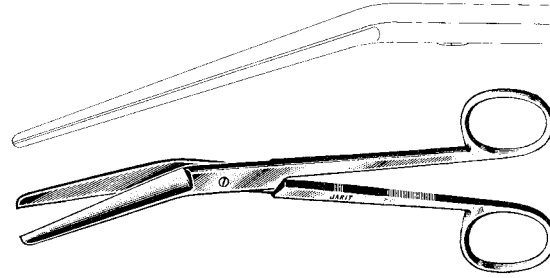

### Lillehei-Potts Scissors

Catalog #	Description
100-240	7" (180mm), straight blades, blunt tips
100-241	7" (180mm), curved blades, blunt tips
100-242	7" (180mm), straight blades, sharp tips
100-243	7" (180mm), curved blades, sharp tips
100-244	7" (180mm), straight blades, tenotomy tips
100-245	7" (180mm), curved blades, tenotomy tips

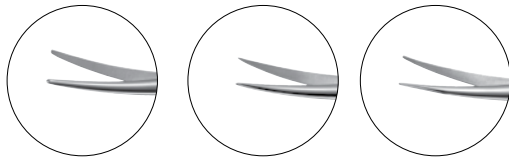

### Metzenbaum-Lahey Scissors, (Mirror Finish)

Manufactured from high grade German surgical stainless steel which is ground and polished to a mirror finish

Catalog #	Description
100-250	5⅞" (149mm), straight
100-251	5⅞" (149mm), curved

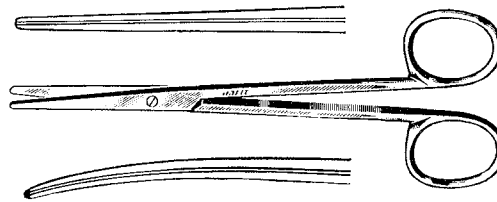

### Metzenbaum-Lahey Scissors, (Matte Finish)

Manufactured from high grade German surgical stainless steel which is glass beaded to a matte finish

Catalog #	Description
099-250	5⅞" (149mm), straight
099-251	5⅞" (149mm), curved

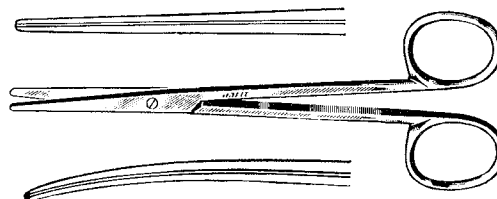

**Metzenbaum Scissors**

straight, (Mirror Finish)

Catalog #	Description
100-260	7" (180mm)
100-265	8" (206mm)

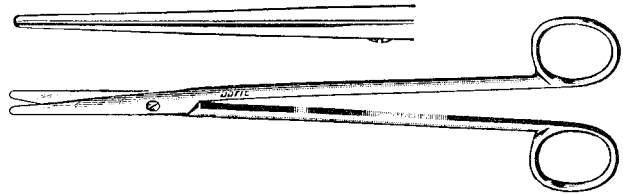

**Metzenbaum Scissors**

curved, (Mirror Finish)

Manufactured from high grade German surgical stainless steel which is ground and polished to a mirror finish

Catalog #	Description
100-261	7" (178mm), slender, delicate
100-262	7" (178mm)
100-266	8" (206mm)

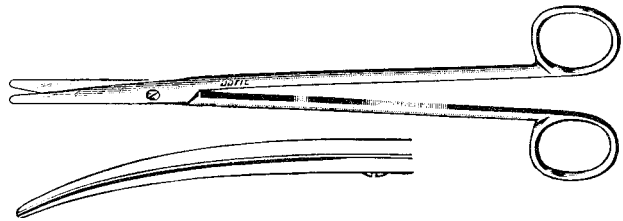

**Metzenbaum Scissors**

curved, (Matte Finish)

Manufactured from high grade German surgical stainless steel which is glass beaded to a matte finish

Catalog #	Description
099-262	7" (176mm)

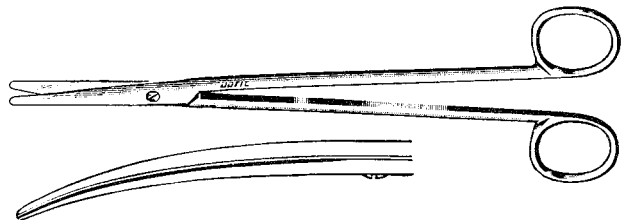

**Metzenbaum-Baby Scissors**

delicate, dissecting tips, (Mirror Finish)

Catalog #	Description
100-269	5 1/4" (135mm), straight
100-270	5 1/4" (135mm), curved

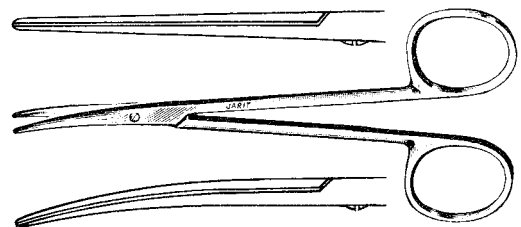

**Metzenbaum-Lahey Scissors**

curved, delicate, (Mirror Finish)

Catalog #	Description
100-272	5 <sup>5</sup> / <sub>8</sub> " (143mm)

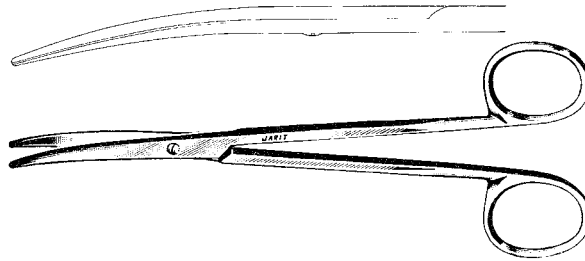

**Joseph Scissors**

Catalog #	Description
100-278	5 <sup>5</sup> / <sub>8</sub> " (143mm), straight
100-279	5 <sup>5</sup> / <sub>8</sub> " (143mm), curved

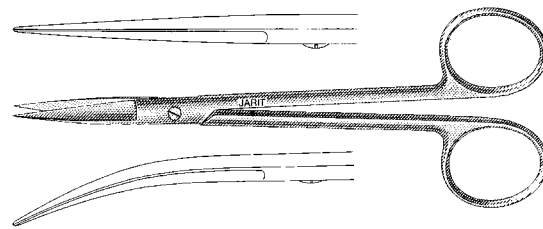

**Kelly Fistula Scissors**

Catalog #	Description
100-280	6 <sup>1</sup> / <sub>4</sub> " (158mm), straight
100-281	6 <sup>1</sup> / <sub>4</sub> " (158mm), curved

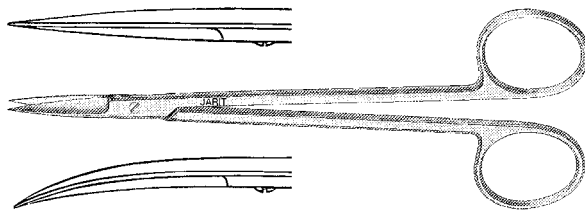

**Flat Tip Scissors**

curved

Catalog #	Description
100-290	5 <sup>3</sup> / <sub>8</sub> " (137mm)
100-291	7" (178mm)
100-292	9 <sup>1</sup> / <sub>4</sub> " (232mm)

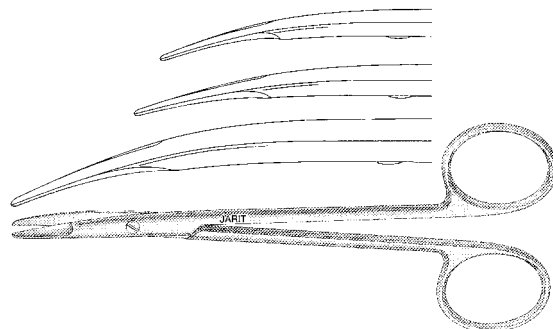

**Reynolds Scissors**

narrow tip, curved

Catalog #	Description
100-295	5 <sup>5</sup> / <sub>8</sub> " (143mm), plain edge
100-296	5 <sup>5</sup> / <sub>8</sub> " (143mm), serrated edge
100-297	7" (178mm), plain edge
100-298	7" (178mm), serrated edge

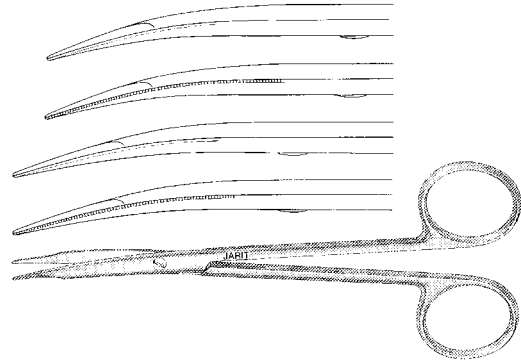

**Jamison-Metzenbaum Scissors**

narrow tip, curved

Catalog #	Description
100-300	6" (155mm)
100-302	7" (180mm)
100-304	8" (205mm)
100-306	9" (230mm)

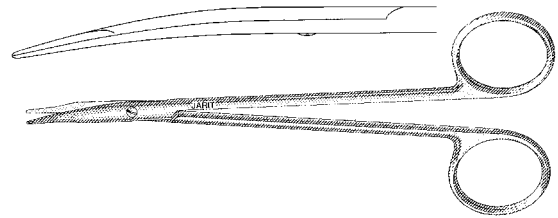

**Plastic Surgery Scissors**

sharp-blunt

Catalog #	Description
100-320	4 <sup>7</sup> / <sub>8</sub> " (124mm), straight
100-322	4 <sup>7</sup> / <sub>8</sub> " (124mm), curved

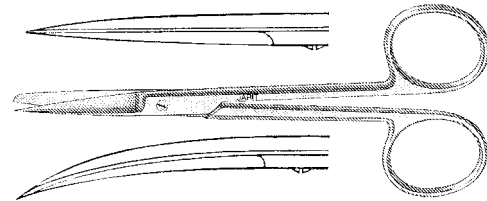

**Plastic Surgery Scissors**

sharp-sharp

Catalog #	Description
100-325	4 <sup>7</sup> / <sub>8</sub> " (124mm), straight
100-327	4 <sup>7</sup> / <sub>8</sub> " (124mm), curved

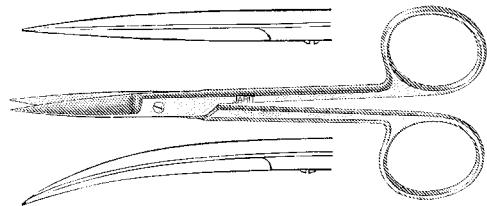

**Plastic Surgery Scissors**

blunt-blunt

Catalog #	Description
100-330	4 <sup>7</sup> / <sub>8</sub> " (124mm), straight
100-332	4 <sup>7</sup> / <sub>8</sub> " (124mm), curved

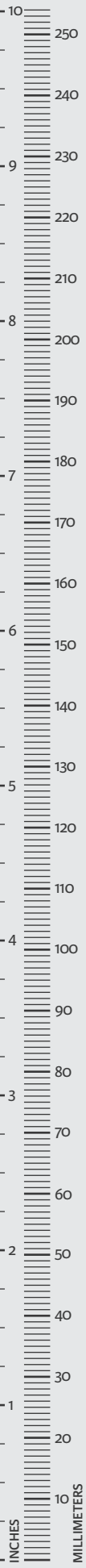
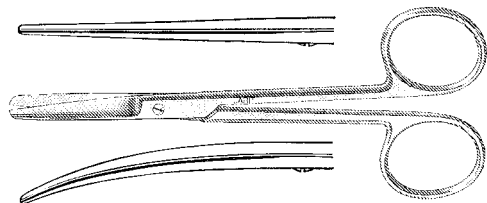



**Lister Bandage Scissors, (Mirror Finish)**

Manufactured from high grade German surgical stainless steel which is ground and polished to a mirror finish

Catalog #	Description
100-502	3 <sup>3</sup> / <sub>8</sub> " (86mm)
100-512	4 <sup>3</sup> / <sub>4</sub> " (120mm)
100-522	5 <sup>3</sup> / <sub>4</sub> " (145mm)
100-526	7 <sup>1</sup> / <sub>4</sub> " (184mm)
100-528	8" (206mm)

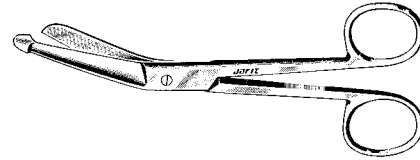

**Lister Bandage Scissors, (Matte Finish)**

Manufactured from high grade German surgical stainless steel which is glass beaded to a matte finish

Catalog #	Description
099-522	5 <sup>3</sup> / <sub>4</sub> " (145mm)
099-526	7 <sup>1</sup> / <sub>4</sub> " (184mm)
099-528	8" (206mm)

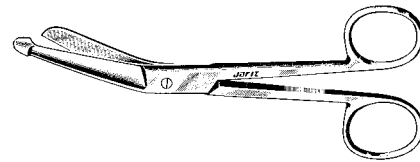

**Lister Bandage Scissors**

one large ring, (Mirror Finish)

Catalog #	Description
100-527	8" (203mm)



**Knowles Finger Bandage Scissors**

Catalog #	Description
100-530	5 <sup>3</sup> / <sub>4</sub> " (145mm)

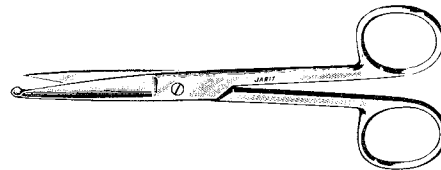

**Knowles Finger Bandage Scissors**

Catalog #	Description
100-531	5 <sup>1</sup> / <sub>2</sub> " (140mm), side curved
100-532	5 <sup>1</sup> / <sub>2</sub> " (140mm), one blade serrated

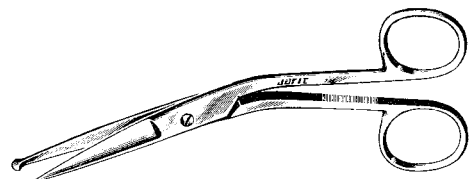

**Universal Bandage Scissors**

one serrated blade, stainless steel with autoclavable plastic finger rings

Catalog #	Description
100-539	5¾" (145mm), black

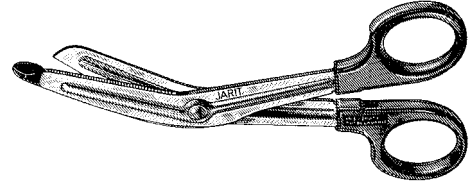

**Universal Bandage Scissors**

one serrated blade, stainless steel with autoclavable plastic finger rings

Catalog #	Description
100-540	7½" (190mm), black
100-541	7½" (190mm), red
100-542	7½" (190mm), orange
100-543	7½" (190mm), blue
100-544	7½" (190mm), purple
100-545	7½" (190mm), green
100-546	7½" (190mm), yellow



**New's Suture Scissors**

Catalog #	Description
125-165	5⅝" (142mm), angled on flat

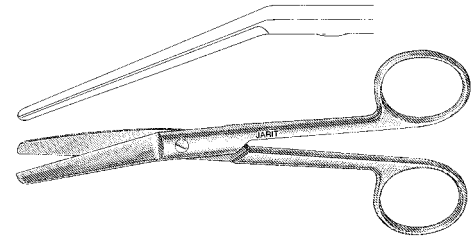

**Universal Wire Suture Scissors**

Catalog #	Description
125-170	4¾" (122mm), angled, one serrated blade

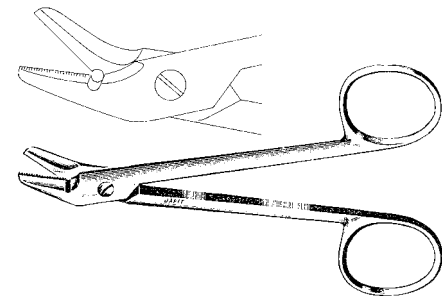

**Universal Wire Suture Scissors, Carb-Edge**  
for cutting suture and wire (26 gauge and smaller)

Catalog #	Description
101-350	4⅞" (124mm), angled, for cutting suture and wire (26 gauge and smaller)

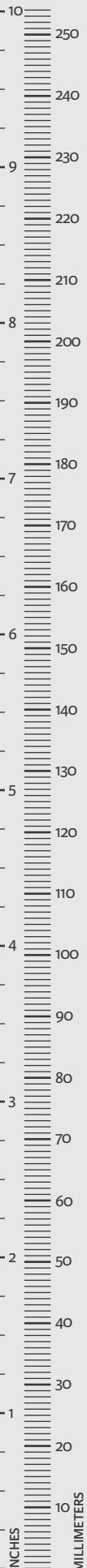
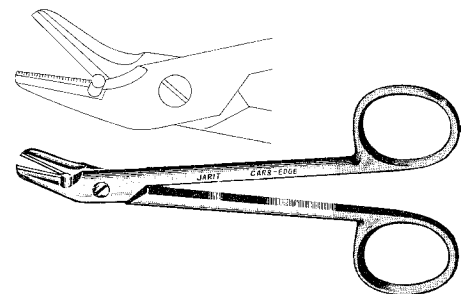

### Heath Suture Scissors

Catalog #	Description
125-175	6" (155mm), serrated

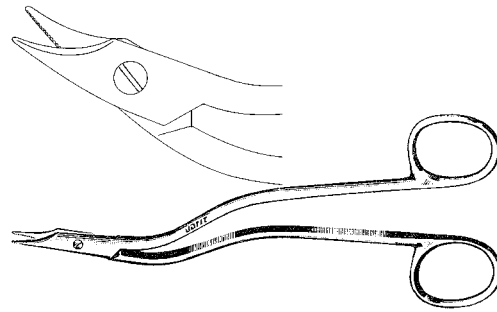

### Spencer Suture Scissors

Catalog #	Description
125-180	3½" (90mm)
125-182	5" (127mm)

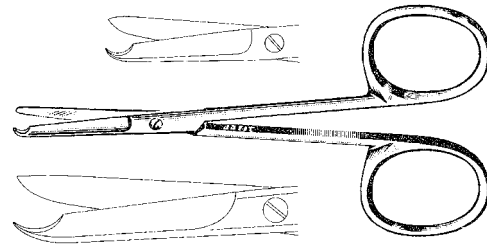

### Spencer Suture Scissors curved sideways

Catalog #	Description
125-184	3½" (90mm)
125-185	4¾" (121mm)

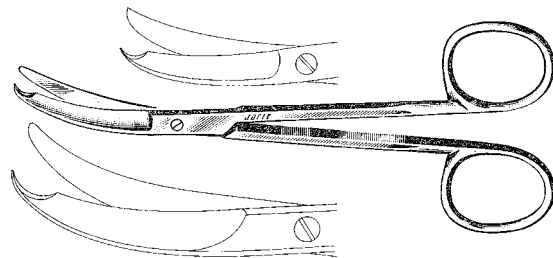

### Littauer Stitch Scissors

Catalog #	Description
125-190	5½" (140mm)

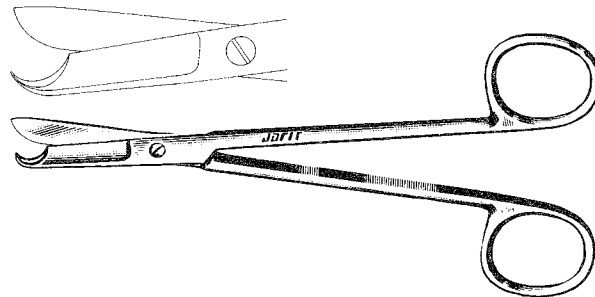

**Suture Wire Scissors**

serrated

Catalog #	Description
125-192	4 1/8" (104mm), straight
125-193	4 1/8" (104mm), curved

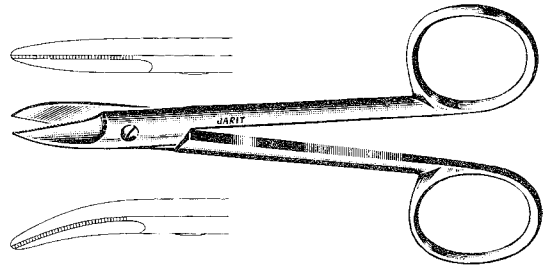

**Smith Wire Scissors**

Catalog #	Description
125-194	6 3/8" (171mm)

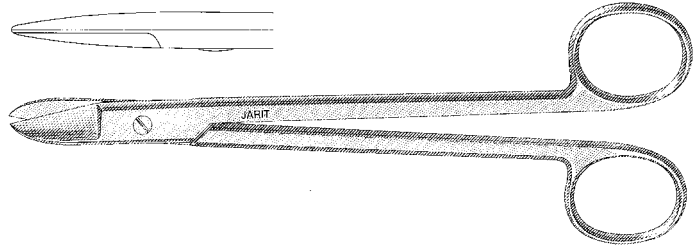

**O'Brien Suture Scissors**

Catalog #	Description
125-195	3 7/8" (100mm), angled

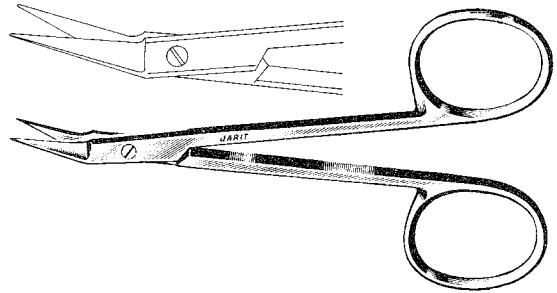

**Thorek Gall Bladder Scissors**

Catalog #	Description
140-320	7 1/4" (185mm), full curve
140-322	9" (230mm), full curve

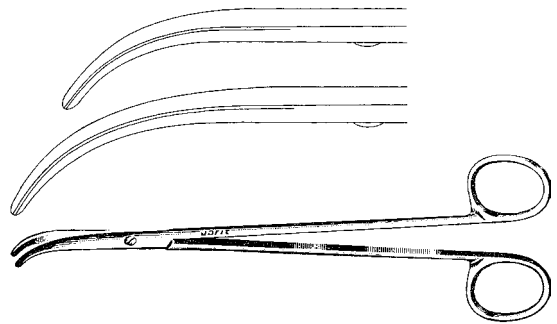

**Martin Cartilage Scissors**

Catalog #	Description
270-150	7 3/4" (200mm), curved, 50mm serrated blade

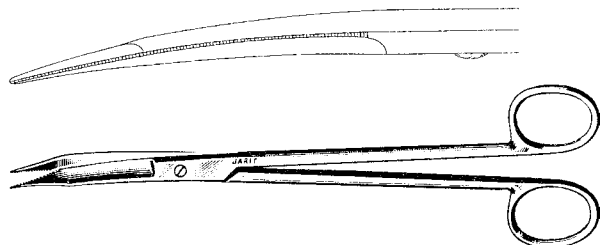

### Frazier (Schmeden) Dura Scissors

Catalog #	Description
295-200	6½" (165mm)

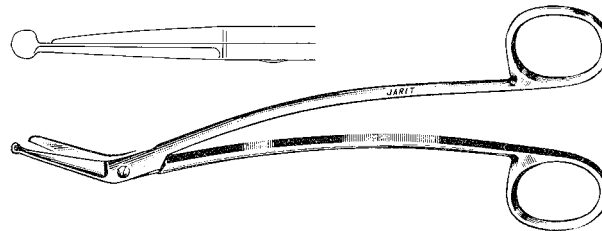

### Taylor Dura Scissors

delicate

Catalog #	Description
295-205	5½" (140mm)

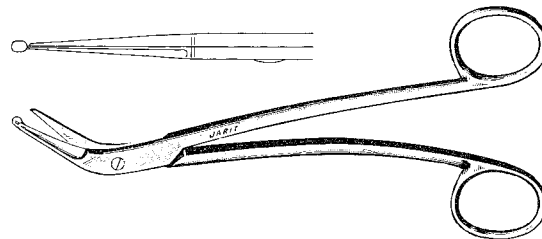

### Dandy Trigeminal Scissors

Catalog #	Description
295-210	6¾" (172mm)
295-211	7¾" (197mm)

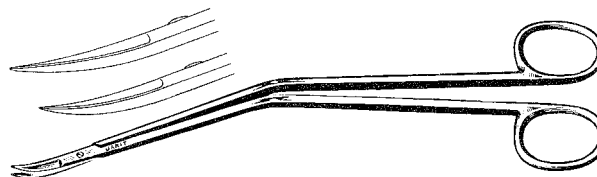

### Strully Scissors

Catalog #	Description
295-215	7¾" (200mm)

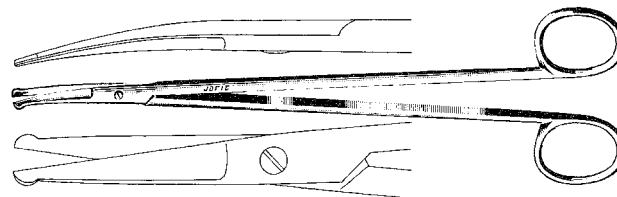

### Adson Ganglion Scissors

6¼" (158mm)

Catalog #	Description
295-220	Straight
295-221	Curved

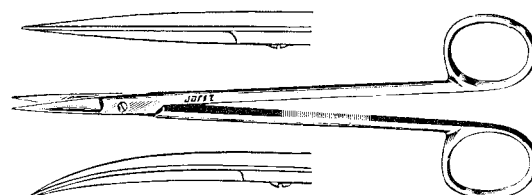

**Metzenbaum-Nelson Scissors**

Catalog #	Description
305-100	9¼" (235mm), straight
305-101	9¼" (235mm), curved
305-105	11¼" (286mm), straight
305-106	11¼" (286mm), curved
305-110	14½" (367mm), curved

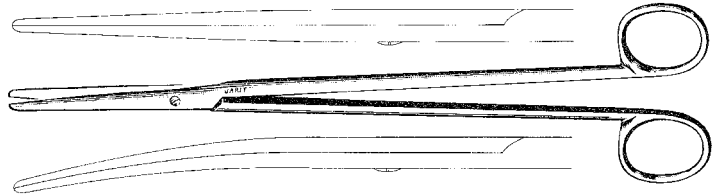

**Jorgenson Scissors**

Catalog #	Description
305-120	8¾" (222mm), curved

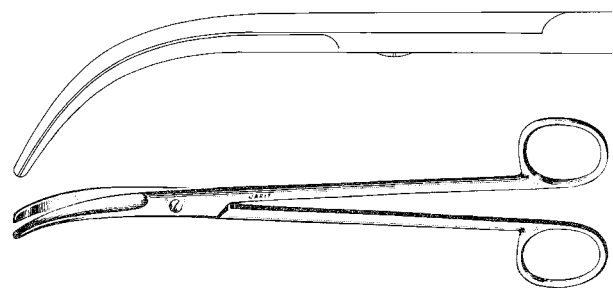

**Cooley Scissors**

Catalog #	Description
305-125	7½" (191mm), curved

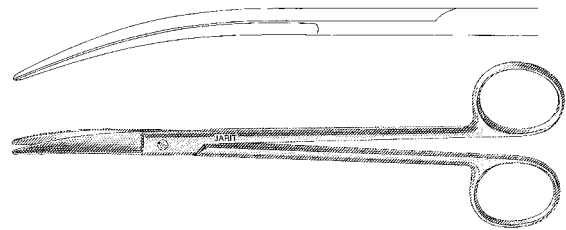

**Willauer Scissors**

Catalog #	Description
305-130	10¼" (260mm), straight
305-131	10¼" (260mm), curved
305-135	12" (305mm), straight
305-136	12" (303mm), curved

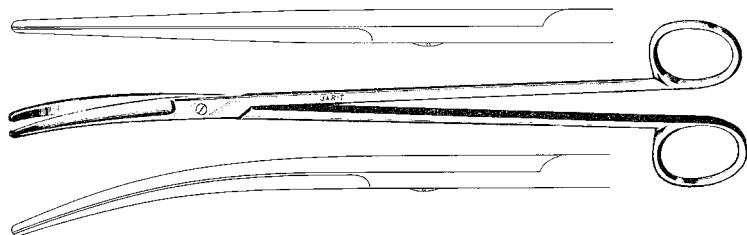

**Mayo-Harrington Scissors**

Catalog #	Description
305-140	9" (230mm), straight
305-141	9" (230mm), curved
305-145	11" (280mm), straight
305-146	11" (280mm), curved

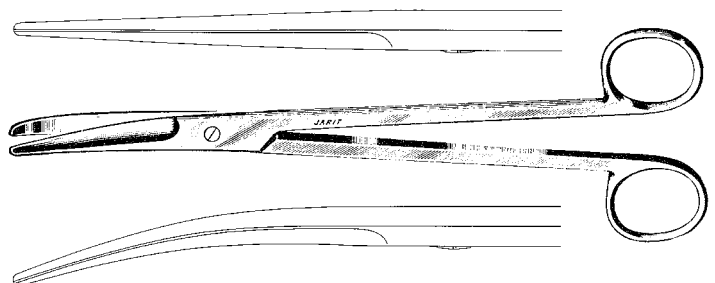

**Potts-Smith Dissecting Scissors, Curved**

Catalog #	Description
310-290	5¾" (145mm)
310-291	7¼" (184mm)
310-292	9¼" (232mm)

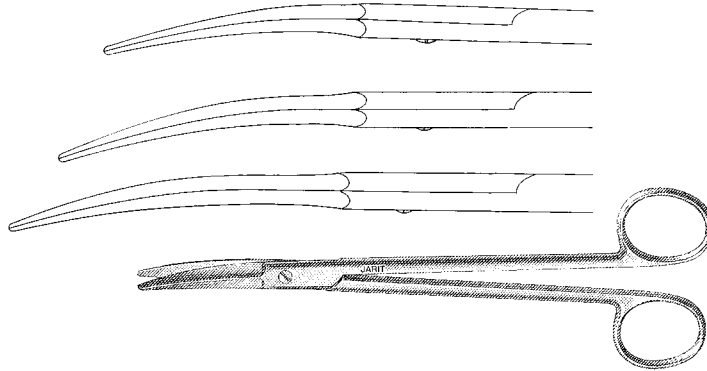

**Satinsky Vascular Scissors**

Catalog #	Description
310-300	9½" (243mm), curved shanks, acutely curved tips

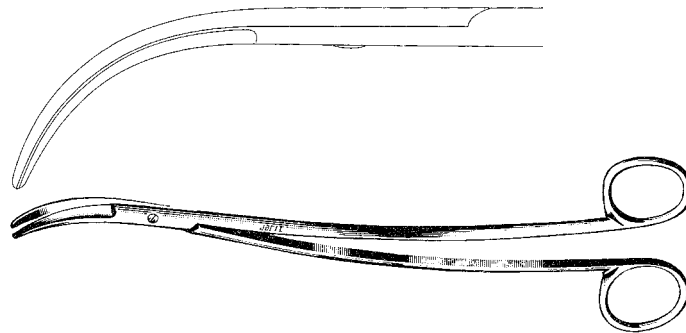

**DeMartel Vascular Scissors, Curved**

Catalog #	Description
310-302	6¾" (174mm), blunt tips
310-303	6¾" (174mm), sharp tips

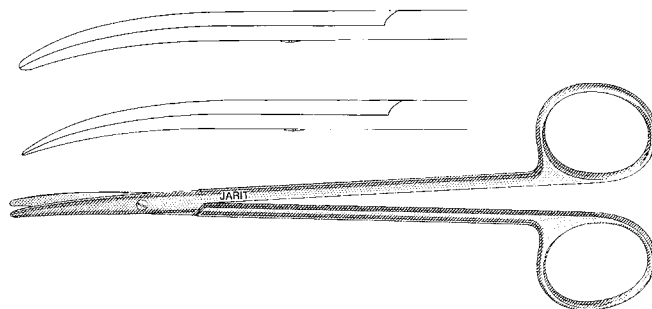

**Endarterectomy Vascular Scissors**

Catalog #	Description
310-330	6¾" (172mm), curved

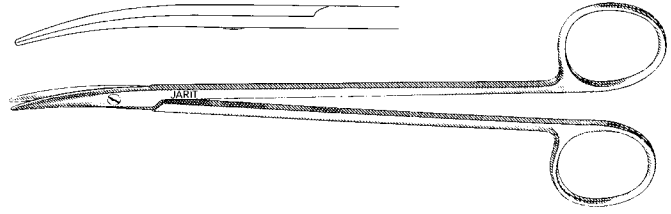

**DeBakey Endarterectomy Scissors**

Catalog #	Description
310-349	7" (178mm), full curve

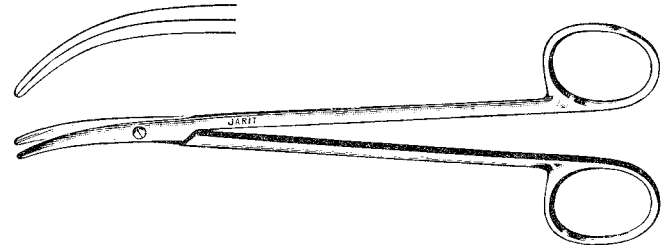

**Lincoln Vascular Scissors**

Catalog #	Description
310-367	10" (255mm), straight
310-368	10" (254mm), curved
310-369	6¾" (174mm), straight
310-370	6¾" (173mm), curved

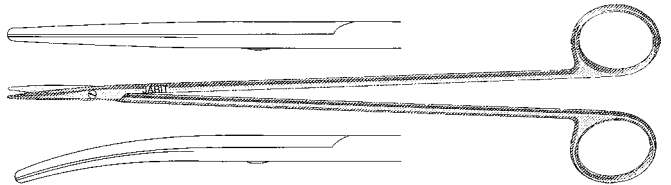

**Church Vascular Scissors**

Catalog #	Description
310-375	7" (175mm), straight
310-376	7" (175mm), curved

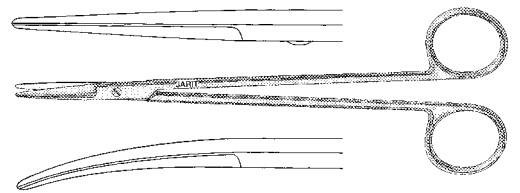

**Mattox-Potts Scissors**

Catalog #	Description
310-304	5⅜" (137mm), 45° angle, 22mm blades

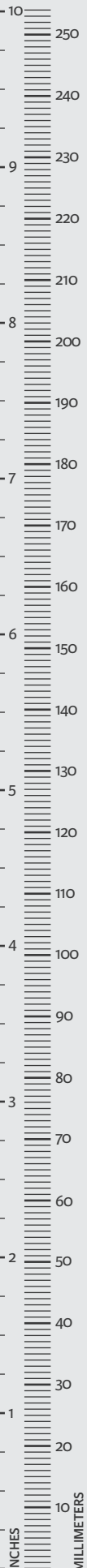
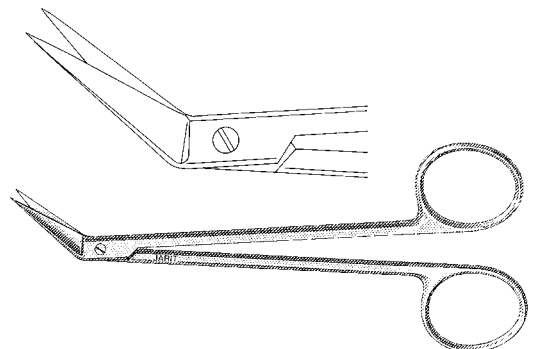



**Potts-Smith Vascular Scissors**

Catalog #	Description
310-310	7½" (189mm), 25° angle, 22mm blades
310-315	7¼" (185mm), 45° angle, 22mm blades
310-320	7" (180mm), 60° angle, 19mm blades

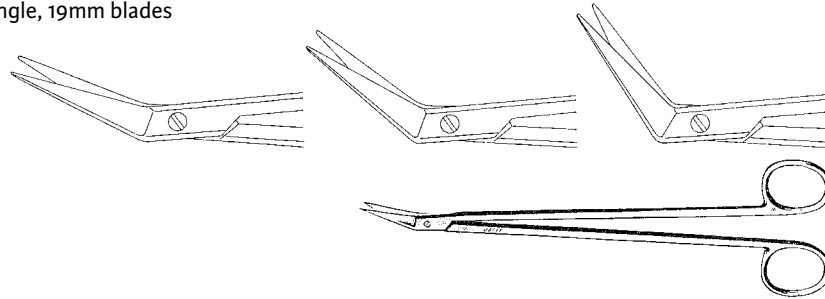

**DeBakey-Potts Vascular Scissors**

23mm blades

Catalog #	Description
310-332	6½" (168mm), 25° angle
310-333	6½" (163mm), 45° angle
310-334	6¼" (158mm), 60° angle

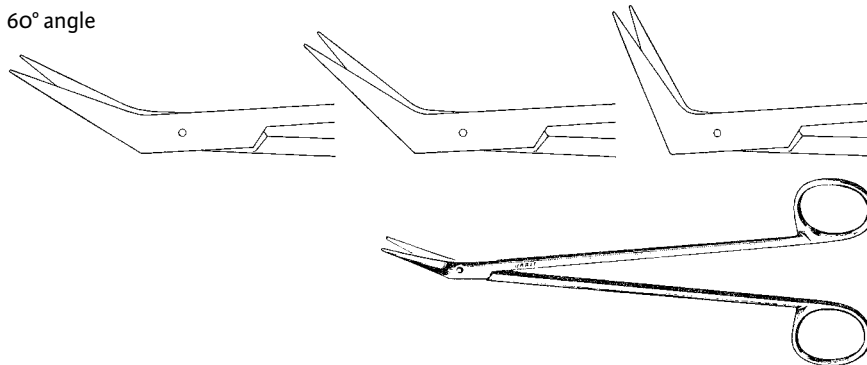

**DeBakey Vascular Scissors**

23mm blades

Catalog #	Description
310-340	6½" (168mm), 25° angle
310-341	6½" (163mm), 45° angle
310-342	6¼" (158mm), 60° angle
310-343	9" (230mm), 25° angle
310-344	9" (227mm), 45° angle
310-345	8¾" (221mm), 60° angle

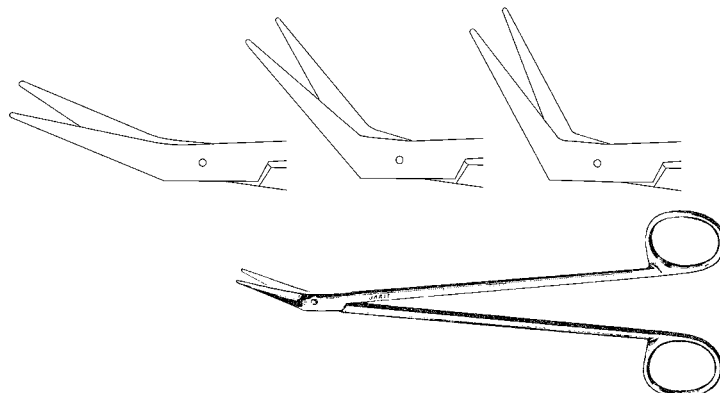

**Diethrich Coronary Artery Scissors**

Catalog #	Description
310-350	7" (182mm), 12mm blades, 25° angle
310-351	7" (180mm), 13mm blades, 45° angle
310-352	7" (177mm), 13mm blades, 60° angle
310-353	7" (172mm), 13.5mm blades, 90° angle
310-354	7" (172mm), 12.5mm blades, 120° angle

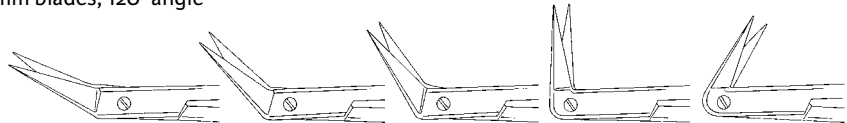

**Diethrich Coronary Artery Scissors**

extra delicate blade

Catalog #	Description
311-350	7" (182mm), 14mm blades, 25° angle
311-351	7" (179mm), 14mm blades, 45° angle
311-352	7" (176mm), 14mm blades, 60° angle
311-353	7" (176mm), 14mm blades, 90° angle
311-354	7" (176mm), 14mm blades, 120° angle

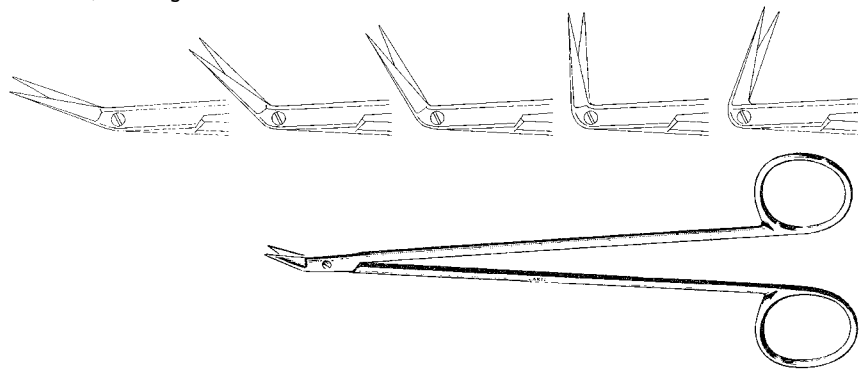

**Diethrich Circumflex Artery Scissors**

with stabilizing bar

Catalog #	Description
310-360	6¾" (172mm), 130° angle, 13mm blades

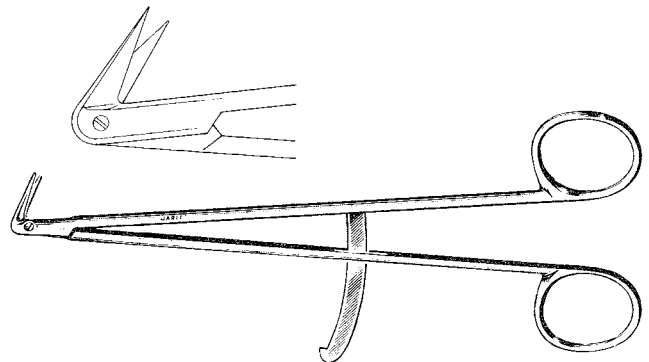

**Diethrich-Potts Peripheral Vascular Scissors**

Catalog #	Description
310-355	5 <sup>3</sup> / <sub>8</sub> " (138mm), 25° angle, 12mm blades
310-356	5 <sup>3</sup> / <sub>8</sub> " (135mm), 45° angle, 13mm blades
310-357	5 <sup>1</sup> / <sub>4</sub> " (133mm), 60° angle, 13mm blades
310-358	5" (126mm), 90° angle, 13.5mm blades

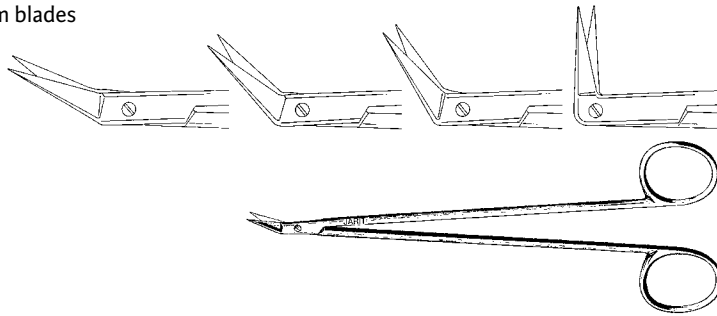

**Favaloro Coronary Artery Scissors**

Catalog #	Description
310-374	6 <sup>3</sup> / <sub>4</sub> " (170mm), 130° angle, 9.5mm blades

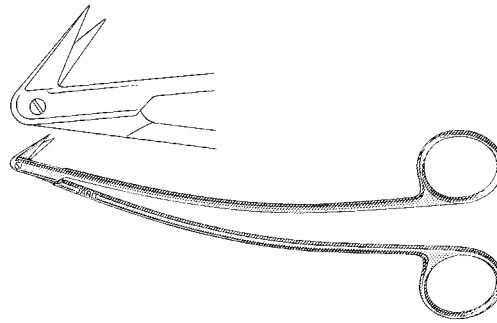

**Karmody In-Situ Valve Scissors**

Catalog #	Description
310-535	6" (152mm), working shaft, serrated blades, blunt tips

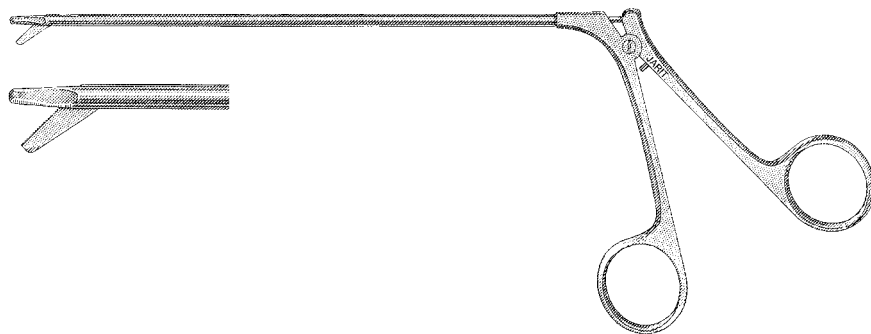

**Knapp Iris Scissors, Sharp-Sharp**

4" (103mm), 25mm blades

Catalog #	Description
360-090	Straight
360-093	Curved

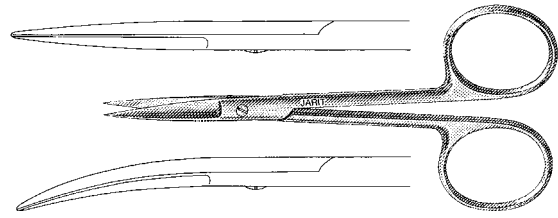

**Knapp Iris Scissors, Sharp-Blunt**

4" (103mm), 25mm blades

Catalog #	Description
360-091	Straight
360-094	Curved

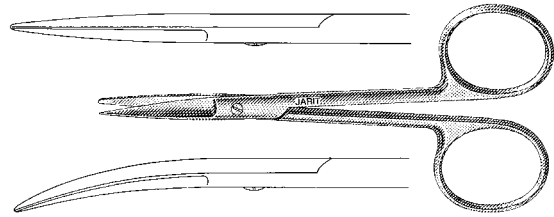

**Knapp Iris Scissors, Blunt-Blunt**

4" (103mm), 25mm blades

Catalog #	Description
360-092	Straight
360-095	Curved

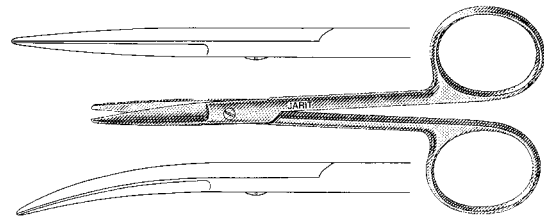

**Iris Scissors, Sharp-Sharp, (Mirror Finish)**

4<sup>5</sup>/<sub>8</sub>" (116mm), 25mm blades

Manufactured from high grade German surgical stainless steel which is ground and polished to a mirror finish

Catalog #	Description
360-100	4 <sup>5</sup> / <sub>8</sub> " (116mm), 25mm blades, straight
360-101	4 <sup>5</sup> / <sub>8</sub> " (116mm), 25mm blades, curved

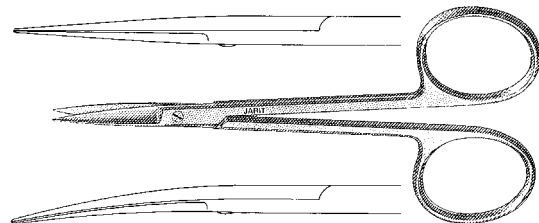

**Iris Scissors, Sharp-Sharp, (Matte Finish)**

4<sup>5</sup>/<sub>8</sub>" (116mm), 25mm blades

Manufactured from high grade German surgical stainless steel which is glass beaded to a matte finish

Catalog #	Description
359-100	4 <sup>5</sup> / <sub>8</sub> " (116mm), 25mm blades, straight
359-101	4 <sup>5</sup> / <sub>8</sub> " (116mm), 25mm blades, curved

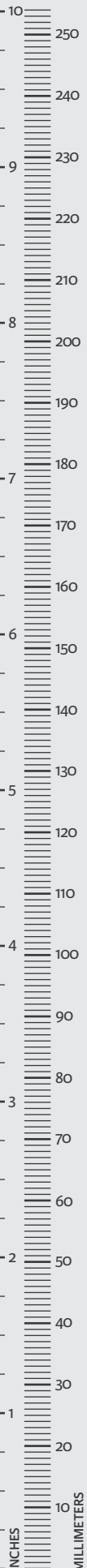
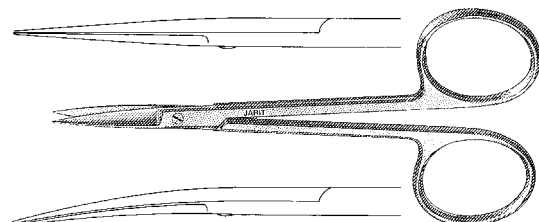

**Iris Scissors, Angled on the Side**

(Mirror Finish)

Catalog #	Description
360-102	4½" (115mm), 27mm blades

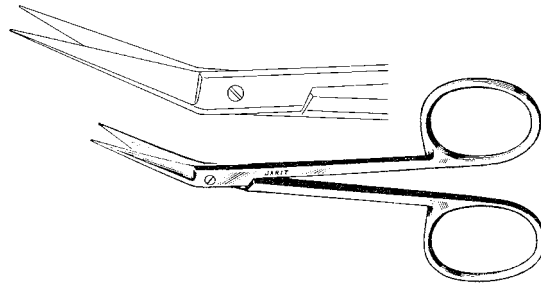

**Iris Scissors, Angled on the Side, Probe Point**

(Mirror Finish)

Catalog #	Description
360-103	4½" (115mm), 27mm blades

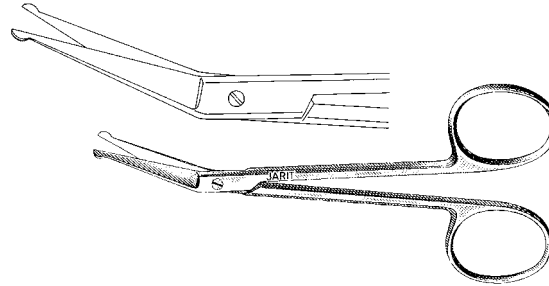

**Iris Scissors, Sharp-Sharp**

(Mirror Finish)

Catalog #	Description
360-104	3¾" (94mm), straight, 22mm blades
360-105	3¾" (94mm), curved, 22mm blades
360-110	4⅛" (105mm), straight, extra delicate, 22mm blades
360-111	4⅛" (105mm), curved, extra delicate, 22mm blades

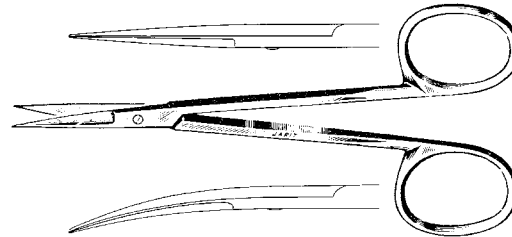

**Wilmer Conjunctival Scissors, Angled on the Flat**

Catalog #	Description
360-115	4⅛" (104mm), delicate, 15mm blades

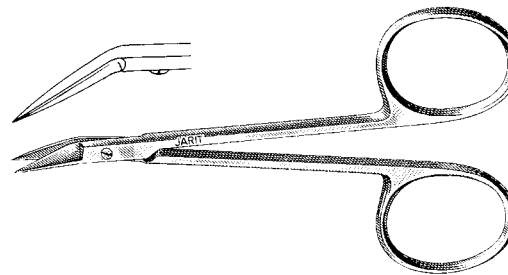

**Iris Scissors, Large Finger Rings**

3⅞" (98mm), 22mm blades, (Satin Finish)

Catalog #	Description
360-117	Straight
360-118	Curved

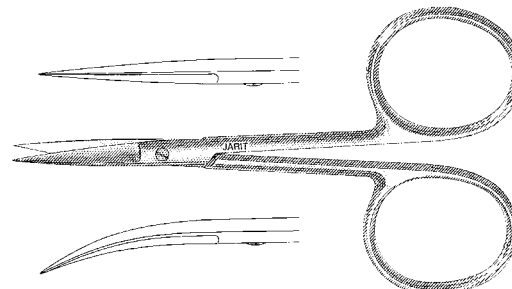

**Iris Scissors, Sharp-Sharp**

4" (103mm), delicate 26mm blades, (Mirror Finish)

Catalog #	Description
360-120	Straight
360-121	Curved

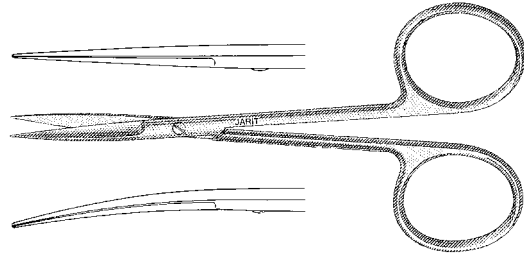

**Iris Scissors, Flat Shanks, Sharp-Sharp**

4 1/8" (104mm), 22mm blades, (Mirror Finish)

Catalog #	Description
360-122	Straight
360-123	Curved

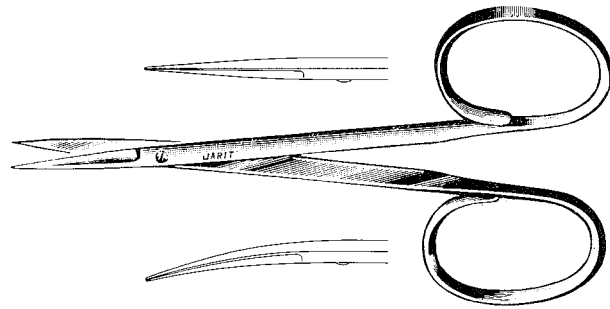

**Iris Scissors, Flat Shanks, Sharp-Sharp**

3 3/4" (96mm), delicate 13.5mm blades, (Mirror Finish)

Catalog #	Description
360-125	Straight
360-126	Curved

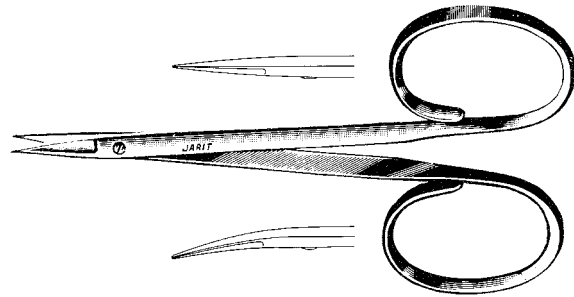

**Eye Utility Scissors, Flat Shanks, Blunt-Blunt**

3 7/8" (97mm), 16mm blades

Catalog #	Description
360-127	Straight
360-128	Curved

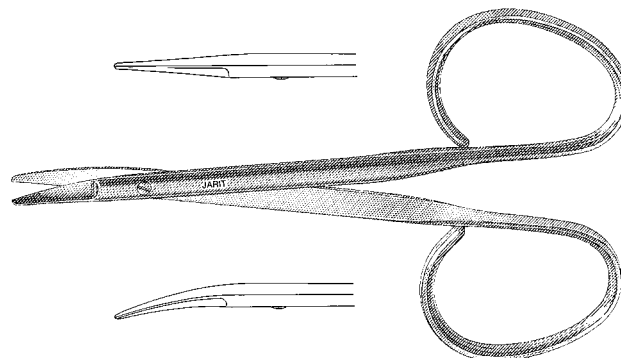

**Strabismus Scissors**

4½" (115mm), 30mm blades

Catalog #	Description
360-130	Straight
360-131	Curved

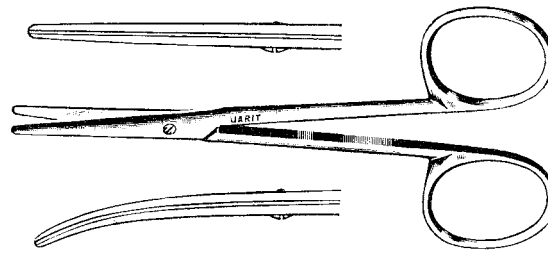

**Strabismus Scissors, Flat Shanks**

4⅞" (106mm), 25mm blades

Catalog #	Description
360-134	Straight
360-135	Curved

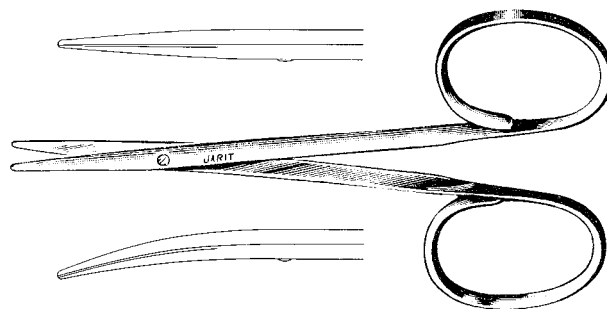

**Stevens Tenotomy Scissors, Blunt-Blunt**

4½" (115mm), slender pattern, 13mm blades

Catalog #	Description
360-138	Straight
360-139	Curved

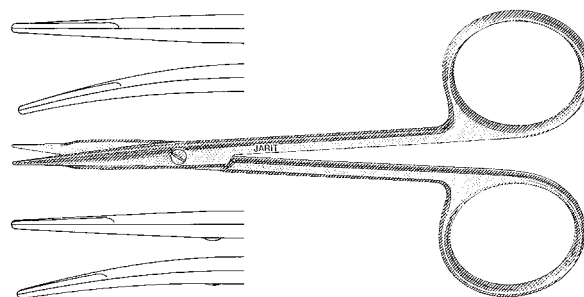

**Stevens Tenotomy Scissors, Blunt-Blunt**

4⅞" (105mm), standard pattern, 12mm blades

Catalog #	Description
360-140	Straight
360-141	Curved

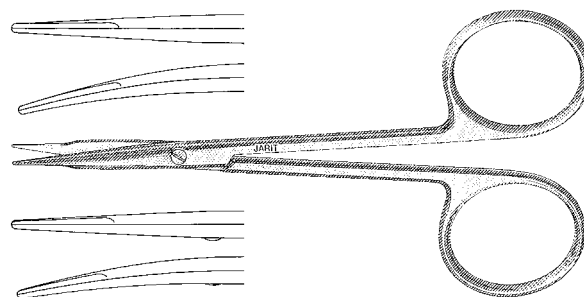

**Stevens Tenotomy Scissors, Blunt-Blunt**

3⅞" (98mm), flat shanks, 13mm blades

Catalog #	Description
360-142	Straight
360-143	Curved

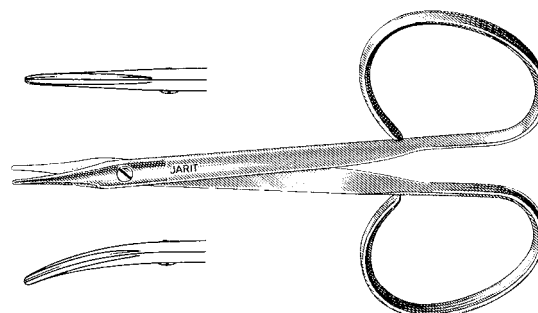

**Stevens Stitch Scissors, Curved Sharp Tips**

Catalog #	Description
360-148	4 1/8" (105mm), 14mm blades

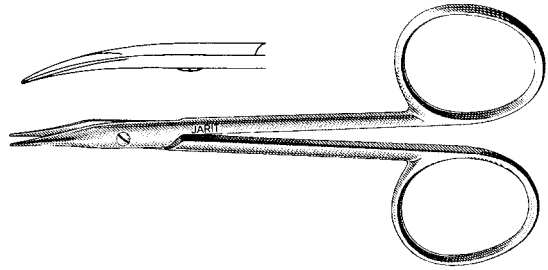

**Stevens Stitch Scissors, Flat Shanks, Curved, Sharp Tips**

Catalog #	Description
360-149	3 7/8" (98mm), 12mm blades

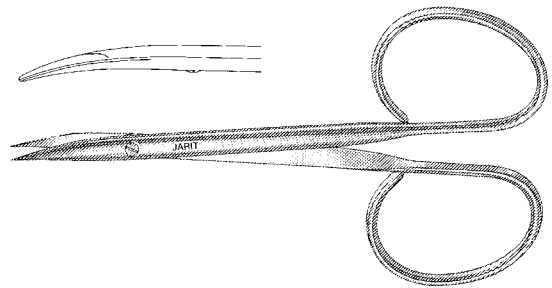

**Stevens Removal Scissors, Flat Shanks, Curved, Fine Sharp Tips**

Catalog #	Description
360-151	4 3/8" (111mm), 12mm blades

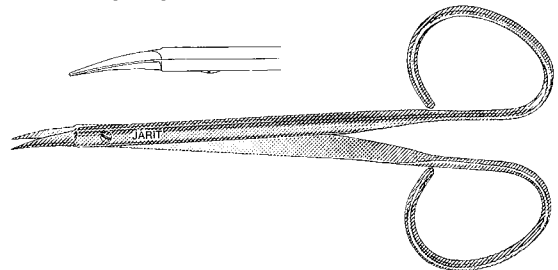

**Enucleation Scissors, Strong Curve**

Catalog #	Description
360-153	5 1/8" (130mm), 32mm blades

**Enucleation Scissors, Light Curve**

Catalog #	Description
360-157	5 1/8" (129mm), 27mm blades

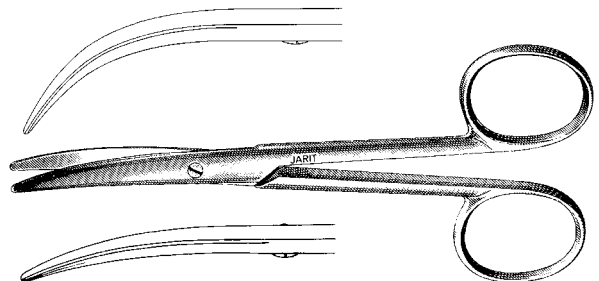



**Stitch Scissors, Semi-Sharp Tips**

3 7/8" (100mm), 16.5mm blades

Catalog #	Description
360-154	Straight
360-155	Curved

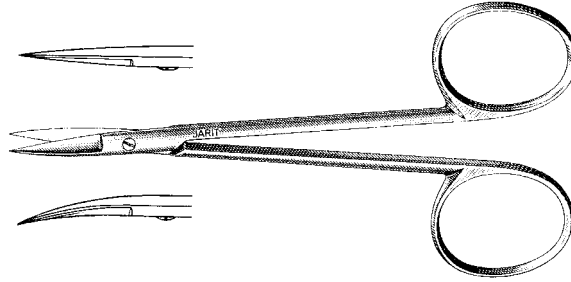

**Gradle Stitch Scissors, Blunt Tips**

Catalog #	Description
360-156	3 3/4" (95mm), 13mm blades

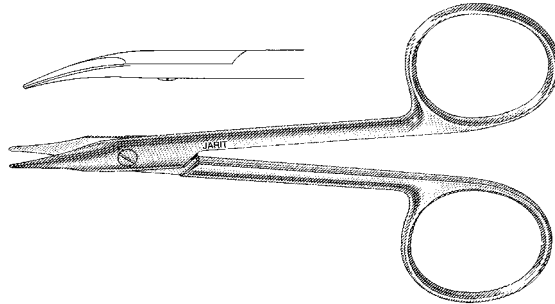

**O'Brien Suture Scissors**

Catalog #	Description
360-195	3 7/8" (100mm), angled

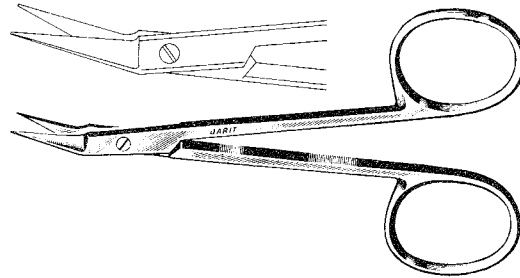

**Seiler Turbinate Scissors**

Catalog #	Description
400-177	6½" (163mm), 72mm blades

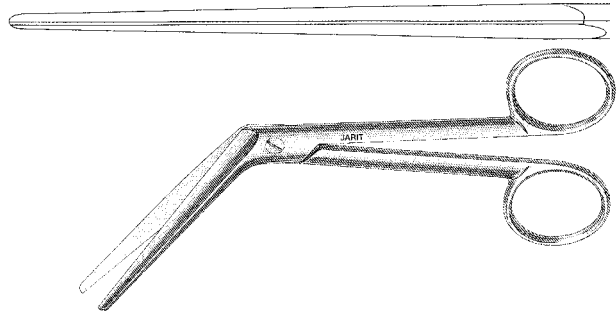

**Knight Nasal Scissors**

Catalog #	Description
400-180	6¼" (161mm), 33mm blades

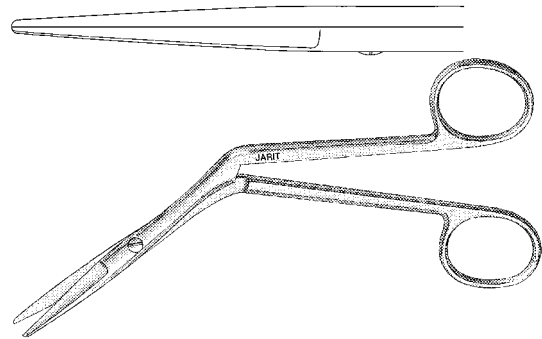

**Ragnell Undermining Scissors**

5¼" (133mm), 17mm flat tip blades

Catalog #	Description
415-100	Straight
415-101	Half-curve
415-102	Full curve

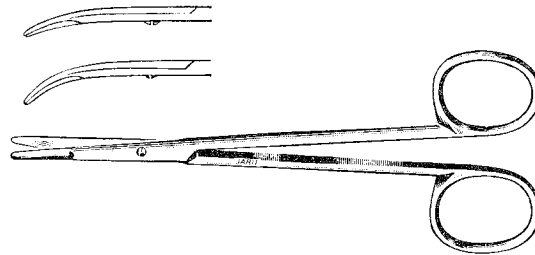

**Cinelli Lower Lateral Scissors, Full Curve**

Catalog #	Description
415-105	4⅝" (116mm)

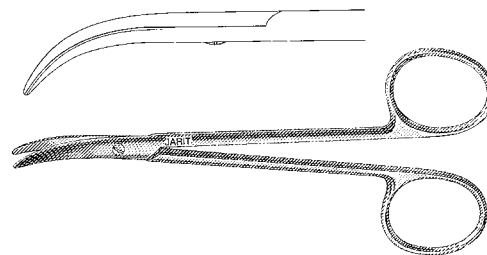

**Fomon Lower Lateral Scissors, Full Curve**

Catalog #	Description
415-110	4½" (114mm), 24mm blades

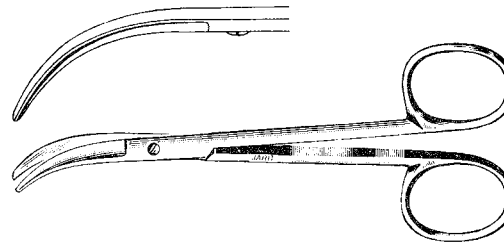

**Lower Lateral Scissors, Full Curve**

Catalog #	Description
415-112	6½" (168mm), 19mm blades

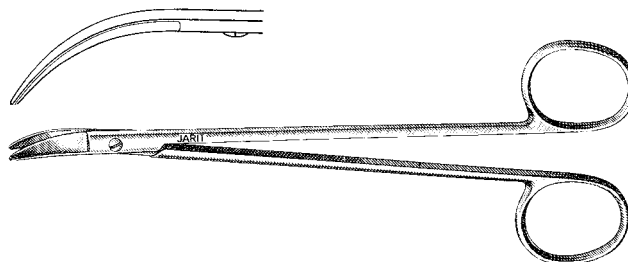

**Dorsal Scissors, Blunt-Blunt**

Catalog #	Description
415-114	4⅝" (119mm), straight, 30mm blades

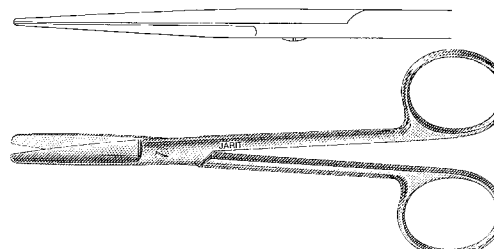

**Fomon Dorsal Scissors, Angled Handles**

Catalog #	Description
415-115	5 <sup>3</sup> / <sub>4</sub> " (146mm), 35mm blades

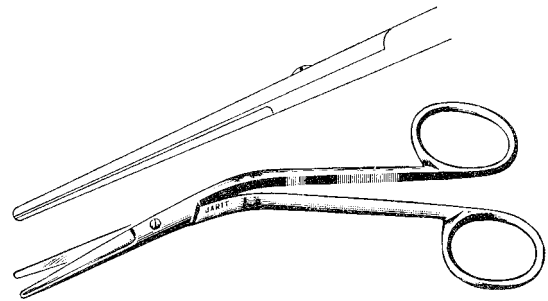

**Goldman Dorsal or Septum Scissors, Angled Handles**

Catalog #	Description
415-116	5 <sup>3</sup> / <sub>4</sub> " (146mm), 40mm serrated blades

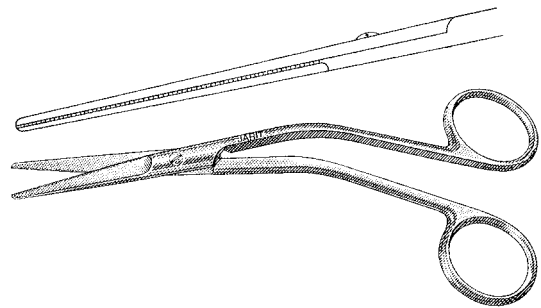

**Cottle Dorsal Scissors, Heavy, Angled Handles**

Catalog #	Description
415-117	5 <sup>3</sup> / <sub>4</sub> " (145mm), 55mm blades

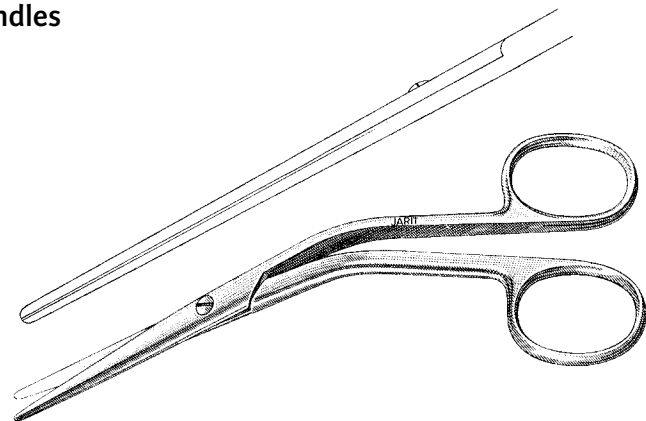

**Caplan Nasal Bone Scissors, Double Action**

Catalog #	Description
415-118	8" (203mm), 22mm serrated blades

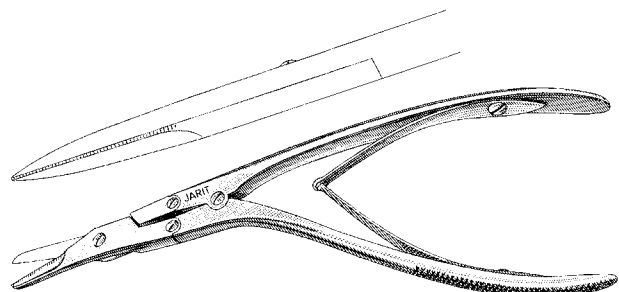

### Cottle Septum Scissors, Angled Handles

Catalog #	Description
415-119	7¼" (187mm), 44mm serrated blades

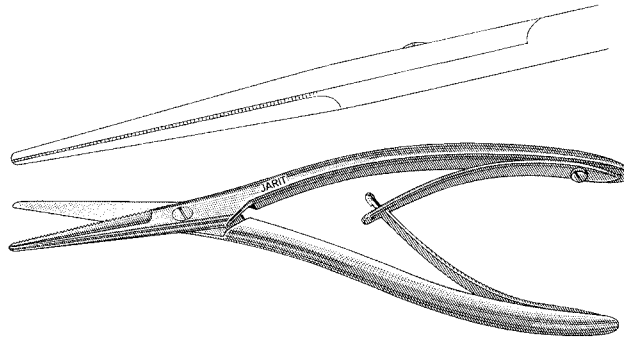

### Miller Dissecting Scissors

Catalog #	Description
415-120	5" (128mm), 32mm semi-sharp outer edge blades

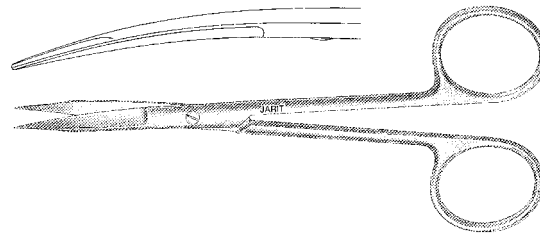

### Kaye Dissecting Scissors, Curved

Catalog #	Description
415-121	4⅛" (106mm), 22mm serrated blades

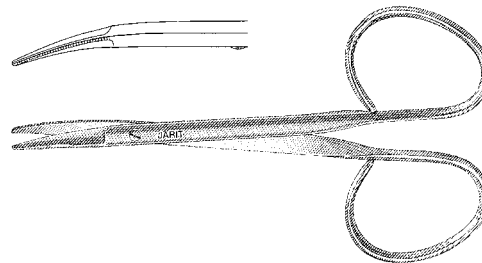

### Fomon Saber Back Scissors, Curved

Catalog #	Description
415-123	5⅜" (136mm), 29mm semi-sharp outer edge blades

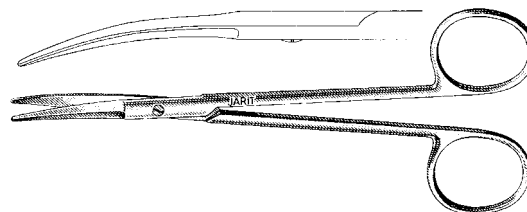

### Goldman Nasal Scissors, Curved

Catalog #	Description
415-124	5⅜" (143mm), 29mm semi-sharp outer edge blades

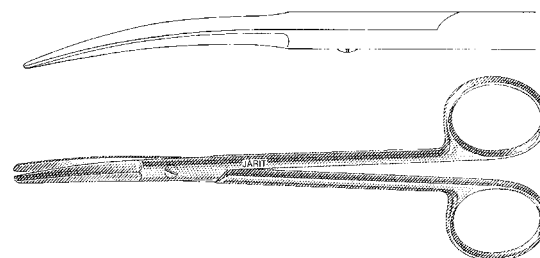

**Aufricht Nasal Scissors, Curved**

Catalog #	Description
415-125	5 <sup>3</sup> / <sub>4</sub> " (146mm), 43mm semi-sharp outer edge blades

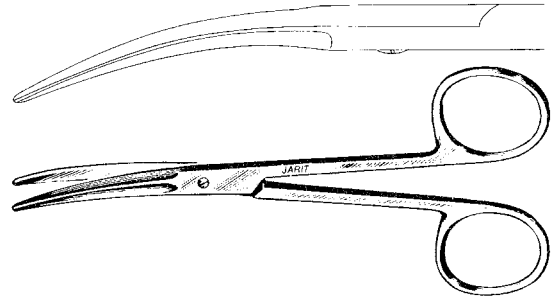

**Jackson Nasal Bone Scissors, Angled, Heavy Pattern**

Catalog #	Description
415-127	7 <sup>3</sup> / <sub>4</sub> " (200mm), 40mm blades

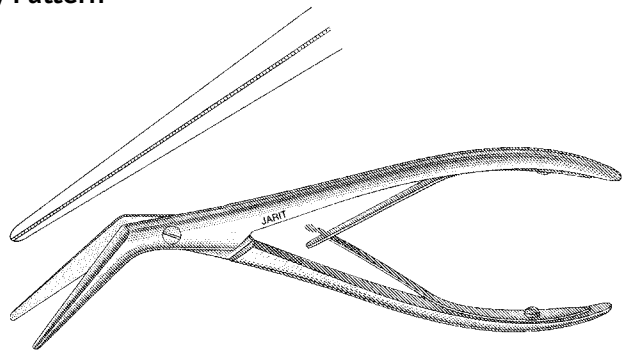

**Becker Septum Scissors, Angled**

Catalog #	Description
415-130	7 <sup>1</sup> / <sub>4</sub> " (183mm), 22mm serrated blades

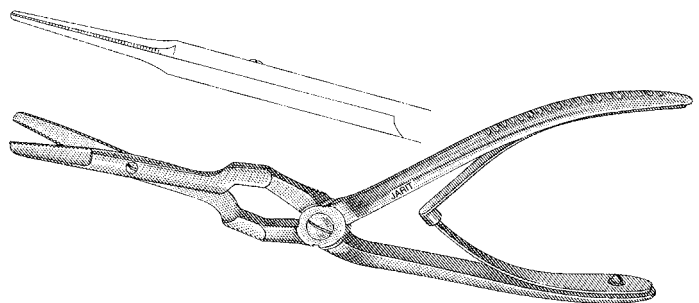

**Gorney Turbinate Scissors, Double Action**

Catalog #	Description
415-133	8 <sup>1</sup> / <sub>4</sub> " (210mm), 40mm serrated blades

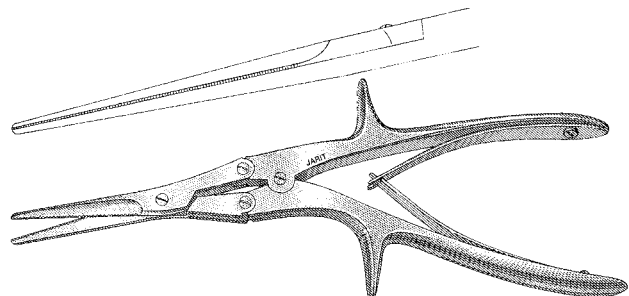

**Brophy Gum and Suture Scissors, Sharp**

5¾" (146mm), 35mm sharp blades

Catalog #	Description
415-140	Straight
415-141	Curved

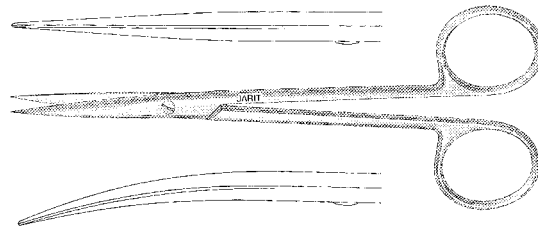

**Littler Suture Carrying Scissors, Curved**

Catalog #	Description
415-145	4¾" (120mm), 22mm blades

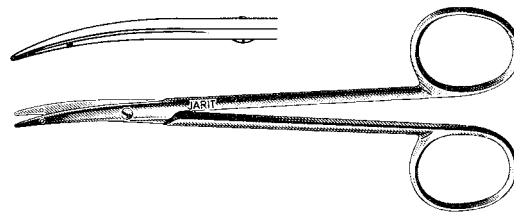

**Brown Dissecting Scissors, Heavy Handles**

5¾" (146mm), 42.5mm narrow blades

Catalog #	Description
415-150	Straight
415-152	Curved

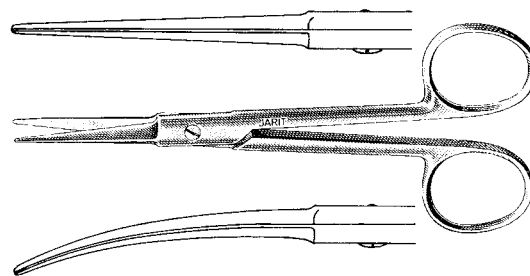

**Brown Dissecting Scissors**

5½" (139mm), 35mm blades

Catalog #	Description
415-170	Straight
415-172	Curved

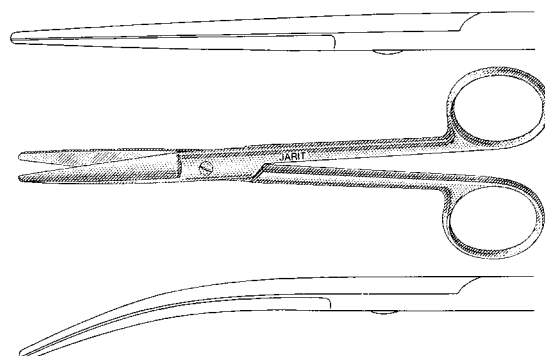

**Dean Tonsil Scissors, Angled**

Catalog #	Description
450-450	7" (175mm), 20mm blades, bottom blade serrated

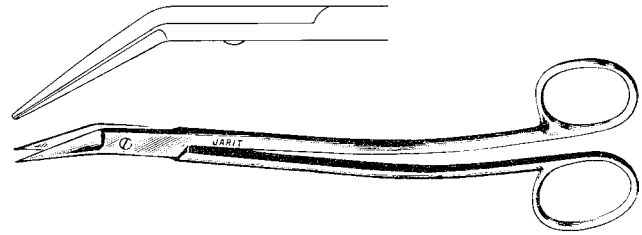

**Boettcher Tonsil Scissors, Curved**

Catalog #	Description
450-455	7 1/4" (184mm), 37mm blades, sharp outer edges

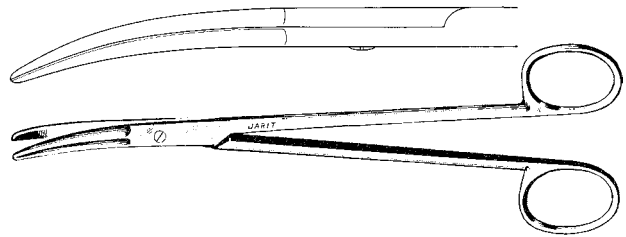

**Lillie Tonsil Scissors, Curved**

Catalog #	Description
450-457	8" (205mm), 40mm blades

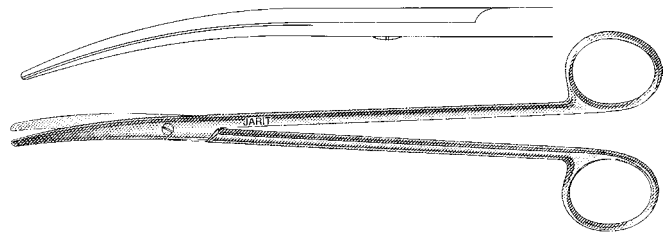

**Boyd Tonsil Scissors, Double Curved**

Catalog #	Description
450-460	7" (177mm), 30mm blades

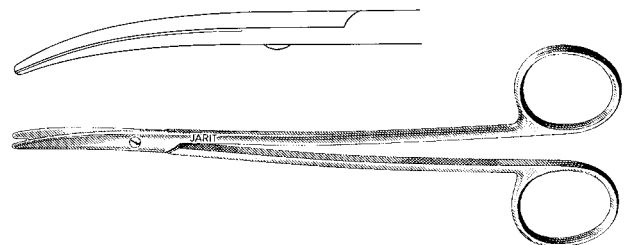



**Sims Uterine Scissors, Straight**

8" (203mm)

Catalog #	Description
505-400	Sharp-sharp, 50mm blades
505-401	Sharp-blunt, 52mm blades
505-402	Blunt-blunt, 50mm blades

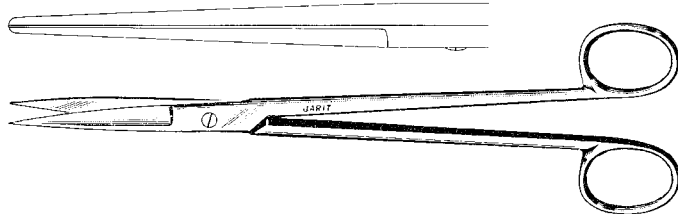

**Sims Uterine Scissors, Curved**

7¾" (200mm)

Catalog #	Description
505-405	Sharp-sharp, 50mm blades
505-406	Sharp-blunt, 51mm blades
505-407	Blunt-blunt, 50mm blades

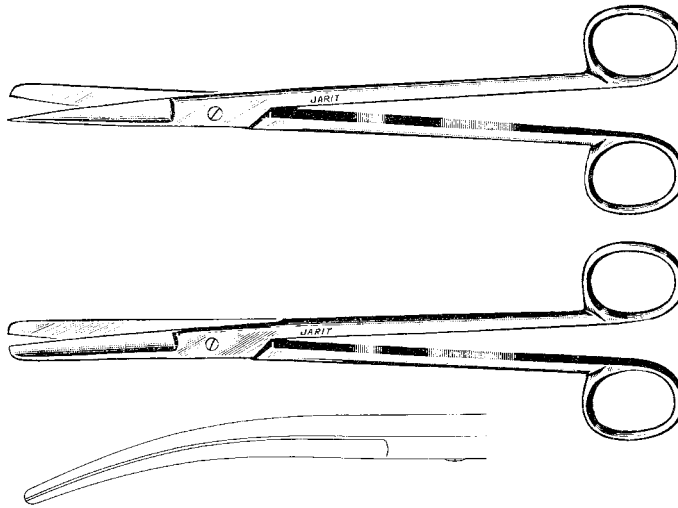

**Braun Episiotomy Scissors**

Catalog #	Description
505-435	5¾" (146mm), 42.5mm blades
505-436	8¾" (222mm), 53.5mm blades

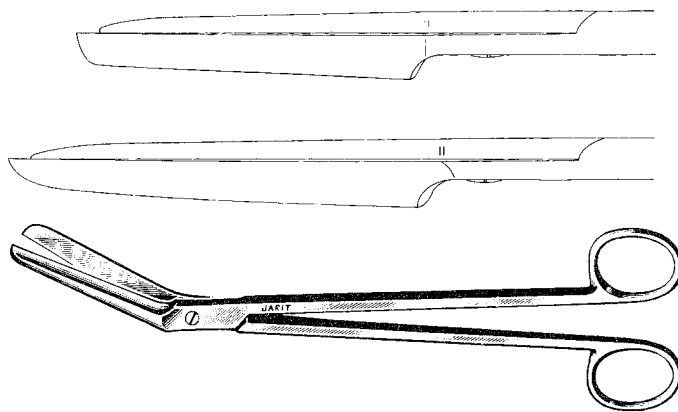

### Carb-Edge™ Scissors

These superbly crafted instruments have a hard tough alloy permanently welded to the scissors and are vacuum hardened. This alloy, composed principally of tungsten, cobalt, chromium and carbon, is harder than stainless steel. Cutting edges of Carb-Edge Scissors are manufactured to ensure instrument durability and longer-lasting blade edge sharpness.

Carb-Edge Scissors are warranted to stay sharp for at least three years of normal usage. If sharpening should be required during the warranty period, it will be done without charge. Finger rings are gold plated for easy identification.



### Operating Scissors, Carb-Edge

Catalog #	Description
101-110	5¾" (145mm), straight, sharp-sharp
101-112	5¾" (145mm), curved, sharp-sharp
101-130	5¾" (145mm), straight, sharp-blunt
101-132	5¾" (145mm), curved, sharp-blunt

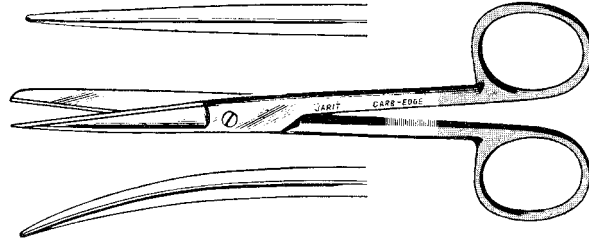

### Mayo Scissors, Round Blades, Carb-Edge, (Satin Finish)

Manufactured from high grade German surgical stainless steel which is ground and polished to a satin finish

Catalog #	Description
101-215	5⅞" (150mm), straight
101-217	5⅞" (150mm), curved
101-218	6¼" (160mm), straight, slender, fine tip
101-219	6¼" (160mm), curved, slender, fine tip
101-220	6¾" (171mm), straight
101-222	6¾" (171mm), curved
101-230	14¼" (361mm), straight
101-232	14¼" (361mm), curved

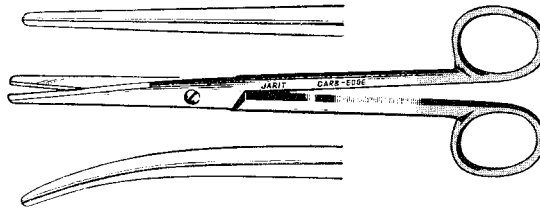

### Mayo Scissors, Round Blades, Carb-Edge (Matte Finish)

Manufactured from high grade German surgical stainless steel which is glass beaded to a matte finish

Catalog #	Description
103-220	6¾" (171mm), straight
103-222	6¾" (171mm), curved

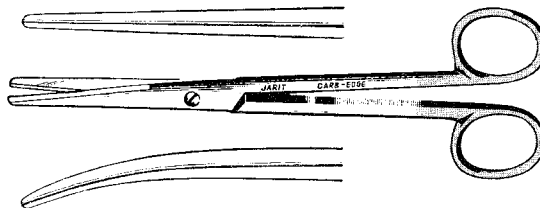

### Mayo-Harrington Scissors, Beveled Blades, Carb-Edge

Catalog #	Description
101-225	9" (230mm), straight
101-226	9" (230mm), curved

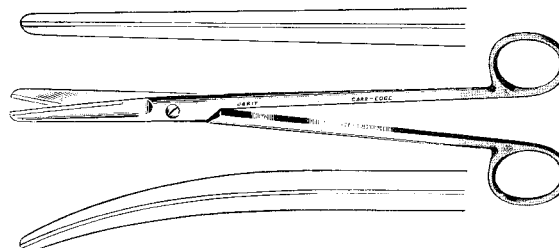

**Metzenbaum-Lahey Scissors, Carb-Edge, (Satin Finish)**

Manufactured from high grade German surgical stainless steel which is ground and polished to a satin finish

Catalog #	Description
101-250	5¾" (145mm), straight
101-251	5¾" (145mm), curved

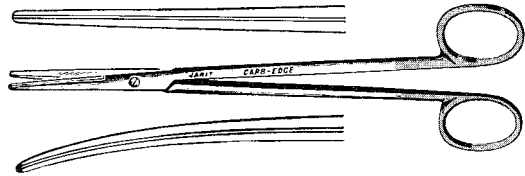

**Metzenbaum-Lahey Scissors, Carb-Edge, (Matte Finish)**

Manufactured from high grade German surgical stainless steel which is glass beaded to a matte finish

Catalog #	Description
103-250	5¾" (145mm), straight
103-251	5¾" (145mm), curved

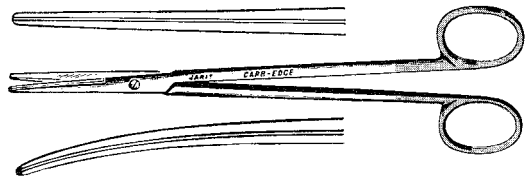

**Metzenbaum-Lahey Scissors, Carb-Edge**

delicate, sharp-sharp

Catalog #	Description
101-252	5¾" (145mm), straight
101-253	5¾" (145mm), curved

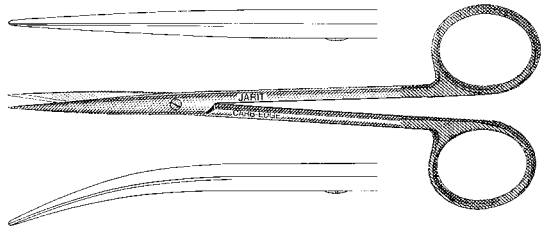

**Petit-Point® Reynolds Scissors, Carb-Edge**

Catalog #	Description
101-255	5⅛" (130mm), curved, one blade serrated

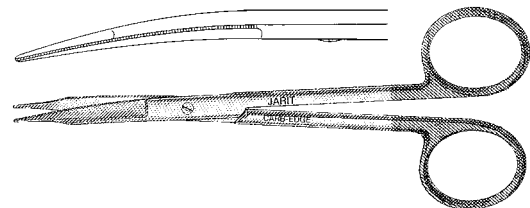

**Metzenbaum Scissors, Carb-Edge, (Satin Finish)**

Manufactured from high grade German surgical stainless steel which is ground and polished to a satin finish

Catalog #	Description
101-258	7" (179mm), curved
101-260	7" (179mm), delicate, straight
101-261	7" (179mm), delicate, curved
101-265	8" (206mm), curved

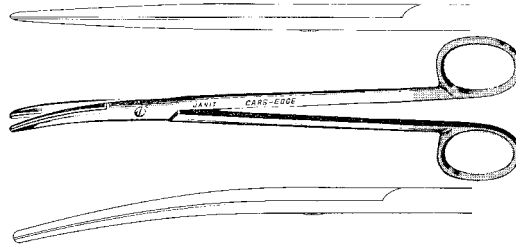

**Metzenbaum Scissors, Carb-Edge, (Matte Finish)**

Manufactured from high grade German surgical stainless steel which is glass beaded to a matte finish

Catalog #	Description
103-258	7" (179mm), curved
103-261	7" (179mm), delicate, curved

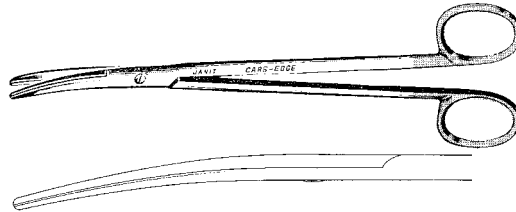

**Metzenbaum-Nelson Scissors, Carb-Edge**

Catalog #	Description
101-266	9¼" (233mm), straight
101-267	9¼" (233mm), curved
101-275	9¼" (233mm), straight, delicate
101-276	9¼" (233mm), curved, delicate
101-269	10¼" (260mm), curved
101-270	11¼" (285mm), curved
101-272	12¼" (310mm), curved
101-256	14¼" (364mm), curved

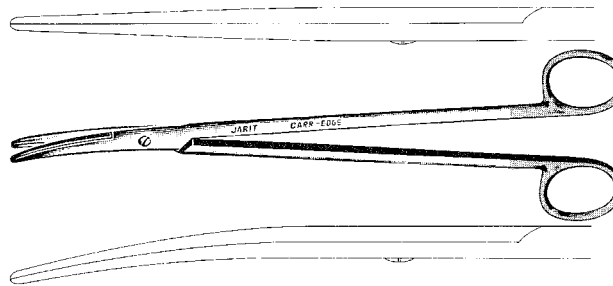

**Metzenbaum Scissors, Carb-Edge**

sharp-sharp

Catalog #	Description
101-257	7" (179mm), straight
101-259	7" (179mm), delicate, curved
101-278	9¼" (233mm), straight
101-279	9¼" (233mm), curved

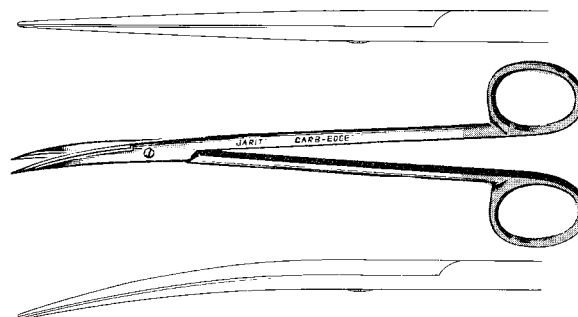

**Iris Scissors, Carb-Edge**

Catalog #	Description
101-300	4½" (114mm), straight
101-301	4½" (114mm), curved

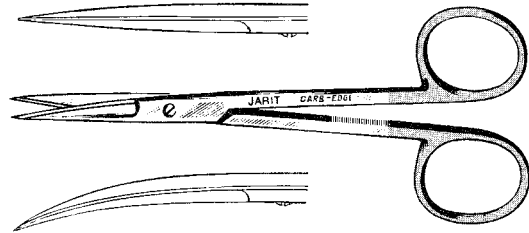

**Strabismus Scissors, Carb-Edge**

Catalog #	Description
101-310	4½" (114mm), straight
101-311	4½" (114mm), curved

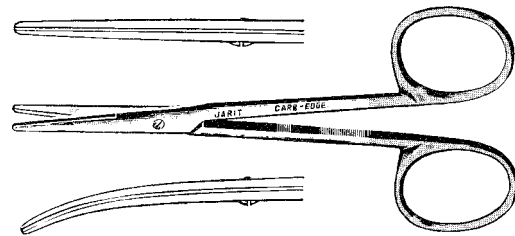

**Universal Wire Suture Scissors, Carb-Edge**

Catalog #	Description
101-350	4⅞" (124mm), angled, for cutting suture and wire (26 gauge and smaller)

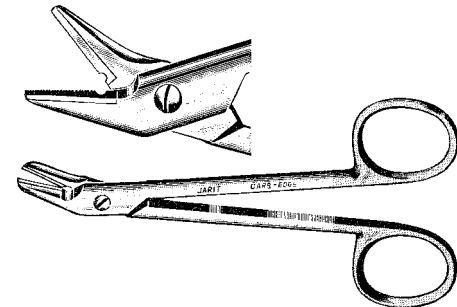

**Parametrium Scissors, Carb-Edge**

Catalog #	Description
505-265	9" (226mm), slight curve, 75mm blades
505-266	8¾" (224mm), curved, 72mm blades
505-267	8½" (219mm), full curved, 70mm blades
505-268	10½" (267mm), slight curve, 75mm blades
505-269	10¼" (260mm), curved, 72mm blades
505-270	10" (255mm), full curve, 70mm blades
505-271	12" (305mm), slight curve, 75mm blades
505-272	11¾" (300mm), curved, 72mm blades
505-273	11½" (295mm), full curve, 70mm blades

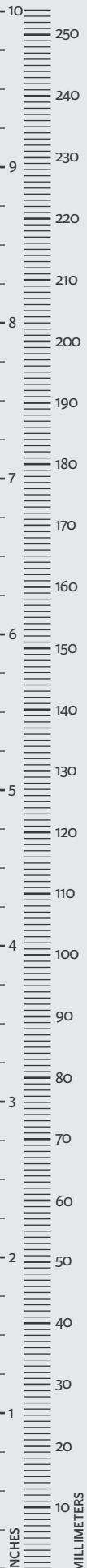
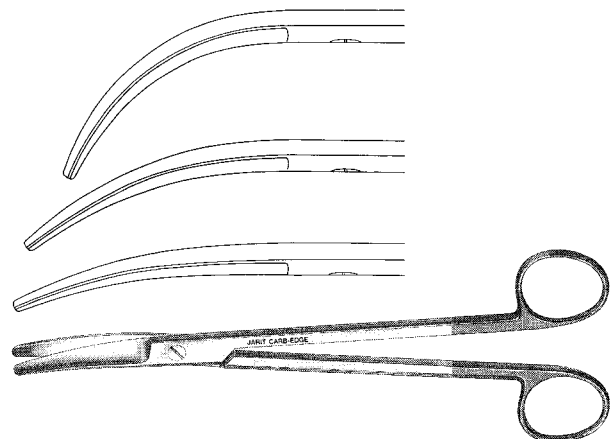

Developed by utilizing unique and innovative methods of grinding, sharpening and heat treating, Jarit Supercut™ scissors have a degree of sharpness greater than on conventional surgical scissors. Finger rings are black plated for easy identification.

All Jarit Supercut Scissors are further warranted for a period of one year under normal usage. Jarit Supercut Scissors will be date stamped for control.

The Jarit Supercut blade is razor sharp and glides effortlessly through tissue with a clean cut. The finely serrated lower blade helps prevent slippage.

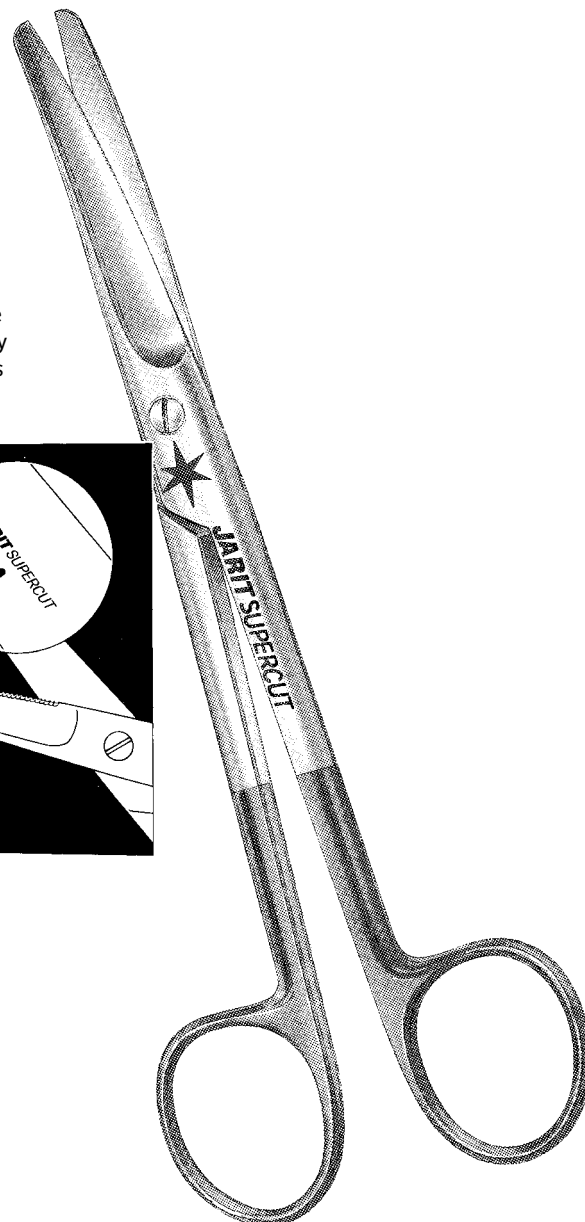
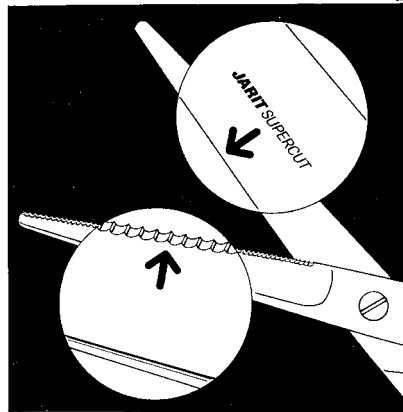

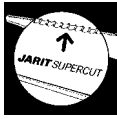

**Mayo Scissors, Supercut**

Catalog #	Description
102-100	5¾" (145mm), straight
102-102	5¾" (145mm), curved
102-110	6¾" (173mm), straight
102-112	6¾" (173mm), curved
102-115	9" (230mm), straight
102-116	9" (230mm), curved
102-113	10" (256mm), straight
102-118	11" (280mm), curved
102-114	12" (305mm), straight

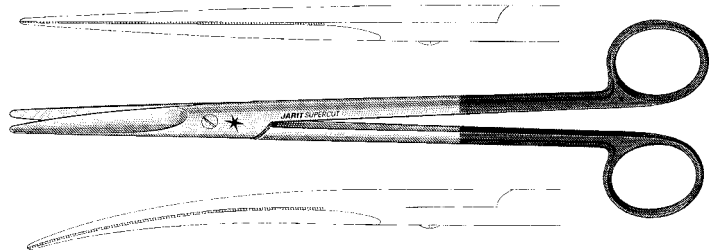
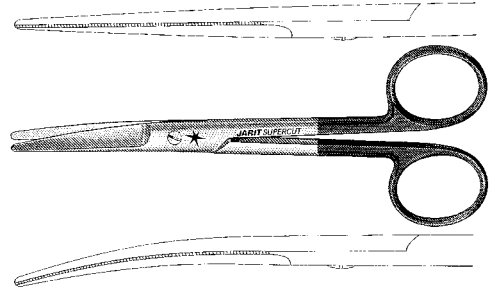

**Metzenbaum-Lahey Scissors, Supercut**

Catalog #	Description
102-119	5⅝" (143mm), straight
102-120	5⅝" (143mm), curved

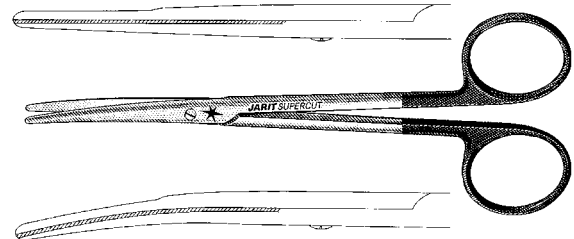

**Metzenbaum Scissors, Supercut**

Catalog #	Description
102-122	7" (180mm), curved
102-125	9¼" (232mm), curved
102-128	11¼" (285mm), curved
102-127	14" (356mm), curved
102-126	10¼" (260mm), curved
102-129	12" (302mm), curved

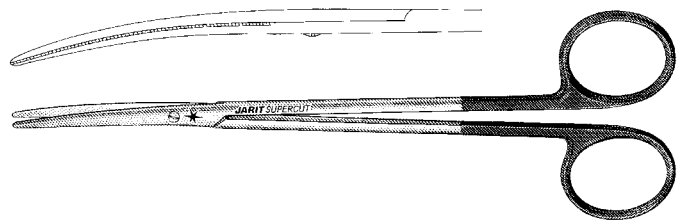



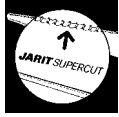

**Iris Scissors, Supercut**

Catalog #	Description
102-130	4 <sup>5</sup> / <sub>8</sub> " (116mm), straight
102-131	4 <sup>5</sup> / <sub>8</sub> " (116mm), curved

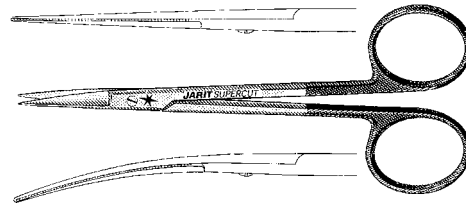

**Knight Nasal Scissors, Supercut**

Catalog #	Description
102-180	6 <sup>1</sup> / <sub>4</sub> " (157mm), angled on the side

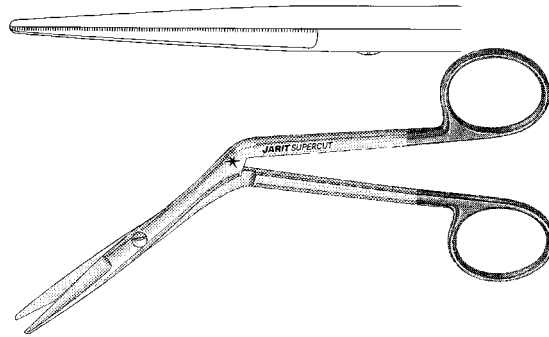

**Plastic Surgery Scissors, Supercut**

Catalog #	Description
102-200	4 <sup>3</sup> / <sub>4</sub> " (121mm), straight
102-202	4 <sup>3</sup> / <sub>4</sub> " (121mm), curved

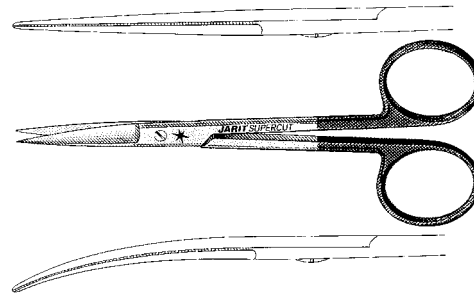

**Stevens Tenotomy Scissors, Supercut**

blunt tips

Catalog #	Description
102-138	4 <sup>3</sup> / <sub>8</sub> " (112mm), 13mm blades, straight, slender pattern
102-139	4 <sup>3</sup> / <sub>8</sub> " (112mm), 13mm blades, curved, slender pattern
102-140	4 <sup>1</sup> / <sub>4</sub> " (107mm), 12mm blades, straight, standard pattern
102-141	4 <sup>1</sup> / <sub>4</sub> " (107mm), 12mm blades, curved, standard pattern

Standard shown below. Supercut available.

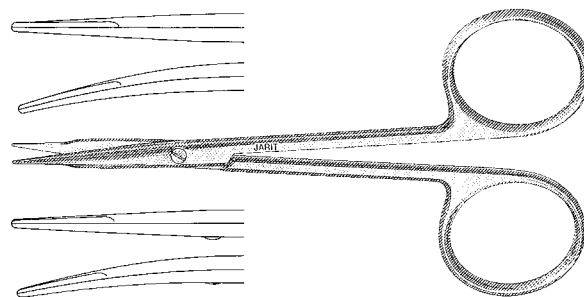

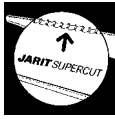

**Castanares Face Lift Scissors, Supercut**

Catalog #	Description
102-205	6 1/4" (157mm), straight

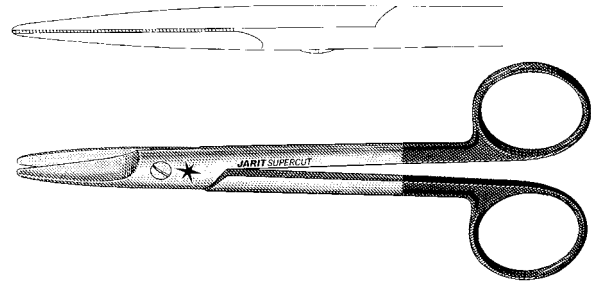

**Gorney Plastic Surgery Scissors, Supercut**

Catalog #	Description
102-210	7 1/4" (185mm), straight
102-211	7 1/4" (185mm), curved

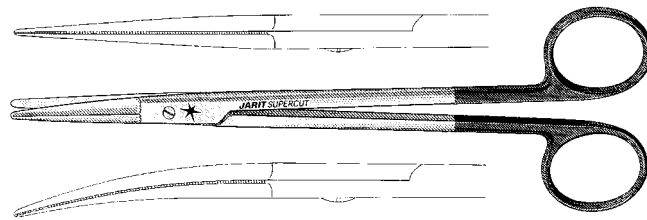

**Kaye Face Lift Scissors, Supercut**  
beveled blades, semi-sharp outer edges

Catalog #	Description
102-215	5 5/8" (142mm), curved
102-216	7 3/4" (194mm), curved

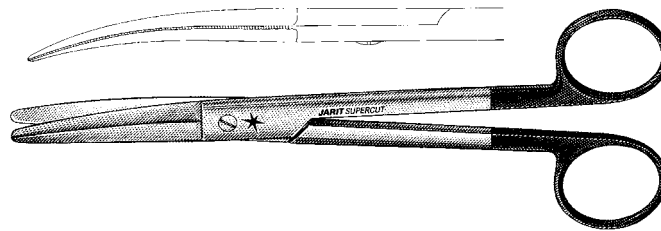

**Freeman-Gorney Face Lift Scissors, Supercut**  
beveled blades, semi-sharp outer edges and flat, tapered tips; flared shanks

Catalog #	Description
102-220	7 1/4" (184mm), straight
102-221	7 1/4" (184mm), curved

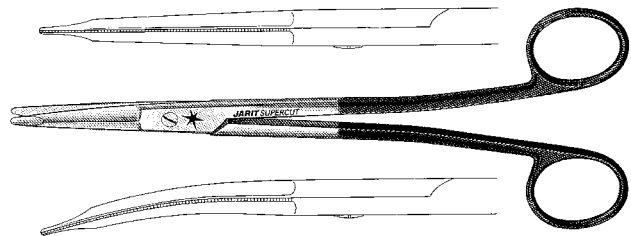

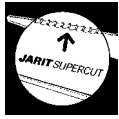

**Freeman-Kaye Face Lift Scissors, Supercut**

beveled blades, semi-sharp outer edges and flat, tapered tips; flared shanks

Catalog #	Description
102-225	7¼" (184mm), straight
102-226	7¼" (184mm), curved

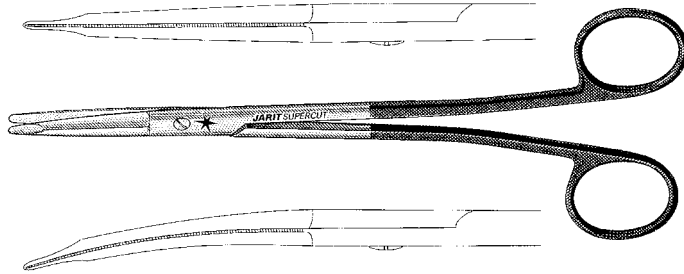

**Freeman Rhytidectomy Scissors, Supercut**

curved flat tips; flared shanks

Catalog #	Description
102-229	7" (178mm)

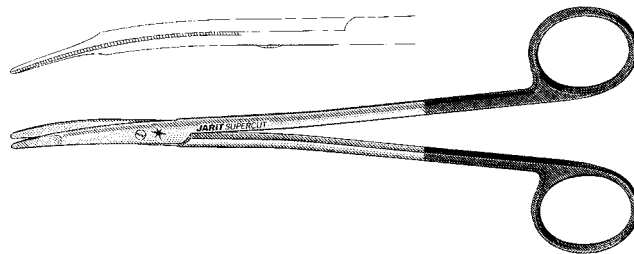

**Gorney Platysma Scissors, Supercut**

beveled blades, semi-sharp outer edges and flat, tapered tips; flared shanks

Catalog #	Description
102-230	9¼" (232mm), straight
102-231	9¼" (232mm), curved

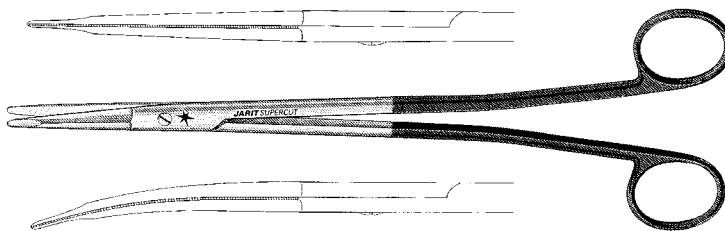

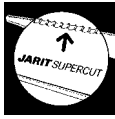

**Fomon Lateral Scissors, Supercut**

Catalog #	Description
102-235	4½" (115mm), full curved

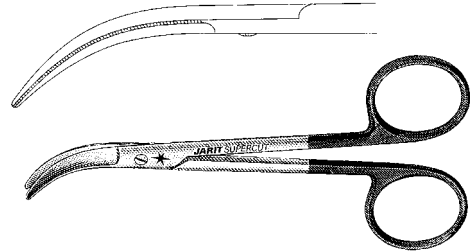

**Fomon Dorsal Scissors, Supercut**

Catalog #	Description
102-236	5¼" (133mm), angled on the flat

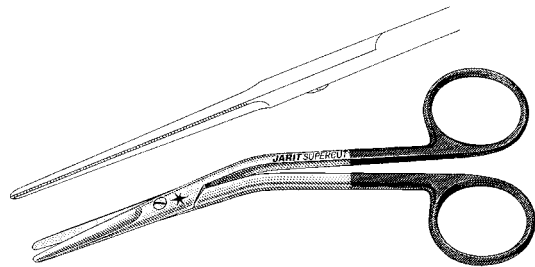

**Cottle Dorsal Scissors, Supercut**

Catalog #	Description
102-238	6" (155mm), angled on flat

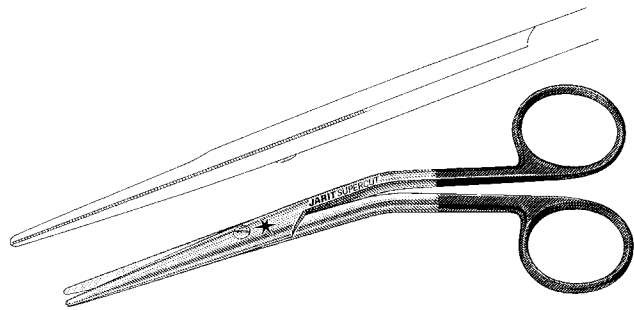

**Par Style Plastic and Recon Scissors, Supercut**

Catalog #	Description
102-240	4½" (113mm), curved
102-242	5⅝" (144mm), curved

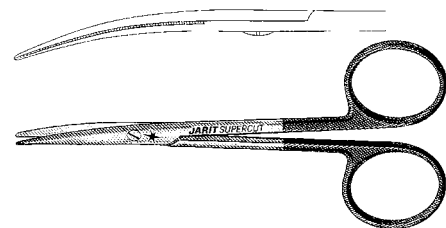

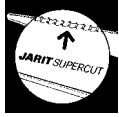

**Reynolds Petit-Point Scissors, Supercut**

Catalog #	Description
102-245	5 1/8" (129mm), curved

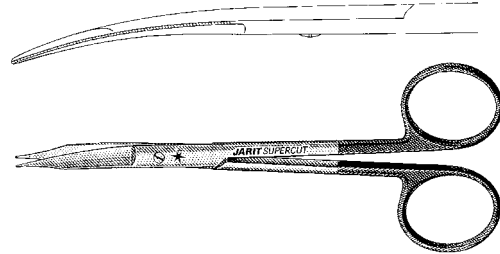

**Jamison Scissors, Supercut**

Catalog #	Description
102-300	5 5/8" (143mm), curved
102-302	7" (180mm), curved

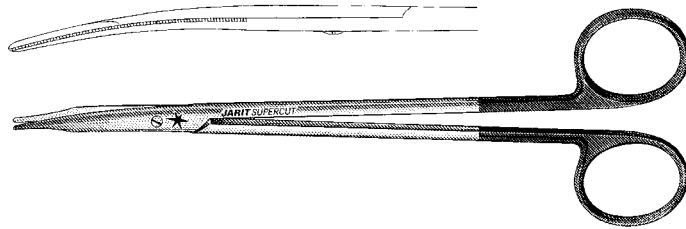

**Lillehei-Potts Scissors, Supercut**  
9" (230mm), 34mm blades

Catalog #	Description
102-305	Curved blades, sharp tips
102-306	Curved blades, blunt tips
102-307	Curved blades, tenotomy tips



**Metzenbaum Scissors, Supercut**  
curved, delicate

Catalog #	Description
102-310	7" (178mm), 33.5mm blades
102-311	7 3/4" (200mm), 32mm blades

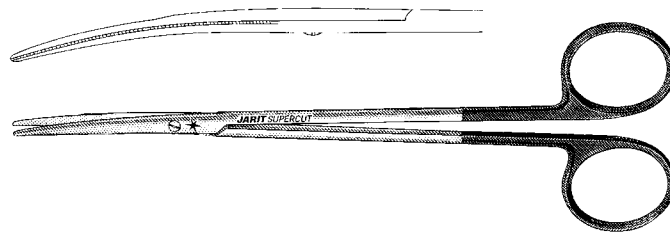

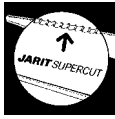

**Stevens Tenotomy Scissors, Supercut**

Catalog #	Description
102-313	7" (178mm), curved, 33mm dissecting tips



**Endarterectomy Scissors, Supercut**

Catalog #	Description
102-315	6¾" (173mm), curved

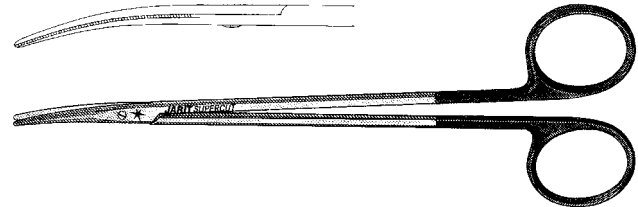

**Potts-Smith Scissors, Supercut**

Catalog #	Description
102-320	25°, 7½" (189mm), 22mm blades
102-321	45°, 7¼" (185mm), 20mm blades
102-322	60°, 7" (180mm), 19mm blades

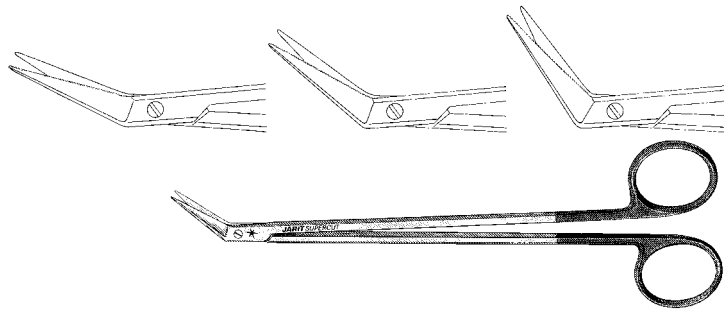

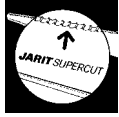

**Diethrich Coronary Artery Scissors, Supercut**

Catalog #	Description
102-350	25°, 7" (182mm), 12mm blades
102-351	45°, 7" (180mm), 13mm blades
102-352	60°, 7" (177mm), 13mm blades
102-353	90°, 7" (170mm), 13.5mm blades
102-354	125°, 7" (172mm), 11mm blades

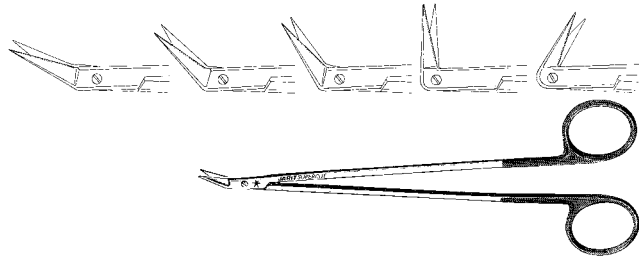

**Diethrich Coronary Artery Scissors, Supercut**

Catalog #	Description
102-360	6¾" (172mm), 130°, 13mm blades shanks are stabilized to keep blades in alignment

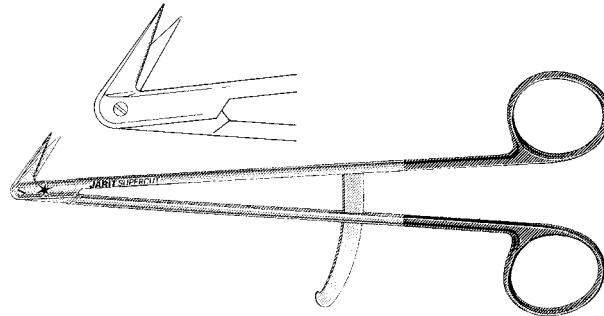

**Favaloro Coronary Artery Scissors, Supercut**

Catalog #	Description
102-374	6¼" (158mm), 125°, 9.5mm blades



Jarit Petit-Point® instruments feature a matched and balanced set of fine, delicate hemostats, soft-tension intestinal clamps, delicate scissors, and needle holders, for pediatric and other delicate procedures.

**Petit-Point Jacobson Mosquito Forceps**

Catalog #	Description
105-088	4 <sup>7</sup> / <sub>8</sub> " (124mm), straight
105-089	4 <sup>7</sup> / <sub>8</sub> " (124mm), curved

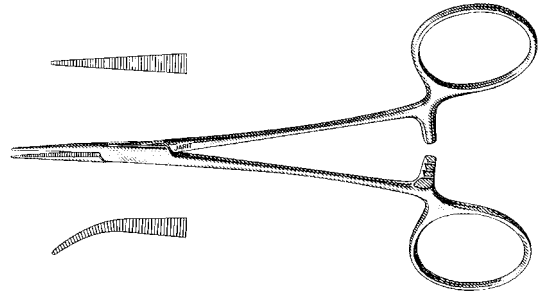

**Petit-Point Jacobson Mosquito Forceps**

Catalog #	Description
105-092	7 <sup>1</sup> / <sub>4</sub> " (185mm), slightly curved
105-093	7 <sup>1</sup> / <sub>4</sub> " (185mm), fully curved



**Petit-Point Mosquito Forceps**

Catalog #	Description
105-090	3 <sup>7</sup> / <sub>8</sub> " (100mm), straight
105-091	3 <sup>7</sup> / <sub>8</sub> " (100mm), curved
105-095	4 <sup>3</sup> / <sub>4</sub> " (120mm), straight
105-096	4 <sup>3</sup> / <sub>4</sub> " (120mm), curved

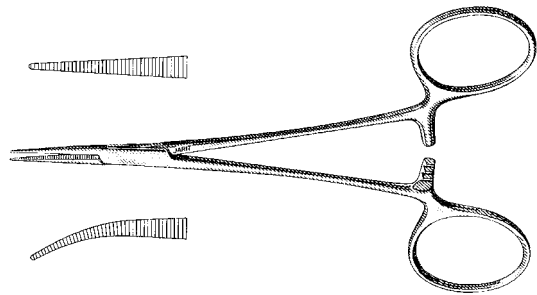

**Petit-Point Mosquito Forceps**

Catalog #	Description
105-098	6" (152mm), straight
105-099	6" (152mm), curved

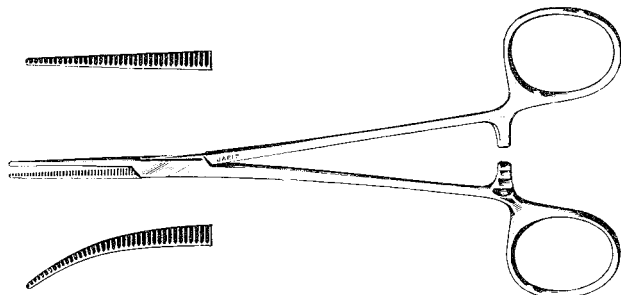



**Petit-Point Mosquito Forceps**

Catalog #	Description
285-107	7¼" (184mm), straight
285-108	7¼" (184mm), curved

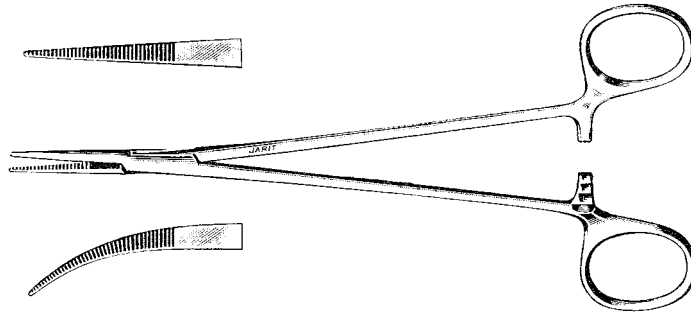

**Petit-Point Crile Forceps**

Catalog #	Description
105-118	5⅝" (143mm), straight
105-119	5⅝" (143mm), curved

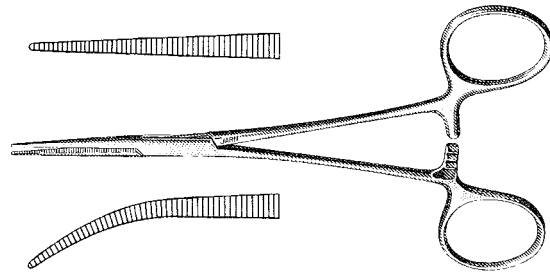

**Petit-Point Pean Forceps**

Catalog #	Description
105-163	5½" (140mm), straight
105-164	5½" (140mm), curved

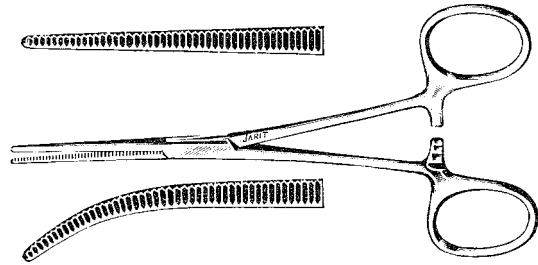

**Petit-Point Ochsner Forceps**

Catalog #	Description
105-233	5½" (140mm), straight
105-234	5½" (140mm), curved

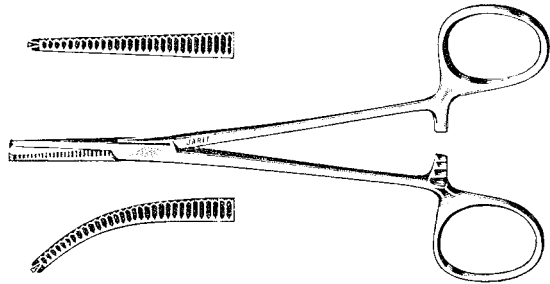

**Petit-Point Reynolds Scissors, Carb-Edge**

Catalog #	Description
101-255	5 1/8" (130mm), curved blades, one blade serrated

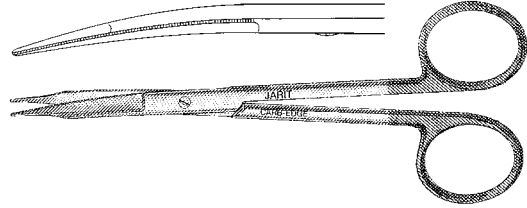

**Petit-Point Olsen-Hegar Needle Holder/Scissors delicate**

Catalog #	Description
120-148	4 3/4" (120mm), serrated
120-149	4 3/4" (120mm), smooth

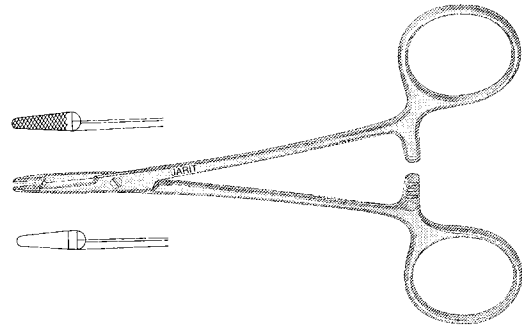

**Petit-Point Olsen-Hegar Needle Holder/Scissors, Carb-Bite**  
7000 teeth per square inch, for use with 6.0, 7.0 and 8.0 suture

Catalog #	Description
121-148	4 3/4" (120mm), delicate, serrated
121-149	4 3/4" (120mm), delicate, smooth

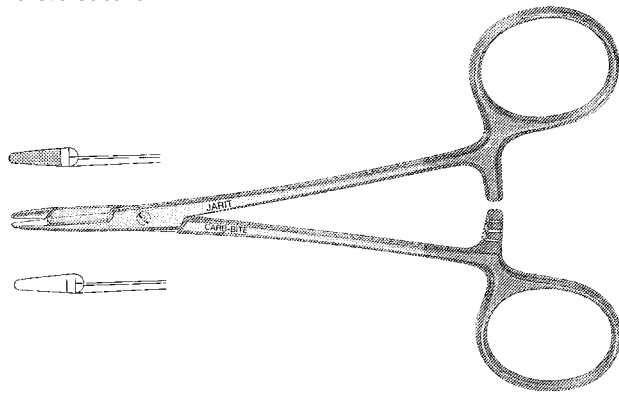

**Petit-Point Ryder Needle Holders, Carb-Bite**

7000 teeth per square inch, for use with 4.0, 5.0 and 6.0 suture serrated jaws

Catalog #	Description
121-170	4 <sup>7</sup> / <sub>8</sub> " (124mm)
121-172	6 <sup>1</sup> / <sub>4</sub> " (156mm)
121-174	7" (176mm)
121-176	7 <sup>3</sup> / <sub>4</sub> " (200mm)
121-177	9" (228mm)

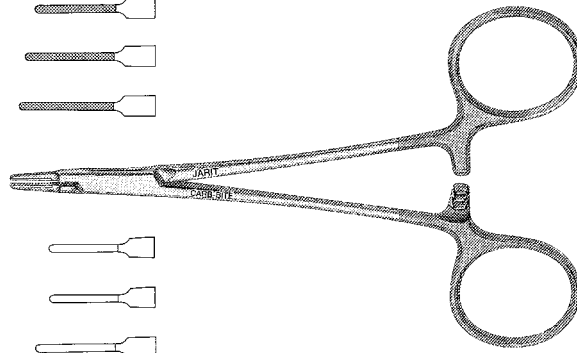
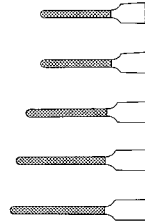

**Petit-Point Ryder Needle Holders, Carb-Bite**

smooth jaws, for use with 4.0, 5.0 and 6.0 suture

Catalog #	Description
121-171	4 <sup>7</sup> / <sub>8</sub> " (124mm)
121-173	6 <sup>1</sup> / <sub>4</sub> " (156mm)
121-175	7" (176mm)
121-179	7 <sup>3</sup> / <sub>4</sub> " (200mm)
121-178	9" (228mm)

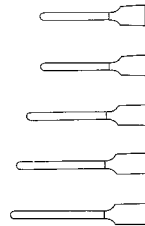

**Petit-Point Sarot Needle Holders, Carb-Bite**

4000 teeth per square inch, for use with 5.0 and 6.0 suture

Catalog #	Description
121-197	5 <sup>7</sup> / <sub>8</sub> " (150mm), delicate
121-198	6 <sup>3</sup> / <sub>4</sub> " (169mm), delicate

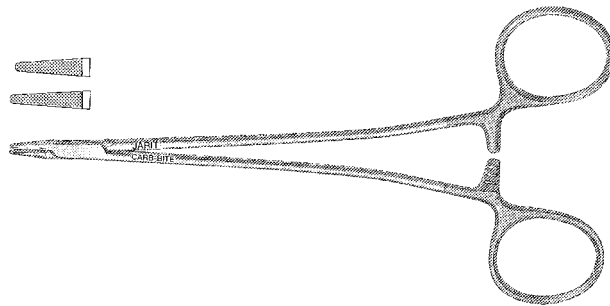

**Petit-Point Allis Tissue Forceps**

Catalog #	Description
135-095	5 1/8" (130mm), 4 x 5 teeth, 3mm wide jaws

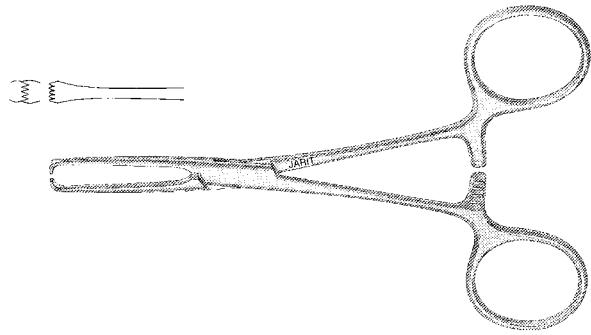

**Petit-Point Babcock Forceps**

Catalog #	Description
135-179	5 7/8" (148mm), jaw width 5.6mm
135-180	6" (155mm), jaw width 7.5mm

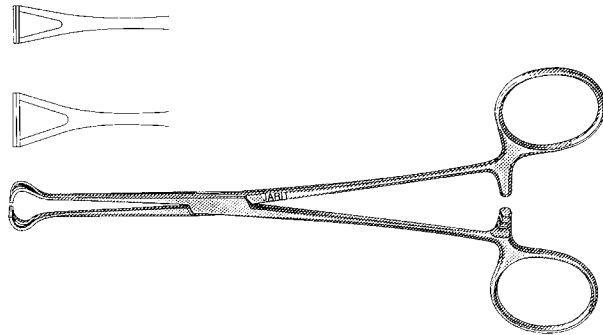

**Petit-Point Mixer Forceps**

Catalog #	Description
140-218	5 3/8" (137mm)

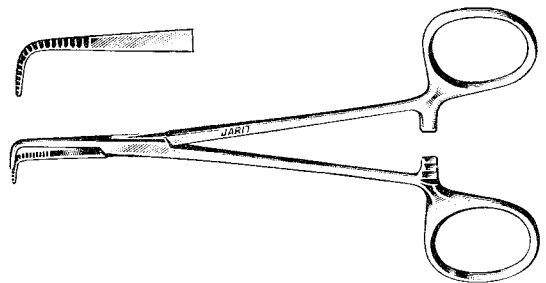

**Petit-Point Mixer Forceps**

Catalog #	Description
140-223	7 1/4" (185mm)

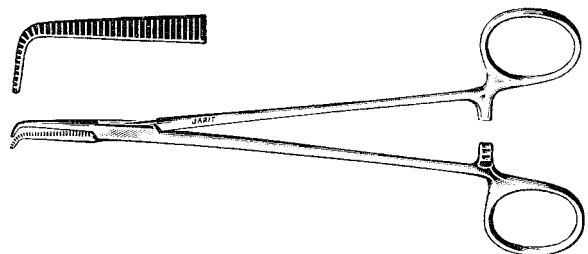

**Halstead Mosquito Forceps, (Mirror Finish)**

Manufactured from high grade German surgical stainless steel which is ground and polished to a mirror finish

Catalog #	Description
105-100	5" (127mm), straight
105-102	5" (127mm), curved

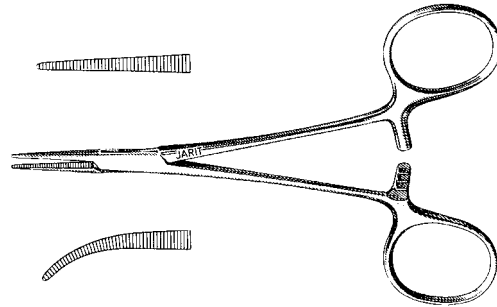

**Halstead Mosquito Forceps, (Satin Finish)**

Manufactured from high grade German surgical stainless steel which is ground and polished to a satin finish

Catalog #	Description
106-100	5" (127mm), straight
106-102	5" (127mm), curved

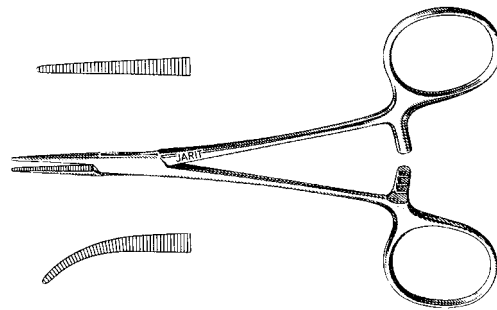

**Halstead Mosquito Forceps, (Matte Finish)**

Manufactured from high grade German surgical stainless steel which is glass beaded to a matte finish

Catalog #	Description
107-100	5" (127mm), straight
107-102	5" (127mm), curved

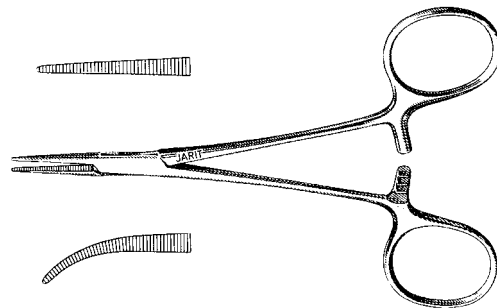

**Halstead Mosquito Forceps**

Catalog #	Description
105-105	4¾" (121mm), angled

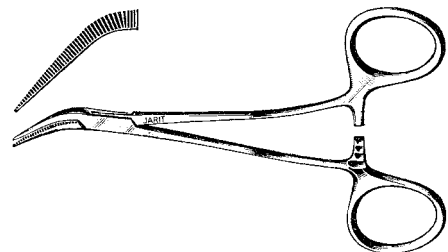

**Halstead Mosquito Forceps**

1 x 2 teeth

Catalog #	Description
105-110	4 <sup>7</sup> / <sub>8</sub> " (124mm), straight
105-112	4 <sup>7</sup> / <sub>8</sub> " (124mm), curved

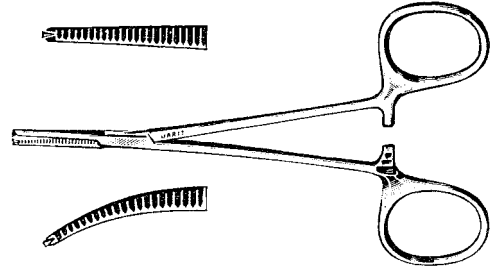

**Hartman Mosquito Forceps, (Mirror Finish)**

Manufactured from high grade German surgical stainless steel which is ground and polished to a mirror finish

Catalog #	Description
105-114	3 <sup>7</sup> / <sub>8</sub> " (100mm), straight
105-115	3 <sup>7</sup> / <sub>8</sub> " (100mm), curved

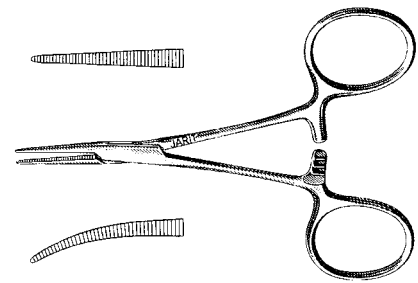

**Hartman Mosquito Forceps, (Matte Finish)**

Manufactured from high grade German surgical stainless steel which is glass beaded to a matte finish

Catalog #	Description
107-114	3 <sup>7</sup> / <sub>8</sub> " (100mm), straight
107-115	3 <sup>7</sup> / <sub>8</sub> " (100mm), curved

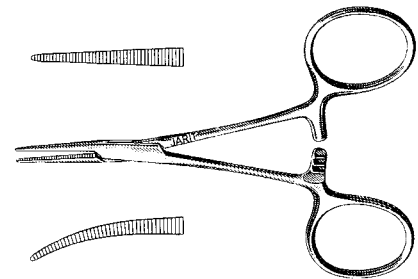

### Crile Artery Forceps, (Mirror Finish)

Manufactured from high grade German surgical stainless steel which is ground and polished to a mirror finish

Catalog #	Description
105-120	5½" (140mm), straight
105-121	5½" (140mm), curved
105-140	6¼" (159mm), straight
105-141	6¼" (159mm), curved

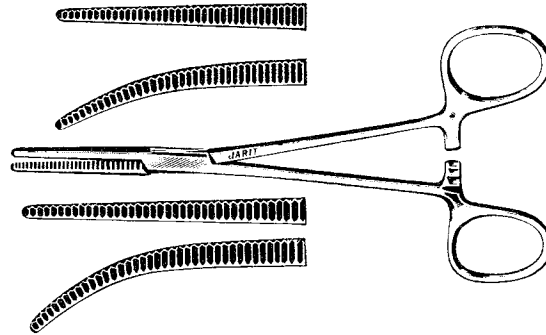

### Crile Artery Forceps, (Satin Finish)

Manufactured from high grade German surgical stainless steel which is ground and polished to a satin finish

Catalog #	Description
106-120	5½" (140mm), straight
106-121	5½" (140mm), curved
106-140	6¼" (159mm), straight
106-141	6¼" (159mm), curved

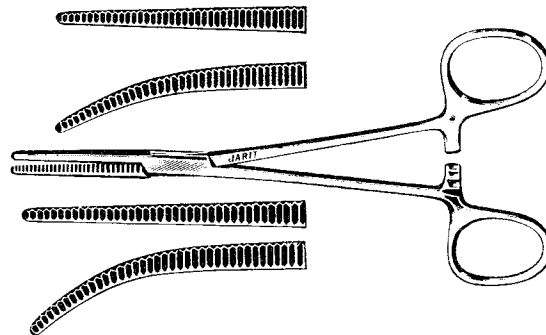

### Crile Artery Forceps, (Matte Finish)

Manufactured from high grade German surgical stainless steel which is glass beaded to a matte finish

Catalog #	Description
107-120	5½" (140mm), straight
107-121	5½" (140mm), curved
107-140	6¼" (159mm), straight
107-141	6¼" (159mm), curved

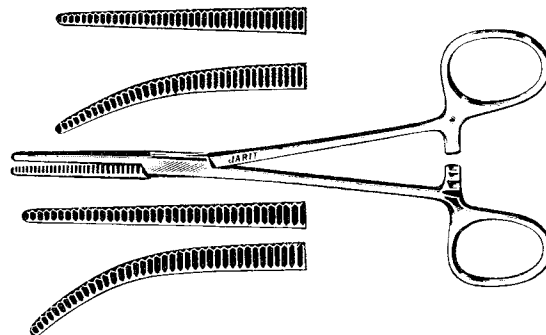

**Kelly Artery Forceps, (Mirror Finish)**

Manufactured from high grade German surgical stainless steel which is ground and polished to a mirror finish

Catalog #	Description
105-130	5½" (140mm), straight
105-131	5½" (140mm), curved

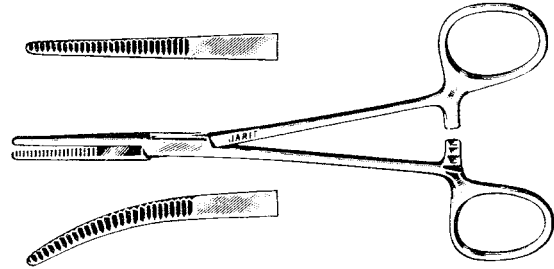

**Kelly Artery Forceps, (Satin Finish)**

Manufactured from high grade German surgical stainless steel which is ground and polished to a satin finish

Catalog #	Description
106-130	5½" (140mm), straight
106-131	5½" (140mm), curved

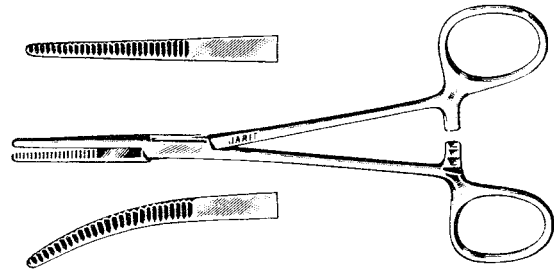

**Kelly Artery Forceps, (Matte Finish)**

Manufactured from high grade German surgical stainless steel which is glass beaded to a matte finish

Catalog #	Description
107-130	5½" (140mm), straight
107-131	5½" (140mm), curved

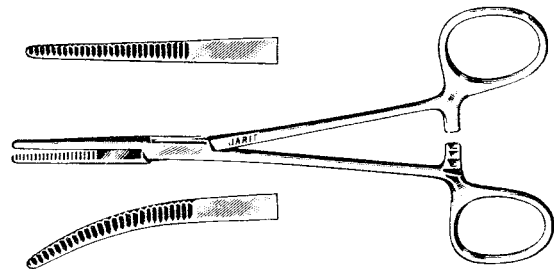

**Coller-Crile Forceps**

fine tapered tips, mirror finish

Catalog #	Description
105-142	5⅝" (143mm), straight
105-143	6¼" (160mm), straight
105-144	5⅝" (143mm), curved
105-145	6¼" (160mm), curved

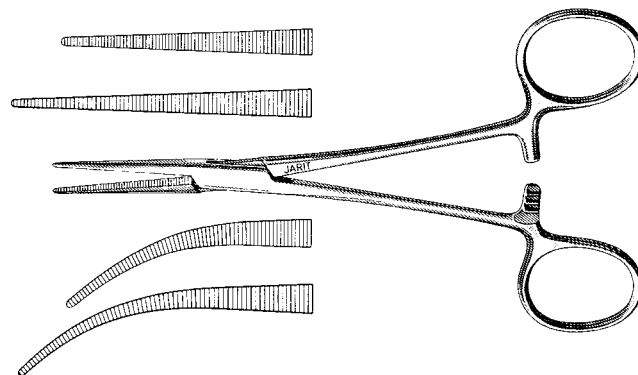



**Rankin Artery Forceps, (Mirror Finish)**

Manufactured from high grade German surgical stainless steel which is ground and polished to a mirror finish

Catalog #	Description
105-150	6¼" (159mm), straight
105-151	6¼" (159mm), curved

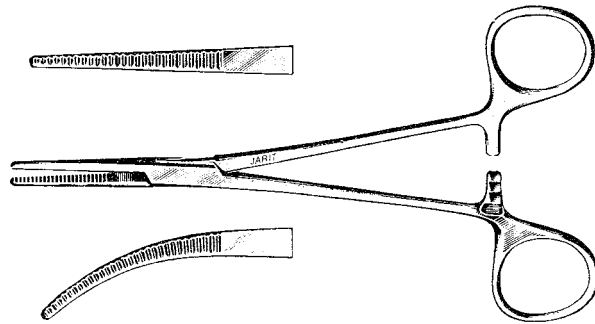

**Rankin Artery Forceps, (Satin Finish)**

Manufactured from high grade German surgical stainless steel which is ground and polished to a satin finish

Catalog #	Description
106-150	6¼" (159mm), straight
106-151	6¼" (159mm), curved

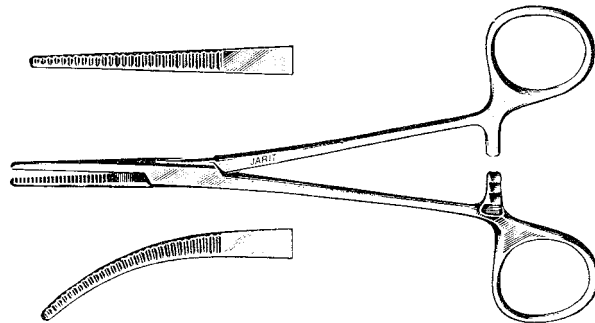

**Providence Hospital Forceps**

Catalog #	Description
105-160	5⅝" (144mm), straight
105-161	5⅝" (144mm), curved

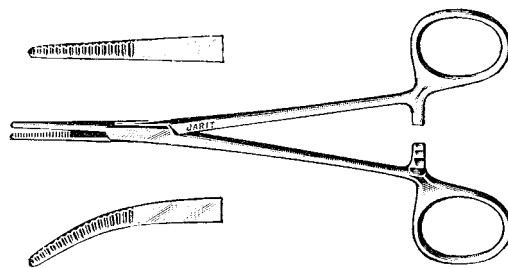

**Rochester-Pean Artery Forceps, (Mirror Finish)**

Manufactured from high grade German surgical stainless steel which is ground and polished to a mirror finish

Catalog #	Description
105-168	5½" (140mm), straight
105-169	5½" (140mm), curved
105-170	6½" (165mm), straight
105-171	6½" (165mm), curved
105-180	7¼" (184mm), straight
105-181	7¼" (184mm), curved
105-190	8" (203mm), straight
105-191	8" (203mm), curved
105-195	8¾" (221mm), straight
105-196	8¾" (221mm), curved
105-197	10" (254mm), straight
105-198	11" (279mm), straight
105-199	12" (305mm), straight

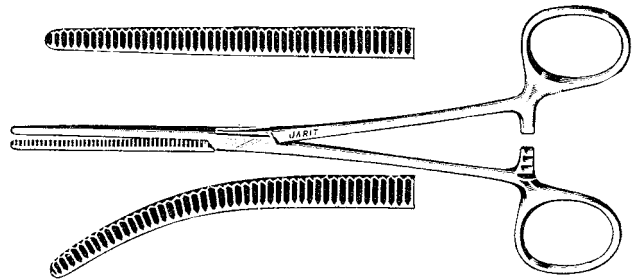

**Rochester-Pean Artery Forceps, (Satin Finish)**

Manufactured from high grade German surgical stainless steel which is ground and polished to a satin finish

Catalog #	Description
106-168	5½" (140mm), straight
106-169	5½" (140mm), curved
106-170	6½" (165mm), straight
106-171	6½" (165mm), curved
106-180	7¼" (184mm), straight
106-181	7¼" (184mm), curved
106-190	8" (203mm), straight
106-191	8" (203mm), curved
106-195	8¾" (221mm), straight
106-196	8¾" (221mm), curved

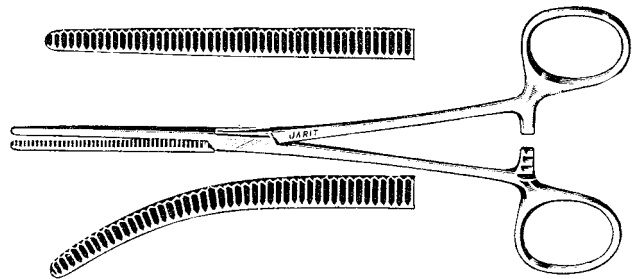

**Rochester-Pean Artery Forceps, (Matte Finish)**

Manufactured from high grade German surgical stainless steel which is glass beaded to a matte finish

Catalog #	Description
107-170	6½" (165mm), straight
107-171	6½" (165mm), curved
107-180	7¼" (184mm), straight
107-181	7¼" (184mm), curved
107-190	8" (203mm), straight
107-191	8" (203mm), curved

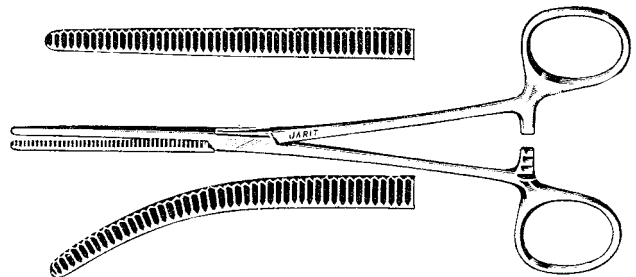

**Rochester-Ochsner Artery Forceps, (Mirror Finish)**

Manufactured from high grade German surgical stainless steel which is ground and polished to a mirror finish

Catalog #	Description
105-200	6¼" (159mm), straight
105-202	6¼" (159mm), curved
105-210	7¼" (184mm), straight
105-212	7¼" (184mm), curved
105-220	7¾" (200mm), straight
105-222	7¾" (200mm), curved
105-223	8¾" (225mm), straight
105-224	8¾" (225mm), curved
105-225	10½" (265mm), straight
105-226	10½" (265mm), curved
105-227	11" (279mm), straight
105-229	12" (305mm), straight
105-228	14" (356mm), straight

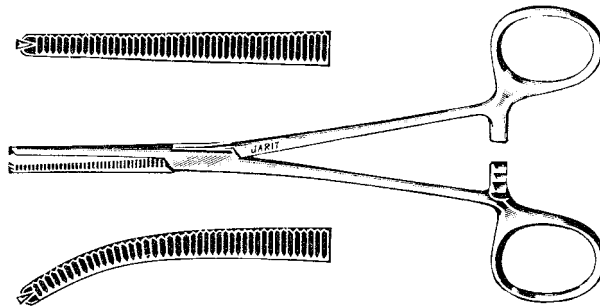

**Rochester-Ochsner Artery Forceps, (Satin Finish)**

Manufactured from high grade German surgical stainless steel which is ground and polished to a satin finish

Catalog #	Description
106-200	6¼" (159mm), straight
106-202	6¼" (159mm), curved
106-210	7¼" (184mm), straight
106-212	7¼" (184mm), curved
106-220	7¾" (200mm), straight
106-222	7¾" (200mm), curved

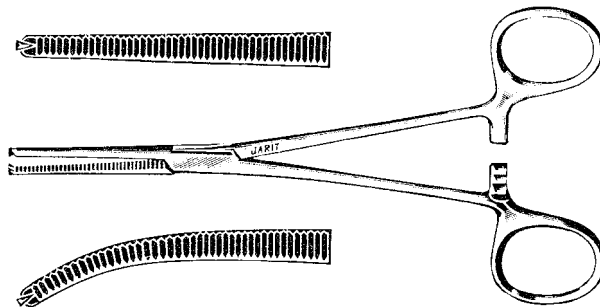

**Rochester-Ochsner Artery Forceps, (Matte Finish)**

Manufactured from high grade German surgical stainless steel which is glass beaded to a matte finish

Catalog #	Description
107-200	6¼" (159mm), straight
107-210	7¼" (184mm), straight
107-220	7¾" (200mm), straight

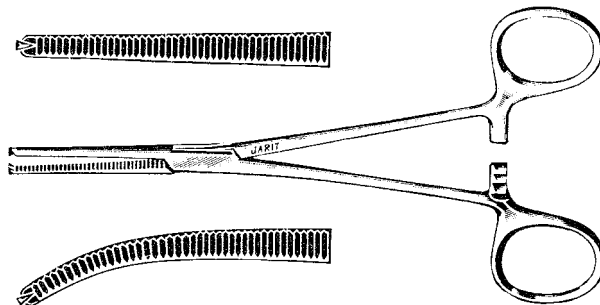

**Kocher Artery Forceps, (Mirror Finish)**

Manufactured from high grade German surgical stainless steel which is ground and polished to a mirror finish

Catalog #	Description
105-230	5½" (140mm), straight
105-232	5½" (140mm), curved

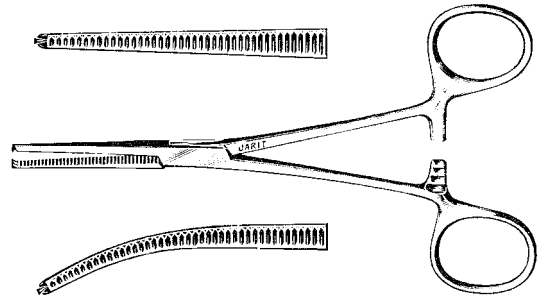

**Kocher Artery Forceps, (Satin Finish)**

Manufactured from high grade German surgical stainless steel which is ground and polished to a satin finish

Catalog #	Description
106-230	5½" (140mm), straight
106-232	5½" (140mm), curved

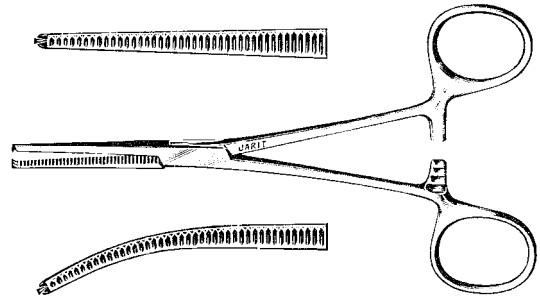

**Rochester-Carmalt Forceps**

Catalog #	Description
105-240	6½" (165mm), straight
105-242	6½" (165mm), curved
105-243	8" (205mm), straight
105-245	8" (205mm), curved

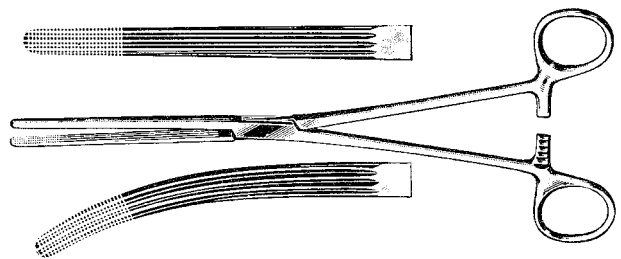

**Jones Forceps**

Catalog #	Description
105-250	5⅞" (131mm), straight
105-251	5⅞" (131mm), curved

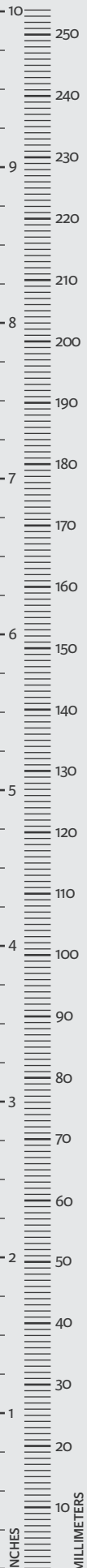
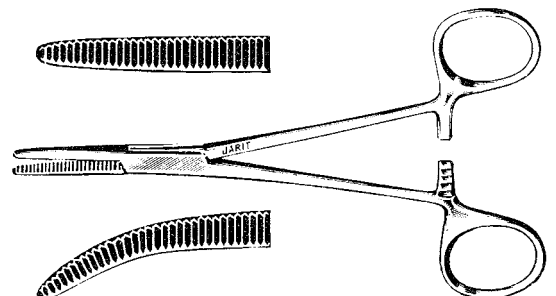

### Pratt-Smith T-Clamp

Catalog #	Description
105-255	5 <sup>7</sup> / <sub>8</sub> " (150mm)

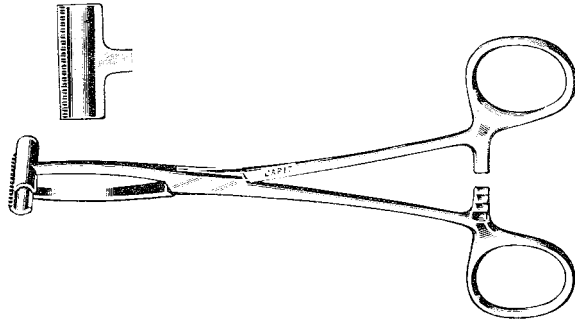

### Diffenbach Serrefines Forceps

Catalog #	Description
105-260	1 <sup>1</sup> / <sub>2</sub> " (37mm), straight
105-261	1 <sup>1</sup> / <sub>2</sub> " (37mm), curved
105-262	2 <sup>3</sup> / <sub>8</sub> " (59mm), straight
105-263	2 <sup>3</sup> / <sub>8</sub> " (59mm), curved

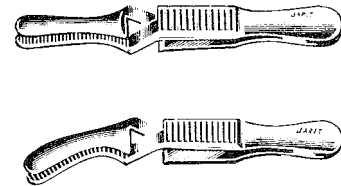

### Ferguson Angiotribes

Catalog #	Description
105-270	6 <sup>1</sup> / <sub>2</sub> " (163mm), straight
105-271	6 <sup>1</sup> / <sub>2</sub> " (163mm), curved

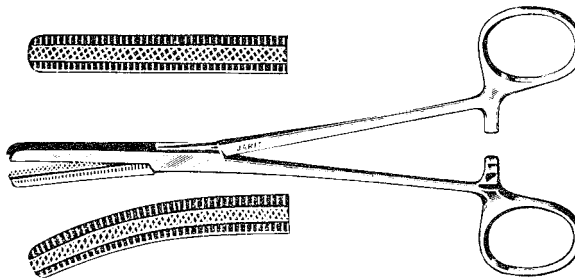

### Bainbridge Forceps, Longitudinal Serrations

Catalog #	Description
105-300	5 <sup>7</sup> / <sub>8</sub> " (150mm), straight, 40mm jaws
105-302	5 <sup>7</sup> / <sub>8</sub> " (150mm), curved, 40mm jaws
105-304	7 <sup>1</sup> / <sub>4</sub> " (185mm), straight, 60mm jaws
105-306	7 <sup>1</sup> / <sub>4</sub> " (185mm), curved, 60mm jaws

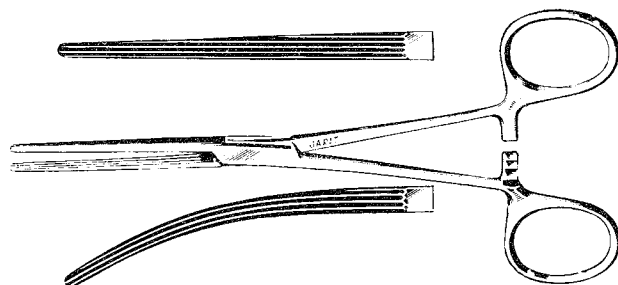

### Bainbridge Forceps

DeBakey serrations

Catalog #	Description
320-228	8" (203mm), straight, delicate, 63mm jaws
320-229	8" (203mm), curved, delicate, 61mm jaws



### Pennington Forceps

Catalog #	Description
105-320	6 1/4" (156mm), 11mm triangular jaws

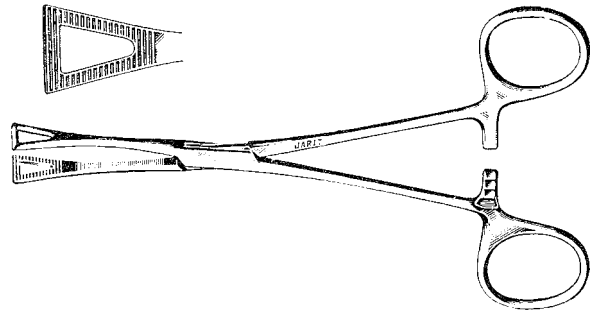

### Coller Artery Forceps, Full Horizontal Serrations

Catalog #	Description
105-330	Curved, 9 1/4" (238mm)
105-331	Strong curve, 9 1/4" (234mm)
105-332	Right angle, 8 3/4" (225mm)



### Storey Artery Forceps, Cross Serrations

Catalog #	Description
105-340	Slight curve, 8 3/4" (222mm)
105-341	Strong curve, 8 3/4" (222mm)
105-342	Right angle, 8 1/2" (214mm)



**Backhaus Towel Forceps, (Mirror Finish)**

Manufactured from high grade German surgical stainless steel which is ground and polished to a mirror finish

Catalog #	Description
110-100	3½" (89mm)
110-102	5¼" (133mm)

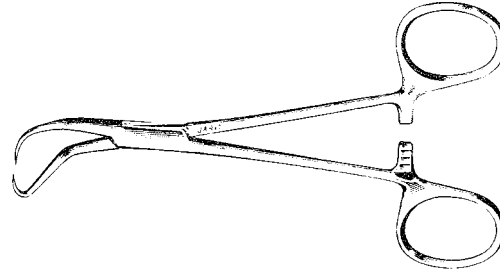

**Backhaus Towel Forceps, (Satin Finish)**

Manufactured from high grade German surgical stainless steel which is ground and polished to a satin finish

Catalog #	Description
111-100	3½" (89mm)
111-102	5¼" (133mm)

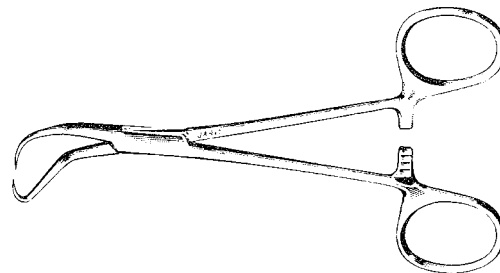

**Backhaus Towel Forceps, (Matte Finish)**

Manufactured from high grade German surgical stainless steel which is glass beaded to a matte finish

Catalog #	Description
109-100	3½" (89mm)
109-102	5¼" (133mm)

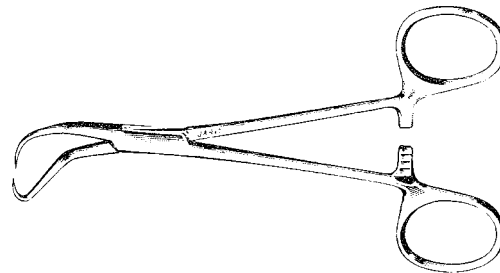

**Roeder Towel Forceps**

Catalog #	Description
110-105	5¾" (135mm)

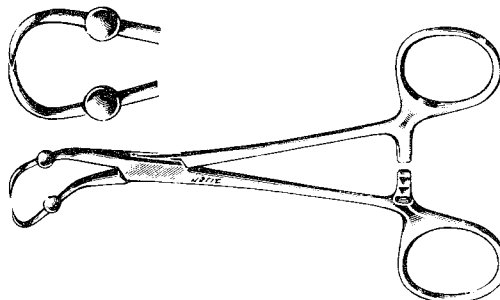

**Jones Towel Forceps**

cross-action

Catalog #	Description
110-110	3 <sup>3</sup> / <sub>8</sub> " (86mm)
110-111	2 <sup>1</sup> / <sub>4</sub> " (56mm)

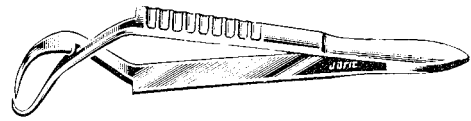

**Non-Perforating Towel Forceps**

Catalog #	Description
110-117	4" (102mm)
110-118	5 <sup>1</sup> / <sub>4</sub> " (132mm)

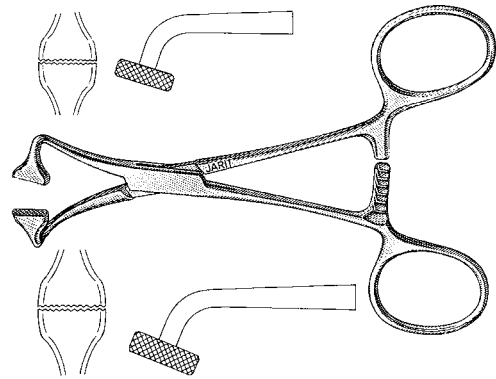



**Edna Towel Forceps, (Mirror Finish)**

Manufactured from high grade German surgical stainless steel which is ground and polished to a mirror finish

Catalog #	Description
110-119	3¾" (96mm)
110-120	5¼" (133mm)

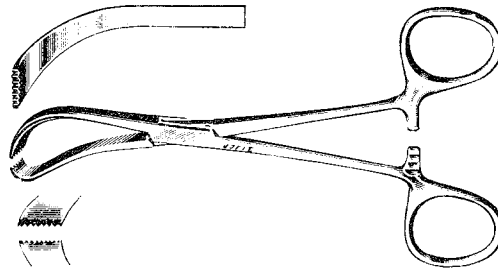

**Edna Towel Forceps, (Matte Finish)**

Manufactured from high grade German surgical stainless steel which is glass beaded to a matte finish

Catalog #	Description
109-119	3¾" (96mm)
109-120	5¼" (133mm)

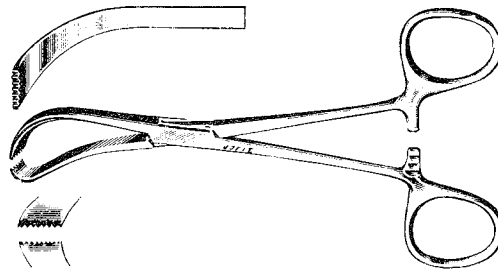

**Peers Towel Forceps**

Catalog #	Description
110-121	5⅝" (144mm)

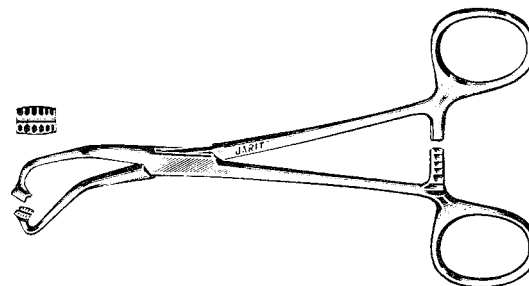

**Presbyterian Hospital Tube Occluding Forceps**

Catalog #	Description
110-150	6½" (165mm)

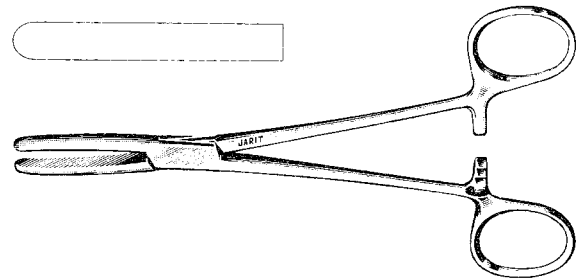

**Tube Occluding Forceps**

delicate jaws with smooth inner surfaces, beveled edges

Catalog #	Description
110-154	5¾" (145mm)

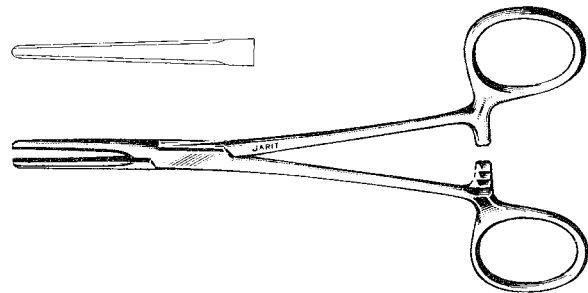

**Vorse Tube Occluding Forceps**

Catalog #	Description
110-155	6" (154mm)
110-157	7½" (189mm)
110-159	8" (204mm), heavy jaw

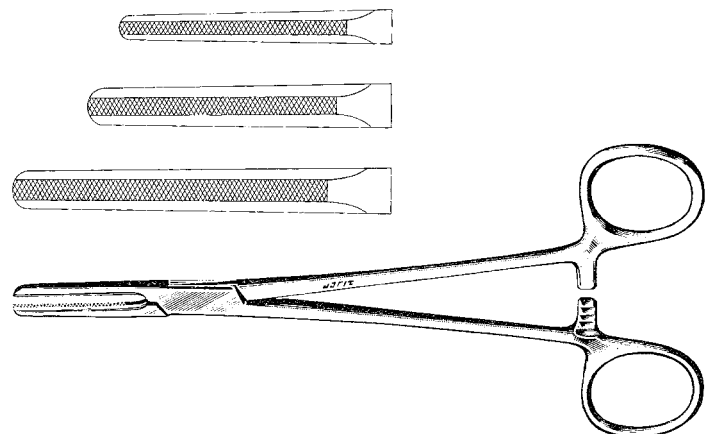

### Tube Occluding Forceps w/U-Shaped Guard

Catalog #	Description
110-160	6" (154mm)
110-161	7½" (189mm)
110-162	8" (204mm), heavy jaw

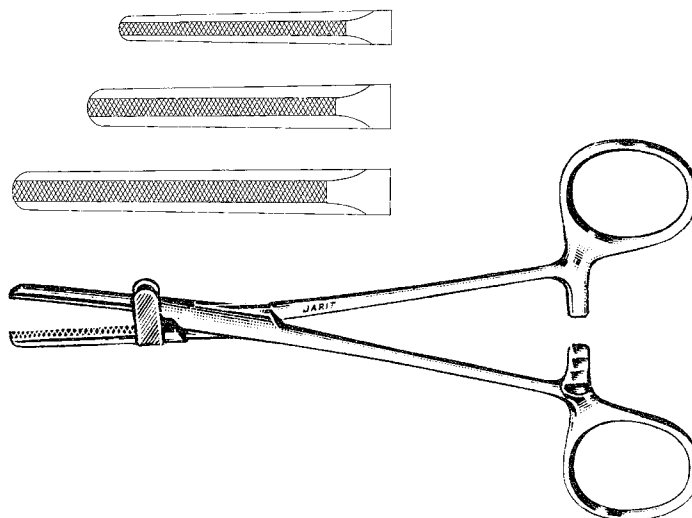

### Safety Blade Remover

Catalog #	Description
110-164	Safety Blade Remover



**Knife Handle #3, with MM and CM Scale, (Satin Finish)**

holds blades 10, 11, 12, 15

Manufactured from high grade German surgical stainless steel which is ground and polished to a satin finish

Catalog #	Description
110-165	4 <sup>7</sup> / <sub>8</sub> " (125mm)



**Knife Handle #3, with MM and CM Scale, (Matte Finish)**

holds blades 10, 11, 12, 15

Manufactured from high grade German surgical stainless steel which is glass beaded to a matte finish

Catalog #	Description
110-175	4 <sup>7</sup> / <sub>8</sub> " (125mm)

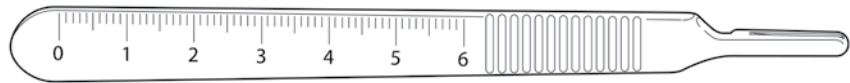

**Knife Handle #4, with MM and CM Scale, (Satin Finish)**

holds blades 20 thru 25

Manufactured from high grade German surgical stainless steel which is ground and polished to a satin finish

Catalog #	Description
110-167	5 <sup>3</sup> / <sub>8</sub> " (135mm)

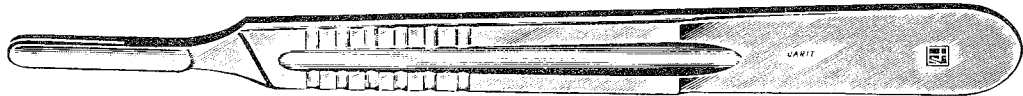

**Knife Handle #4, with MM and CM Scale, (Matte Finish)**

holds blades 20 thru 25

Manufactured from high grade German surgical stainless steel which is glass beaded to a matte finish

Catalog #	Description
110-176	5 <sup>3</sup> / <sub>8</sub> " (135mm)



Supplied with mm and cm scale

**Knife Handle #7, (Satin Finish)**

holds blades 10, 11, 12, 15

Manufactured from high grade German surgical stainless steel which is ground and polished to a satin finish

Catalog #	Description
110-169	6½" (162mm)

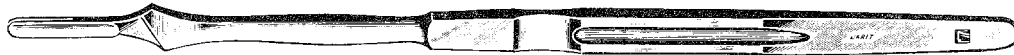

**Knife Handle #7, (Matte Finish)**

holds blades 10, 11, 12, 15

Manufactured from high grade German surgical stainless steel which is glass beaded to a matte finish

Catalog #	Description
110-177	6½" (162mm)



**Knife Handle #3L, (Satin Finish)**

for deep surgery

holds blades 10, 11, 10, 15

Manufactured from high grade German surgical stainless steel which is ground and polished to a satin finish

Catalog #	Description
110-170	8¼" (212mm)



**Knife Handle #3L, (Matte Finish)**

for deep surgery

holds blades 10, 11, 12, 15

Manufactured from high grade German surgical stainless steel which is glass beaded to a matte finish

Catalog #	Description
110-178	8¼" (212mm)



**Knife Handle #3LA**

angled, for deep surgery  
holds blades 10, 11, 12, 15

Catalog #	Description
110-171	8¼" (212mm), satin



**Knife Handle #4L**

for deep surgery  
holds blades 20 thru 25

Catalog #	Description
110-173	8¼" (212mm)



**Knife Handle #9 (7K)**

holds blades 10, 11, 12, 15

Catalog #	Description
110-174	4¾" (120mm)



**Barron Knife Handle**

octagonal handle  
holds blades 10, 11, 12, 15

Catalog #	Description
110-180	5½" (140mm)



**Corwin Knife Handle**

round knurled handle  
holds blades 10, 11, 12, 15

Catalog #	Description
110-182	6" (152mm)

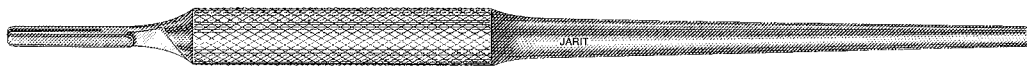

**Knife Handle**

round knurled handle  
holds miniature blades (e.g. series 50, 60, 70)

Catalog #	Description
110-190	#3KS, 3 <sup>5</sup> / <sub>8</sub> " (93mm)
110-191	#3KL, 5 <sup>7</sup> / <sub>8</sub> " (150mm)
110-198	#3K/H replacement collet



**Knife Handle**

hexagonal handle  
holds miniature blades (e.g. series 50, 60, 70)

Catalog #	Description
110-194	#3HS, 4 <sup>1</sup> / <sub>8</sub> " (106mm)
110-195	#3HL, 6 <sup>1</sup> / <sub>4</sub> " (157mm)
110-198	#3K/H replacement collet



**Foerster Sponge Holding Forceps, (Mirror Finish)**

Manufactured from high grade German surgical stainless steel which is ground and polished to a mirror finish

Catalog #	Description
115-100	7" (178mm), straight, smooth
115-102	7" (178mm), straight, serrated
115-105	9½" (241mm), straight, smooth
115-107	9½" (241mm), straight, serrated
115-110	7" (178mm), curved, smooth
115-112	7" (178mm), curved, serrated
115-115	9½" (241mm), curved, smooth
115-117	9½" (241mm), curved, serrated

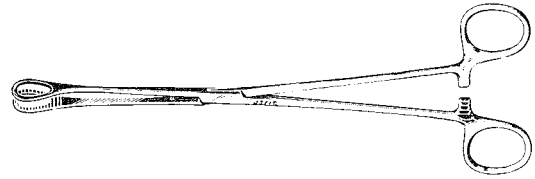

**Foerster Sponge Holding Forceps, (Satin Finish)**

Manufactured from high grade German surgical stainless steel which is ground and polished to a satin finish

Catalog #	Description
116-100	7" (178mm), straight, smooth
116-102	7" (178mm), straight, serrated
116-105	9½" (241mm), straight, smooth
116-107	9½" (241mm), straight, serrated
116-110	7" (178mm), curved, smooth
116-112	7" (178mm), curved, serrated
116-115	9½" (241mm), curved, smooth
116-117	9½" (241mm), curved, serrated

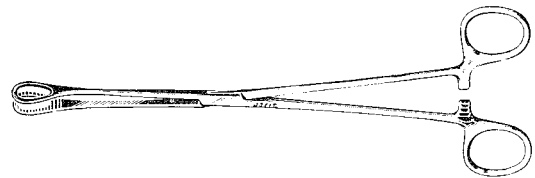



**Foerster Sponge Holding Forceps, (Matte Finish)**

Manufactured from high grade German surgical stainless steel which is glass beaded to a matte finish

Catalog #	Description
114-102	7" (178mm), straight, serrated
114-107	9½" (241mm), straight, serrated
114-124	14" (357mm), straight, serrated

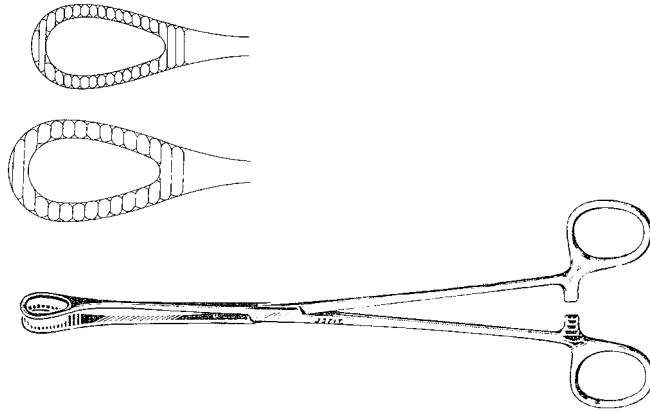

**Fletcher Sponge Forceps**

Catalog #	Description
115-119	9¾" (245mm), straight
115-120	9¾" (245mm), curved

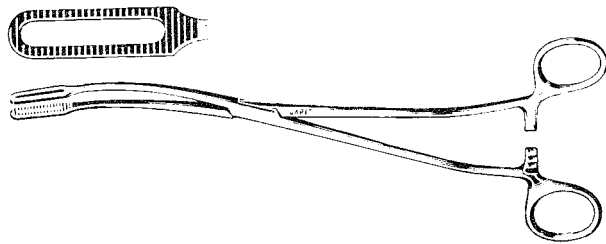

**Converse Needle Holder**

Catalog #	Description
120-090	4 <sup>3</sup> / <sub>8</sub> " (112mm), large finger rings

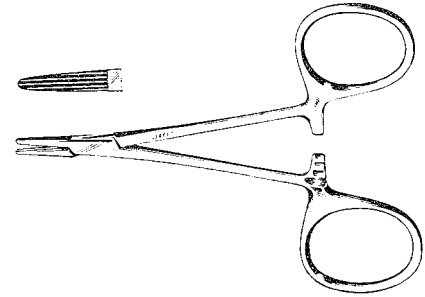

**Brown Needle Holder**

Catalog #	Description
120-095	5 <sup>1</sup> / <sub>4</sub> " (133mm), rounded jaws

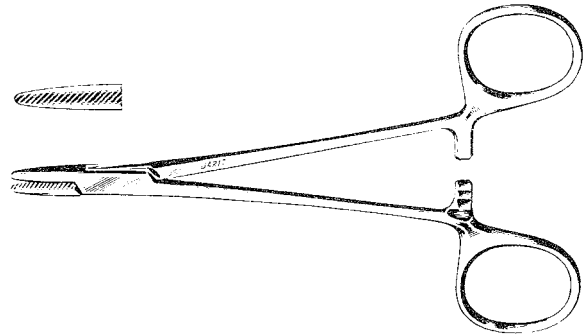

**Neivert Needle Holder**

Catalog #	Description
120-097	4 <sup>7</sup> / <sub>8</sub> " (123mm), thumb ring turned up

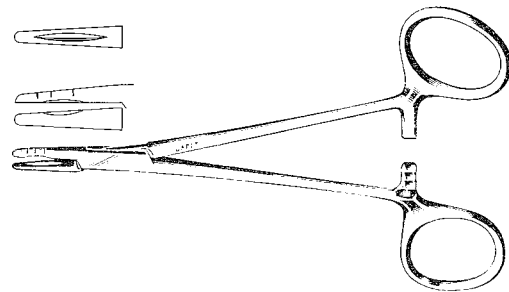

**Derf Needle Holder**

Catalog #	Description
120-100	4 <sup>3</sup> / <sub>4</sub> " (120mm), grooved jaws

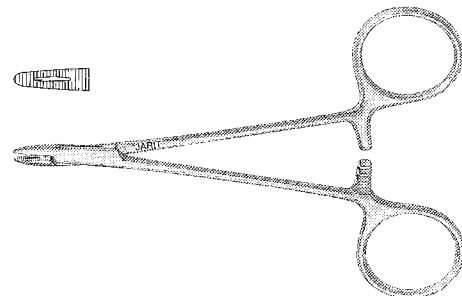

### Baumgartner Needle Holder

Catalog #	Description
120-105	5¼" (133mm), solid jaws

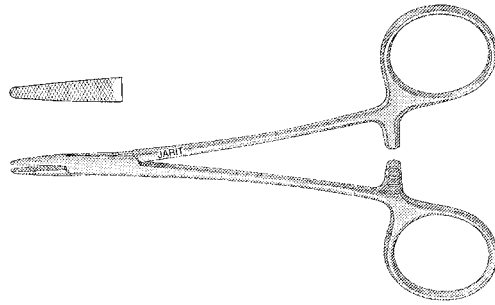

### Baumgartner Needle Holder

Catalog #	Description
120-110	5¼" (133mm), grooved jaws

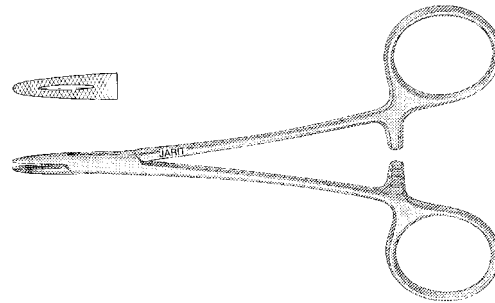

### Hegar-Baumgartner Needle Holder

Catalog #	Description
120-112	5¾" (146mm), grooved jaws

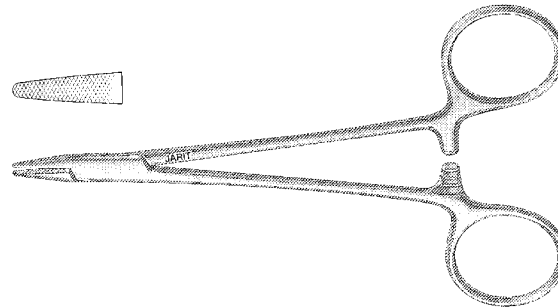

### Collier Needle Holder

Catalog #	Description
120-115	5¾" (135mm), grooved jaws

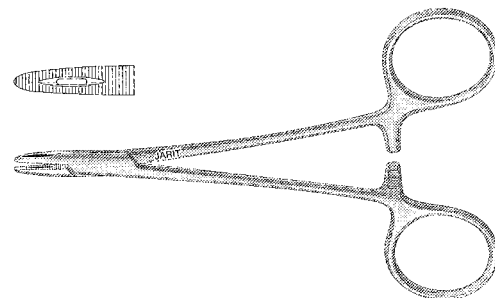

**Webster Needle Holder**

Catalog #	Description
120-118	4½" (115mm), smooth jaws

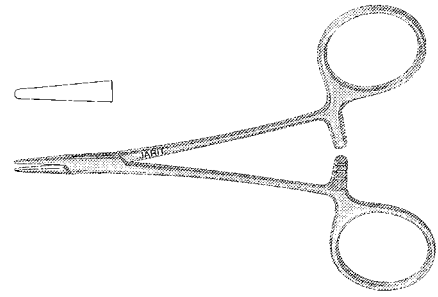

**Halsey Needle Holder**

Catalog #	Description
120-120	5¾" (135mm), smooth jaws

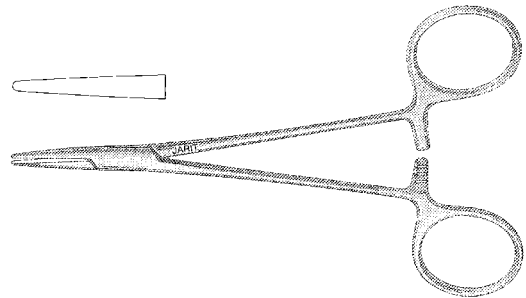

**New Orleans Needle Holder, Grooved Jaw**

Catalog #	Description
120-125	7" (180mm), grooved jaws

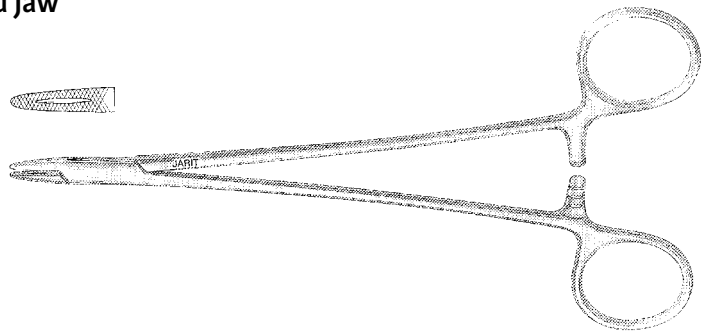

**Crile-Wood Needle Holders, Grooved Jaw**

Catalog #	Description
120-130	6" (152mm)
120-131	7¼" (183mm)
120-132	8" (206mm)

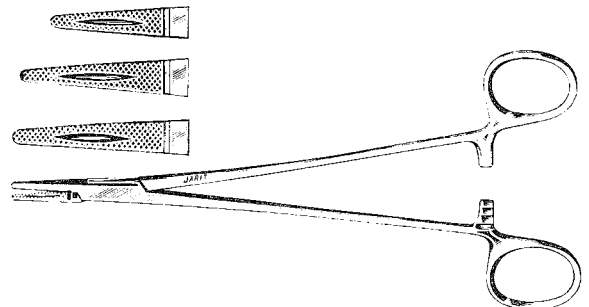

**Mayo-Hegar Needle Holders, Grooved Jaw**

Catalog #	Description
120-135	6¼" (160mm)
120-140	7½" (190mm)
120-145	8" (203mm)
120-147	12" (305mm)

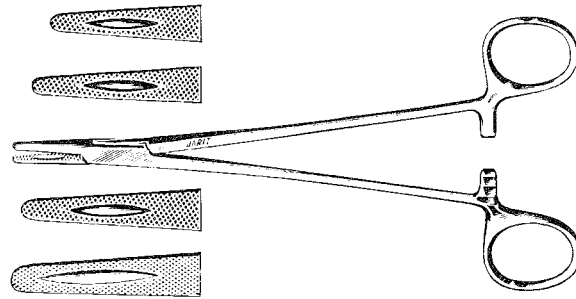

**Petit-Point Olsen-Hegar Needle Holder/Scissors**

Catalog #	Description
120-148	4¾" (120mm), delicate, serrated jaw
120-149	4¾" (120mm), delicate, smooth jaw

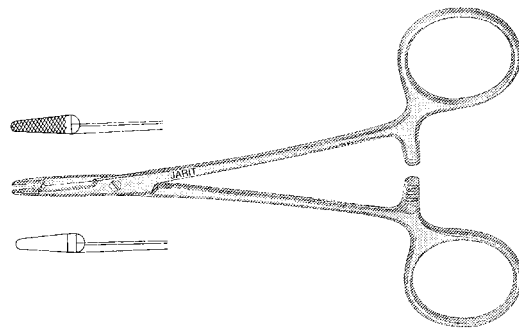

**Olsen-Hegar Needle Holder/Scissors**  
grooved jaw

Catalog #	Description
120-150	5⅜" (138mm)
120-155	6¾" (170mm)

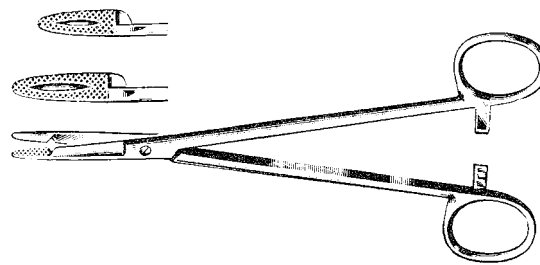

**Masson Needle Holder**

Catalog #	Description
120-180	10½" (268mm), solid jaws

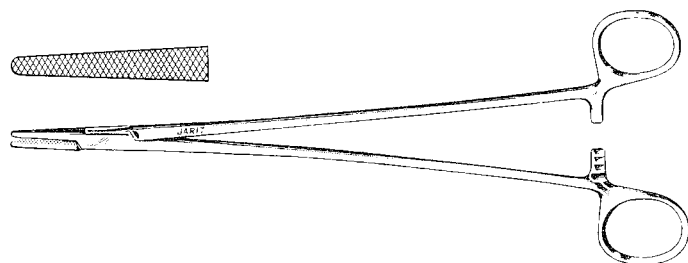

**Sarot Needle Holder, Grooved Jaw**

Catalog #	Description
120-200	7" (180mm), delicate, grooved jaws

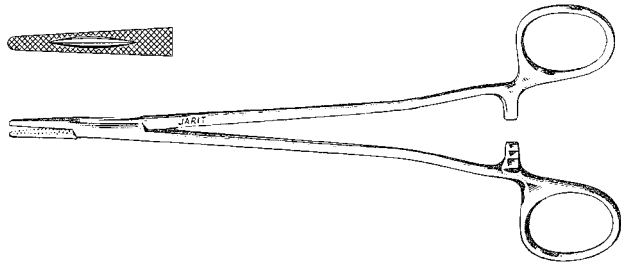

**Heaney Needle Holder**

Catalog #	Description
120-210	8" (205mm), curved, solid jaws

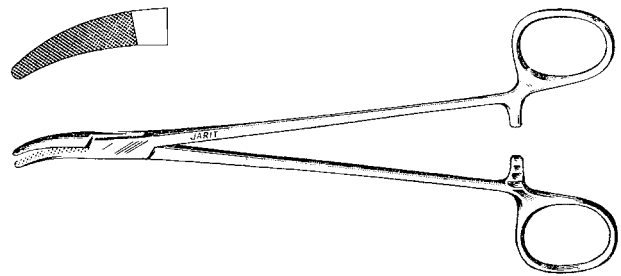

**Bayonet Needle Holder**

Catalog #	Description
120-215	6½" (168mm), rounded fine tapered jaws

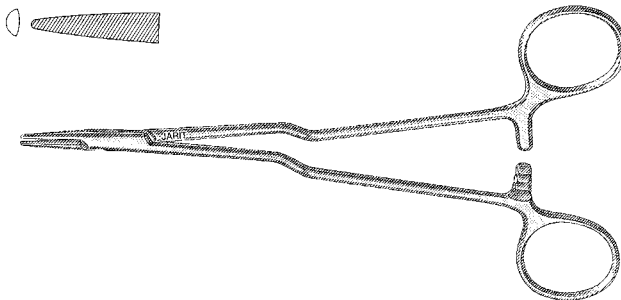

### Carb-Bite™ Needle Holders

Jarit Carb-Bite Needle Holders feature jaw inserts of solid tungsten carbide. Sharply defined serrations have been milled into these inserts to provide a secure hold on the suture needle.

Because tungsten carbide is harder than stainless steel, the useful life of Carb-Bite Needle Holders exceeds that of ordinary needle holders. Jarit Carb-Bite Needle Holders are warranted for a minimum of three years of normal usage. If jaw serrations should wear smooth while under warranty, new Carb-Bite inserts will be installed without charge. Finger rings are gold plated for easy identification.



**Neivert Needle Holder, Carb-Bite**

4000 teeth per square inch, for use with 4.0 and 5.0 suture

Catalog #	Description
121-097	5" (126mm), thumb ring turned up

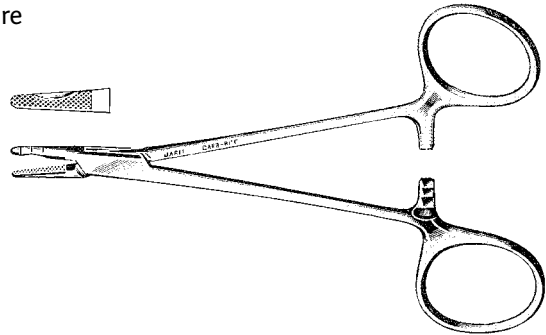

**Derf Needle Holder, Carb-Bite**

4000 teeth per square inch, for use with 4.0, 5.0, 6.0 suture

Catalog #	Description
121-100	4¾" (120mm)

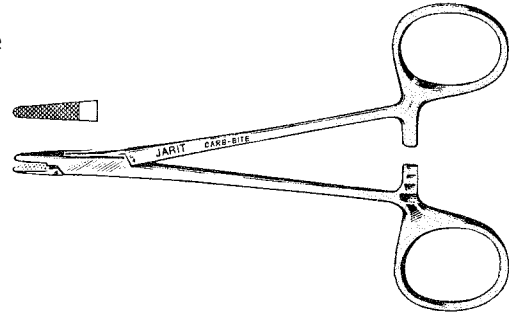

**Baumgartner Needle Holder, Carb-Bite, (Satin Finish)**

4000 teeth per square inch, for use with 2.0, 3.0, 4.0 suture

Manufactured from high grade German surgical stainless steel which is ground and polished to a satin finish

Catalog #	Description
121-105	5¼" (132mm)

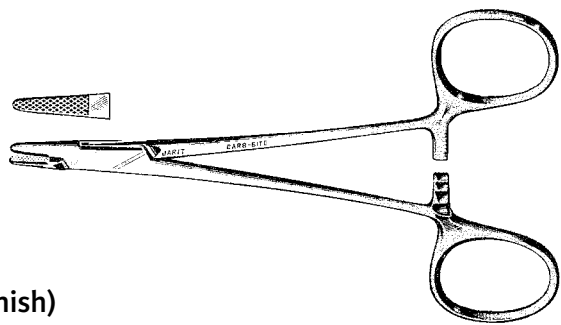

**Baumgartner Needle Holder, Carb-Bite, (Matte Finish)**

4000 teeth per square inch, for use with 2.0, 3.0, 4.0 suture

Manufactured from high grade German surgical stainless steel which is glass beaded to a matte finish

Catalog #	Description
123-105	5¼" (132mm)

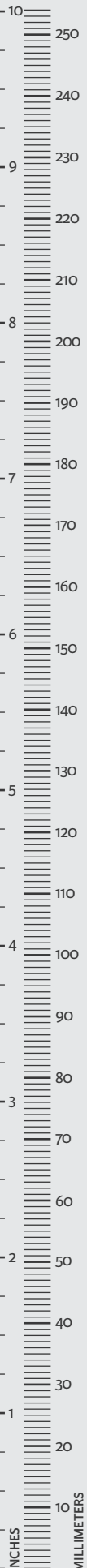
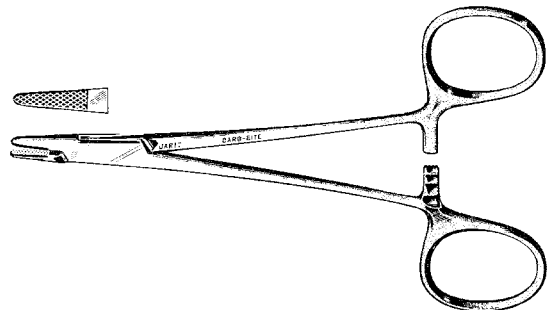



**Hegar-Baumgartnere Needle Holder, Carb-Bite, (Satin Finish)**

2500 teeth per square inch, for use with 2.0, 3.0, 4.0 suture  
Manufactured from high grade German surgical stainless steel which is ground and polished to a satin finish

Catalog #	Description
121-106	5¾" (147mm)

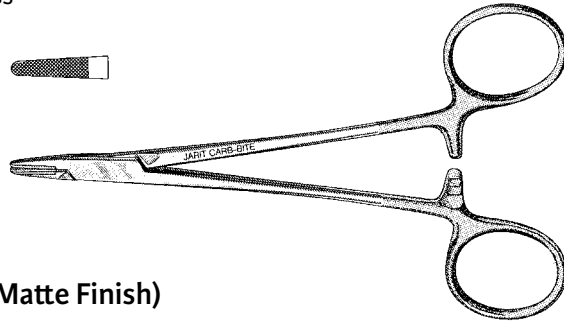

**Hegar-Baumgartner Needle Holder, Carb-Bite, (Matte Finish)**

2500 teeth per square inch, for use with 2.0, 3.0, 4.0 suture  
Manufactured from high grade German surgical stainless steel which is glass beaded to a matte finish

Catalog #	Description
123-106	5¾" (147mm)

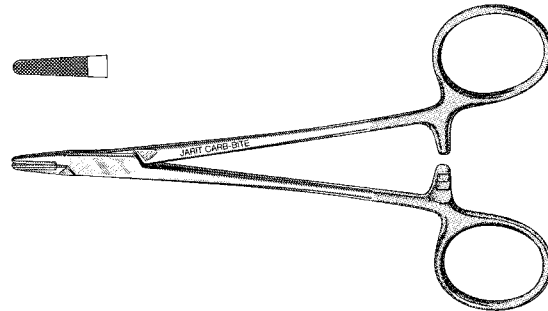

**Par Style Plastic and Recon Needle Holders, Carb-Bite**

7000 teeth per square inch, for use with 6.0, 7.0, 8.0 suture

Catalog #	Description
121-115	4⅝" (117mm), serrated
121-116	4⅝" (117mm), smooth

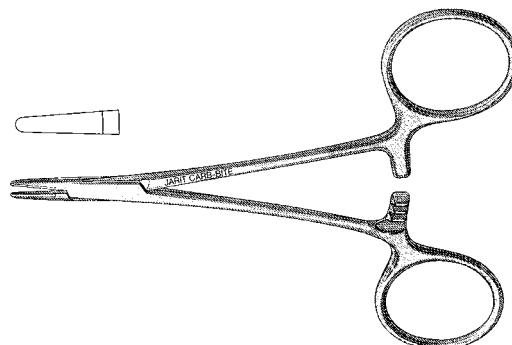
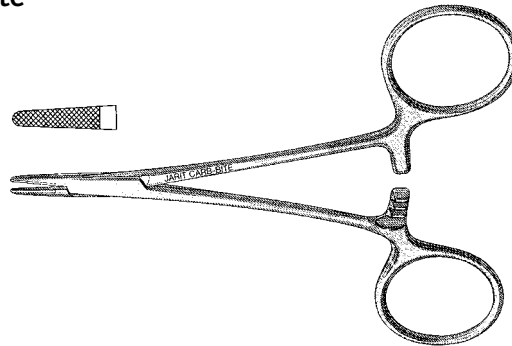

**Webster Needle Holders, Carb-Bite**

3600 teeth per square inch, for use with 5.0 and 6.0 suture

Catalog #	Description
121-119	4 <sup>5</sup> / <sub>8</sub> " (118mm), serrated jaws
121-118	4 <sup>5</sup> / <sub>8</sub> " (118mm), smooth jaws

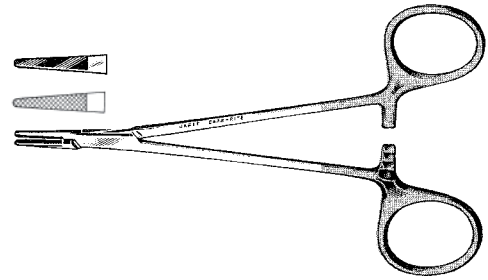

**Halsey Needle Holder, Carb-Bite**

for use with 4.0 and 5.0 suture

Catalog #	Description
121-120	5 <sup>1</sup> / <sub>4</sub> " (133mm), smooth

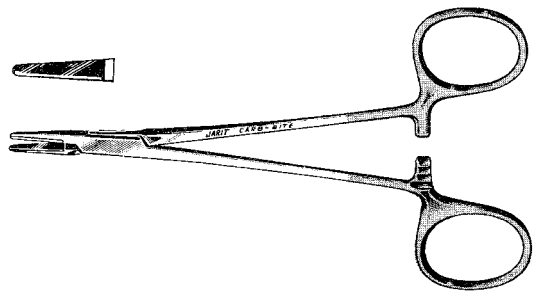

**Halsey Needle Holders, Carb-Bite**

4000 teeth per square inch, for use with 4.0 and 5.0 suture

Catalog #	Description
121-121	5 <sup>1</sup> / <sub>4</sub> " (133mm), serrated

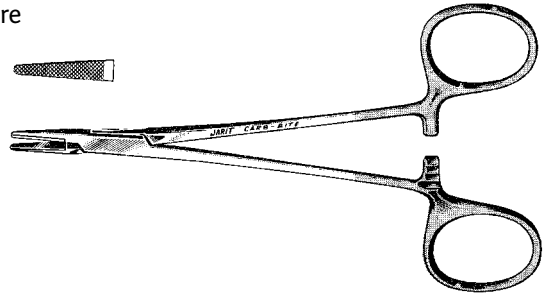

**New Orleans Needle Holders, Carb-Bite**

4000 teeth per square inch, for use with 2.0, 3.0, and 4.0 suture

Catalog #	Description
121-125	7" (180mm)

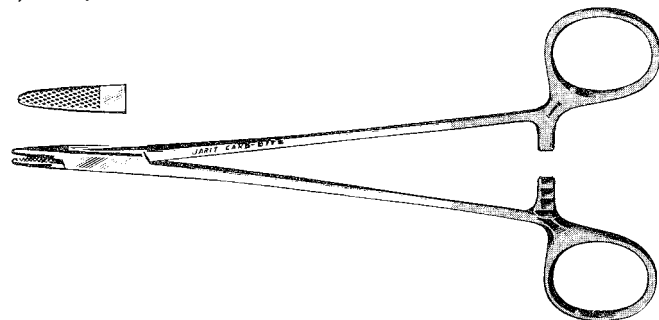

**Crile-Wood Needle Holders, Carb-Bite**

4000 teeth per square inch, for use with 4.0, 5.0 and 6.0 suture curved jaw

Catalog #	Description
121-126	7½" (188mm)
121-127	9¼" (232mm)

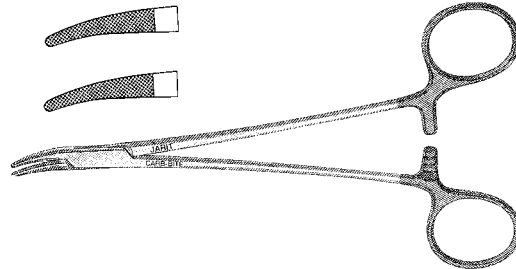

**Crile-Wood Needle Holders, Carb-Bite, (Satin Finish)**

4000 teeth per square inch, for use with 4.0, 5.0 and 6.0 suture  
Manufactured from high grade German surgical stainless steel which is ground and polished to a satin finish

Catalog #	Description
121-130	6" (152mm)
121-131	7" (180mm)
121-132	8" (205mm)
121-133	9" (231mm)
121-134	10½" (267mm)
121-129	12¼" (311mm)
121-128	14" (356mm)

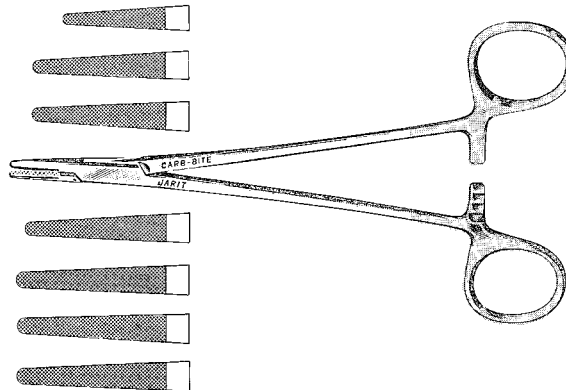

**Crile-Wood Needle Holders, Carb-Bite, (Matte Finish)**

4000 teeth per square inch, for use with 4.0, 5.0 and 6.0 suture  
Manufactured from high grade German surgical stainless steel which is glass beaded to a matte finish

Catalog #	Description
123-130	6" (152mm)
123-131	7" (180mm)
123-132	8" (205mm)

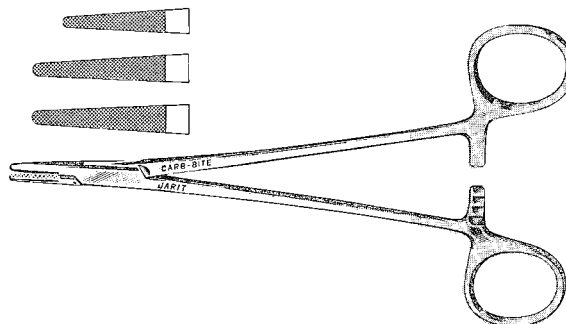

**Mayo-Hegar Needle Holder, Carb-Bite, (Satin Finish)**

2500 teeth per square inch, for use with 1.0, 2.0, 3.0 and 4.0 suture

Manufactured from high grade German surgical stainless steel which is ground and polished to a satin finish

Catalog #	Description
121-135	6 1/4" (160mm)
121-140	7 1/4" (187mm)
121-145	8" (206mm)
121-146	9 1/2" (240mm)
121-142	10 3/8" (263mm)
121-143	11" (280mm)
121-147	11 3/4" (300mm)
121-144	13 3/4" (350mm)

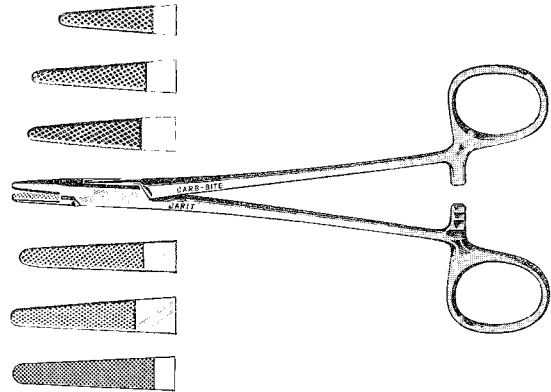

**Mayo-Hegar Needle Holder, Carb-Bite, (Matte Finish)**

2500 teeth per square inch, for use with 1.0, 2.0, 3.0 and 4.0 suture

Manufactured from high grade German surgical stainless steel which is ground and polished to a matte finish

Catalog #	Description
123-135	6 1/4" (160mm)
123-140	7 1/4" (187mm)
123-145	8" (206mm)

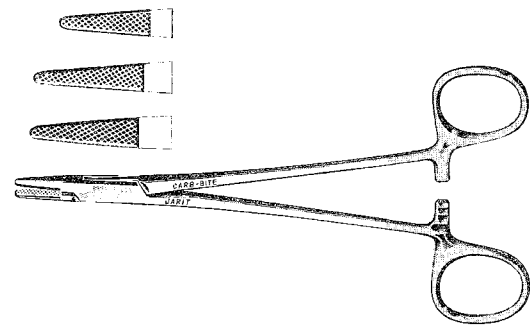

**Fell Needle Holders, Carb-Bite**

4000 teeth per square inch, for use with 2.0, 3.0 and 4.0 suture

2mm tips x 15mm long

Catalog #	Description
121-270	5 1/4" (132mm)
121-271	6 1/4" (159mm)
121-272	7" (178mm)
121-173	8" (203mm)
121-174	9" (227mm)



### Petit-Point Olsen-Hegar Needle Holder/Scissors, Carb-Bite

7000 teeth per square inch, for use with 6.0, 7.0, 8.0 suture

Catalog #	Description
121-148	4¾" (120mm), delicate, serrated
121-149	4¾" (120mm), delicate, smooth

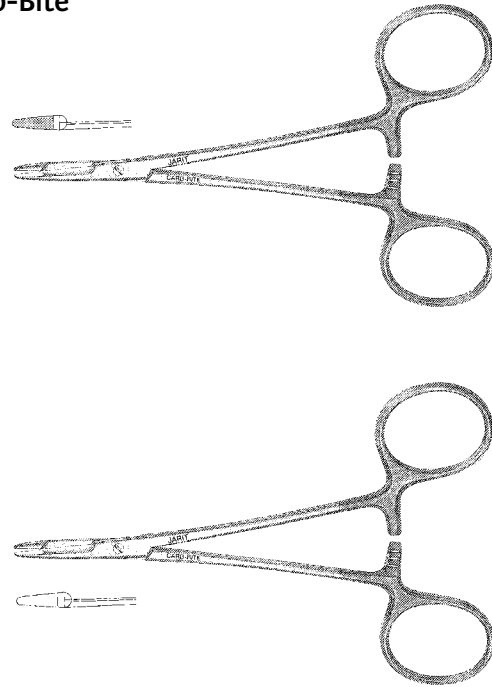

### Olsen-Hegar Needle Holder/Scissors, Carb-Bite

4000 teeth per square inch, for use with 4.0, 5.0, 6.0 suture

Catalog #	Description
121-150	5¾" (147mm), delicate, serrated
121-155	6¼" (161mm), delicate, serrated

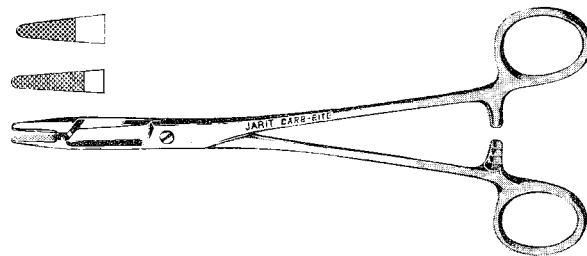

### Ryder Needle Holders, Carb-Bite

4000 teeth per square inch, for use with 4.0, 5.0 and 6.0 suture

Catalog #	Description
121-160	5" (126mm), jaws 1.6mm x 10mm
121-161	5⅞" (149mm), jaws 1.6mm x 10mm
121-162	7¼" (184mm), jaws 1.6mm x 12mm
121-163	8" (202mm), jaws 1.6mm x 12mm
121-164	9" (230mm), jaws 1.6mm x 15mm
121-165	10¼" (262mm), jaws 1.6mm x 15mm

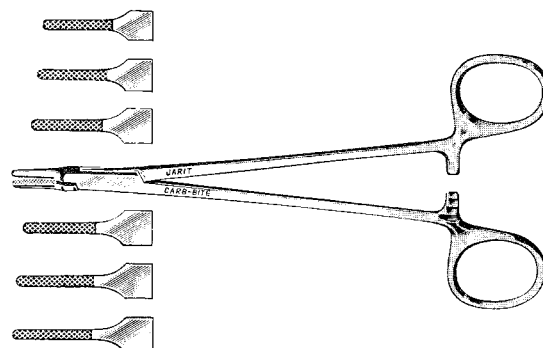

**Hufnagel-Ryder Needle Holder, Carb-Bite**

4000 teeth per square inch, for use with 4.0, 5.0 and 6.0 suture

Catalog #	Description
121-166	8¾" (225mm)

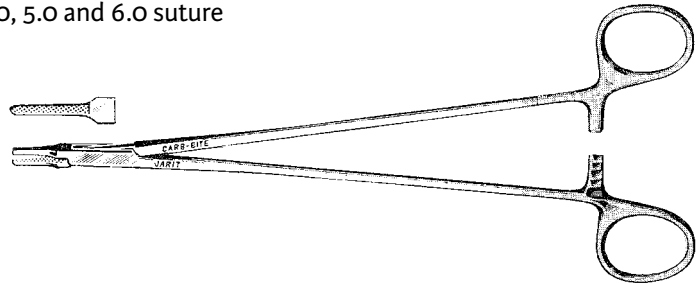

**Petit-Point Ryder Needle Holders, Carb-Bite**

7000 teeth per square inch, for use with 4.0, 5.0 and 6.0 suture  
serrated jaws

Catalog #	Description
121-170	4⅞" (124mm), serrated, jaws 1mm x 9mm
121-172	6¼" (156mm), serrated, jaws 1mm x 9mm
121-174	7" (176mm), serrated, jaws 1mm x 10mm
121-176	7¾" (200mm), serrated, jaws 1mm x 12mm
121-177	9" (228mm), serrated, jaws 1mm x 12mm

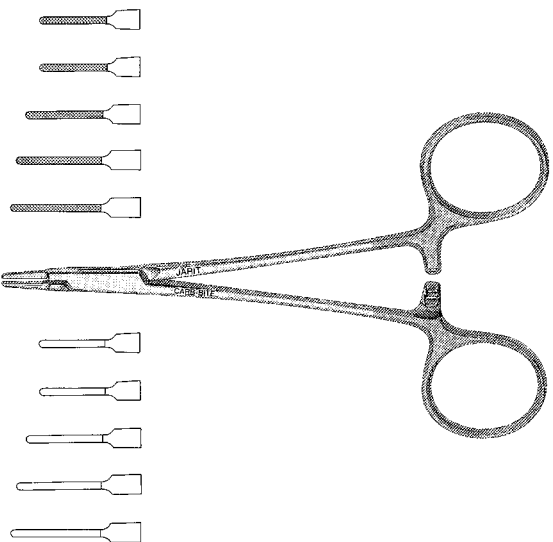

**Petit-Point Ryder Needle Holders, Carb-Bite**

smooth jaws, for use with 4.0, 5.0 and 6.0 suture

Catalog #	Description
121-171	4⅞" (124mm), smooth, jaws 1mm x 9mm
121-173	6¼" (156mm), smooth, jaws 1mm x 9mm
121-175	7" (176mm), smooth, jaws 1mm x 10mm
121-179	8" (203mm), smooth, jaws 1mm x 12mm
121-178	9" (228mm), smooth, jaws 1mm x 12mm

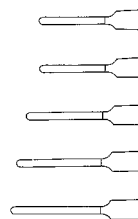

**Masson Needle Holder, Carb-Bite**

2500 teeth per square inch, for use with 1.0, 2.0, 3.0 and 4.0 suture

Catalog #	Description
121-180	10½" (268mm)

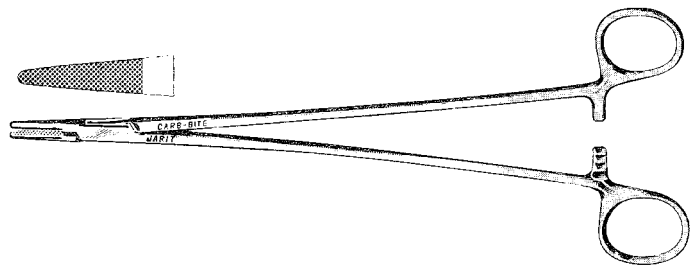

### Diethrich Microvascular Needle Holders, Carb-Bite

7000 teeth per square inch, for use with 6.0 and 7.0 suture

Catalog #	Description
121-181	7" (180mm)
121-182	7¾" (200mm)
121-183	9" (230mm)

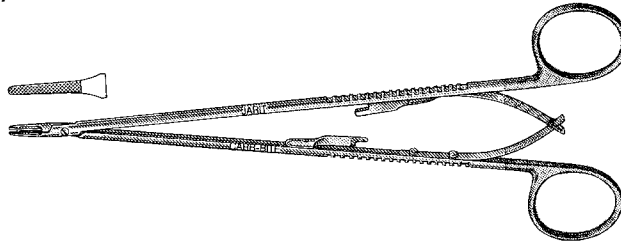

### DeBakey Vascular Needle Holders, Carb-Bite

7000 teeth per square inch, for use with 5.0, 6.0 and 7.0 suture

Catalog #	Description
121-184	5⅞" (150mm)
121-185	7" (178mm)
121-186	8" (205mm)
121-187	9" (230mm)
121-188	10¼" (260mm)
121-189	12¼" (311mm)

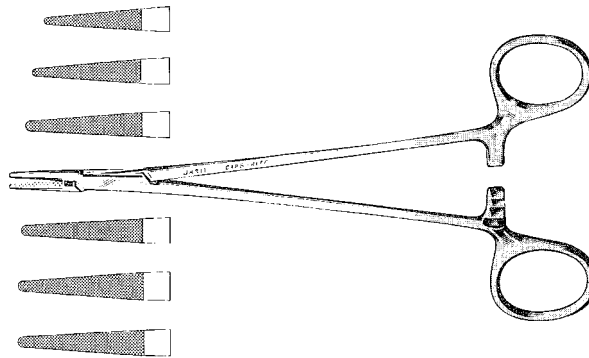

### Finochietto Needle Holder, Carb-Bite

2500 teeth per square inch, for use with 2.0, 3.0 and 4.0 suture

Catalog #	Description
121-192	10¼" (262mm)

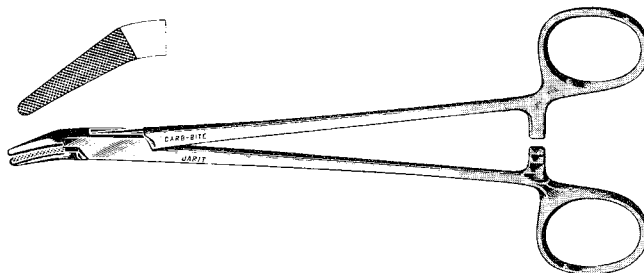

### DeBakey Vascular Needle Holder, Carb-Bite

4000 teeth per square inch, for use with 4.0, 5.0 and 6.0 suture

Catalog #	Description
121-193	9" (230mm), curved

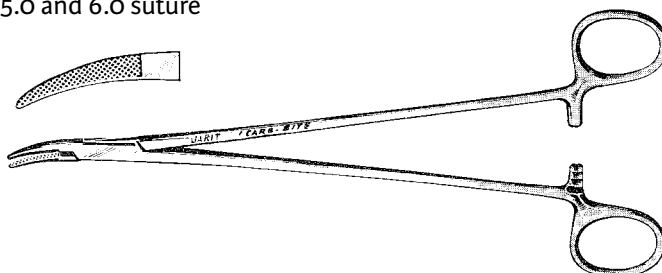

**Stratte Valve Needle Holders, Carb-Bite**

2500 teeth per square inch, for use with 2.0, 3.0 and 4.0 suture

Catalog #	Description
121-195	9" (227mm), double curved
121-196	9¾" (250mm), double curved, delicate

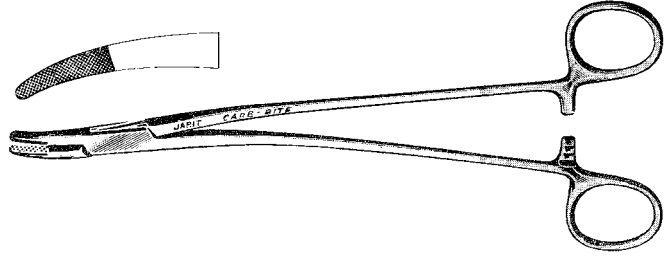

**Petit-Point Sarot Needle Holders, Carb-Bite**

4000 teeth per square inch, for use with 5.0 and 6.0 suture

Catalog #	Description
121-197	5⅞" (150mm), delicate
121-198	6¾" (169mm), delicate

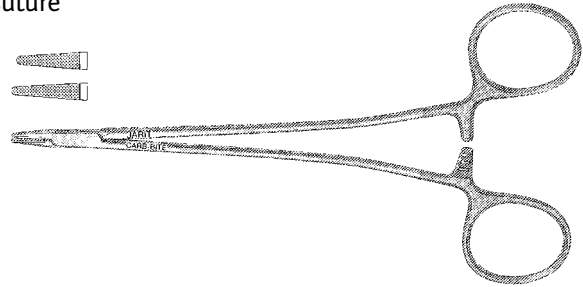

**Sarot Needle Holders, Carb-Bite**

2500 teeth per square inch, for use with 4.0, 5.0 and 6.0 suture

Catalog #	Description
121-200	7¼" (182mm)
121-205	10¼" (258mm)

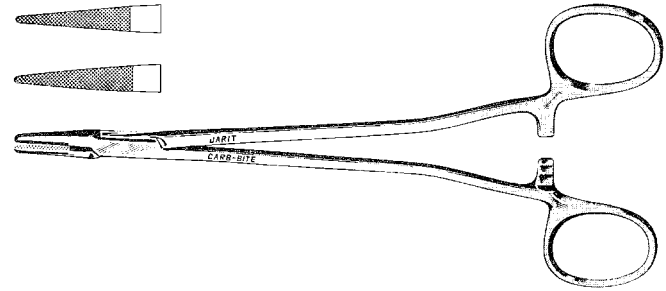

**Julian Needle Holders, Carb-Bite**

4000 teeth per square inch, for use with 4.0, 5.0 and 6.0 suture

Catalog #	Description
121-206	8¼" (210mm), straight
121-207	8¼" (210mm), curved

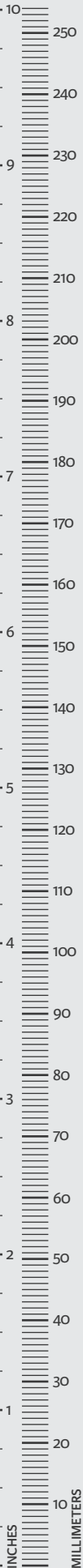
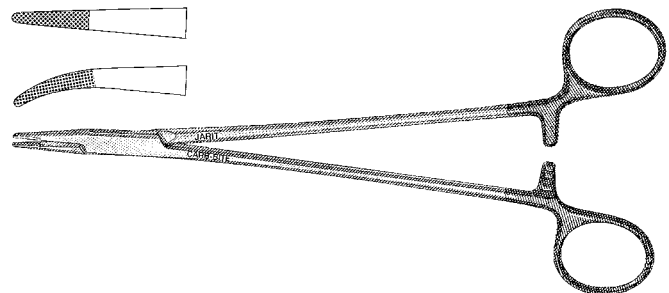



### Heaney Needle Holders, Carb-Bite

2500 teeth per square inch, for use with 2.0, 3.0, 4.0 suture

Catalog #	Description
121-210	8" (206mm), curved
121-209	10½" (267mm), curved
121-204	11¾" (300mm), curved

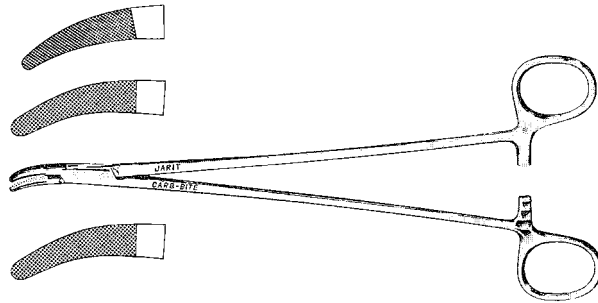

### Microvascular Needle Holders, Carb-Bite

4000 teeth per square inch, for use with 4.0, 5.0, and 6.0 suture, light weight model, slender jaws

Catalog #	Description
121-211	6" (152mm)
121-212	7¼" (184mm)
121-213	8" (203mm)
121-214	9" (228mm)
121-215	10½" (267mm)

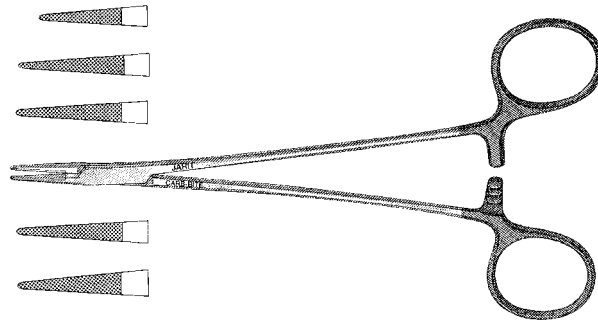

### Cooley Intracardiac Needle Holders, Carb-Bite

4000 teeth per square inch, for use with 2.0, 3.0 and 4.0 suture

Catalog #	Description
121-216	7" (179mm)
121-217	8" (202mm)
121-218	9" (229mm)
121-219	10¼" (261mm)

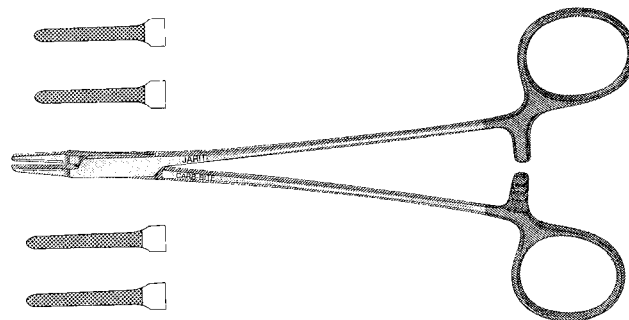

**Mathieu Needle Holders, Carb-Bite**

2500 teeth per square inch, for use with 2.0, 3.0, and 4.0 suture

Catalog #	Description
121-220	8" (203mm)

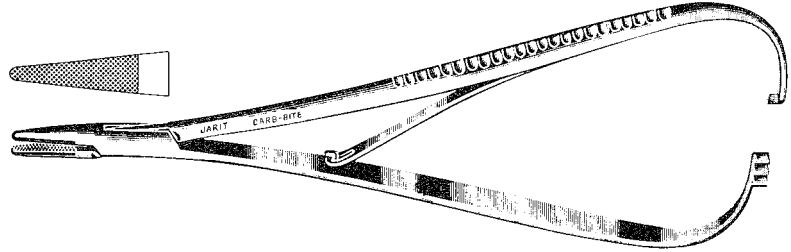

**Castroviejo Style Microsurgical Needle Holders, Carb-Bite**

7000 teeth per square inch, 1mm tips, for use with 5.0, 6.0 and 7.0 suture  
serrated jaws

Catalog #	Description
121-229	7" (178mm)
121-229NL	7" (178mm) (Non Locking)
121-231	8½" (216mm)
121-231NL	8½" (216mm) (Non Locking)

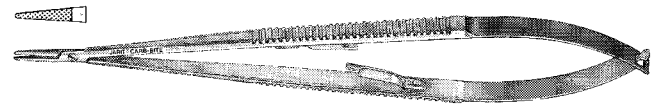

**Castroviejo Style Microsurgical Needle Holders, Carb-Bite**

7000 teeth per square inch, 1mm tips, for use with 5.0, 6.0 and 7.0 suture  
smooth jaws

Catalog #	Description
121-228	7" (178mm)
121-228NL	7" (178mm) (Non Locking)
121-230	8½" (216mm)
121-230NL	8½" (216mm) (Non Locking)

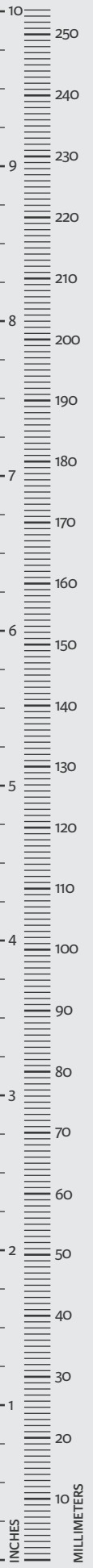

**Rubio Sternal Needle Holder and Wire Twister, Carb-Bite**

4000 teeth per square inch, for use with 1.0 and 2.0 suture

Catalog #	Description
121-250	5 1/4" (132mm)

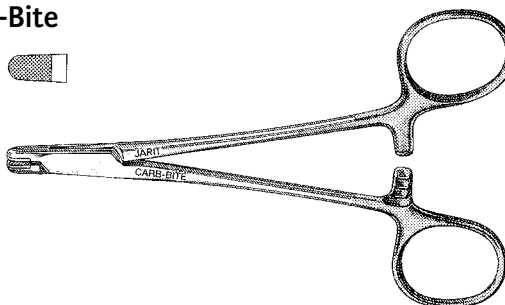

**Sternal Needle Holder and Wire Twister, Carb-Bite**

4000 teeth per square inch, for use with 1.0 and 2.0 suture

Catalog #	Description
121-255	7" (176mm)

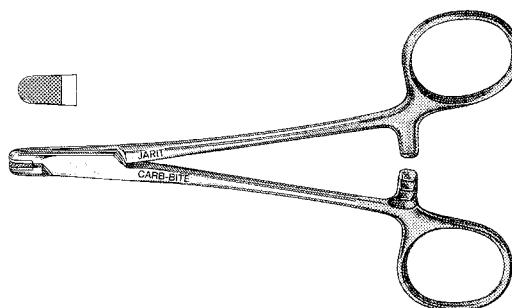

**Wire Twister, Carb-Bite**

2500 teeth per square inch, for use with 1.0 and 2.0 suture

Catalog #	Description
121-257	6" (155mm), short delicate jaws
121-258	6" (155mm), short blunt jaws

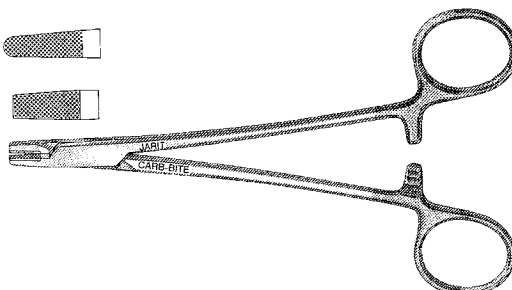

**Berry Sternal Needle Holder and Wire Twister, Carb-Bite**

1800 teeth per square inch, for use with 1.0 and 2.0 suture

Catalog #	Description
121-260	7 1/4" (186mm), heavy duty, 5mm x 17mm jaws

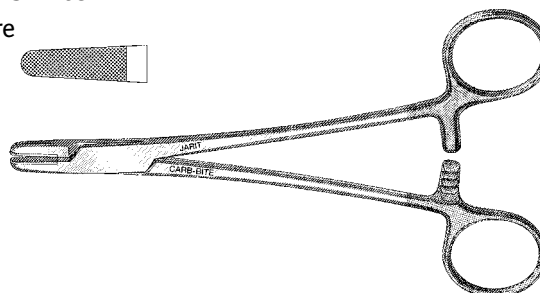

**Cooley-Baumgarten Sternal Wire Twister, Carb-Bite**

2500 teeth per square inch, for use with 1.0 and 2.0 suture

Catalog #	Description
121-265	8" (205mm), heavy duty, blunt jaws, textured tip



### Carb-Bite™ Tissue and Needle Pulling Forceps

These versatile forceps feature tips with solid tungsten carbide inserts. Fine, sharply defined serrations have been ground into these inserts to provide non-slip surfaces for grasping tissue and suture needles. Handles are gold plated for easy identification.

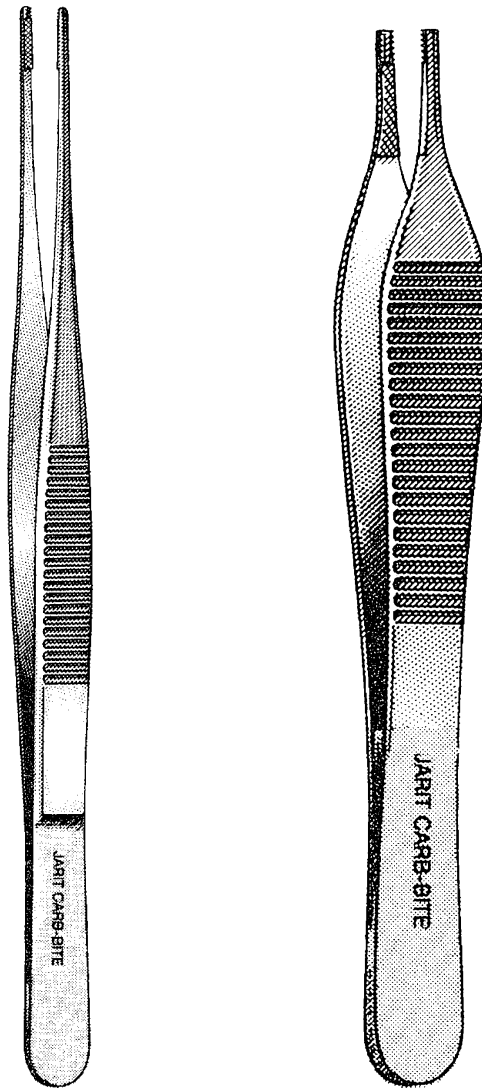

**Adson Needle and Tissue Pulling Forceps, Carb-Bite**

1 x 2 teeth

Catalog #	Description
122-500	4 <sup>7</sup> / <sub>8</sub> " (123mm)
122-501	4 <sup>5</sup> / <sub>8</sub> " (119mm), delicate
122-502	5 <sup>7</sup> / <sub>8</sub> " (150mm)
122-503	5 <sup>7</sup> / <sub>8</sub> " (150mm), delicate

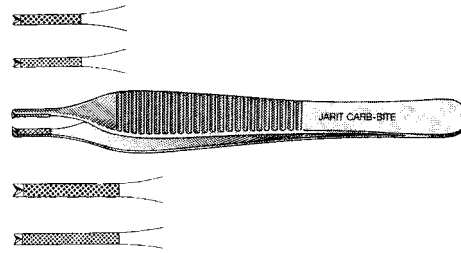

**Brown-Adson Needle and Tissue Pulling Forceps, Carb-Bite**

3 x 4 teeth

Catalog #	Description
122-510	4 <sup>7</sup> / <sub>8</sub> " (124mm)

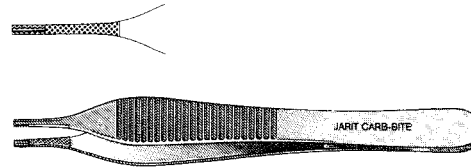

**Bonney Needle and Tissue Pulling Forceps, Carb-Bite**

1 x 2 teeth, 3.4mm x 22.5mm tips

Catalog #	Description
122-520	6 <sup>3</sup> / <sub>4</sub> " (173mm)

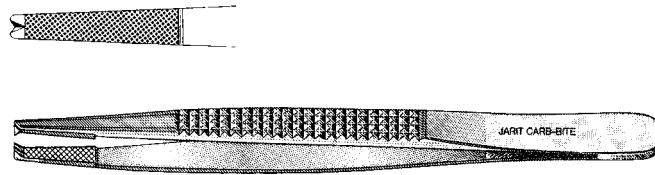

**Cushing Needle and Tissue Pulling Forceps, Carb-Bite**

Gutsch handle, scraper end

Catalog #	Description
122-530	7" (176mm), 1.8mm wide x 12mm length
122-535	7" (176mm), delicate, 1.6mm wide x 8mm length

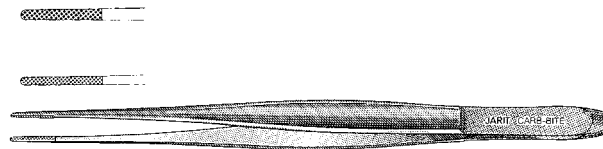

**DeBakey Needle and Tissue Pulling Forceps, Carb-Bite**

3 x 6 teeth, 2.0mm x 8mm tips

Catalog #	Description
122-540	5 <sup>7</sup> / <sub>8</sub> " (150mm)
122-542	7 <sup>3</sup> / <sub>4</sub> " (197mm)
122-544	9 <sup>1</sup> / <sub>2</sub> " (240mm)

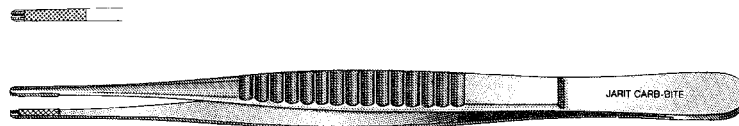

**DeBakey Needle and Tissue Pulling Forceps, Carb-Bite**

3 x 6 teeth, 1.5mm x 8mm tips

Catalog #	Description
122-541	6" (151mm)
122-543	7 <sup>3</sup> / <sub>4</sub> " (197mm)
122-545	9 <sup>1</sup> / <sub>2</sub> " (240mm)

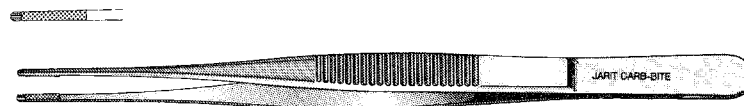

**Ferris-Smith Needle and Tissue Pulling Forceps, Carb-Bite**

1 x 2 teeth, 3mm x 12.5mm tips

Catalog #	Description
122-550	6¾" (174mm)

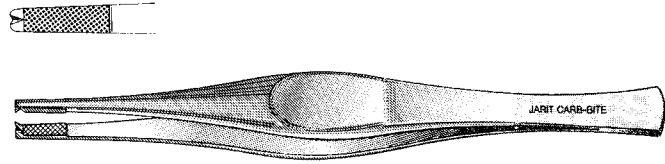

**General Needle and Tissue Pulling Forceps, Carb-Bite**

1 x 2 teeth, 3mm x 12mm tips

Catalog #	Description
122-560	6" (155mm)

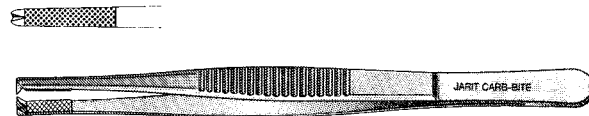

**Gerald Needle and Tissue Pulling Forceps, Carb-Bite**

1 x 2 teeth, 1.2mm x 12mm tips

Catalog #	Description
122-570	7" (176mm), delicate

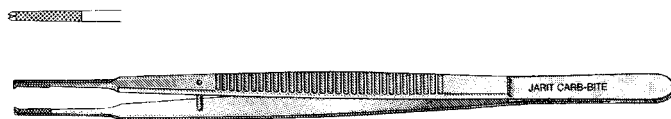

**Semken Needle and Tissue Pulling Forceps, Carb-Bite**

1 x 2 teeth

Catalog #	Description
122-590	6" (153mm), 1.7mm x 12mm tips
122-591	6" (153mm), 1mm x 12mm tips, delicate

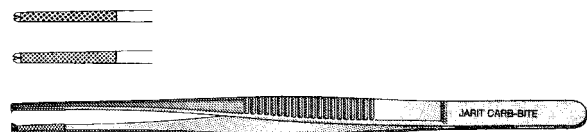

**Skinner Needle and Tissue Pulling Forceps, Carb-Bite**

1 x 2 teeth

Catalog #	Description
122-600	9¼" (232mm), 4.5mm x 8mm tips
122-601	9¼" (232mm), 2.6mm x 8mm tips, delicate
122-602	9¼" (232mm), 2mm x 8mm tips, micro

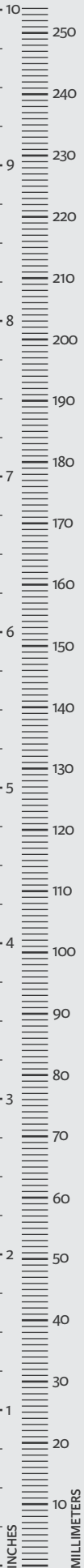
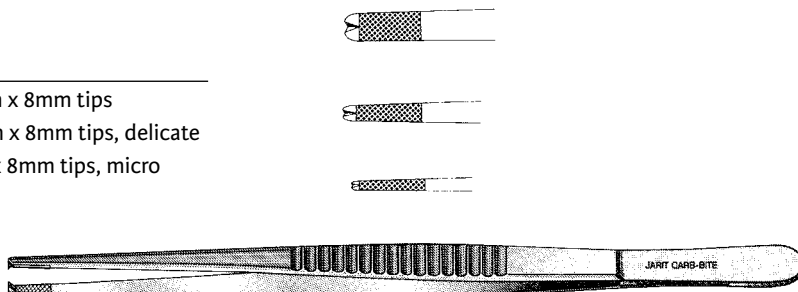

**Hegenbarth Clip Applying Forceps**

Catalog #	Description
125-100	5" (127mm)

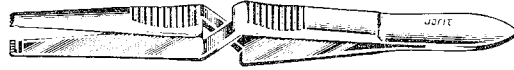

**Michel Clip Applying/Removing Forceps**

Catalog #	Description
125-110	4 <sup>7</sup> / <sub>8</sub> " (124mm), double ended

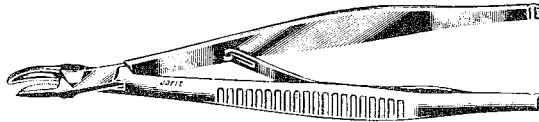

**Michel Skin Clips, package of 1000**

Catalog #	Description
125-114	7.5mm
125-115	11mm
125-117	14mm
125-120	16mm
125-122	18mm

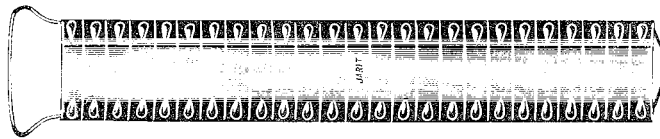

**Richter-Heath Clip Forceps**

Catalog #	Description
125-125	5 <sup>1</sup> / <sub>4</sub> " (134mm), double ended

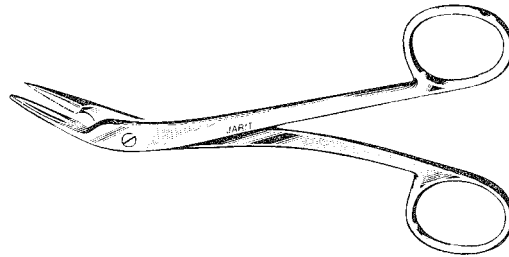

**Wachtenfeld Clip Forceps**

Catalog #	Description
125-130	5" (127mm)



**Wachtenfeld Clip Forceps**

Catalog #	Description
125-132	4 <sup>3</sup> / <sub>4</sub> " (121mm), cross-action

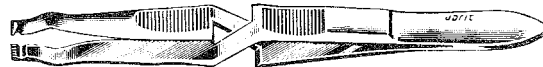

**Deschamps Ligature Carriers**

Catalog #	Description
125-150	8" (203mm), sharp, left
125-152	8" (203mm), sharp, right
125-154	8" (203mm), blunt, left
125-155	8" (203mm), blunt, right

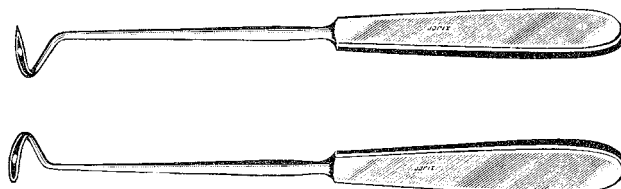

**New's Suture Scissors**

Catalog #	Description
125-165	5 <sup>5</sup> / <sub>8</sub> " (142mm), angled on flat

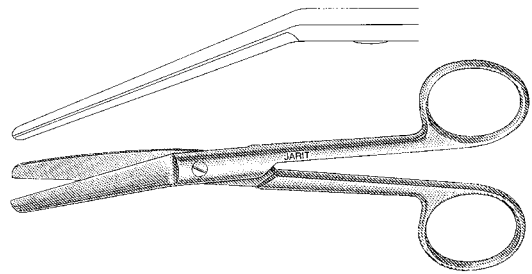

**Universal Wire Suture Scissors**

Catalog #	Description
125-170	4 <sup>3</sup> / <sub>4</sub> " (122mm), angled, one serrated blade

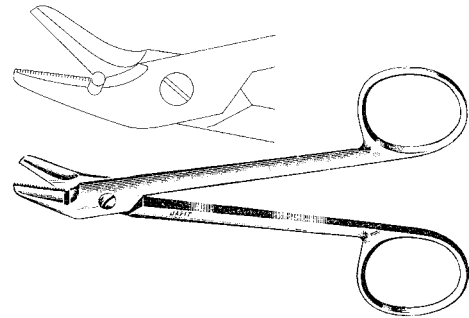

**Universal Wire Suture Scissors, Carb-Bite**  
for cutting suture and wire (26 gauge and smaller)

Catalog #	Description
101-350	4 <sup>7</sup> / <sub>8</sub> " (124mm), angled, for cutting suture and wire (26 gauge and smaller)

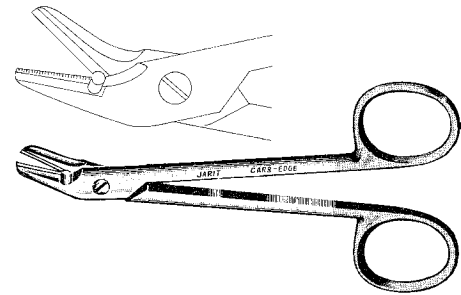

**Heath Suture Scissors**

Catalog #	Description
125-175	6" (155mm), serrated

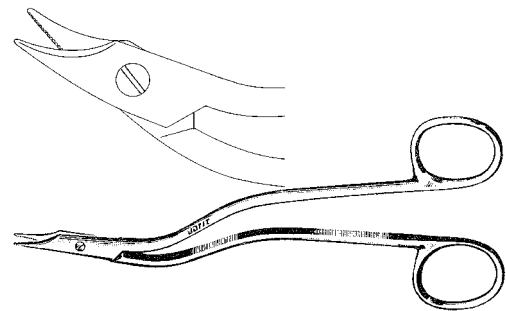

**Spencer Suture Scissors**

Catalog #	Description
125-180	3 <sup>1</sup> / <sub>2</sub> " (90mm)
125-182	5" (127mm)

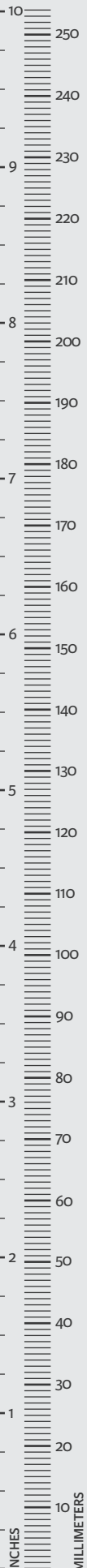
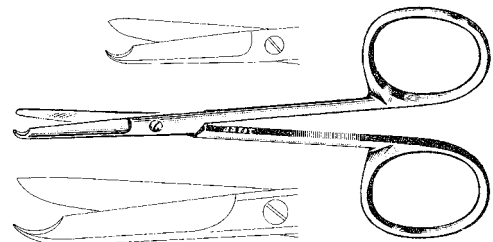



**Spencer Suture Scissors**

curved sideways

Catalog #	Description
125-184	3½" (90mm)
125-185	4¾" (121mm)

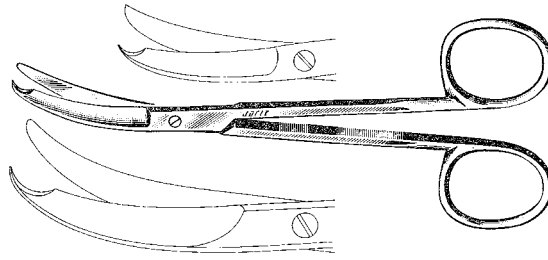

**Littauer Stitch Scissors**

Catalog #	Description
125-190	5½" (140mm)

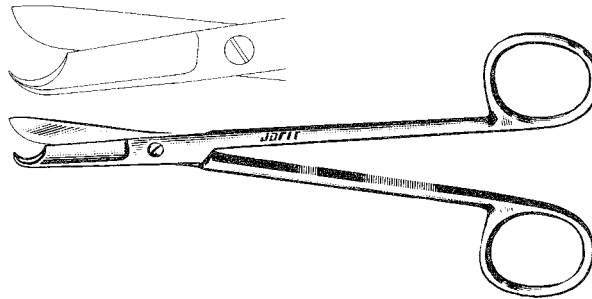

**Suture Wire Scissors**

serrated

Catalog #	Description
125-192	4⅛" (104mm), Straight
125-193	4⅛" (104mm), Curved

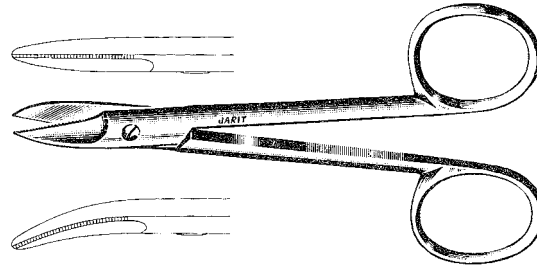

**Smith Wire Scissors**

Catalog #	Description
125-194	6¾" (171mm)

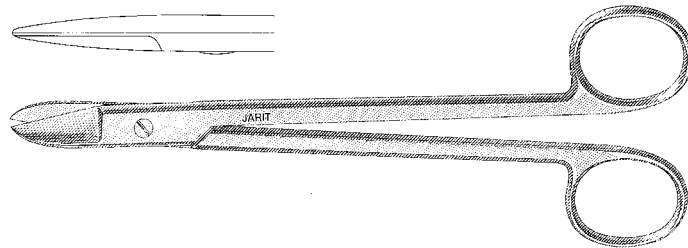

**O'Brien Suture Scissors**

Catalog #	Description
125-195	3⅞" (100mm), angled

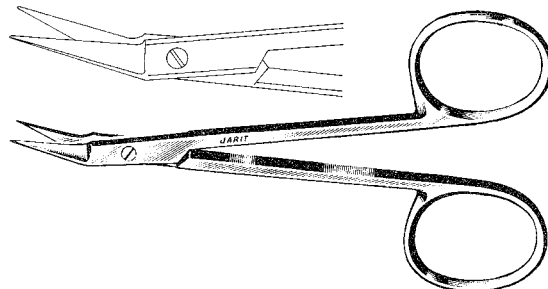

**Dressing Forceps, Serrated, (Matte Finish)**

Manufactured from high grade German surgical stainless steel which is glass beaded to a matte finish

Catalog #	Description
130-099	4 1/8" (105mm)
130-100	4 5/8" (118mm)
130-101	4 5/8" (118mm), fluted handles
130-105	5 1/8" (130mm)
130-110	5 5/8" (142mm)
130-111	5 5/8" (142mm), fluted handles
130-115	6" (154mm)
130-116	6" (154mm), fluted handles
130-117	7 1/4" (184mm)
130-120	7 3/4" (200mm)
130-125	10" (252mm)
130-130	11 3/4" (300mm)
130-132	14" (355mm)



**Dressing Forceps, Serrated, (Mirror Finish)**

Manufactured from high grade German surgical stainless steel which is ground and polished to a mirror finish

Catalog #	Description
129-110	5 5/8" (142mm)
129-115	6" (154mm)



**Tissue Forceps, Carb-Bite**

Catalog #	Description
130-145	6" (152mm)

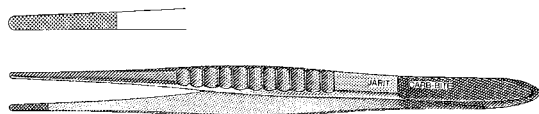

**Tissue Forceps**

1 x 2 teeth, cross serrated

Catalog #	Description
130-185	6" (154mm)

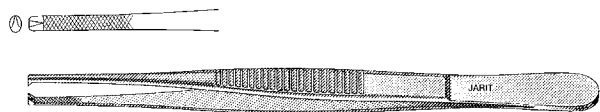

**Tissue Forceps, 1 x 2 teeth, (Matte Finish)**

Manufactured from high grade German surgical stainless steel which is glass beaded to a matte finish

Catalog #	Description
130-150	4 <sup>5</sup> / <sub>8</sub> " (118mm)
130-151	4 <sup>5</sup> / <sub>8</sub> " (118mm), fluted handles
130-155	5 <sup>1</sup> / <sub>8</sub> " (130mm)
130-160	5 <sup>5</sup> / <sub>8</sub> " (144mm)
130-161	5 <sup>5</sup> / <sub>8</sub> " (142mm), fluted handles
130-165	6" (154mm)
130-166	6" (154mm), fluted handles
130-167	7" (180mm)
130-170	8" (204mm)
130-175	9 <sup>3</sup> / <sub>4</sub> " (248mm)
130-180	12" (303mm)
130-182	14" (355mm)



**Tissue Forceps, 1 x 2 teeth, (Mirror Finish)**

Manufactured from high grade German surgical stainless steel which is ground and polished to a mirror finish

Catalog #	Description
129-160	5 <sup>5</sup> / <sub>8</sub> " (142mm)
129-165	6" (154mm)



**Tissue Forceps**

Catalog #	Description
130-200	5 <sup>5</sup> / <sub>8</sub> " (144mm), 2 x 3 teeth
130-201	6" (154mm), 2 x 3 teeth
130-210	5 <sup>5</sup> / <sub>8</sub> " (144mm), 3 x 4 teeth
130-211	6" (154mm), 3 x 4 teeth
130-216	5 <sup>1</sup> / <sub>2</sub> " (140mm), 4 x 5 teeth
130-217	6 <sup>1</sup> / <sub>4</sub> " (158mm), 4 x 5 teeth

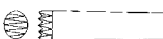
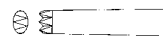

**Von Graefe Tissue Forceps**

Catalog #	Description
130-220	4 <sup>3</sup> / <sub>8</sub> " (112mm)



**College Pliers #317**

Catalog #	Description
130-225	5 <sup>7</sup> / <sub>8</sub> " (150mm), serrated

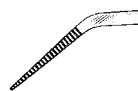

**DeBakey-Diethrich Vascular Tissue Forceps**

straight, extra delicate, 1mm tips

Catalog #	Description
320-050	6" (152mm), 20mm length serrated tips
320-051	7¾" (197mm), 20mm length serrated tips
320-052	9½" (241mm), 20mm length serrated tips



**DeBakey -Diethrich Vascular Tissue Forceps**

straight, delicate, 1.5mm tips

Catalog #	Description
320-113	5⅞" (150mm), 24mm length serrated tips
320-114	7¾" (195mm), 24mm length serrated tips
320-115	9½" (240mm), 24mm length serrated tips
320-099	11¾" (300mm), 24mm length serrated tips

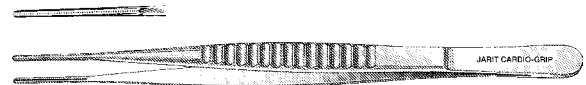

**DeBakey Vascular Tissue Forceps**

straight, standard, 2mm tips

Catalog #	Description
320-110	5⅞" (150mm), 24mm length serrated tips
320-111	7¾" (195mm), 24mm length serrated tips
320-112	9½" (240mm), 24mm length serrated tips
320-109	11¾" (300mm), 24mm length serrated tips
320-108	14¼" (360mm), 24mm length serrated tips

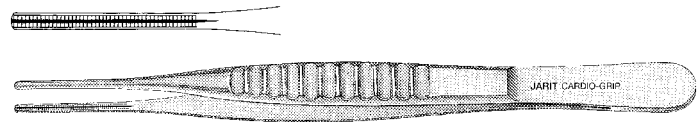

**DeBakey Vascular Tissue Forceps**

angled, standard, 2mm tips

Catalog #	Description
320-105	5⅞" (148mm), 21.5mm length serrated tips
320-106	7½" (192mm), 21.5mm length serrated tips
320-107	9¼" (237mm), 21.5mm length serrated tips

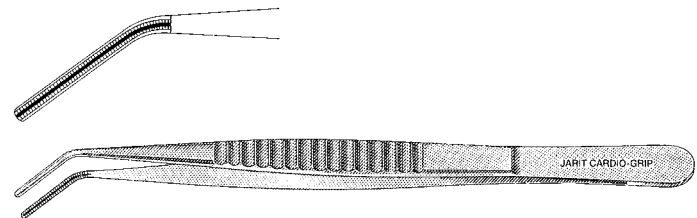

### DeBakey Thoracic Tissue Forceps

straight, heavy, 2.8mm tips

Catalog #	Description
320-100	5 <sup>7</sup> / <sub>8</sub> " (150mm), 24mm length serrated tips
320-101	7 <sup>3</sup> / <sub>4</sub> " (195mm), 24mm length serrated tips
320-102	9 <sup>1</sup> / <sub>2</sub> " (240mm), 24mm length serrated tips
320-103	11 <sup>3</sup> / <sub>4</sub> " (300mm), 24mm length serrated tips
320-104	14 <sup>1</sup> / <sub>4</sub> " (360mm), 24mm length serrated tips

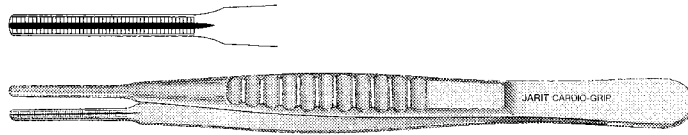

### DeBakey Thoracic Tissue Forceps

straight, extra heavy, 3.5mm tips

Catalog #	Description
320-070	5 <sup>7</sup> / <sub>8</sub> " (150mm), 24mm length serrated tips
320-071	7 <sup>3</sup> / <sub>4</sub> " (195mm), 24mm length serrated tips
320-072	9 <sup>1</sup> / <sub>2</sub> " (240mm), 24mm length serrated tips
320-073	11 <sup>3</sup> / <sub>4</sub> " (300mm), 24mm length serrated tips
320-074	14 <sup>1</sup> / <sub>4</sub> " (360mm), 24mm length serrated tips

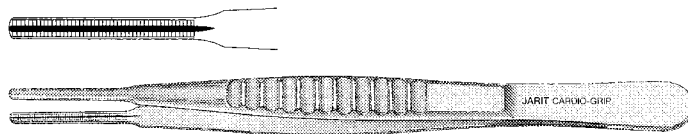

### Cooley Vascular Tissue Forceps

straight, standard, 2mm tips

Catalog #	Description
320-116	5 <sup>7</sup> / <sub>8</sub> " (150mm), 24mm length serrated tips
320-117	7 <sup>3</sup> / <sub>4</sub> " (195mm), 24mm length serrated tips
320-118	9 <sup>1</sup> / <sub>2</sub> " (240mm), 24mm length serrated tips

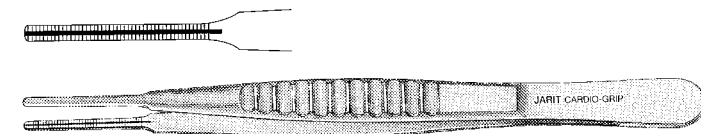

### Cooley Vascular Tissue Forceps

straight, delicate, 1.2mm cross-serrated tips

Catalog #	Description
320-119	7 <sup>7</sup> / <sub>8</sub> " (200mm), 1.2mm wide x 18mm length serrated tips

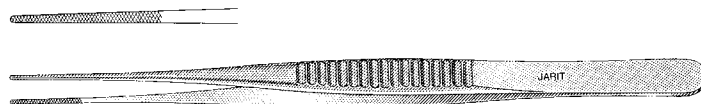

**Adson Dressing Forceps, Serrated, (Matte Finish)**

Manufactured from high grade German surgical stainless steel which is glass beaded to a matte finish

Catalog #	Description
130-230	4¾" (120mm)
130-231	4¾" (120mm), extra delicate, 0.8mm wide tip

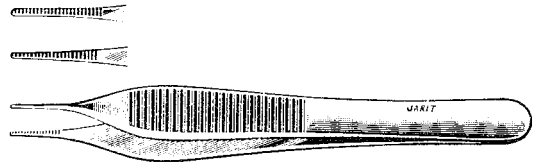

**Adson Dressing Forceps, Serrated, (Mirror Finish)**

Manufactured from high grade German surgical stainless steel which is ground and polished to a mirror finish

Catalog #	Description
129-230	4¾" (120mm)

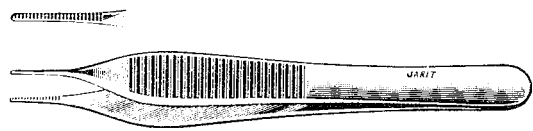

**Adson Dressing Forceps, (Satin Finish)**

Catalog #	Description
130-232	4¾" (120mm), cross serrated

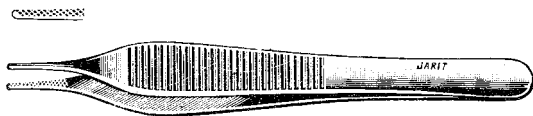

**Adson Tissue Forceps, 1 x 2 teeth, (Mirror Finish)**

Manufactured from high grade German surgical stainless steel which is ground and polished to a mirror finish

Catalog #	Description
130-234	4¾" (120mm)
130-235	4¾" (120mm), extra delicate, 0.8mm wide tip
130-237	4⅝" (117mm), angled jaw
130-238	4¾" (120mm), with tying platform

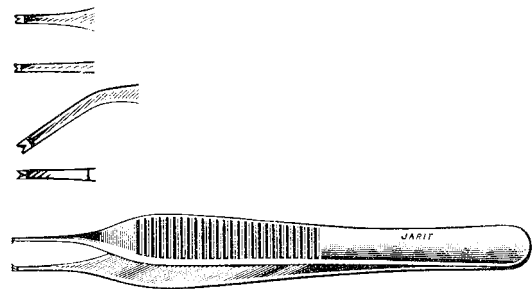

**Adson Tissue Forceps, 1 x 2 teeth, (Satin Finish)**

Manufactured from high grade German surgical stainless steel which is ground and polished to a satin finish

Catalog #	Description
129-234	4¾" (120mm)

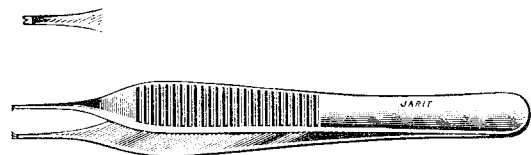

**Adson Tissue Forceps, Carb-Bite, (Mirror Finish)**

Catalog #	Description
130-236	4¾" (120mm)

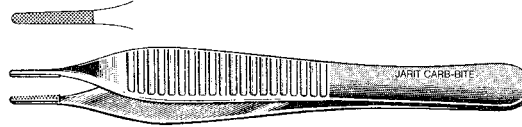

**Adson Tissue Forceps, (Satin Finish)**

Catalog #	Description
130-240	4¾" (120mm), 2 x 3 teeth

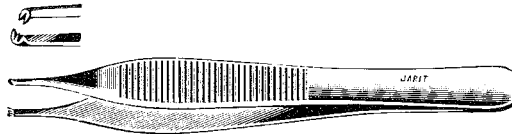

**Adson Dressing Forceps, (Satin Finish)**

Catalog #	Description
130-243	4¾" (120mm), serrated, cross serrated handle

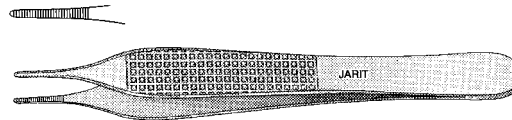

**Adson Tissue Forceps, (Satin Finish)**

Catalog #	Description
130-244	4¾" (120mm), 1 x 2 teeth, cross serrated handle

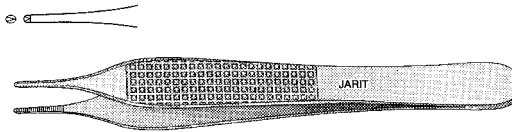

**Adson Tissue Forceps, (Matte Finish)**

Manufactured from high grade German surgical stainless steel which is glass beaded to a matte finish

Catalog #	Description
130-245	4¾" (120mm), 1 x 2 teeth, serrated

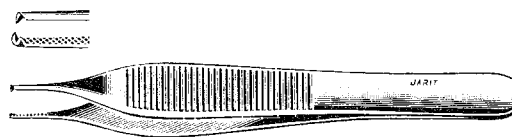

**Adson Tissue Forceps, (Satin Finish)**

delicate

Catalog #	Description
130-241	7" (180mm), 2 x 3 teeth, 3mm wide tip

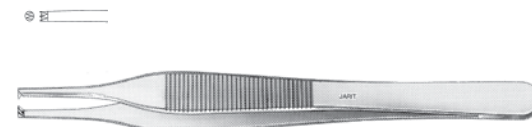

**Broli-Adson Forceps**

6" (152mm), 1.2mm tips

Catalog #	Description
130-246	Straight, serrated tips
130-247	Curved, serrated tips
130-248	Straight, Stardust tips
130-249	Straight, 1 x 2 teeth



**Ewald (Hudson) Dressing Forceps**

Catalog #	Description
130-250	4 7/8" (124mm), serrated

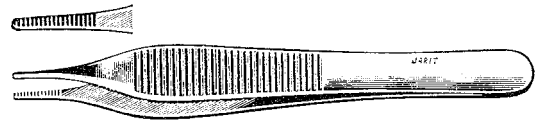

**Ewald (Hudson) Dressing Forceps**

Catalog #	Description
130-255	4 7/8" (124mm), 1 x 2 teeth

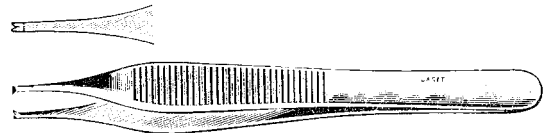

**Brown-Adson Tissue Forceps, 9 x 9 teeth, (Satin Finish)**

Manufactured from high grade German surgical stainless steel which is ground and polished to a satin finish

Catalog #	Description
130-260	4 7/8" (124mm)



**Brown-Adson Tissue Forceps, 9 x 9 teeth, (Mirror Finish)**

Manufactured from high grade German surgical stainless steel which is ground and polished to a mirror finish

Catalog #	Description
129-260	4 7/8" (124mm)





**Brown-Adson Tissue Forceps, (Satin Finish)**

9 x 9 teeth, angled

Catalog #	Description
130-270	4 7/8" (124mm)

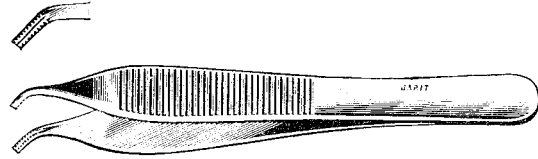

**Beasley-Babcock Tissue Forceps**

6 x 7 teeth

Catalog #	Description
130-262	4 7/8" (124mm)

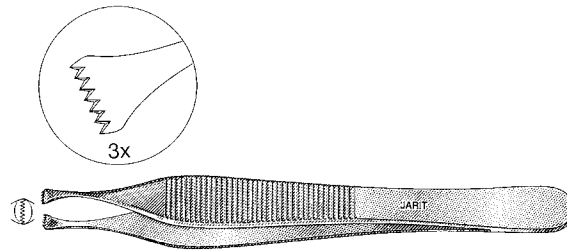

**Brown Tissue Forceps**

8 x 8 teeth

Catalog #	Description
130-265	6" (151mm)
130-266	8" (202mm)
130-267	10" (251mm)



**Semken Dressing Forceps**

Catalog #	Description
130-275	5" (126mm)
130-276	6" (152mm)



### Semken Tissue Forceps

Catalog #	Description
130-280	5" (126mm), 1 x 2 teeth
130-281	6" (154mm), 1 x 2 teeth
130-282	5" (126mm), 2 x 3 teeth

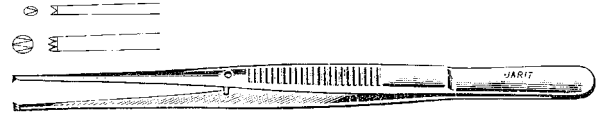

### McIndoe Dressing Forceps

Catalog #	Description
130-284	6" (153mm), serrated jaws, 1.4mm wide x 14mm length

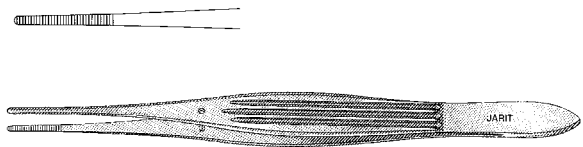

### Gillies Tissue Forceps

Catalog #	Description
130-286	6" (152mm), 1 x 2 cross serrated jaws, 1.6mm wide x 17.5mm length

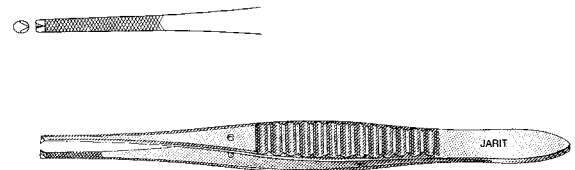

### Brigham Tissue Forceps

Catalog #	Description
130-287	5 5/8" (144mm), 1 x 2 teeth, dissecting end, tip width 2.2mm

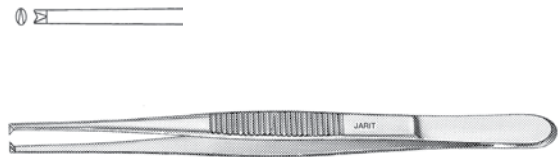

### Ferris-Smith Tissue Forceps

Catalog #	Description
130-289	6 3/4" (174mm), 1 x 2 teeth, 3.9mm wide x 14mm length tips
130-290	6 3/4" (174mm), 2 x 3 teeth, 3.9mm wide x 14mm length tips

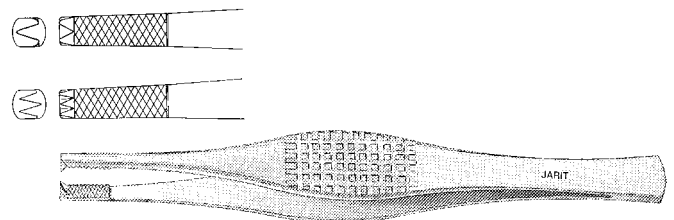

### Bonney Tissue Forceps

3.4mm wide x 26mm length serrated jaws

Catalog #	Description
130-293	6¾" (173mm), 1 x 2 teeth
130-294	6¾" (173mm), 2 x 3 teeth

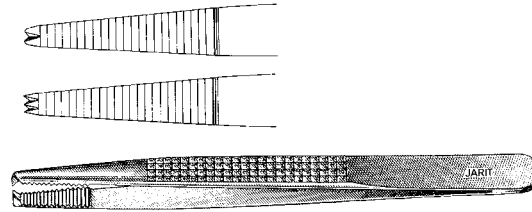

### Wheeler-Type Plaque and Vessel Forceps, Cardio-Grip

1.6mm wide x 6mm length, serrated jaws

Catalog #	Description
130-296	5⅝" (144mm)
130-297	7¼" (182mm)
130-298	9" (226mm)

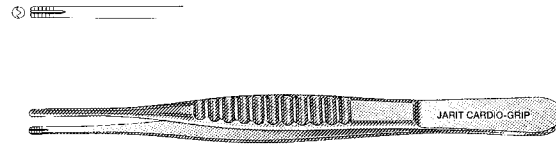

### Alderkreutz Tissue Forceps

4.6mm x 12mm length jaws

Catalog #	Description
130-300	5¾" (145mm)

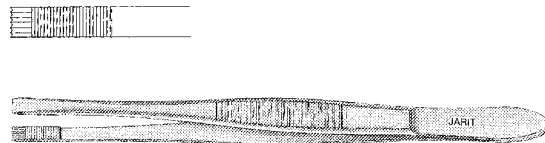

### Potts-Smith Dressing Forceps

serrated

Catalog #	Description
130-350	7" (180mm)
130-355	8¼" (209mm)
130-360	9¾" (249mm)
130-367	10¼" (260mm)
130-365	11¾" (300mm)

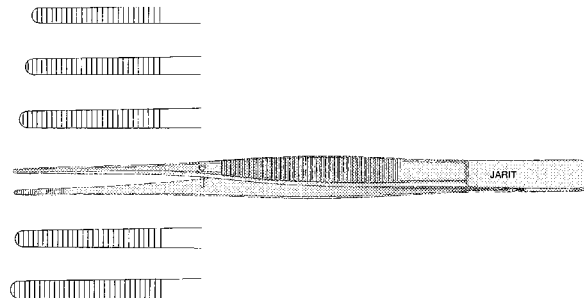

**Potts-Smith Tissue Forceps**

1 x 2 teeth, serrated

Catalog #	Description
130-352	7¼" (184mm)
130-357	8¼" (210mm)
130-362	9¾" (249mm)
130-368	10¼" (260mm)
130-366	12" (305mm)

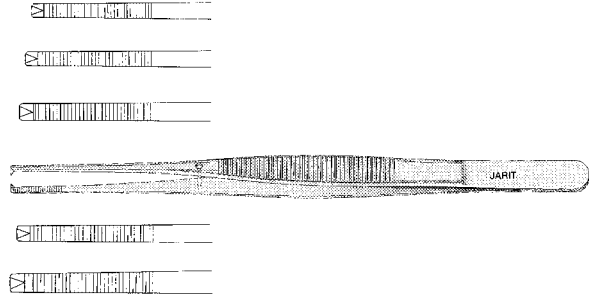

**Potts-Smith Tissue Forceps, Carb-Bite**

Catalog #	Description
130-353	7¼" (184mm)
130-358	8" (202mm)
130-363	9½" (241mm)
130-369	10¼" (261mm)

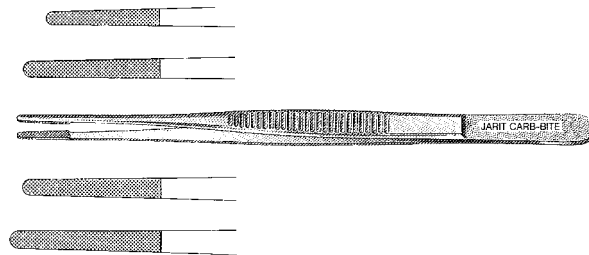

**Nelson Tissue Forceps**

6 x 7 teeth

Catalog #	Description
130-370	6" (152mm)
130-375	7" (178mm)
130-380	9" (228mm)

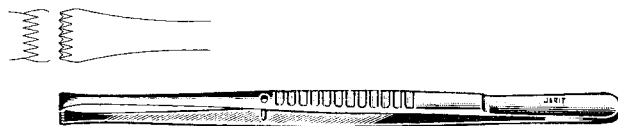

**Evans Tissue Forceps, Carb-Bite**

Catalog #	Description
130-383	9¾" (250mm), straight, 1.9mm wide x 16mm length serrated tips

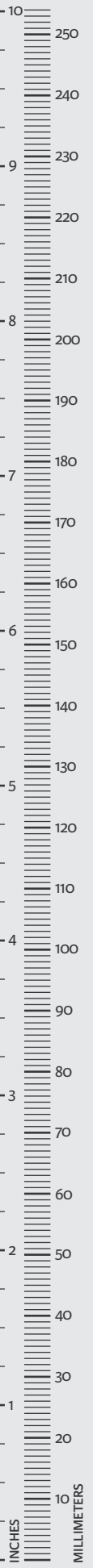
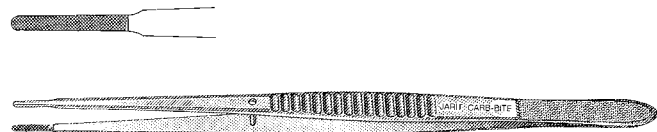

### Russian Tissue Forceps, (Mirror Finish)

Manufactured from high grade German surgical stainless steel which is ground and polished to a mirror finish

Catalog #	Description
130-390	5 <sup>7</sup> / <sub>8</sub> " (150mm)
130-392	7 <sup>3</sup> / <sub>4</sub> " (200mm)
130-395	10 <sup>1</sup> / <sub>4</sub> " (258mm)
130-394	12" (305mm)
130-396	14" (355mm)

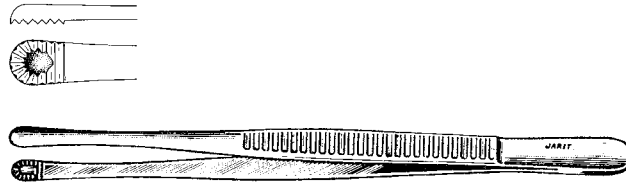

### Russian Tissue Forceps, (Matte Finish)

Manufactured from high grade German surgical stainless steel which is glass beaded to a matte finish

Catalog #	Description
129-390	5 <sup>7</sup> / <sub>8</sub> " (150mm)
129-392	7 <sup>3</sup> / <sub>4</sub> " (200mm)
129-395	10 <sup>1</sup> / <sub>4</sub> " (258mm)

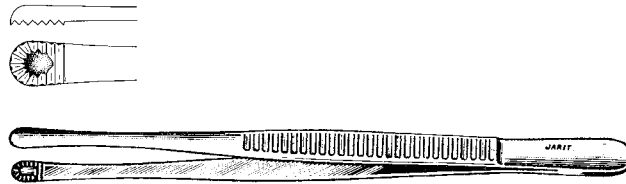

### Mayo-Russian Tissue Forceps

Catalog #	Description
130-397	9" (228mm)

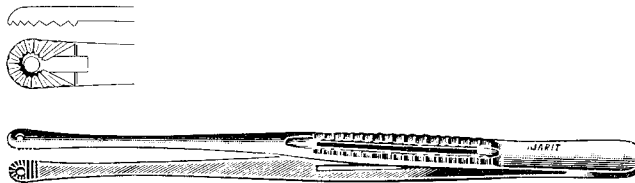

### Cushing Dressing Forceps

straight, serrated, scraper end

Catalog #	Description
130-400	6 <sup>3</sup> / <sub>4</sub> " (170mm), 1.5mm tip
130-445	7 <sup>3</sup> / <sub>4</sub> " (200mm), 2mm tip

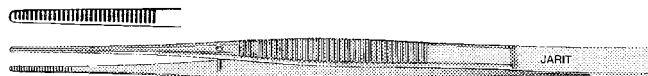

**Cushing Tissue Forceps**

straight, 1 x 2 teeth, scraper end

Catalog #	Description
130-405	6 3/4" (171mm), 1.5mm tip
130-446	7 3/4" (200mm), cross serrated, 2mm tip

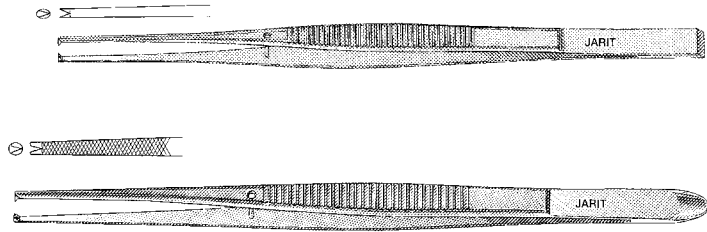

**Cushing Dressing Forceps**

bayonet, serrated, scraper end

Catalog #	Description
130-410	7 1/4" (183mm)
130-420	7 3/4" (200mm)

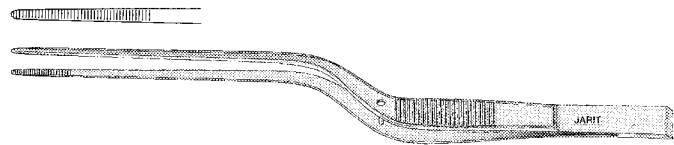

**Cushing Tissue Forceps**

bayonet, 1 x 2 teeth, scraper end

Catalog #	Description
130-415	7 1/4" (181mm)
130-421	7 3/4" (200mm)

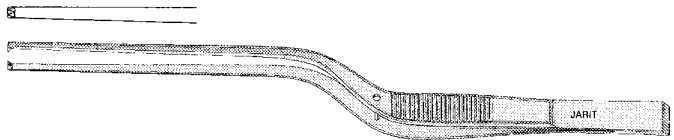

**Cushing Tissue Forceps**

Gutsch handle, straight, scraper end

Catalog #	Description
130-425	7" (178mm), serrated
130-430	7" (178mm), 1 x 2 teeth
130-435	7" (178mm), 1 x 2 teeth, serrated



### Cushing Needle and Tissue Pulling Forceps, Carb-Bite

straight, Gutsch handle, scraper end

Catalog #	Description
122-530	7" (176mm), Gutsch handle, scraper end, 1.8mm wide x 12mm length tips
122-535	7" (176mm), delicate, 1.6mm wide x 8mm length tips



### Cushing Tissue Forceps, Carb-Bite

angled, Gutsch handle, scraper end

Catalog #	Description
130-417	7" (176mm), 1.8mm wide x 12mm length tips

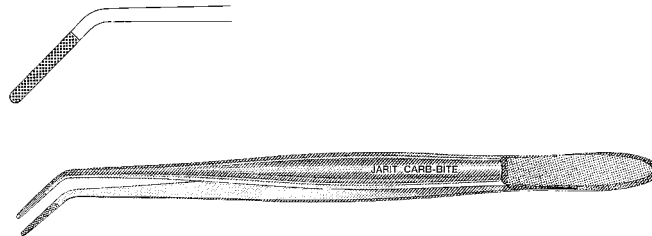

### Cushing Tissue Forceps, Carb-Bite

bayonet, scraper end

Catalog #	Description
130-418	7½" (191mm), 1.8mm wide x 14mm length tips

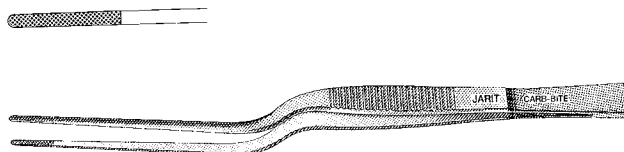

**Reul Coronary Tissue Forceps, Carb-Bite**  
delicate

Catalog #	Description
130-437	8" (206mm), 1.6mm wide x 12mm length tips

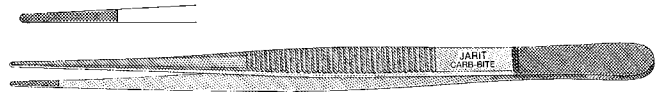

**Cushing-Brown Tissue Forceps**  
straight, double row of 9 x 9 delicate teeth, scraper end

Catalog #	Description
130-440	6¾" (174mm)

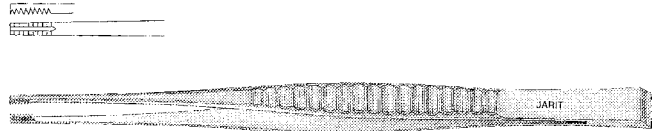

**Cushing-Brown Tissue Forceps**  
bayonet, double row of 9 x 9 delicate teeth, scraper end

Catalog #	Description
130-442	7" (180mm)

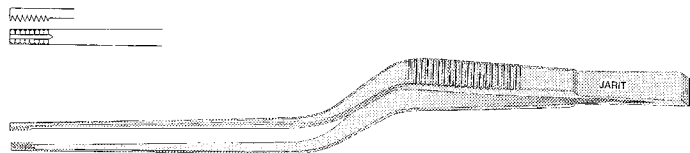



### Singley Tissue Forceps

Catalog #	Description
135-250	9" (229mm)
135-248	14" (356mm)

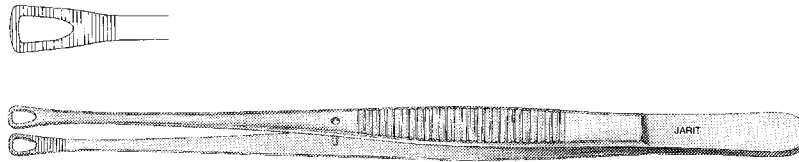

### Selman Tissue Forceps

3.8mm round cup with teeth

Catalog #	Description
135-252	6" (155mm)
135-253	8" (205mm)
135-254	9¾" (250mm)

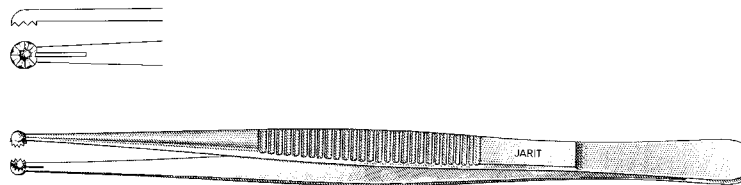

### Wangensteen Tissue Forceps, Carb-Bite

Catalog #	Description
135-256	6" (151mm), 4.8mm wide x 15.7mm length tips
135-257	9" (230mm), 5mm wide x 18mm length tips
135-258	10" (257mm), 6mm wide x 18mm length tips

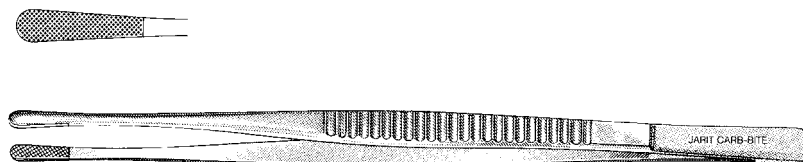

**Jacobson Forceps, Bayonet Handle**

6 1/4" (160mm)

Catalog #	Description
277-159	Sharp tips

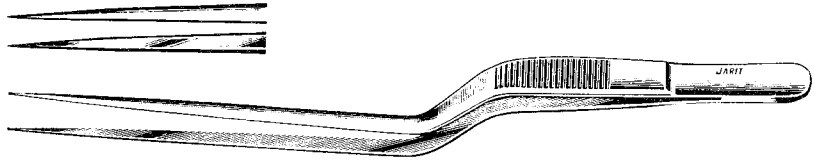

**Jacobson Forceps, Bayonet Handle**

7 1/4" (185mm)

Catalog #	Description
277-160	Blunt tips (0.8mm)
277-161	Sharp tips (0.3mm)
277-162	Angled blunt tips (0.8mm)

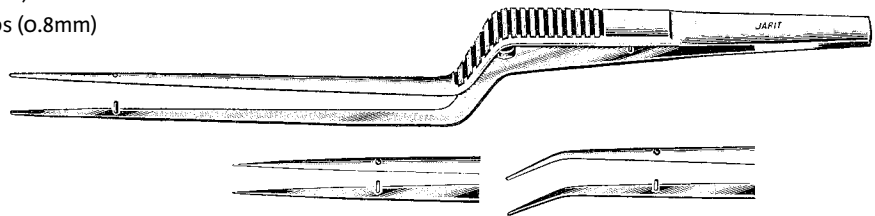

**Hoen Dressing and Tissue Forceps, Bayonet Handle**

7 3/4" (200mm)

Catalog #	Description
285-116	Serrated, 19mm length tips
285-117	1 x 2 teeth

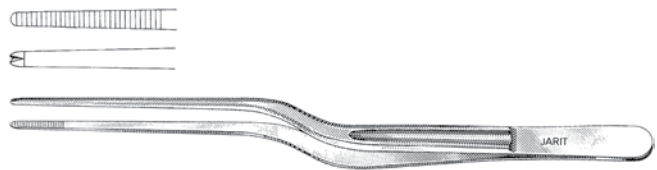

**Brain Dressing and Tissue Forceps**

7" (176mm)

Catalog #	Description
285-118	Serrated
285-119	1 x 2 teeth

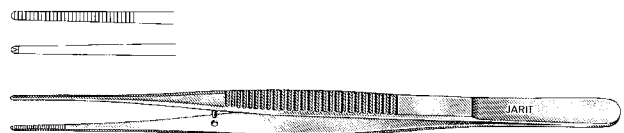

**Gerald Dressing Forceps**

narrow tips, serrated

Catalog #	Description
285-120	7" (175mm), straight, 1.3mm tips
285-121	7" (175mm), curved, 1.3mm tips
285-122	7 1/2" (192mm), bayonet, 1.2mm tips
285-128	9 1/4" (233mm), straight, 1.1mm tips

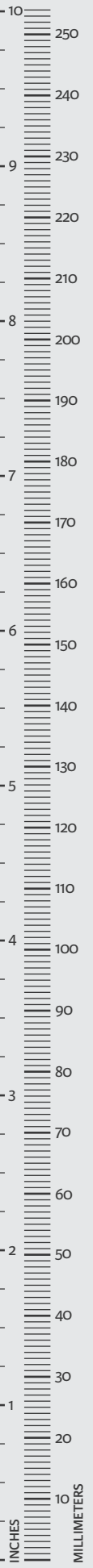
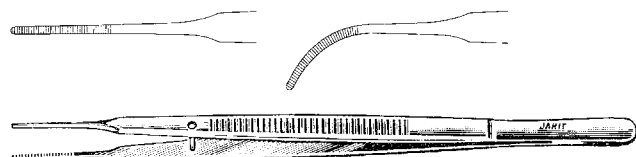

### Gerald Tissue Forceps

narrow tips, 1 x 2 teeth

Catalog #	Description
285-125	7" (176mm), straight, 1.3mm tips
285-127	7½" (192mm), bayonet, 1.4mm tips
285-129	9¼" (233mm), straight, 1.4mm tips

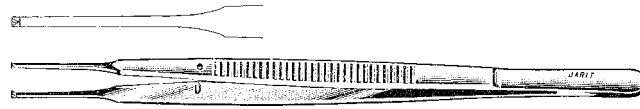

### Gerald Dressing Forceps, Cardio-Grip

narrow tips, serrated

Catalog #	Description
285-126	7" (180mm)
285-130	9½" (240mm), 24mm length serrated tips

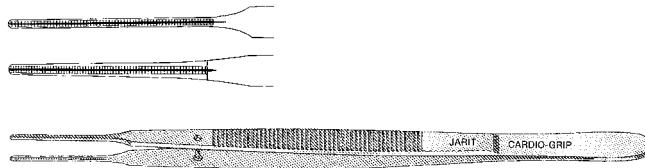

### Adson Dressing Forceps, Bayonet

Catalog #	Description
285-140	7¾" (196mm), 2.4mm wide x 20mm length tips

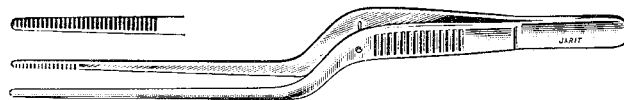

### D'Errico Dressing and Tissue Forceps, Bayonet Handle

8¾" (222mm)

Catalog #	Description
285-147	Serrated, 3mm wide x 18mm length tips
285-148	1 x 2 teeth, 2.5mm wide tips

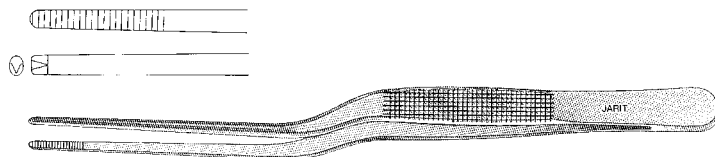

### Adson Hypophyseal Forceps

bayonet shape

Catalog #	Description
285-170	9" (229mm), straight, 6mm round cup
285-171	8¾" (225mm), curved up, 6mm round cup
285-172	8¾" (225mm), curved down, 6mm round cup

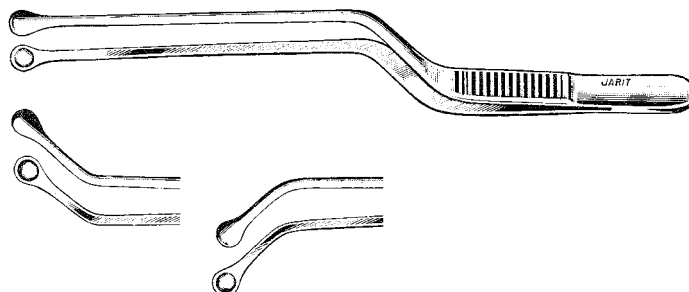

**Eye Dressing Forceps, Delicate Pattern**

3 7/8" (99mm), 0.5mm wide tip

Catalog #	Description
355-090	Straight
355-091	Half curved
355-092	Full curved

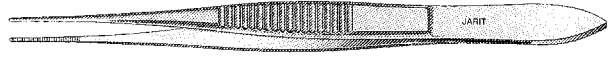

**Eye Dressing Forceps, Standard Pattern**

3 7/8" (99mm), 0.8mm wide tip

Catalog #	Description
355-100	Straight
355-101	Half curved
355-102	Full curved

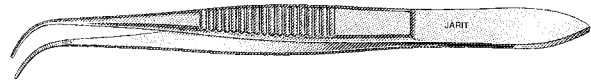
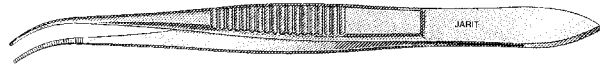

**Iris Tissue Forceps, Delicate Pattern**

3 7/8" (99mm), 0.6mm wide at tip, 1 x 2 teeth

Catalog #	Description
355-095	Straight
355-096	Half curved
355-097	Full curved

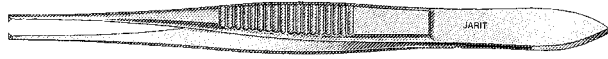

**Iris Tissue Forceps, Standard Pattern**

3 7/8" (99mm), 0.8mm wide tip, 1 x 2 teeth

Catalog #	Description
355-110	Straight
355-111	Half curved
355-112	Full curved

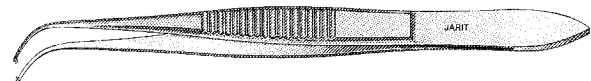
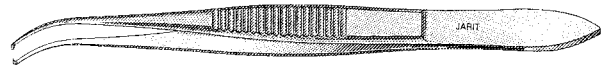

### Lucae Ear Dressing Forceps

Catalog #	Description
380-100	5½" (140mm), 1.8mm wide x 16mm length serrations

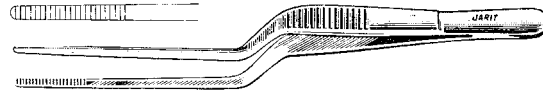

### Jansen Ear Dressing Forceps

Catalog #	Description
380-105	6¼" (161mm), 2mm wide x 17mm length serrations

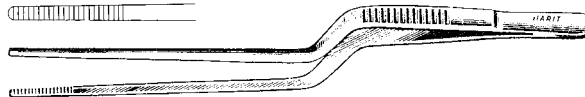

### Wilde Ear Dressing Forceps

Catalog #	Description
380-110	4¾" (117mm), 2mm wide x 14.5mm length serrations

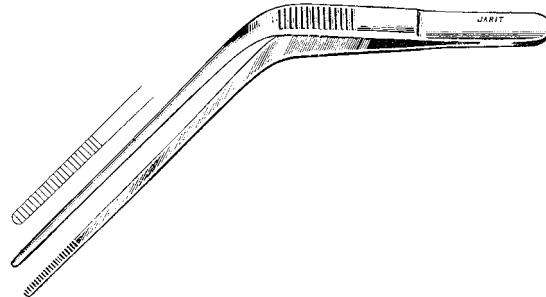

### Jansen Nasal Dressing Forceps

Catalog #	Description
400-150	7¾" (195mm), 2.5mm wide x 18mm length serrations

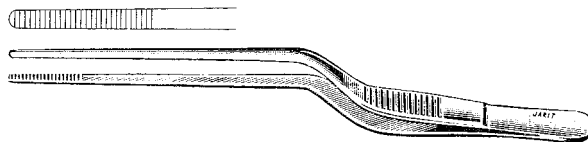

**Gruenwald Nasal Dressing Forceps**

Catalog #	Description
400-152	8½" (214mm), 2.2mm wide x 20mm length serrations

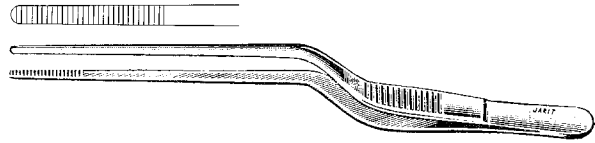

**Wilde Nasal Dressing Forceps**

Catalog #	Description
400-155	6¼" (158mm), 1.7mm wide x 15.5mm length serrations

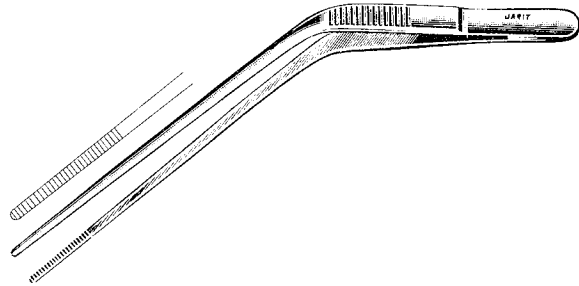

**Jewelers Disposable Bipolar Forcep (insulated)**

Catalog #	Description
286-100	4½" (114mm), straight, 0.4mm tip with 12' cord, 10/per



**Jewelers Disposable Bipolar Forcep (non-insulated)**

Catalog #	Description
286-101	4½" (114mm), straight, 0.4mm tip with 12' cord, 10/per



**Adson Disposable Bipolar Forceps (insulated)**

Catalog #	Description
286-102	4¾" (121mm), smooth, 1.0mm tip with 12' cord, 10/per



**Adson Disposable Bipolar Forceps (non-insulated)**

Catalog #	Description
286-103	4¾" (121mm), smooth, 1.0mm tip with 12' cord, 10/per



**Cushing Disposable Bayonet Bipolar Forcep (insulated)**

Catalog #	Description
286-104	7½" (190mm), smooth, 3½" (90mm) working length, 0.7mm tip with 12' cord, 10/per



**Cushing Disposable Bayonet Bipolar Forcep (non-insulated)**

Catalog #	Description
286-105	7½" (190mm), smooth, 3½" (90mm) working length, 0.7mm tip with 12' cord, 10/per



**Scoville Disposable Bayonet Bipolar Forcep (insulated)**

Catalog #	Description
286-106	7¾" (197mm), smooth, 2¾" (70mm) working length, 1.5mm tip with 12' cord, 10/per





### Scoville Disposable Bayonet Bipolar Forcep (non-insulated)

Catalog #	Description
286-107	7¾" (197mm), smooth, 2¾" (70mm) working length, 1.5mm tip with 12' cord, 10/per



### Hardy Disposable Bayonet Bipolar Forcep (insulated)

Catalog #	Description
286-108	8½" (215mm), smooth, 4½" (115mm) working length, 1.5mm tip with 12' cord, 10/per



### Hardy Disposable Bayonet Bipolar Forcep (non-insulated)

Catalog #	Description
286-109	8½" (215mm), smooth, 4½" (115mm) working length, 1.5mm tip with 12' cord, 10/per



**Hardy Disposable Bayonet Bipolar Forcep (insulated)**

Catalog #	Description
286-110	8½" (215mm), smooth, 4½" (115mm) working length, 0.5mm tip with 12' cord, 10/per



**Hardy Disposable Bayonet Bipolar Forcep (non-insulated)**

Catalog #	Description
286-111	8½" (215mm), smooth, 4½" (115mm) working length, 0.5mm tip with 12' cord, 10/per



**Disposable 12' Bipolar Cord with Banana Pin Connector**

Catalog #	Description
286-112	10/per

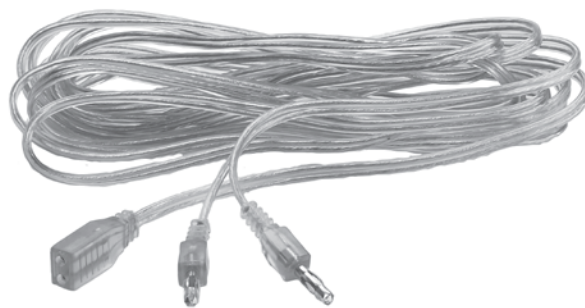

### Plain Splinter Forceps

Catalog #	Description
130-500	3 <sup>3</sup> / <sub>8</sub> " (87 mm)
130-505	4 <sup>5</sup> / <sub>8</sub> " (118mm)

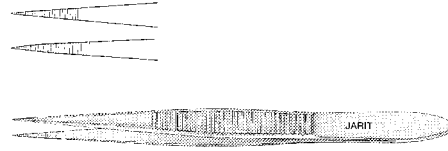

### Feilchenfeld Splinter Forceps

Catalog #	Description
130-510	3 <sup>1</sup> / <sub>8</sub> " (79 mm)
130-515	4 <sup>1</sup> / <sub>2</sub> " (115mm)

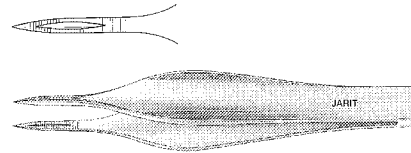

### Carmalt Splinter Forceps

Catalog #	Description
130-520	4 <sup>1</sup> / <sub>8</sub> " (106mm), straight
130-525	4 <sup>1</sup> / <sub>8</sub> " (106mm), angled

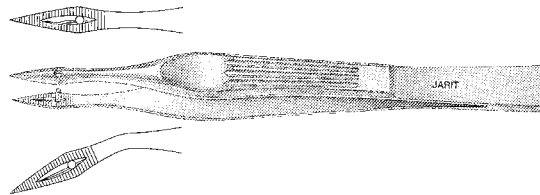

### Virtus Splinter Forceps

Catalog #	Description
130-530	5 <sup>7</sup> / <sub>8</sub> " (150mm), straight

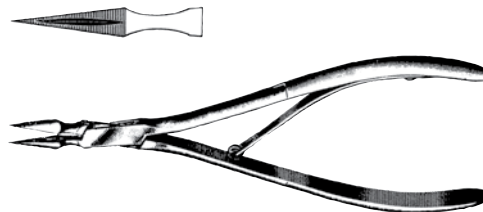

### Williams Splinter Forceps

Catalog #	Description
130-535	5 <sup>3</sup> / <sub>8</sub> " (135 mm), angled

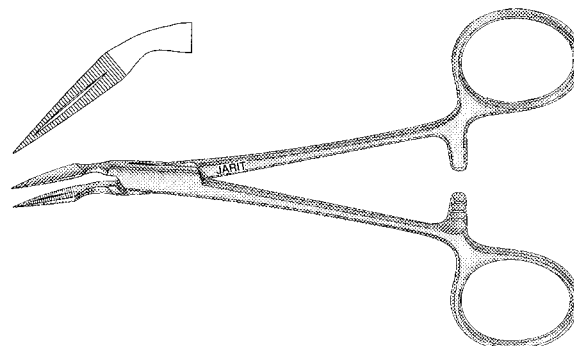

**Petit-Point Allis Tissue Forceps**

Catalog #	Description
135-095	5" (130mm), 4 x 5 teeth, 3mm wide jaws

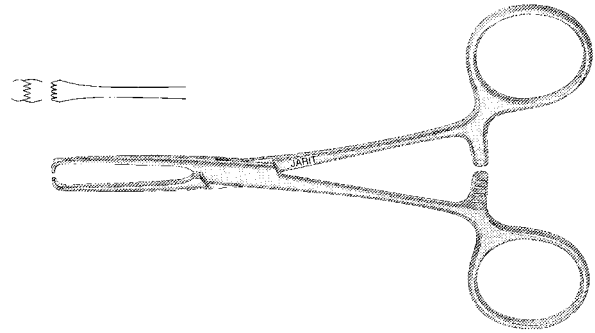

**Allis Tissue Forceps, (Mirror Finish)**

Manufactured from high grade German surgical stainless steel which is ground and polished to a mirror finish

Catalog #	Description
135-100	6¼" (156mm), 4 x 5 teeth, 5.75mm wide jaws
135-105	6¼" (156mm), 5 x 6 teeth, 7mm wide jaws

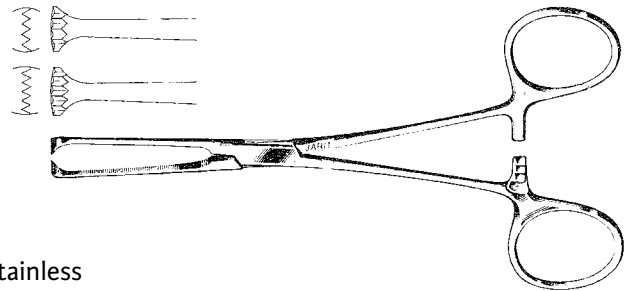

**Allis Tissue Forceps, (Matte Finish)**

Manufactured from high grade German surgical stainless steel which is glass beaded to a matte finish

Catalog #	Description
136-100	6¼" (156mm), 4 x 5 teeth, 5.75mm wide jaws
136-105	6¼" (156mm), 5 x 6 teeth, 7mm wide jaws

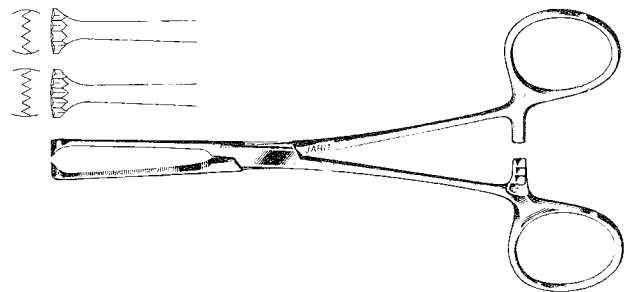

**Allis Tissue Forceps**

Catalog #	Description
135-109	7" (180mm), 90 deg angle, 5 x 6 teeth, 6mm wide jaws



**Allis Tissue Forceps, (Mirror Finish)**

Manufactured from high grade German surgical stainless steel which is ground and polished to a mirror finish

Catalog #	Description
135-110	7½" (190mm), 5 x 6 teeth, 7.2mm wide jaws
135-111	7¾" (197mm), 5 x 6 teeth, delicate, 5.4mm wide jaws

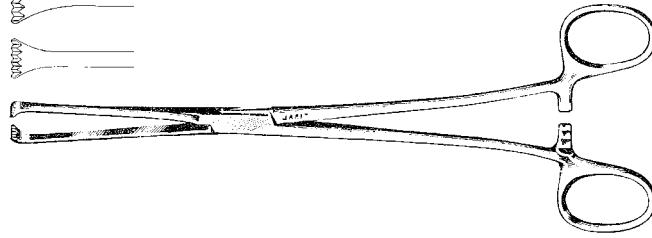
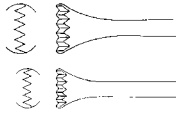

**Allis Tissue Forceps, (Matte Finish)**

Manufactured from high grade German surgical stainless steel which is glass beaded to a matte finish

Catalog #	Description
136-110	7½" (190mm), 5 x 6 teeth, 7.2mm wide jaws

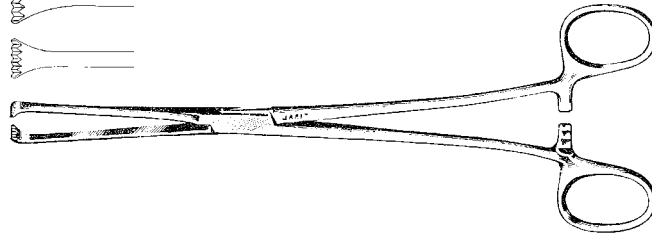
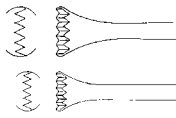

**Allis Atraumatic Tissue Forceps**

2 rows of fine, non-traumatic teeth

Catalog #	Description
135-107	6" (154mm), 7.3mm wide jaws

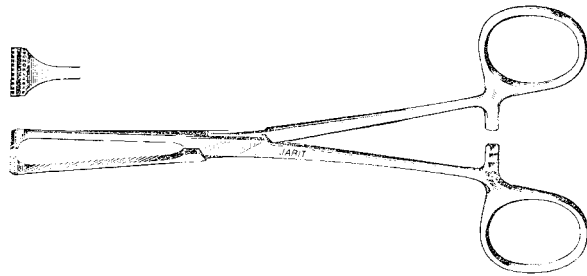

**Judd-Allis Tissue Forceps**

3 x 4 teeth

Catalog #	Description
135-115	6¼" (156mm), 4mm wide jaws
135-120	7½" (192mm), 4.3mm wide jaws

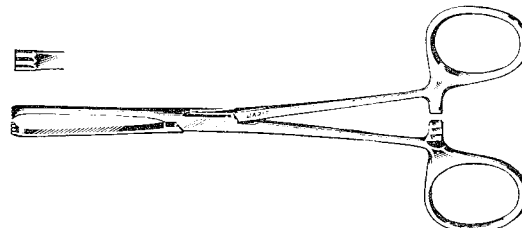

**Thoms-Allis Tissue Forceps**

6 x 7 teeth

Catalog #	Description
135-125	8" (203mm), 7.25mm wide jaws

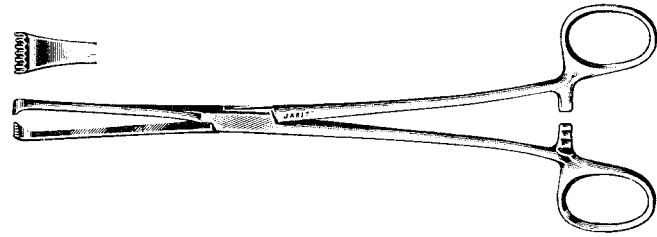

**Boys-Allis Tissue Forceps**

5 x 6 teeth

Catalog #	Description
135-127	6" (154mm), 5.2mm wide jaws

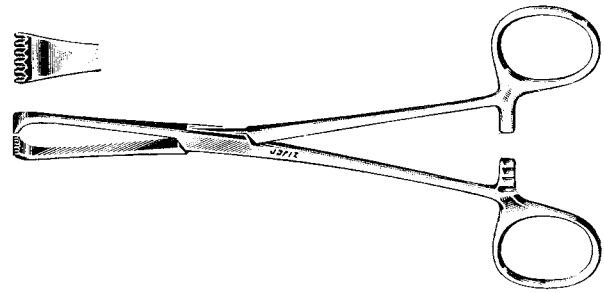

**Allis-Adair Tissue Forceps**

9 x 10 teeth

Catalog #	Description
135-130	6 1/4" (162mm), 10mm wide jaws

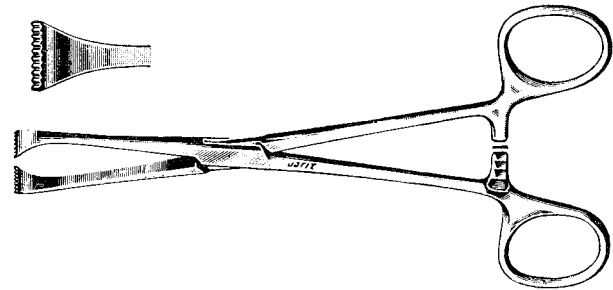

**Lockwood-Allis Tissue Forceps**

Catalog #	Description
135-135	6 1/4" (159mm), 6mm wide jaws

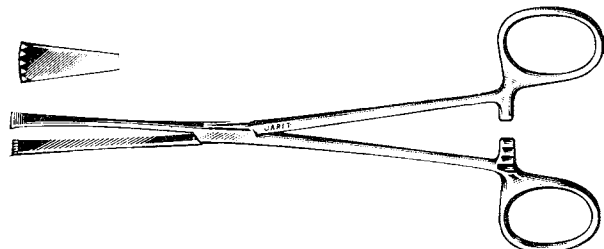

### Collins Tissue Forceps

Catalog #	Description
135-150	8" (203mm), 5/8" (16mm) wide jaws
135-155	8" (203mm), 1" (26mm) wide jaws

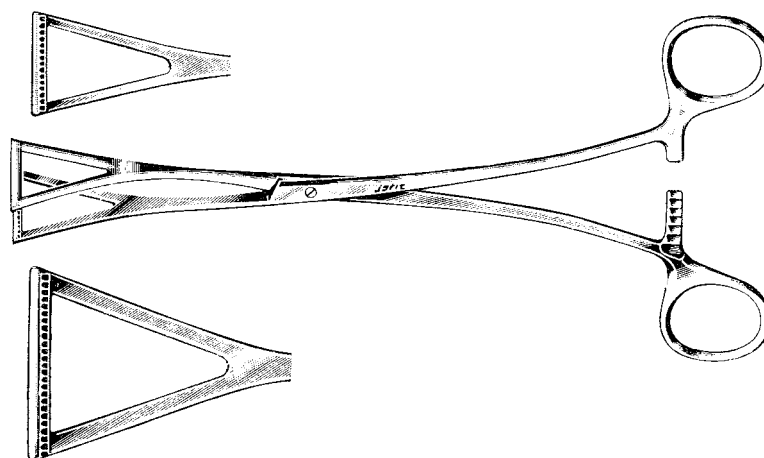

### Williams Tissue Forceps

Catalog #	Description
135-175	6 1/2" (165mm)

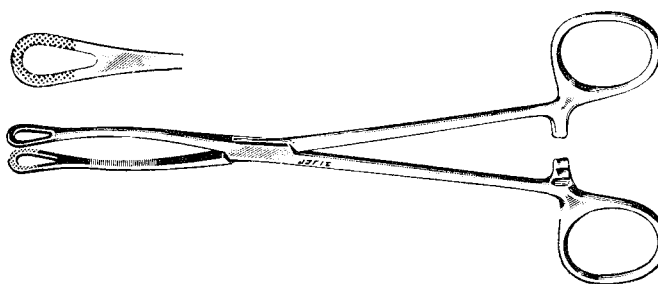

### Petit-Point Babcock Tissue Forceps

Catalog #	Description
135-179	5 7/8" (148mm), 5.6mm wide jaws
135-180	6" (155mm), 7.5mm wide jaws

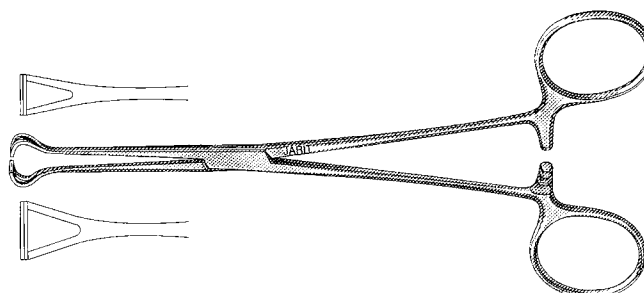

**Babcock Tissue Forceps, (Mirror Finish)**

Manufactured from high grade German surgical stainless steel which is ground and polished to a mirror finish

Catalog #	Description
135-181	6" (155mm), 8mm wide jaws
135-185	7¼" (185mm), 10.5mm wide jaws
135-190	8" (203mm), 11mm wide jaws
135-195	9½" (242mm), 11.75mm wide jaws
135-196	11¾" (300mm), 11.3mm wide jaws
135-194	13¾" (350mm), 12mm wide jaws

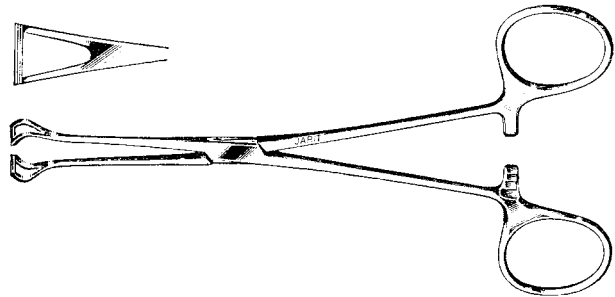

**Babcock Tissue Forceps, (Matte Finish)**

Manufactured from high grade German surgical stainless steel which is glass beaded to a matte finish

Catalog #	Description
136-181	6" (155mm), 8mm wide jaws
136-190	8" (203mm), 11mm wide jaws

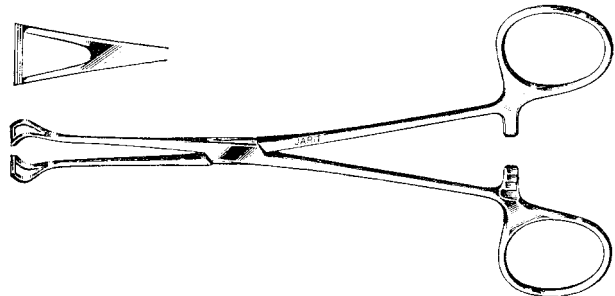

**Babcock Tissue Forceps, Carb-Bite**

Catalog #	Description
135-182	6½" (164mm), 8.5mm wide jaws
135-191	8¼" (210mm), 10.5mm wide jaws

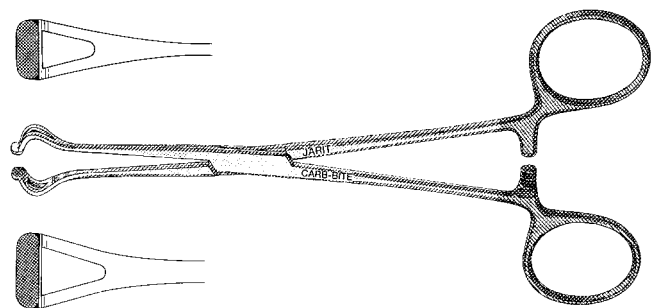



### Benson Pylorus Spreader

Catalog #	Description
135-615	6¼" (160mm)

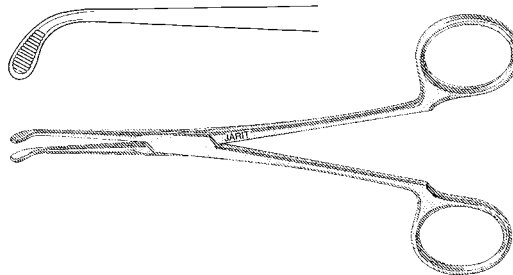

### Adair Breast Clamp

Catalog #	Description
135-197	7¼" (182mm)

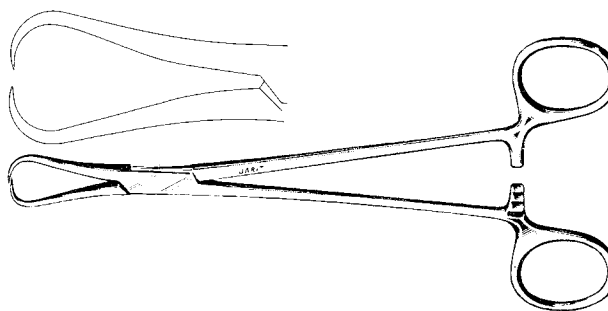

**Pean Forceps**

horizontal serrations

Catalog #	Description
135-260	10" (256mm), straight, jaw length 3½" (87.5mm)
135-261	10" (256mm), curved, jaw length 3½" (87.5mm)
135-262	11" (280mm), straight, jaw length 3½" (87.5mm)
135-265	11" (280mm), curved, jaw length 3½" (87.5mm)
135-263	12" (305mm), straight, jaw length 3½" (87.5mm)
135-266	12" (305mm), curved, jaw length 3½" (87.5mm)
135-264	14" (356mm), straight, jaw length 3½" (87.5mm)
135-267	14" (356mm), curved, jaw length 3½" (87.5mm)

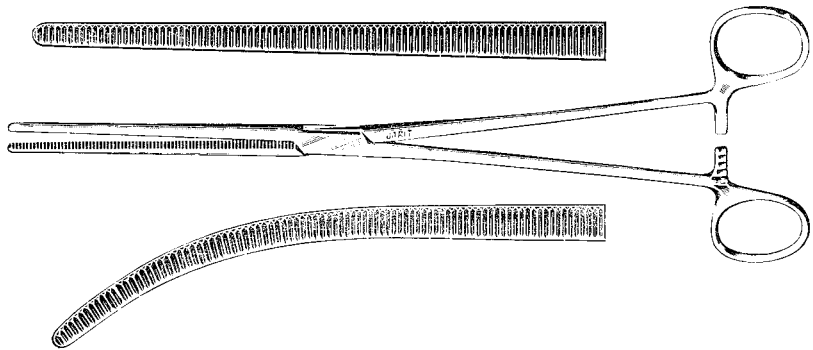

**Pean Forceps**

longitudinal serrations

Catalog #	Description
135-270	8" (205mm), straight, jaw length 2½" (63mm)
135-271	8" (205mm), curved, jaw length 2½" (63mm)
135-275	8¾" (225mm), straight, jaw length 3" (75mm)
135-276	8¾" (225mm), curved, jaw length 3" (75mm)
135-280	10" (255mm), straight, jaw length 3¾" (86mm)
135-281	10" (255mm), curved, jaw length 3¾" (86mm)

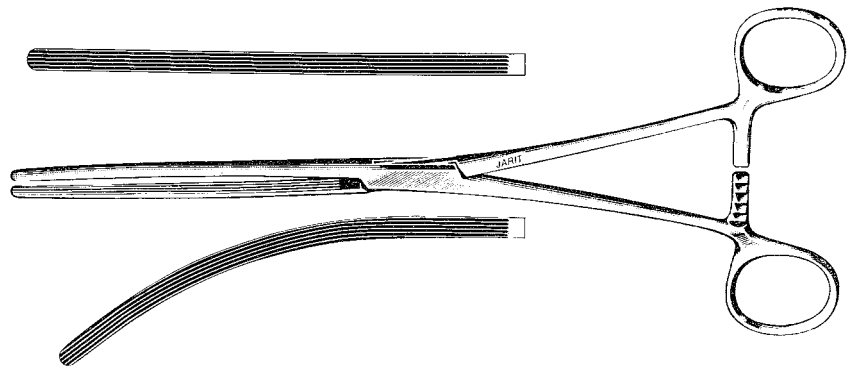

### Allen Intestinal Clamps

longitudinal serrations, 1 x 2 teeth

Catalog #	Description
135-300	8" (205mm), jaw length 2 <sup>3</sup> / <sub>8</sub> " (60mm)
135-301	6 <sup>1</sup> / <sub>4</sub> " (160mm), jaw length 2 <sup>1</sup> / <sub>8</sub> " (54mm), pediatric

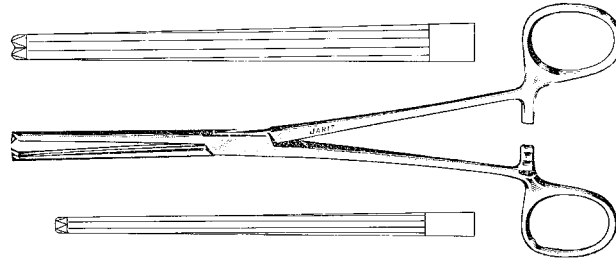

### Dennis Anastomosis Clamp

Catalog #	Description
135-305	9 <sup>1</sup> / <sub>4</sub> " (234mm), jaw length 2 <sup>1</sup> / <sub>8</sub> " (54mm)

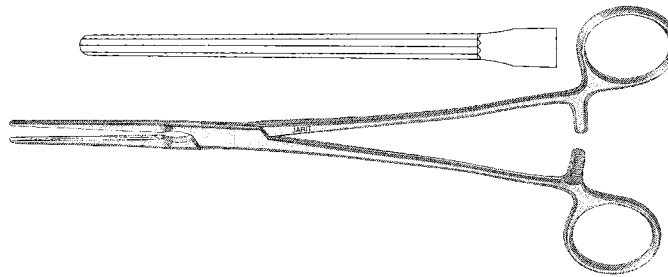

### Baby Doyen Intestinal Clamps

diagonal serrations

Catalog #	Description
135-340	7" (175mm), straight, 61mm jaws
135-345	6 <sup>3</sup> / <sub>4</sub> " (171mm), curved, 61mm jaws

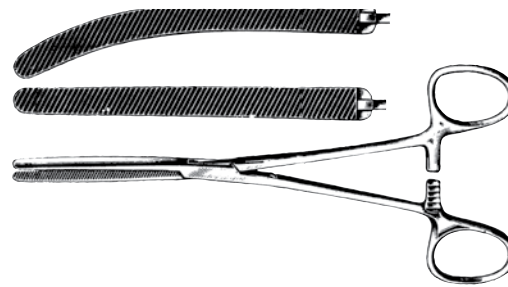

### Doyen Intestinal Clamps

diagonal serrations

Catalog #	Description
135-350	9 <sup>1</sup> / <sub>4</sub> " (233mm), jaw length 4 <sup>1</sup> / <sub>8</sub> " (105mm), straight
135-355	9" (228mm), jaw length 3 <sup>7</sup> / <sub>8</sub> " (95mm), curved

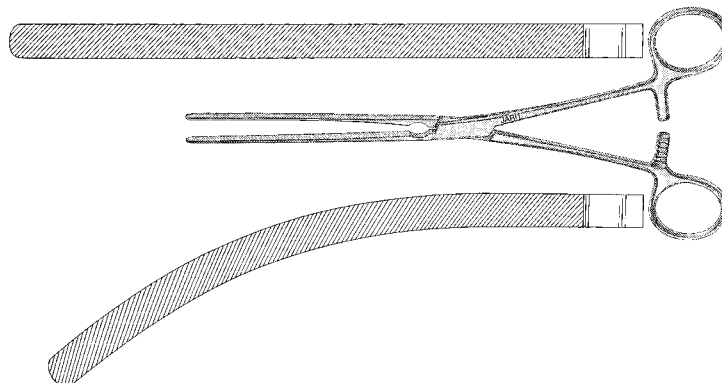

**Doyen Intestinal Clamps, Cardio-Grip**

Catalog #	Description
325-150	9½" (240mm), jaw length 3⅞" (98mm), straight
325-151	9½" (240mm), jaw length 3⅞" (98mm), curved

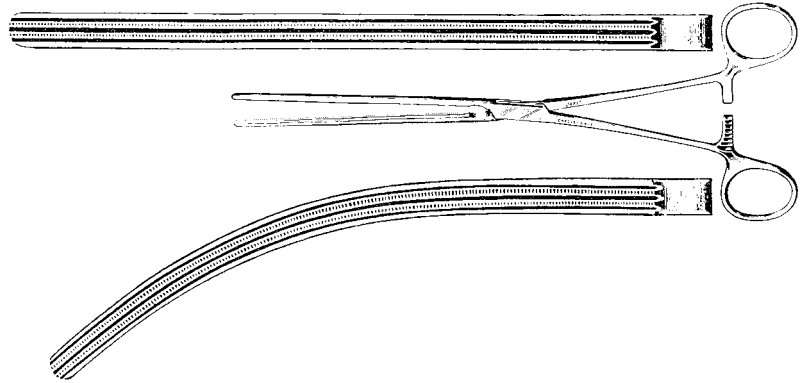

**Mayo-Robson Intestinal Clamp**  
longitudinal serrations

Catalog #	Description
135-370	10" (252mm), jaw length 4½" (114mm), straight
135-375	9¾" (245mm), jaw length 4¼" (107mm), curved

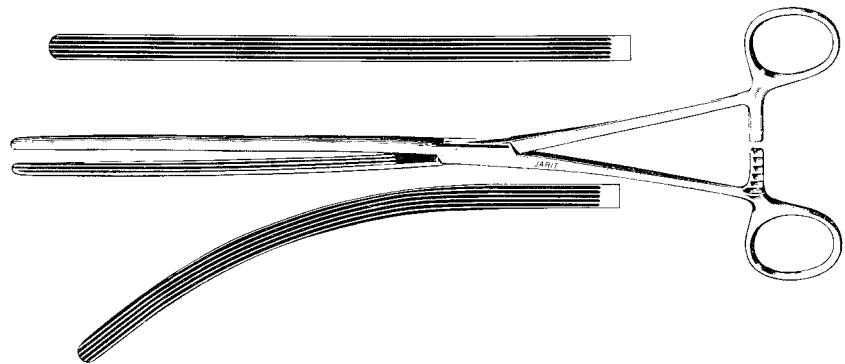

### Fehland Intestinal Clamp

Catalog #	Description
135-400	10" (257mm), jaw length 3½" (89mm)

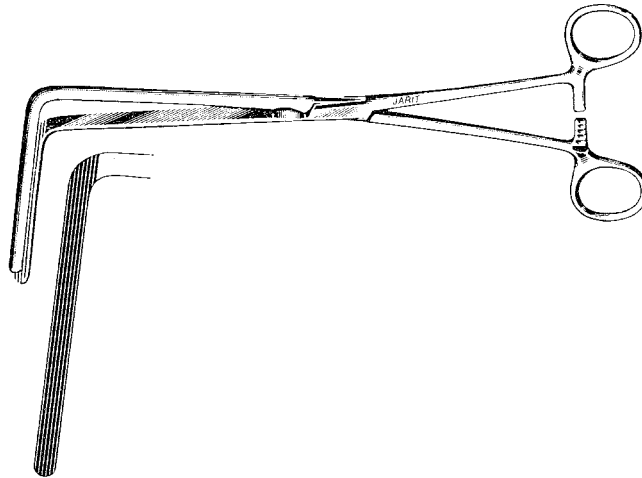

### Stone Intestinal Clamp with locking device

Catalog #	Description
135-430	3¾" (85mm)
135-435	4¾" (110mm)



### Stone Clamp Locking Device

Catalog #
135-440



### Stone Clamp Applying Forceps

Catalog #	Description
135-445	6¼" (156mm)

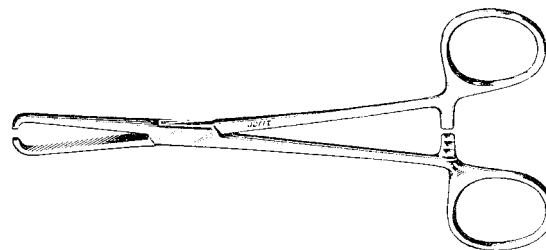

**Stone Intestinal Clamp Set**

includes: 2 applying forceps, 2 intestinal clamps, 2 locking devices

Catalog #	Description
135-450	3 <sup>3</sup> / <sub>8</sub> " (85mm)
135-451	4 <sup>3</sup> / <sub>8</sub> " (110mm)

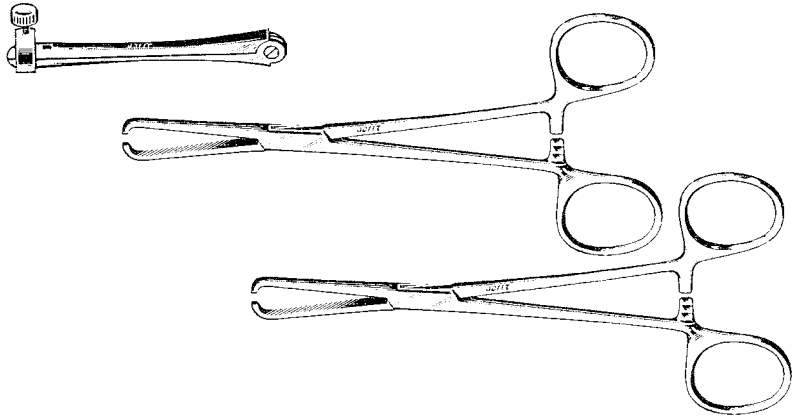

**Demartel-Wolfson Closing Forceps**

Catalog #	Description
135-500	9 <sup>3</sup> / <sub>4</sub> " (249mm)

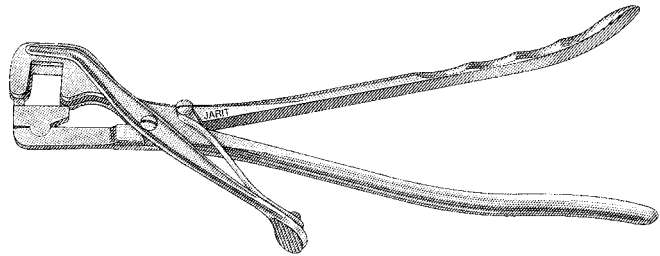

**Demartel-Wolfson Clamp Holder**

Catalog #	Description
135-502	2 <sup>1</sup> / <sub>2</sub> " (64mm)

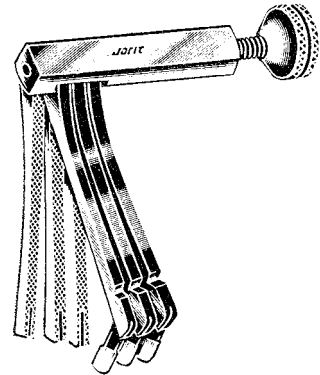

**Demartel-Wolfson Clamp Holder**

Catalog #	Description
135-504	7 <sup>3</sup> / <sub>4</sub> " (200mm)

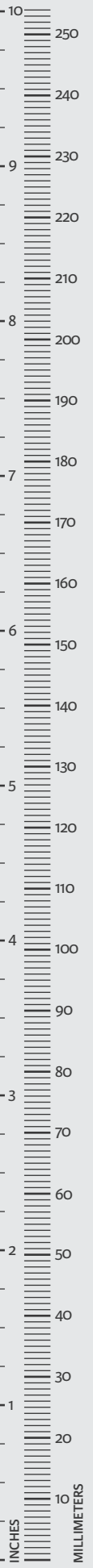
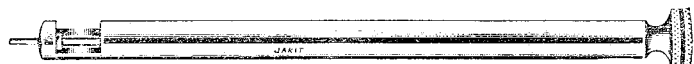

### Demartel-Wolfson Clamps

set of 3

Catalog #	Description
135-505	27/8" (74mm)
135-506	31/2" (89mm)
135-507	45/8" (118mm)

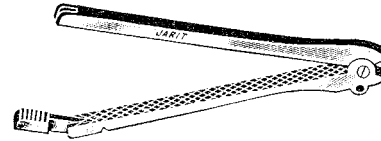

### Payr Pylorus Clamp, Pediatric

Catalog #	Description
135-598	61/4" (159mm), jaw length 21/4" (57mm)

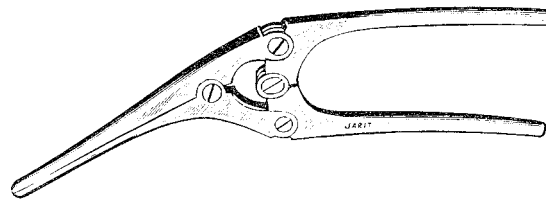

### Payr Pylorus Clamps

Catalog #	Description
135-600	8" (202mm), jaw length 21/2" (63mm)
135-605	103/4" (273mm), jaw length 4" (102mm)

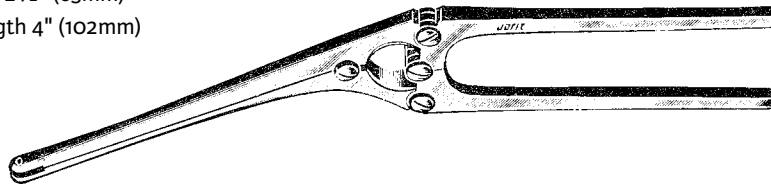

### Glassman Intestinal Clamps, Cardio-Grip

Catalog #	Description
325-140	91/4" (235mm), straight, jaw length 3" (75mm)
325-141	91/4" (233mm), angled 25°, jaw length 23/4" (70mm)

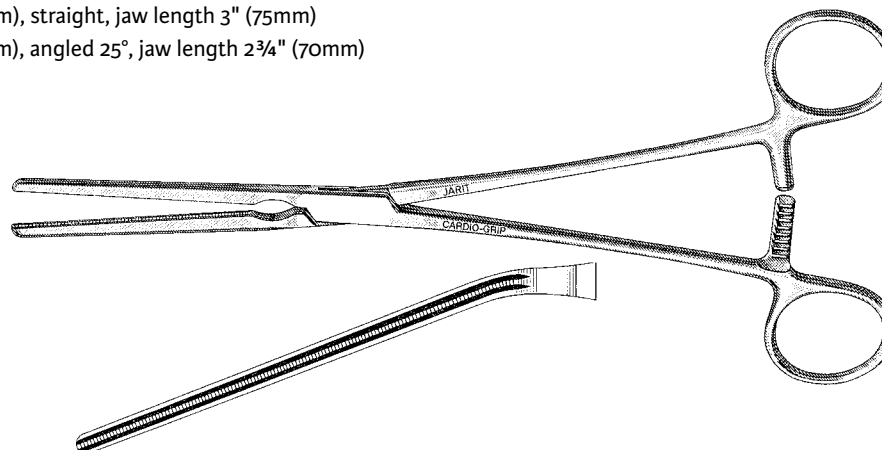

**Glassman Anterior Resection Clamps, Cardio-Grip**

Catalog #	Description
325-142	9 3/4" (250mm), jaw length 1" (25mm)
325-143	9 3/4" (250mm), jaw length 2" (52mm)
325-144	9 3/4" (250mm), jaw length 3" (75mm)

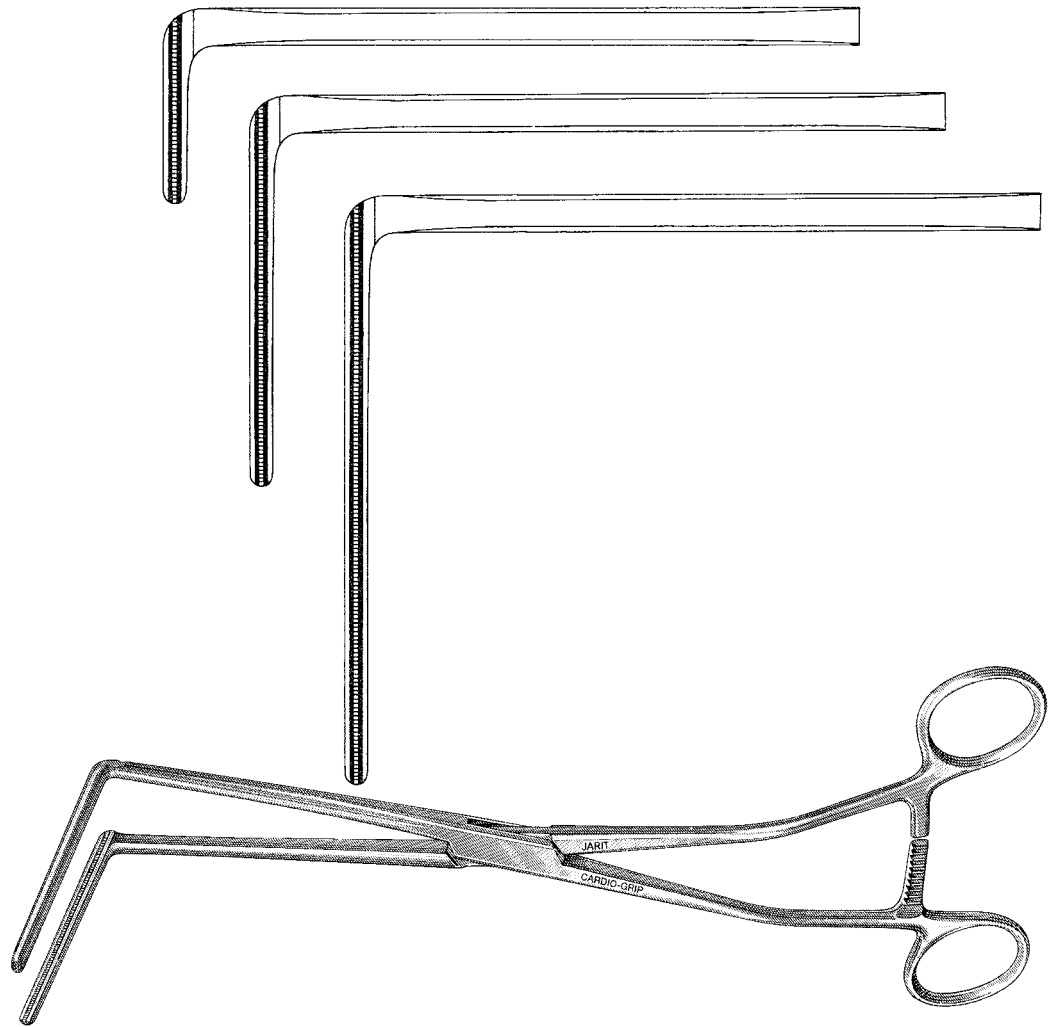



### Hausmann Clamps, Straight Shanks

Catalog #	Description
320-340	7½" (192mm), jaw size 7⁄8" x 5⁄16" (22 mm wide x 8mm deep)
320-341	7¾" (195mm), jaw size 1⅛" x 5⁄16" (30 mm wide x 8mm deep)
320-342	8" (203mm), jaw size 1¼" x 5⁄16" (33 mm wide x 8mm deep)
320-343	8" (203mm), jaw size 1½" x 5⁄16" (38 mm wide x 8mm deep)

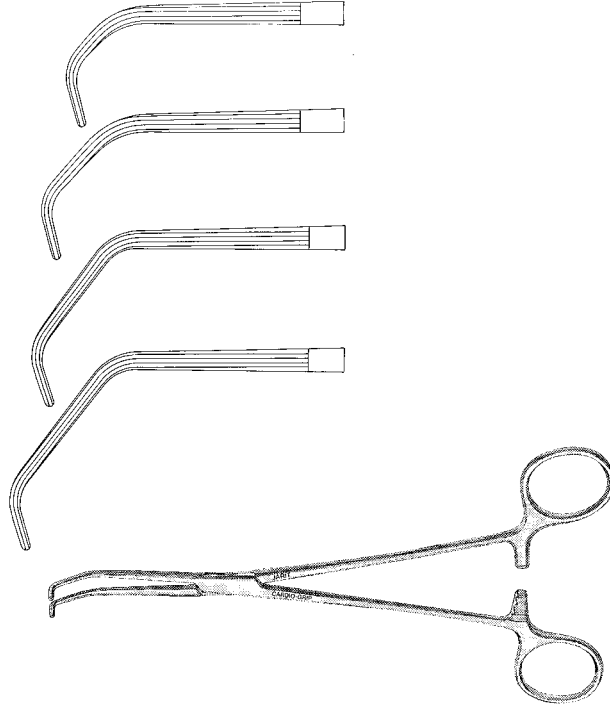

### Hausmann Clamps, Angled Shanks

Catalog #	Description
320-344	7½" (192mm), jaw size 7⁄8" x 5⁄16" (22 mm wide x 8mm deep)
320-345	7¾" (195mm), jaw size 1⅛" x 5⁄16" (30 mm wide x 8mm deep)
320-346	8" (203mm), jaw size 1¼" x 5⁄16" (33 mm wide x 8mm deep)
320-347	8" (203mm), jaw size 1½" x 5⁄16" (38 mm wide x 8mm deep)

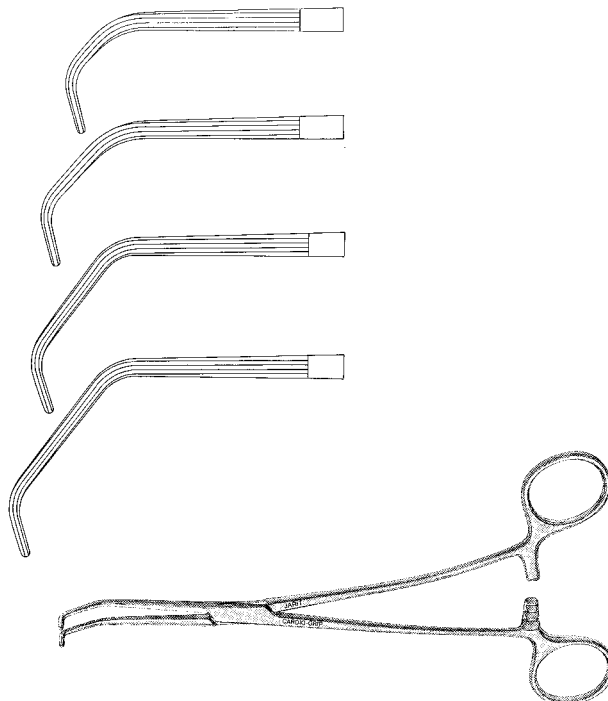

### Hausmann Clamps, Straight Shanks

Catalog #	Description
320-350	8½" (215mm), straight jaws 1.9mm wide tip x 65mm length
320-351	8½" (215mm), curved jaws, 1.9mm wide tip x 65mm length
320-352	8½" (215mm), spoon jaws, 1.9mm wide tip x 65mm length

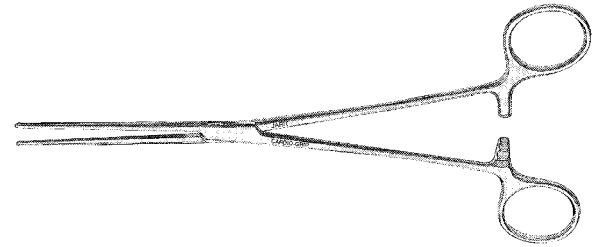
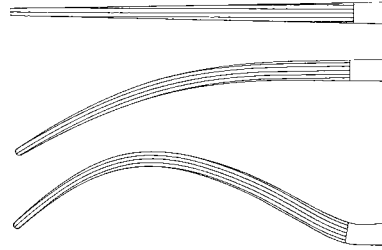

### Hausmann Clamps, Angled Shanks

Catalog #	Description
320-353	8" (203mm), straight jaws, 1.9mm wide tip x 65mm length
320-354	8½" (215mm), curved jaws, 1.9mm wide tip x 65mm length
320-355	8½" (215mm), spoon jaws, 1.9mm wide tip x 65mm length

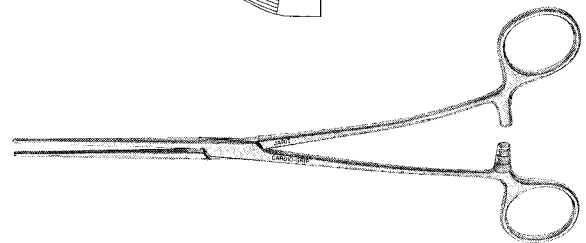
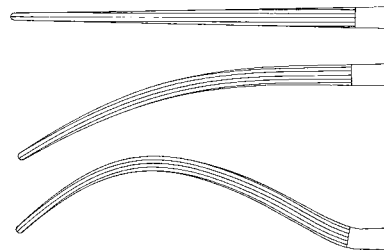

**Bakes Common Duct Dilators**

Catalog #	Description
140-100	8½" (215mm), set of 9
140-101	8½" (215mm), 3mm
140-102	8½" (215mm), 4mm
140-103	8½" (215mm), 5mm
140-104	8½" (215mm), 6mm
140-105	8½" (215mm), 7mm
140-106	8½" (215mm), 8mm
140-107	8½" (215mm), 9mm
140-108	8½" (215mm), 10mm
140-109	8½" (215mm), 11mm



**Ferguson Gall Stone Scoops**  
double-ended

Catalog #	Description
140-154	9½" (239mm), small
140-155	9½" (239mm), medium
140-156	9½" (239mm), large

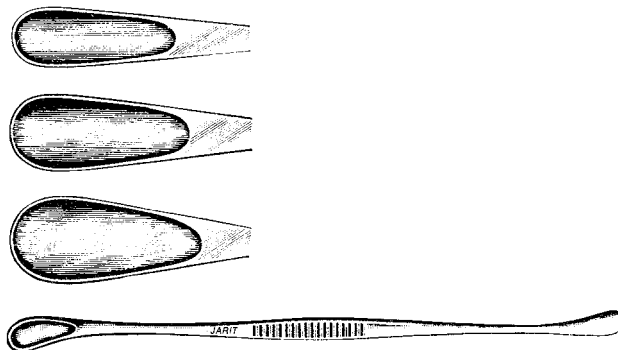

**Desjardin Gall Stone Forceps**

Catalog #	Description
140-175	9¼" (235mm)

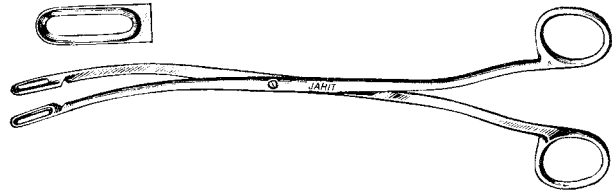

**Blake Gall Stone Forceps**

Catalog #	Description
140-190	8¼" (211mm), straight
140-192	8¼" (211mm), curved

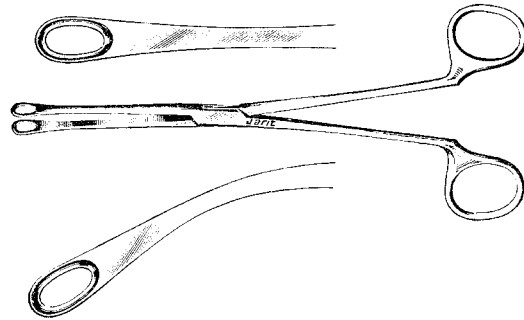

**Lahey Gall Duct Forceps**

Catalog #	Description
140-205	7½" (191mm), curved
140-206	7¾" (195mm), curved, delicate

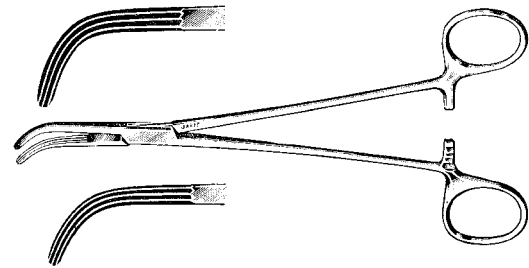

**Lahey Gall Duct Forceps**

Catalog #	Description
140-228	7½" (190mm), cross-serrated tips



**Lower Gall Duct Forceps**

Catalog #	Description
140-210	7¼" (185mm)

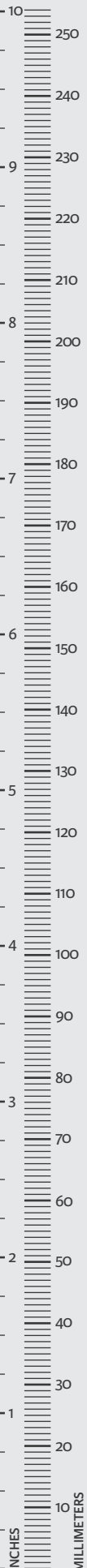
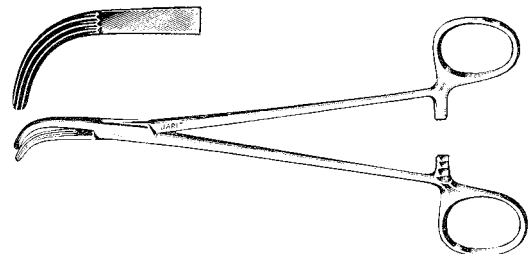

### Mixer Forceps, Pediatric

Catalog #	Description
140-216	5 <sup>3</sup> / <sub>8</sub> " (138mm), curved
140-217	5" (127mm), right angle



### Petit-Point Mixer Forceps

right angle

Catalog #	Description
140-218	5 <sup>3</sup> / <sub>8</sub> " (137mm)

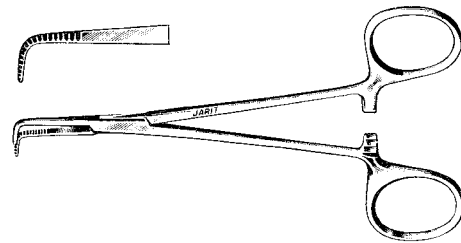

### Petit-Point Mixer Forceps

right angle

Catalog #	Description
140-223	7 <sup>1</sup> / <sub>4</sub> " (185mm)

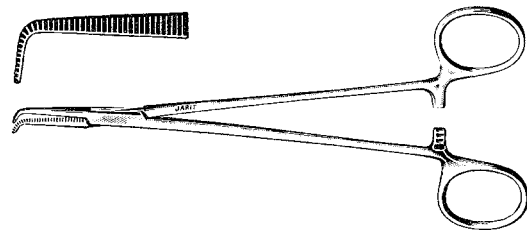

### Mixer Forceps, Full Horizontal Serrations

Catalog #	Description
140-224	6 <sup>1</sup> / <sub>4</sub> " (160mm)
140-225	7" (175mm)

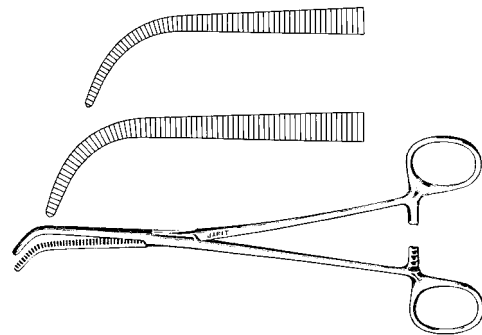

### Mixer Forceps, Partial Horizontal Serrations

Catalog #	Description
140-226	8 <sup>3</sup> / <sub>4</sub> " (224mm)
140-230	9 <sup>1</sup> / <sub>4</sub> " (232mm)

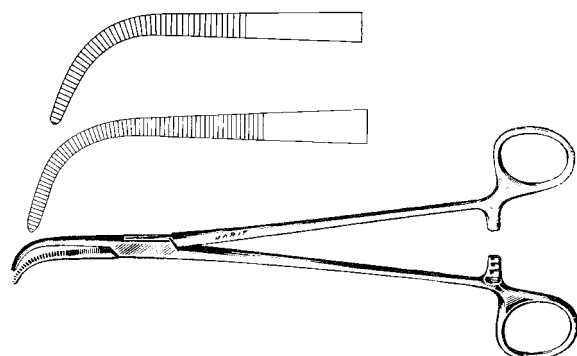

### Meeker Clamp

Catalog #	Description
140-231	7¼" (181mm), right angle

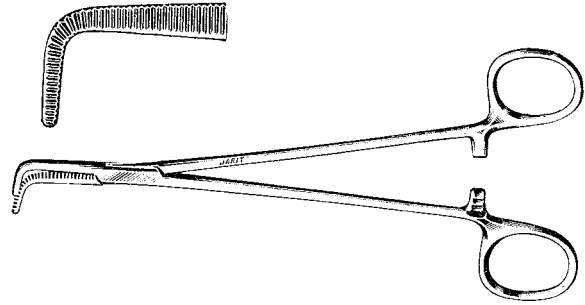

### Diethrich Right Angle Clamps

Catalog #	Description
140-232	4⅞" (124mm)
140-233	5⅜" (138mm)
140-234	7" (180mm)

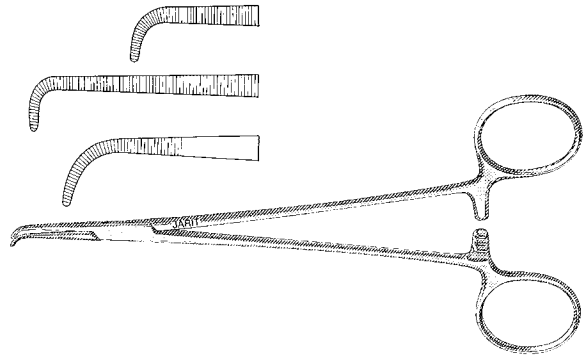

### Varco Gallbladder Forceps

Catalog #	Description
140-240	7½" (192mm), slight curve
140-245	7¾" (197mm), full curve

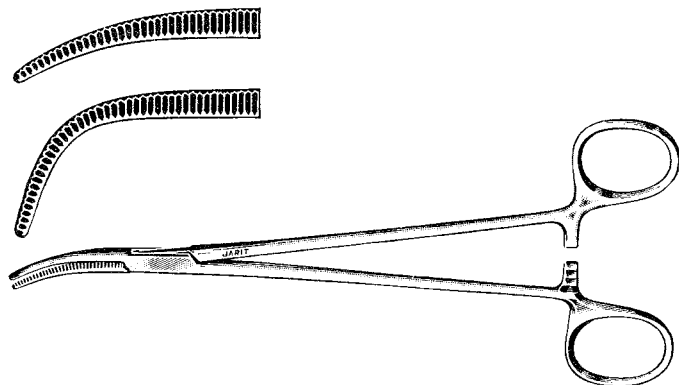

### Thorek Gall Bladder Scissors

Catalog #	Description
140-320	7¼" (185mm), full curve
140-322	9" (230mm), full curve

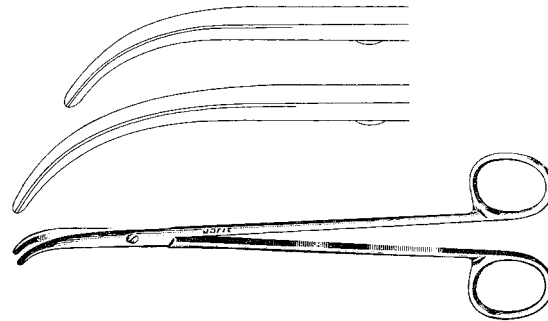

### Gemini Artery Clamps

Catalog #	Description
140-329	5¾" (138mm)
140-330	7½" (190mm)
140-331	8¼" (205mm)
140-332	9" (230mm)
140-333	11" (280mm)
140-335	14¼" (360mm)

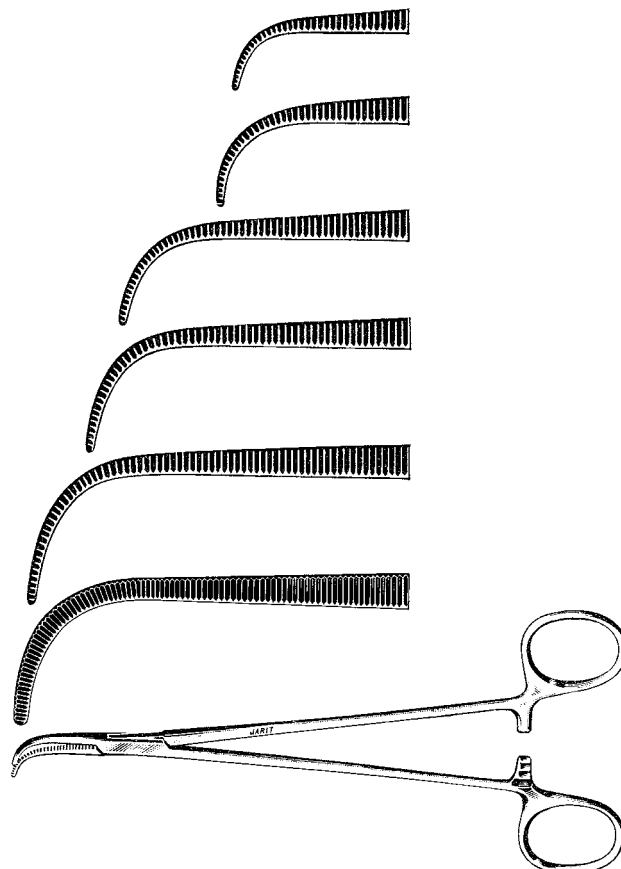

### Lahey Traction Forceps

Catalog #	Description
150-160	6¼" (158mm), 9mm wide, 3 x 3 teeth
150-165	8" (203mm), 9.3mm wide, 3 x 3 teeth

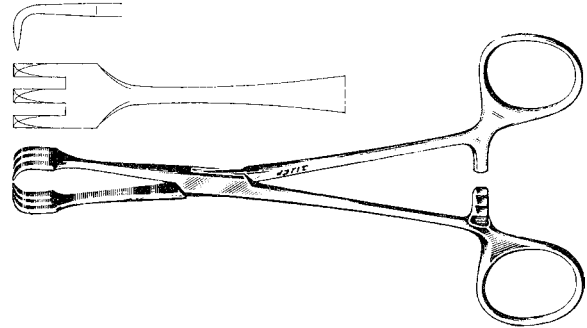

### Lahey Hemostats

Catalog #	Description
150-175	6" (151mm), straight
150-180	6" (151mm), curved

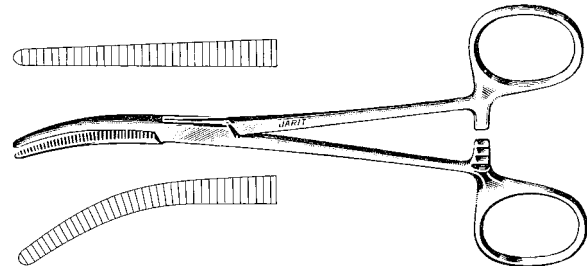

### Mastin Muscle Clamp

curved shanks

Catalog #	Description
150-190	6¾" (167mm), 40mm jaw

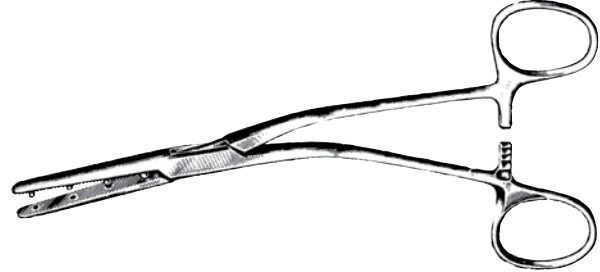

### Nabatoff Vein Stripper

Catalog #	Description
160-120	Complete set in stainless steel sterilizing case

### Replacement Parts

Catalog #	Description
160-HDL-120	T-handle
160-CBL-120	Cable 35"
160-OLV-120-3	3mm olive
160-OLV-120-6	6mm olive
160-OLV-120-9	9mm olive
160-OLV-120-12	12mm olive
160-TIP-120	Tip for suction tube pkg/12ea

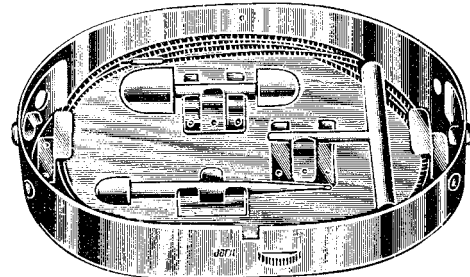
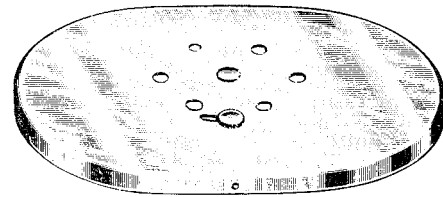



**Poole Suction Tube**

Catalog #	Description
170-100	9¾" (248mm), angular, 26 French

**Poole Suction Tube Parts**

Catalog #	Description
170-ITB-100	Inner tube
170-OTB-100	Outer tube



**Poole Suction Tube**

Catalog #	Description
170-101	7¾" (196mm), pediatric, angular, 17 French, stainless steel

**Poole Suction Tube Parts**

Catalog #	Description
170-ITB-101	Inner tube
170-OTB-101	Outer tube



**Poole Suction Tubes**

straight, 32 French

Catalog #	Description
170-102	9¾" (238mm)
170-103	12" (305mm)
170-104	15" (378mm)



**Poole Suction Tube Parts**

Catalog #	Description
170-ITB-102	Inner tube
170-OTB-102	Outer tube
170-ITB-103	Inner tube

**Poole Abdominal Suction w/Control Valve**

Catalog #	Description
170-105	10½" (269mm), stainless steel



**Andrews-Pyncheon Suction Tube**

Catalog #	Description
170-115	9¼" (234mm)

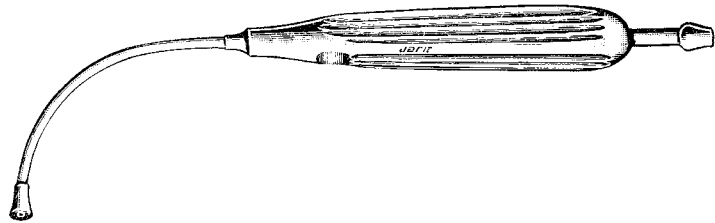

**Yankauer Suction Tube**

Catalog #	Description
170-118	8¼" (208mm), pediatric

**Yankauer Suction Tube Parts**

Catalog #	Description
170-119	Tip for pediatric suction tube pkg/12ea

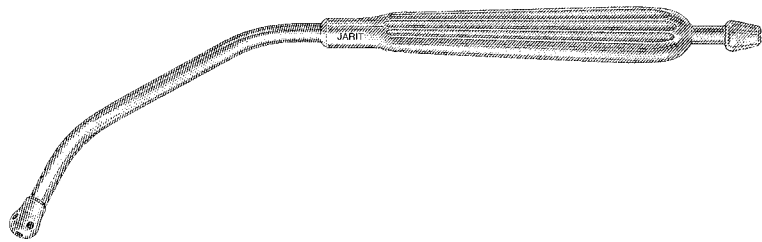

**Yankauer Suction Tube**

Catalog #	Description
170-120	11¼" (284mm)
170-117	15" (378mm)

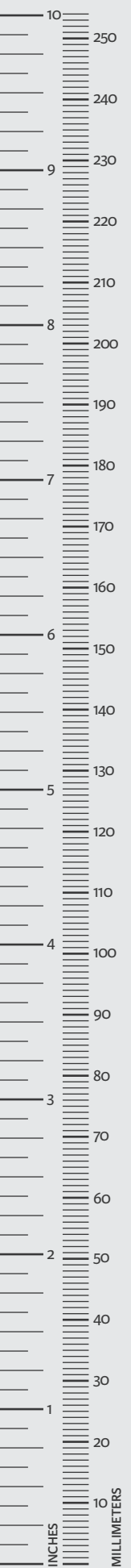
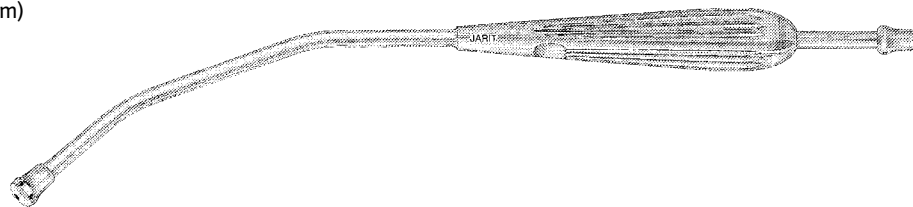

### Yankauer Suction Tube w/Control Valve

Catalog #	Description
170-122	13" (330mm), stainless steel

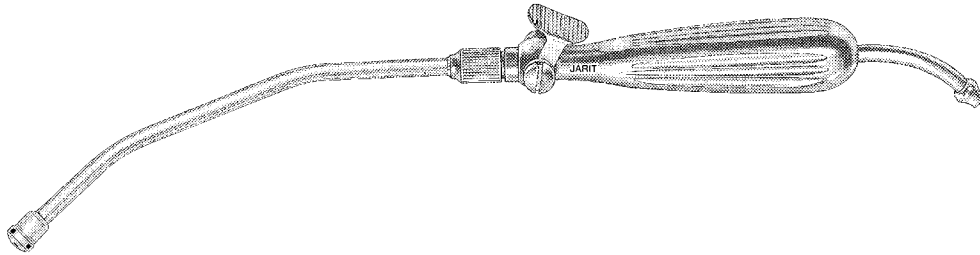

### Coupland Suction Tube

Catalog #	Description
170-125	10" (254mm)

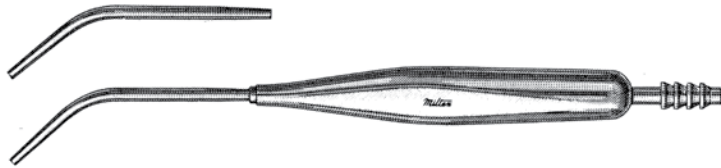

### Catheter Guide (Wire Mandrin)

Catalog #	Description
170-175	18" (460mm), 4 French



### Collins Tongue Seizing Forceps

Catalog #	Description
175-100	6¾" (170mm), small
175-105	7¼" (185mm), large

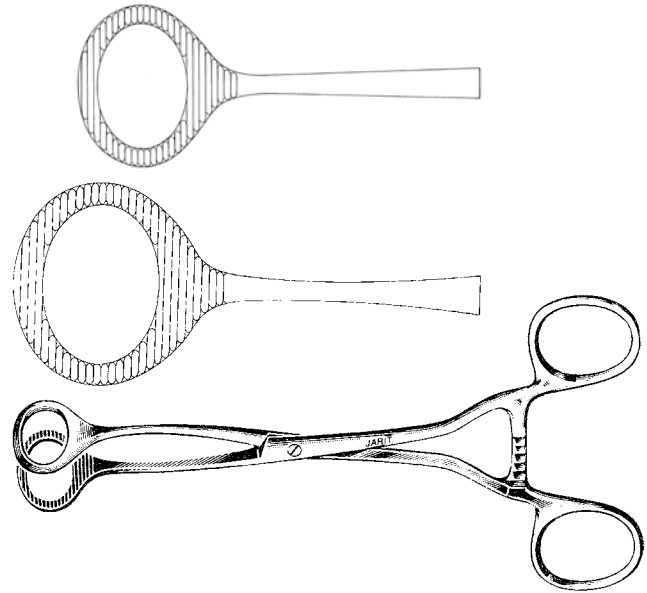

### Young Tongue Seizing Forceps

Catalog #	Description
175-110	5⅞" (150mm)
175-111	Rubber (latex free) jaws only, set of 2

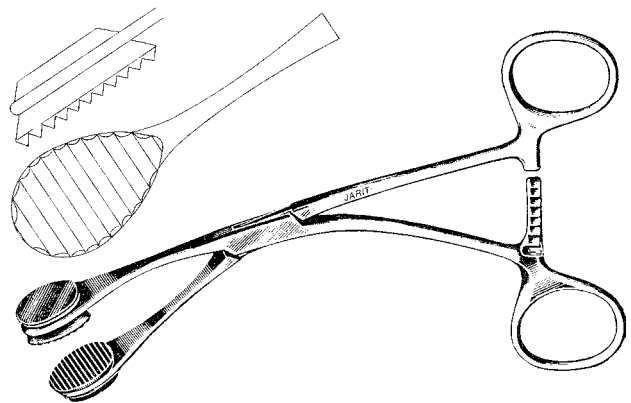

### Magill Catheter Forceps

Catalog #	Description
175-120	9¾" (248mm), adult size
175-121	7¼" (184mm), pediatric size

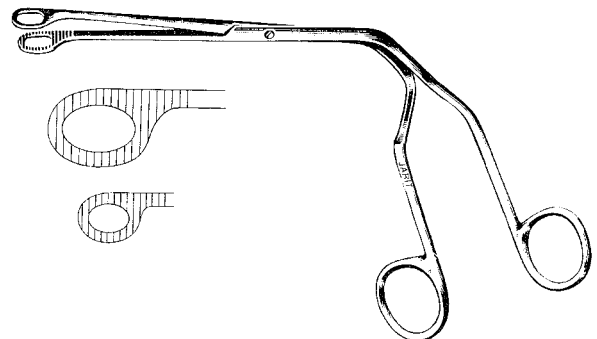

### Taylor Percussion Hammers

solid handle

Catalog #	Description
180-100	7" (180mm), small
180-105	7¾" (196mm), large



\*Rubber inserts are Latex Free

### Rabiner Neurological Hammer

Catalog #	Description
180-110	9¼" (235mm), rubber roller is latex free

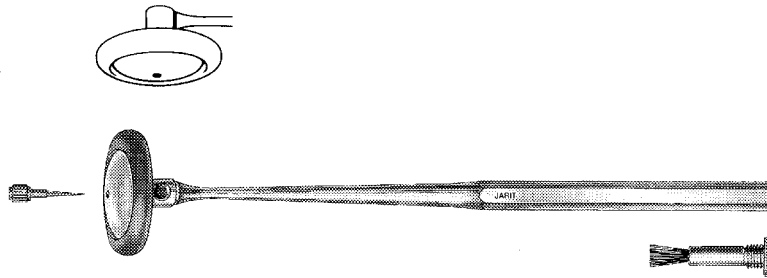

### Buck Neurological Hammer

Catalog #	Description
180-115	7½" (190mm), small, rubber heads are latex free

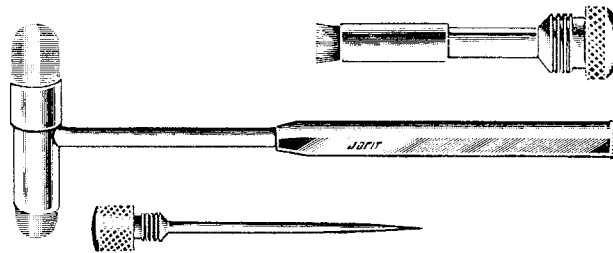

### Wartenberg Pin Wheel

hollow handle

Catalog #	Description
180-130	7¾" (196mm)

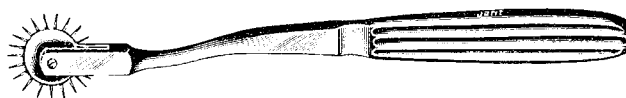

### University of Illinois Bone Marrow Biopsy Needles

Catalog #	Description
180-175	3¾" (95mm), 1" (25mm) cannula, 18 gauge
180-176	3¾" (95mm), 1" (25mm) cannula, 15 gauge

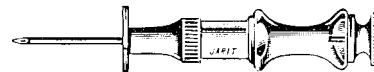

### Laparotomy Rings

Catalog #	Description
180-180	1" (25mm)
180-182	1½" (38mm)
180-184	2" (51mm)
180-188	3" (76mm)

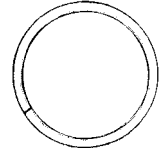

### Probes with Eye, Stainless

Catalog #	Description
180-200	4½" (114mm)
180-201	5" (127mm)
180-202	5½" (140mm)
180-203	6" (152mm)
180-204	7" (178mm)
180-205	8" (203mm)
180-207	10" (254mm)



### Probes, Double Ended, Stainless

Catalog #	Description
180-222	4½" (114mm)
180-223	5" (127mm)
180-224	5½" (140mm)
180-225	6" (152mm)
180-226	7" (178mm)
180-227	8" (203mm)
180-228	10" (254mm)



### Probes with Eye, Silver

Catalog #	Description
180-231	4½" (114mm)
180-232	5" (127mm)
180-233	5½" (140mm)
180-234	6" (152mm)
180-235	7" (178mm)
180-236	8" (203mm)
180-238	10" (254mm)

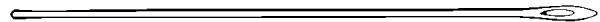

**Grooved Directors**

tongue tie, plain point, stainless

Catalog #	Description
180-250	4½" (114mm)
180-251	5" (127mm)
180-252	5½" (140mm)
180-253	6" (152mm)
180-255	8" (203mm)



**Grooved Directors**

tongue tie, probe point, stainless

Catalog #	Description
180-260	4½" (114mm)
180-261	5" (127mm)
180-262	5½" (140mm)
180-263	6" (152mm)
180-265	8" (203mm)



**Saalfeld Comedone Extractor**

Catalog #	Description
185-100	4 1/4" (108mm)

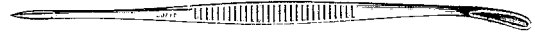

**Saalfeld Comedone Extractor**

Catalog #	Description
185-105	5 7/8" (150mm)



**Schamberg Comedone Extractor**

Catalog #	Description
185-110	3 3/4" (96mm)



**Unna Comedone Extractor**

Catalog #	Description
185-115	5 3/4" (146mm)



**Comedone Extractor**

Catalog #	Description
185-120	6 1/4" (157mm)



**Finger Ring Cutter**

Catalog #	Description
185-135	6 1/4" (160mm)
185-136	Replacement blade only
185-WSR-135	Replacement washer set

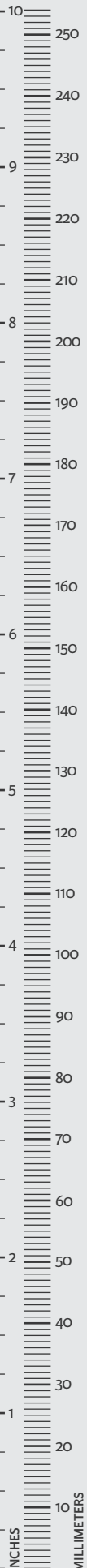
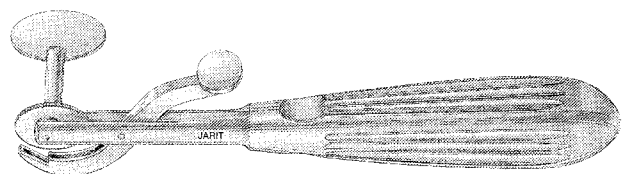



### Keys Dermal Punch Set

Catalog #	Description
185-150	Set includes: 6 tips, 1 handle on instrument holder
185-152	2mm replacement head
185-153	3mm replacement head
185-154	4mm replacement head
185-155	5mm replacement head
185-156	6mm replacement head
185-157	7mm replacement head
185-HDL-150	Handle only

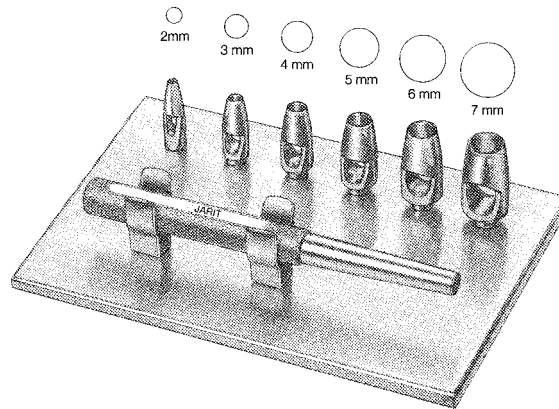

### Keys Dermal Punches

Catalog #	Description
185-170	3 <sup>7</sup> / <sub>8</sub> " (100mm), 2mm
185-171	3 <sup>7</sup> / <sub>8</sub> " (100mm), 3mm
185-172	3 <sup>7</sup> / <sub>8</sub> " (100mm), 4mm
185-176	3 <sup>7</sup> / <sub>8</sub> " (100mm), 5mm
185-173	3 <sup>7</sup> / <sub>8</sub> " (100mm), 6mm
185-174	3 <sup>7</sup> / <sub>8</sub> " (100mm), 8mm
185-175	3 <sup>7</sup> / <sub>8</sub> " (100mm), 10mm



### Fox Dermal Currettes

Catalog #	Description
185-179	5 <sup>5</sup> / <sub>8</sub> " (142mm), 2mm
185-180	5 <sup>5</sup> / <sub>8</sub> " (142mm), 3mm
185-181	5 <sup>5</sup> / <sub>8</sub> " (142mm), 4mm
185-182	5 <sup>5</sup> / <sub>8</sub> " (142mm), 5mm
185-183	5 <sup>5</sup> / <sub>8</sub> " (142mm), 6mm

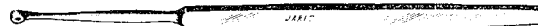

### Piffard Dermal Currettes

Catalog #	Description
185-185	6 <sup>1</sup> / <sub>4</sub> " (160mm), 4mm
185-186	6 <sup>1</sup> / <sub>4</sub> " (160mm), 5mm
185-187	6 <sup>1</sup> / <sub>4</sub> " (160mm), 6mm

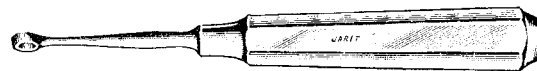

### Nail Nippers

Catalog #	Description
185-191	4 <sup>1</sup> / <sub>2</sub> " (114mm), concave, stainless steel
185-193	5 <sup>1</sup> / <sub>2</sub> " (130mm), concave, stainless steel

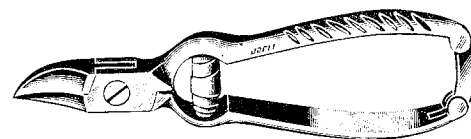

**Nail Nippers**

5" (127mm), straight

Catalog #	Description
185-196	Stainless steel

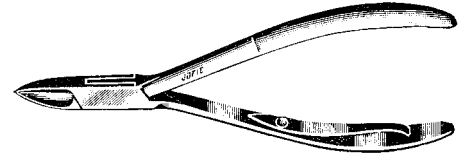

**Nail Nippers**

5½" (140mm), concave

Catalog #	Description
185-201	Stainless steel

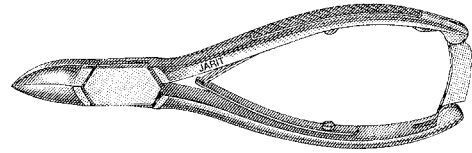

**Nail Nippers**

5½" (140mm), angled concave

Catalog #	Description
185-206	Stainless steel

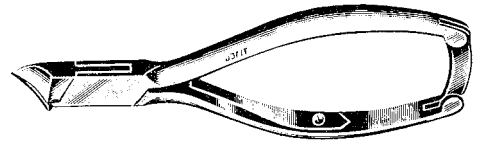

**Nail Splitter, English Anvill Pattern**

Catalog #	Description
185-210	5" (127mm), double spring (stainless)

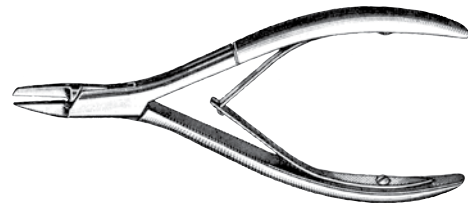

**Cuticle Nippers**

3¾" (100mm), convex

Catalog #	Description
185-231	Stainless steel

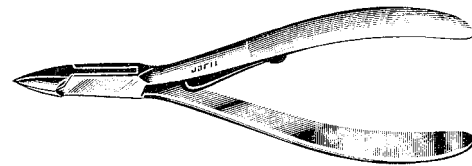

**Cuticle Scissors**

Catalog #	Description
185-250	3½" (88mm), curved

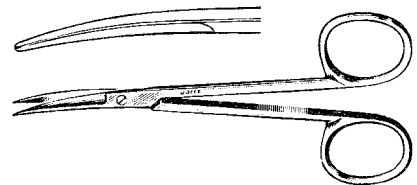

**Nail Scissors**

Catalog #	Description
185-260	3¾" (95mm), heavy

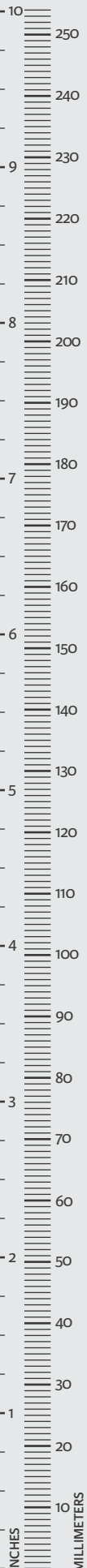
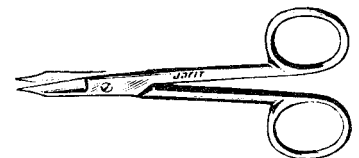

**Flexible Shaft Retractors**

5 7/8" (150mm)

Catalog #	Description
190-100	1 prong, sharp
190-101	2 prong, sharp, 4.2mm wide
190-102	3 prong, sharp, 8mm wide
190-103	1 prong, blunt
190-104	2 prongs, blunt, 4.2mm wide
190-105	3 prongs, blunt, 8mm wide

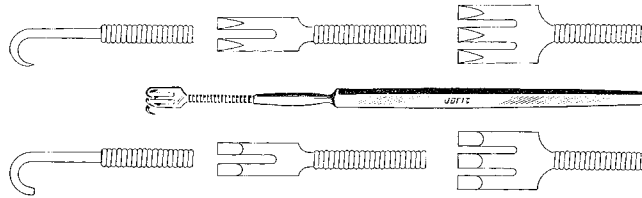

**Senn Retractors, (Satin Finish)**

double-ended, 8mm wide, solid blade 3/4" x 1/4" (19mm x 6.3mm)

Manufactured from high grade German surgical stainless steel which is ground and polished to a satin finish

Catalog #	Description
190-110	6 1/4" (160mm), 3-prong, sharp
190-112	6 1/4" (160mm), 3-prong, blunt

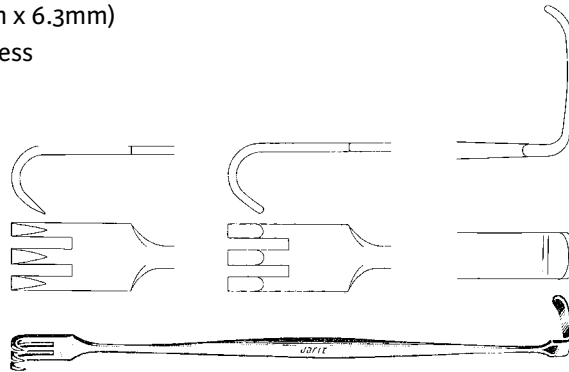

**Senn Retractors, (Matte Finish)**

double-ended, 8mm wide, solid blade 3/4" x 1/4" (19mm x 6.3mm)

Manufactured from high grade German surgical stainless steel which is glass beaded to a matte finish

Catalog #	Description
189-110	6 1/4" (160mm), 3-prong, sharp
189-112	6 1/4" (160mm), 3-prong, blunt

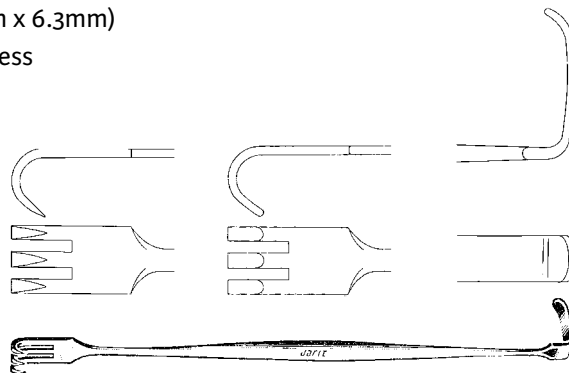

**Mathieu Retractors**

double-ended, 8mm wide, solid blade 3/4" x 1/4" (19mm x 6.3mm)

Catalog #	Description
190-115	6 1/4" (160mm), 3 sharp prongs
190-116	6 1/4" (160mm), 3 blunt prongs

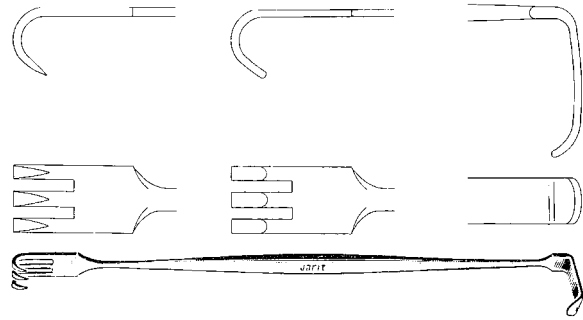

**Rollet Retractor**

Catalog #	Description
190-118	5 1/4" (132mm), 4 sharp prongs, 6mm wide

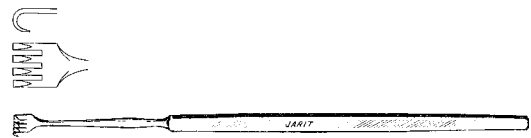

**Knapp Retractor**

Catalog #	Description
190-120	5 1/4" (132mm), 4 blunt prongs, 6mm wide

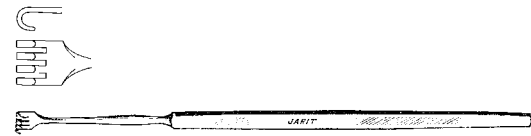

**Miller Retractor**

5 1/4" (133mm), 9-prong, 16mm wide

Catalog #	Description
410-225	Blunt
410-226	Sharp

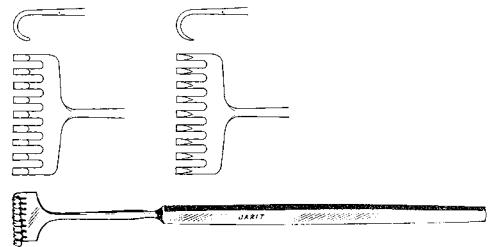

**Meyerding Skin Hook and Retractor**

Catalog #	Description
190-129	6" (155mm), solid blade 5/8" x 3/16" wide (16mm x 5mm)

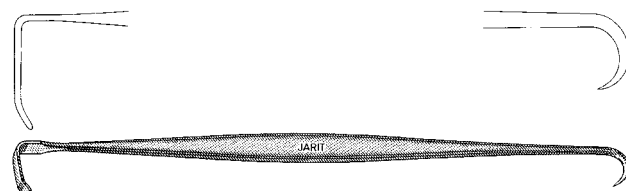

### House Hand Retractor

Catalog #	Description
385-270	6" (152mm), double-ended, 6.5mm x 20mm and 9mm x 25mm blades

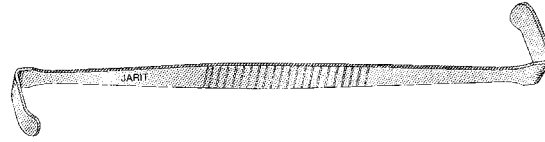

### Ragnell Retractor

Catalog #	Description
410-220	6" (152mm), double-ended Small blade 2.85mm x 8.2mm Large blade 5.6mm x 14.5mm

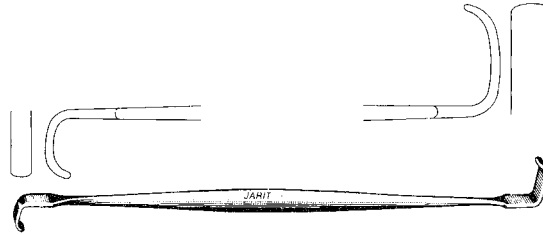

### Davis Retractor

Catalog #	Description
410-230	5¾" (145mm), double-ended Small blade 5.8mm x 20mm Large blade 8.25mm x 25mm

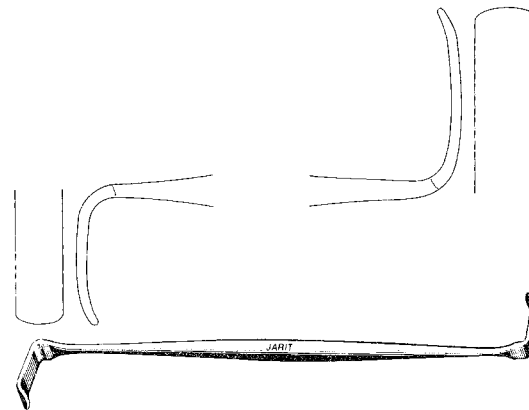

### Meyerding Finger Retractors

7" (175mm)

Catalog #	Description
190-130	Style 1, 13/16" x 9/32" wide (21mm x 7.1mm)
190-131	Style 2, 5/8" x 3/16" wide (16mm x 5mm)
190-132	Style 3, 1/4" x 5/32" wide (6.3mm x 4mm)
190-133	Style 4, 3/8" x 1/8" wide (10mm x 3.2mm)
190-134	Style 5, 5/16" x 5/32" wide (8mm x 4mm)
190-135	Style 6, 1/4" x 5/16" wide (6.3mm x 8mm)

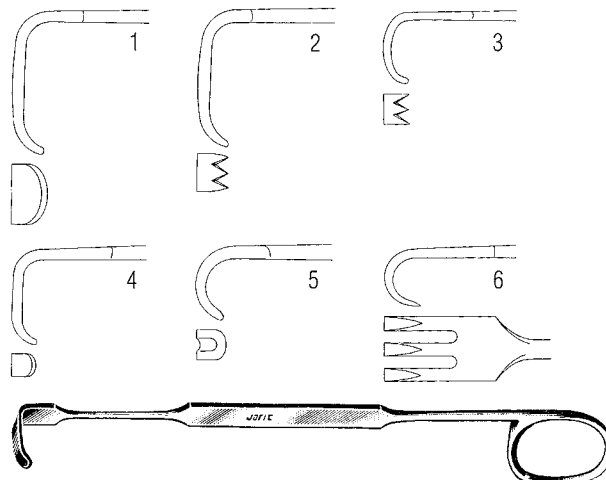

**Finger Rake Retractors**

6½" (165mm)

Catalog #	Description
190-150	1 prong, sharp
190-151	2 prongs, sharp, 5mm wide
190-152	3 prongs, sharp, 9mm wide
190-153	4 prongs, sharp, 12mm wide
190-154	1 prong, blunt
190-155	2 prongs, blunt, 5mm wide
190-156	3 prongs, blunt, 9mm wide
190-157	4 prongs, blunt, 12mm wide

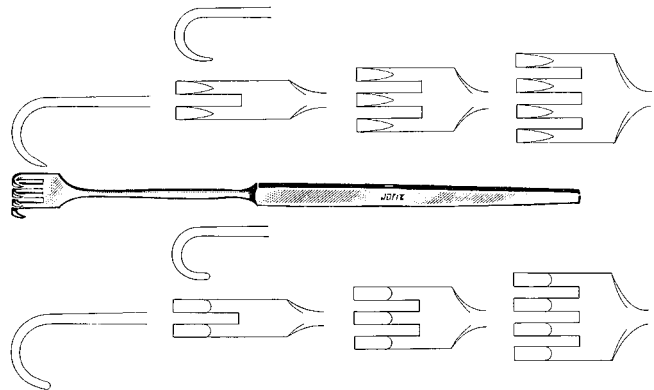

**Volkman Retractors**

4⅝" (118mm)

Catalog #	Description
190-170	2 prongs, sharp, 7.6mm wide
190-171	3 prongs, sharp, 9.15mm wide
190-172	4 prongs, sharp, 12.15mm wide
190-173	6 prongs, sharp, 19mm wide
190-175	2 prongs, blunt, 7.6mm wide
190-176	3 prongs, blunt, 9.15mm wide
190-177	4 prongs, blunt, 12.15mm wide
190-178	6 prongs, blunt, 19mm wide

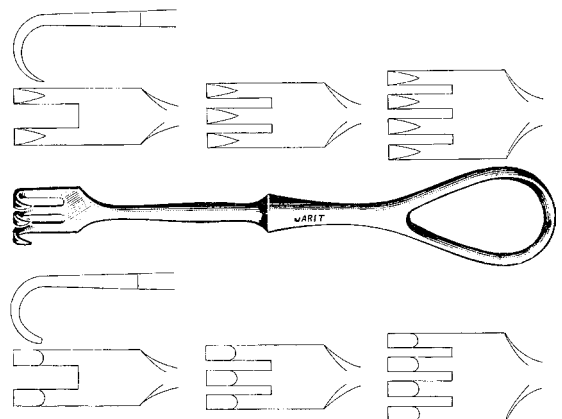

### Mayo-Collins Retractor

Catalog #	Description
200-100	6" (152mm), double-ended, set of 2, blades $\frac{3}{4}$ " x $1\frac{1}{4}$ " deep and $\frac{3}{4}$ " x $1\frac{3}{8}$ " deep (18mm x 32mm and 19mm x 35mm)

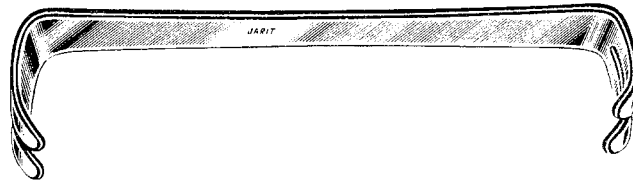

### U.S. Army Retractor, (Satin Finish)

8 $\frac{1}{4}$ " (210mm), double-ended, blades  $\frac{5}{8}$ " (15mm) wide, set of 2  
Manufactured from high grade German surgical stainless steel which is ground and polished to a satin finish

Catalog #	Description
200-105	small blade: $1\frac{1}{8}$ " x $1\frac{3}{4}$ " (28mm x 44mm) large blade: $1\frac{3}{16}$ " x $1\frac{7}{8}$ " (30mm x 47mm)



### U.S. Army Retractor, (Matte Finish)

8 $\frac{1}{4}$ " (210mm), double-ended, blades  $\frac{5}{8}$ " (15mm) wide, set of 2  
Manufactured from high grade German surgical stainless steel which is glass beaded to a matte finish

Catalog #	Description
199-105	small blade: $1\frac{1}{8}$ " x $1\frac{3}{4}$ " (28mm x 44mm) large blade: $1\frac{3}{16}$ " x $1\frac{7}{8}$ " (30mm x 47mm)



### Roux Retractors

double-ended

Catalog #	Description
200-106	Set of 3
200-107	5 $\frac{1}{2}$ " (140mm), small: $\frac{7}{8}$ " x $1\frac{1}{8}$ " (21mm x 30mm) blades
200-108	6" (155mm), medium: 1" x $1\frac{1}{2}$ " (26mm x 37mm) blades
200-109	6 $\frac{1}{2}$ " (165mm), large: $1\frac{1}{8}$ " x $1\frac{5}{8}$ " (29mm x 42mm) blades

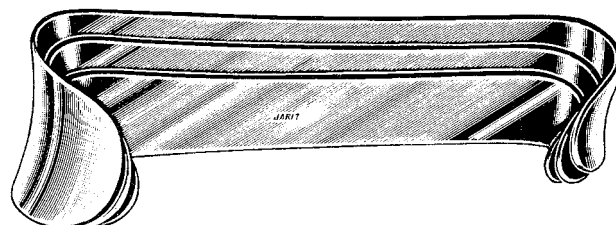

**Farabeuf Retractor**

Catalog #	Description
200-110	4¾" (121mm), double-ended, set of 2: small blade ¾" x 1⅛" (10mm x 27mm) deep, large blade ½" x 1⅜" (13mm x 35mm) deep

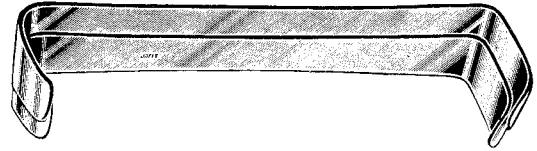

**Farabeuf Retractor**

Catalog #	Description
200-115	5⅞" (149mm), double-ended, set of 2: small blade ⅝" x 1" (16mm x 25mm) deep, large blade ⅝" x ¼" (16mm x 32mm) deep

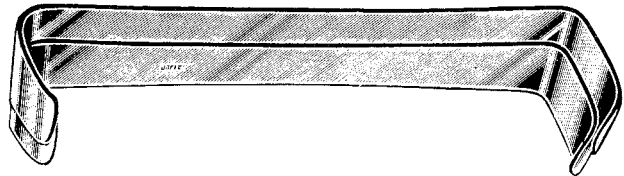

**Sistrunk Retractor**

Catalog #	Description
200-119	6" (153mm), double-ended, blade ⅜" x 1" (10mm x 25mm) deep



**Parker Retractor**

Catalog #	Description
200-120	5½" (140mm), double-ended, set of 2, blades ⅝" x 1" (16mm x 25mm) deep

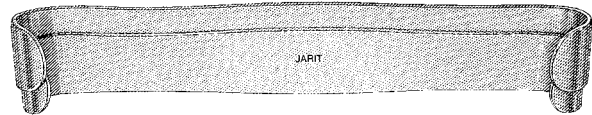

**Parker Retractor**

Catalog #	Description
200-122	7" (180mm), double-ended, set of 2, blades 1" x 1¼" (25mm x 31.5mm) deep

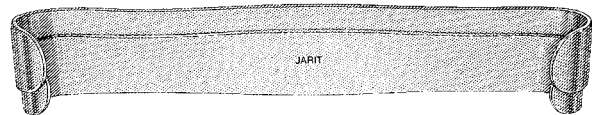

**Parker-Mott Retractor**

Catalog #	Description
200-125	5¾" (145mm), double-ended, set of 2, blades 1" x 2½" (25mm x 62mm) deep

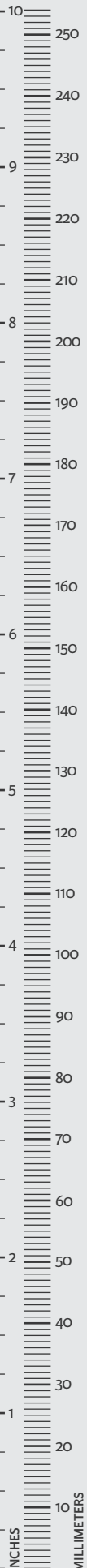
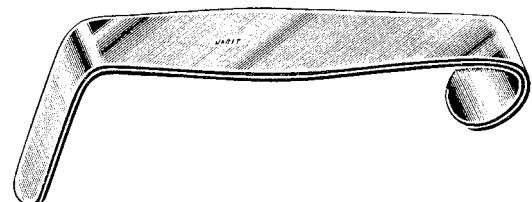



### Langenbeck Retractor

Catalog #	Description
200-126	8½" (216mm), Small blade: ¾" x 1¾" (10mm x 46mm) deep
200-127	8½" (216mm), Medium blade: ½" x 1¾" (13mm x 46mm) deep
200-128	8½" (216mm), Large blade: ⅝" x 1¾" (16mm x 46mm) deep



### Goelet Retractor

Catalog #	Description
200-130	7½" (190mm), double-ended, Blades: small end 1¼" and 1⅝" wide (31mm x 40mm), large end 1½" x 1⅝" (37mm x 40mm)

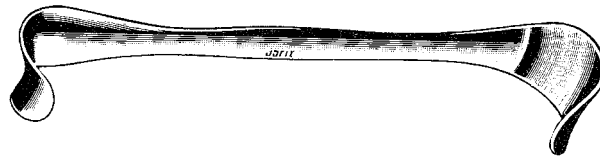

### McBurney Thyroid Retractor

Catalog #	Description
200-131	7½" (190mm), blade ⅝" x ⅜" wide (16mm x 10mm)



### Green Thyroid Retractor

Catalog #	Description
200-132	8¾" (223mm), blade 1" x ¾" wide (25mm x 17.5mm)



### Little Retractor

Catalog #	Description
200-133	7½" (190mm), blade ⅝" x ½" wide (16mm x 12mm)



### Lahey Thyroid Retractor

Catalog #	Description
200-134	7 <sup>3</sup> / <sub>4</sub> " (200mm), blade 1 <sup>1</sup> / <sub>8</sub> " x 1 <sup>1</sup> / <sub>4</sub> " wide (29mm x 7mm)

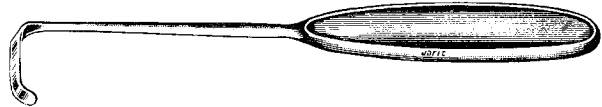

### Cushing Vein Retractor, (Satin Finish)

blade 1/2" x 7/16" (13mm x 11.4mm)

Manufactured from high grade German surgical stainless steel which is ground and polished to a satin finish

Catalog #	Description
200-135	9" (230mm)
200-136	11" (279mm)
200-137	14" (356mm)



### Cushing Vein Retractor, (Matte Finish)

blade 1/2" x 7/16" (13mm x 11.4mm)

Manufactured from high grade German surgical stainless steel which is glass beaded to a matte finish

Catalog #	Description
199-135	9" (230mm)



### Crile Retractor

Catalog #	Description
200-138	4 <sup>1</sup> / <sub>4</sub> " (109mm), double-ended, Small blade: 1/2" x 3/16" (14mm x 4.5mm) Large blade: 7/8" x 1/4" (21.8mm x 6.8mm)



### Sauerbruch Retractors

Catalog #	Description
200-140	8¾" (225mm), blade 2⅛" x ⅝" (53mm x 17mm)
200-142	8¾" (225mm), blade 2¾" x ⅞" (70mm x 23mm)
200-143	8¾" (225mm), blade 3" x ¾" (77mm x 20mm)



### Doyen Retractors

Catalog #	Description
200-145	8⅞" (225mm), blade 1¾" x 2½" (45mm x 65mm)
200-147	8⅞" (225mm), blade 2⅛" x 3" (55mm x 75mm)
200-149	8⅞" (225mm), blade 2¼" x 3½" (55mm x 90mm)

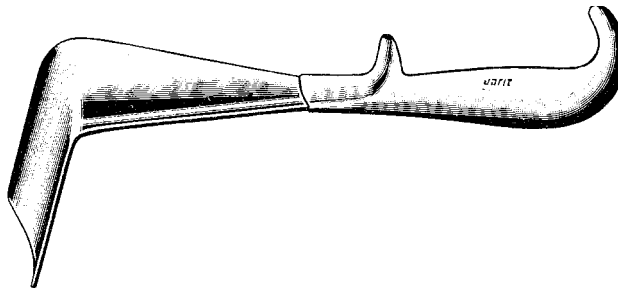

### Richardson-Eastman Retractors

double-ended

Catalog #	Description
200-150	Set of 2
200-151	10" (252mm), small blade ⅞" x 1⅛" (22mm x 29mm), large blade 1⅛" x 1⅜" (30mm x 35mm)
200-152	10⅝" (270mm), small blade 1½" x 1¾" (37mm x 46mm), large blade 1¾" x 2¾" (43mm x 71mm)

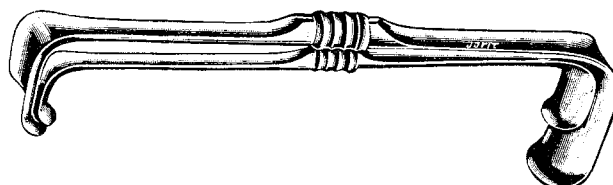

**Richardson Retractors**

lamb handle

Catalog #	Description
200-155	10 <sup>3</sup> / <sub>4</sub> " (270mm), blade 7 <sup>7</sup> / <sub>8</sub> " x 7 <sup>7</sup> / <sub>8</sub> " (22mm x 23mm)
200-156	10 <sup>3</sup> / <sub>4</sub> " (270mm), blade 1" wide x 1 <sup>1</sup> / <sub>4</sub> " deep (25mm x 32mm)
200-157	10 <sup>3</sup> / <sub>4</sub> " (270mm), blade 1 <sup>1</sup> / <sub>2</sub> " wide x 1 <sup>1</sup> / <sub>2</sub> " deep (38mm x 38mm)

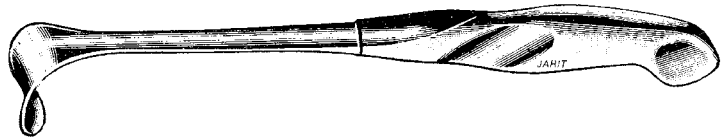

**Richardson Retractors**

hollow grip handle

Catalog #	Description
201-155	9 <sup>3</sup> / <sub>4</sub> " (245mm), blade 3 <sup>3</sup> / <sub>4</sub> " x 1 <sup>1</sup> / <sub>8</sub> " (20mm x 28mm)
201-156	9 <sup>3</sup> / <sub>4</sub> " (245mm), blade 1 <sup>1</sup> / <sub>8</sub> " x 1 <sup>3</sup> / <sub>8</sub> " (27mm x 34mm)
201-157	9 <sup>3</sup> / <sub>4</sub> " (245mm), blade 1 <sup>1</sup> / <sub>2</sub> " x 1 <sup>5</sup> / <sub>8</sub> " (37mm x 40mm)

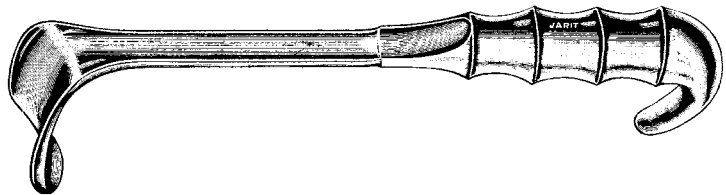

**Richardson Retractors**

loop handle

Catalog #	Description
202-155	9 <sup>1</sup> / <sub>2</sub> " (241mm), blade 7 <sup>7</sup> / <sub>8</sub> " x 1 <sup>1</sup> / <sub>8</sub> " (22mm x 27mm)
202-156	9 <sup>1</sup> / <sub>2</sub> " (241mm), blade 1 <sup>1</sup> / <sub>8</sub> " x 1 <sup>3</sup> / <sub>8</sub> " (30mm x 35mm)
202-157	9 <sup>1</sup> / <sub>2</sub> " (241mm), blade 1 <sup>1</sup> / <sub>2</sub> " x 1 <sup>5</sup> / <sub>8</sub> " (38mm x 42mm)

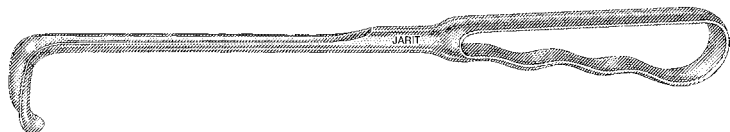

**Richardson Appendectomy Retractor**

lamb handle

Catalog #	Description
200-160	10 <sup>3</sup> / <sub>4</sub> " (270mm), blade <sup>3</sup> / <sub>4</sub> " wide x 2" deep (19mm x 51mm)

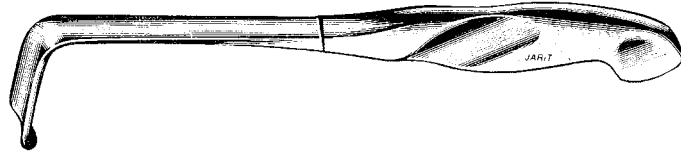

**Richardson Appendectomy Retractor**

hollow grip handle

Catalog #	Description
201-160	9 <sup>3</sup> / <sub>4</sub> " (245mm), blade <sup>3</sup> / <sub>4</sub> " wide x 2" deep (22mm x 52mm)

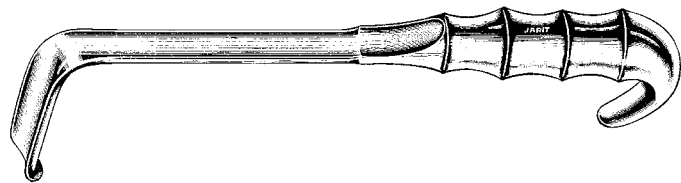

**Richardson Appendectomy Retractor**

loop handle

Catalog #	Description
202-160	9 <sup>1</sup> / <sub>2</sub> " (240mm), blade <sup>3</sup> / <sub>4</sub> " wide x 2" deep (22mm x 52mm)

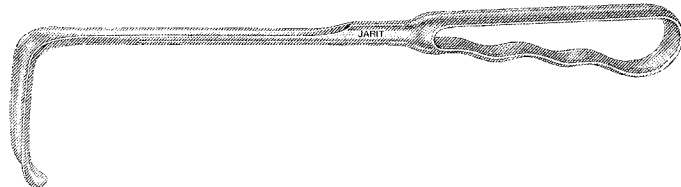

**Murphy Gall Bladder Retractor**

Catalog #	Description
475-429	10" (254mm), blade 2" wide (50mm)

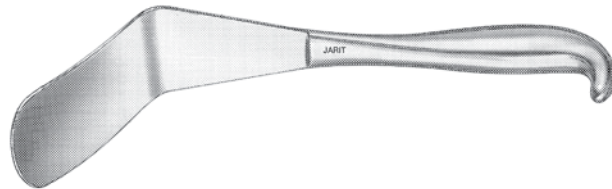

**Semb Retractor**

Catalog #	Description
200-261	9 <sup>3</sup> / <sub>4</sub> " (248mm), small blade <sup>3</sup> / <sub>4</sub> " x 1 <sup>3</sup> / <sub>4</sub> " (18mm x 43mm)



**Kelly Retractors**

lamb handle

Catalog #	Description
200-165	10 <sup>3</sup> / <sub>4</sub> " (270mm), blade 1 <sup>1</sup> / <sub>2</sub> " x 2" deep (38mm x 51mm)
200-166	11" (280mm), blade 2" x 2 <sup>1</sup> / <sub>2</sub> " deep (51mm x 64mm)
200-167	11" (280mm), blade 2 <sup>1</sup> / <sub>2</sub> " x 3" deep (64mm x 76mm)
200-168	11 <sup>1</sup> / <sub>2</sub> " (290mm), blade 3" x 3 <sup>1</sup> / <sub>2</sub> " deep (76mm x 89mm)

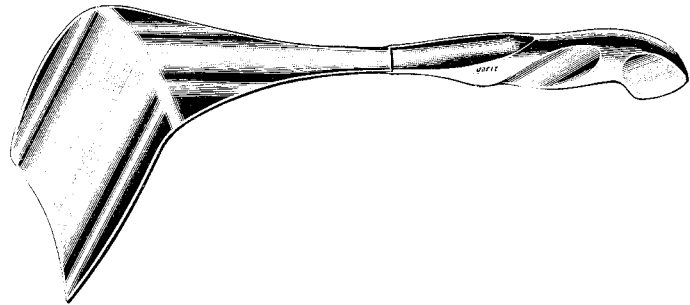

**Kelly Retractors**

hollow grip handle

Catalog #	Description
201-165	9 <sup>1</sup> / <sub>2</sub> " (244mm), blade 1 <sup>1</sup> / <sub>2</sub> " x 2" deep (40mm x 54mm)
201-166	10" (254mm), blade 2" x 2 <sup>1</sup> / <sub>2</sub> " deep (53mm x 65mm)
201-167	10" (254mm), blade 2 <sup>1</sup> / <sub>2</sub> " x 3" deep (65mm x 81mm)
201-168	10 <sup>1</sup> / <sub>2</sub> " (266mm), blade 3" x 3 <sup>1</sup> / <sub>2</sub> " deep (76mm x 100mm)

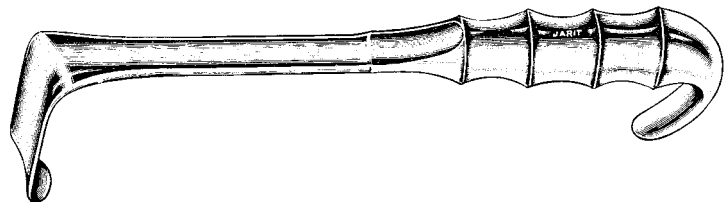

**Kelly Retractors**

loop handle

Catalog #	Description
202-165	9 <sup>1</sup> / <sub>4</sub> " (238mm), blade 1 <sup>1</sup> / <sub>2</sub> " x 2" deep (42mm x 55mm)
202-166	9 <sup>3</sup> / <sub>4</sub> " (246mm), blade 2" x 2 <sup>1</sup> / <sub>2</sub> " deep (51mm x 66mm)
202-167	10 <sup>1</sup> / <sub>2</sub> " (266mm), blade 2 <sup>1</sup> / <sub>2</sub> " x 3" deep (65mm x 80mm)
202-168	10 <sup>3</sup> / <sub>4</sub> " (275mm), blade 3" x 3 <sup>1</sup> / <sub>2</sub> " deep (76mm x 102mm)

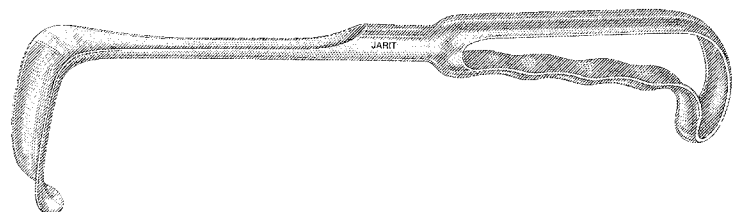

### Mayo Abdominal Retractor

Lamb handle

Catalog #	Description
200-170	10 <sup>3</sup> / <sub>4</sub> " (275mm), blade 2 <sup>3</sup> / <sub>4</sub> " wide (70mm)

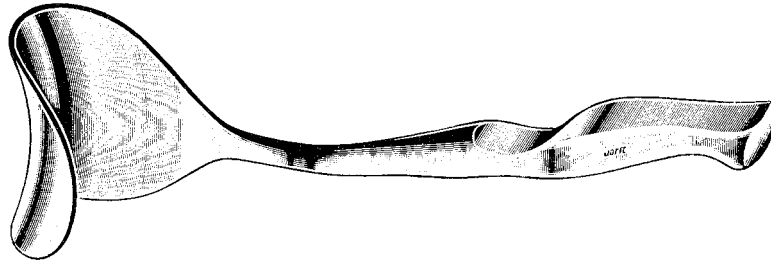

### Hibbs Retractors

Catalog #	Description
200-172	9 <sup>1</sup> / <sub>2</sub> " (242mm), blade 1" x 3" deep (26mm x 76mm)
200-173	9 <sup>1</sup> / <sub>4</sub> " (235mm), blade <sup>3</sup> / <sub>4</sub> " x 2 <sup>1</sup> / <sub>4</sub> " deep (19mm x 56mm)



### Harrington Splanchnic Retractors

Lamb handle

Catalog #	Description
200-175	12 <sup>1</sup> / <sub>2</sub> " (318mm), blade 1 <sup>3</sup> / <sub>4</sub> " wide (44mm)
200-176	12 <sup>1</sup> / <sub>2</sub> " (318mm), blade 2 <sup>5</sup> / <sub>8</sub> " wide (66mm)

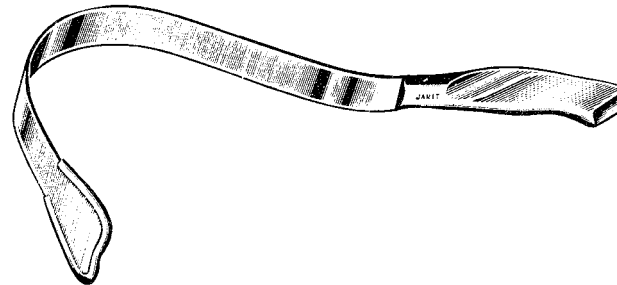

### Harrington-Pemberton Retractors

Catalog #	Description
200-178	12" (305mm), blade 2 <sup>3</sup> / <sub>8</sub> " wide (60mm)

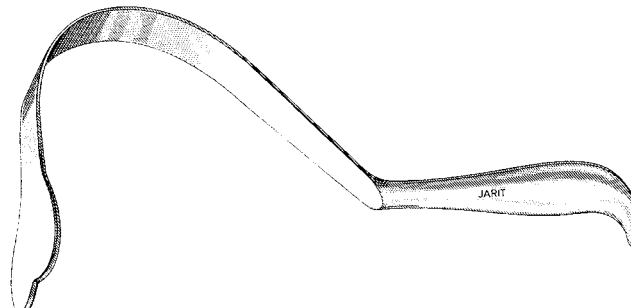

**Ford-Deaver Retractors**

lamb handle, 16½" (420mm), blade 10" x 6" deep (254mm x 152mm)

Catalog #	Description
200-180	2" wide (50mm)
200-181	3" wide (75mm)
200-182	4" wide (100mm)

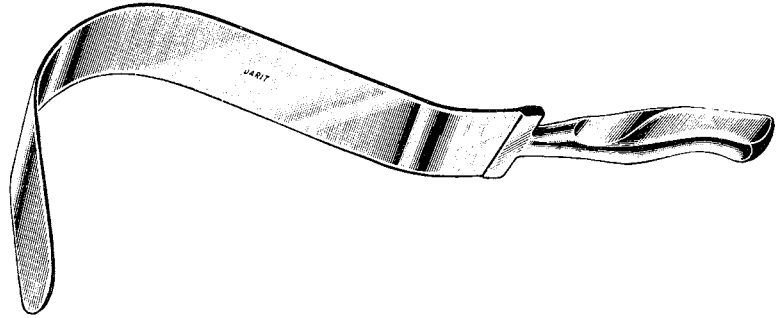

**Meyerding Retractors**

Catalog #	Description
200-190	8" (205mm), blade 5/8" x 2" deep (16mm x 53mm)
200-191	8¾" (225mm), blade 1" x 3" deep (25mm x 76mm)
200-192	9¾" (250mm), blade 2" x 3½" deep (50mm x 90mm)

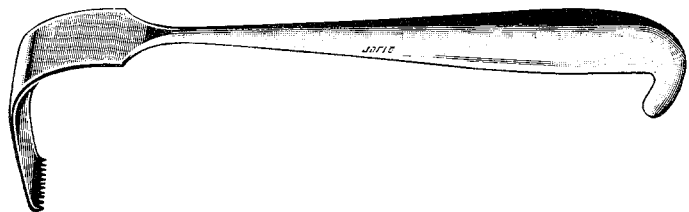

**Deaver Pediatric Retractors**

double-ended, pediatric sizes

Catalog #	Description
200-194	6¾" (172mm), blade 8mm wide
200-195	6¾" (172mm), blade 10mm wide
200-196	6¾" (172mm), blade 13mm wide
200-197	Set of 3

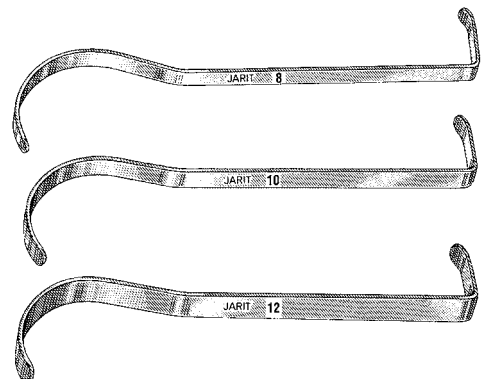



**Deaver Retractor**

Catalog #	Description
200-198	3/8" wide x 7 1/4" long (9.6mm x 182mm), pediatric size

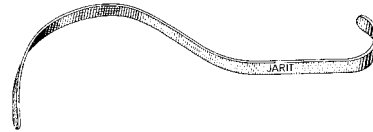

**Deaver Retractor**

Catalog #	Description
200-200	3/4" wide x 7" long (19mm x 178mm)

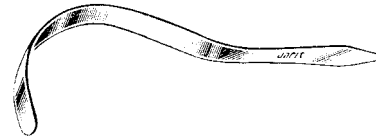

**Deaver Retractor**

Catalog #	Description
200-201	7/8" wide x 8 1/2" long (22mm x 216mm)

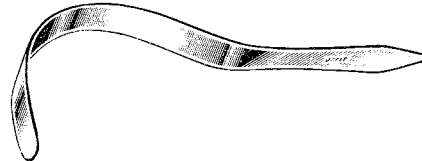

**Deaver Retractors**

Catalog #	Description
200-208	1" wide x 10 1/2" long (25mm x 265mm)
200-202	1" wide x 12" long (25mm x 305mm)
200-203	1" wide x 13" long (25mm x 330mm)
200-204	1" wide x 14" long (25mm x 356mm)

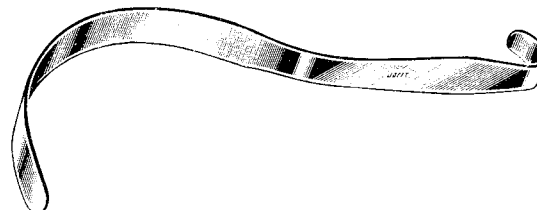

**Deaver Retractors**

Catalog #	Description
200-205	1½" wide x 12" long (38mm x 305mm)
200-206	2" wide x 12" long (50mm x 305mm)

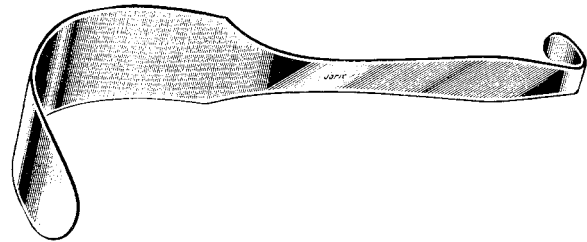

**Deaver Retractor**

Catalog #	Description
200-207	3" wide x 12" long (76mm x 305mm)

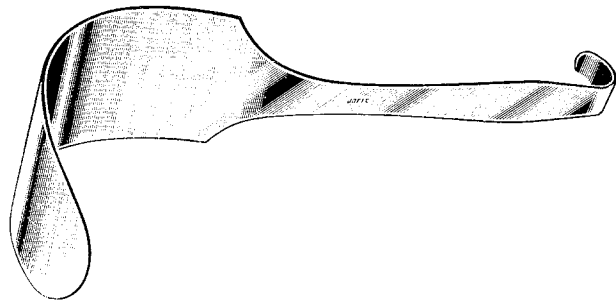

**Deaver Retractor**

Catalog #	Description
200-210	1" wide x 9" long (25mm x 228mm)

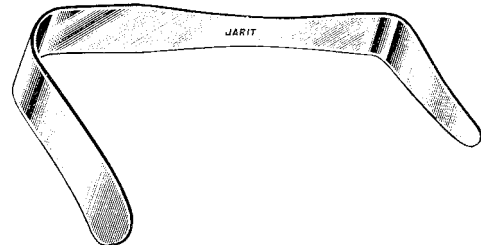

**Deaver Retractors**

hollow grip handle

Catalog #	Description
201-200	1" wide x 10" long (25mm x 254mm)
201-201	1" wide x 12" long (25mm x 305mm)
201-202	1" wide x 13" long (25mm x 330mm)
201-203	2½" wide x 14½" long (63mm x 368mm)
201-204	3½" wide x 12" long (89mm x 305mm)
201-205	2" wide x 12" long (50mm x 305mm)
201-206	3" wide x 12" long (75mm x 305mm)

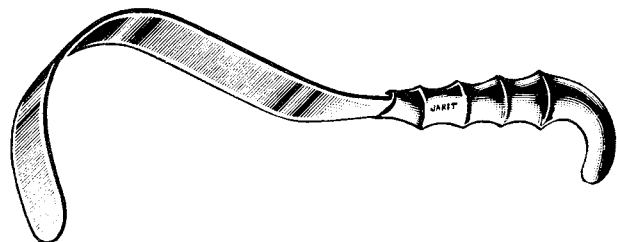

### Children's Hospital Retractor

double-ended

Catalog #	Description
200-116	5 <sup>3</sup> / <sub>4</sub> " (145mm), Small blade: 9 <sup>1</sup> / <sub>16</sub> " wide x 1 <sup>3</sup> / <sub>8</sub> " deep (14mm x 35mm) Large blade: 7 <sup>1</sup> / <sub>16</sub> " wide x 7 <sup>1</sup> / <sub>8</sub> " deep (11mm x 22mm)



### Ribbon Retractor

malleable blade, pediatric sizes

Catalog #	Description
200-217	1" wide x 10" long (25mm x 254mm)
200-218	5 <sup>1</sup> / <sub>8</sub> " wide x 6 <sup>3</sup> / <sub>4</sub> " long (16mm x 171mm)
200-219	1" wide x 7 <sup>1</sup> / <sub>2</sub> " long (25mm x 190mm)

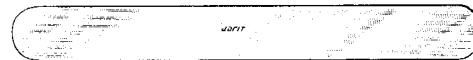

### Ribbon Retractors

malleable blade

Catalog #	Description
200-220	13" (330mm), 3 <sup>1</sup> / <sub>4</sub> " wide (19mm)
200-221	13" (330mm), 1" wide (25mm)
200-222	13" (330mm), 1 <sup>1</sup> / <sub>4</sub> " wide (32mm)
200-223	13" (330mm), 1 <sup>1</sup> / <sub>2</sub> " wide (38mm)
200-225	13" (330mm), 2" wide (51mm)
200-226	13" (330mm), 2 <sup>1</sup> / <sub>2</sub> " wide (64mm)
200-227	13" (330mm), 3" wide (76mm)
200-228	13" (330mm), 4" wide (102mm)

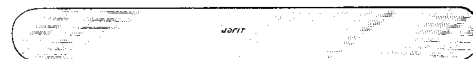

### Ribbon Retractors

hollow grip handle, malleable blade 13" (330mm),  
overall length 18" (457mm)

Catalog #	Description
201-220	3 <sup>1</sup> / <sub>4</sub> " wide (19mm)
201-221	1" wide (25mm)
201-222	1 <sup>1</sup> / <sub>4</sub> " wide (32mm)
201-223	1 <sup>1</sup> / <sub>2</sub> " wide (38mm)
201-225	2" wide (51mm)

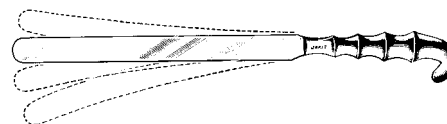

**Willauer-Deaver Retractors**

Catalog #	Description
200-235	15" length, 6¼" deep, 1" wide (380mm x 159mm x 25mm)
200-237	15¼" length, 6¼" deep, 2" wide (390mm x 159mm x 50mm)



**Weinberg Vagotomy Retractor**

Catalog #	Description
200-255	9" (229mm) Large blade: 3⅝" wide x 6¼" deep (93mm x 157mm) Small blade: 1⅞" wide x 2¼" deep (42mm x 57mm)

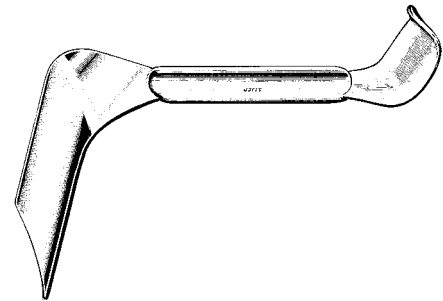

**Volkman Retractors, Sharp, (Satin Finish)**

Manufactured from high grade German surgical stainless steel which is ground and polished to a satin finish

Catalog #	Description
200-270	8½" (215mm), 2 prongs, 9mm x 8mm wide
200-271	8½" (215mm), 3 prongs, 9mm x 13mm wide
200-272	8½" (215mm), 4 prongs, 9mm x 18mm wide
200-273	8½" (215mm), 6 prongs, 9mm x 28mm wide

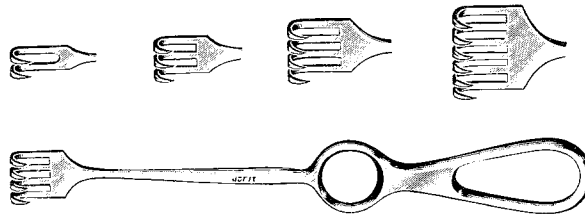

**Volkman Retractors, Sharp, (Matte Finish)**

Manufactured from high grade German surgical stainless steel which is glass beaded to a matte finish

Catalog #	Description
199-272	8½" (215mm), 4 prongs, 9mm x 18mm wide

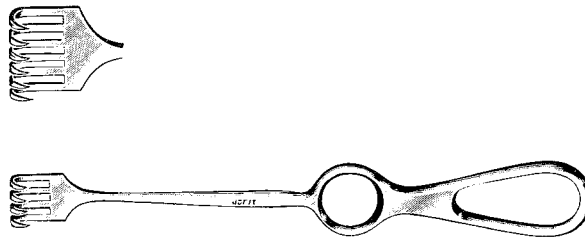

**Volkman Retractors, Blunt, (Satin Finish)**

Manufactured from high grade German surgical stainless steel which is ground and polished to a satin finish

Catalog #	Description
200-280	8½" (215mm), 2 prongs, 9mm x 8mm wide
200-281	8½" (215mm), 3 prongs, 9mm x 13mm wide
200-282	8½" (215mm), 4 prongs, 9mm x 18mm wide
200-283	8½" (215mm), 6 prongs, 9mm x 28mm wide

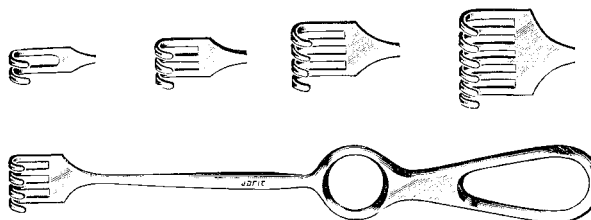

**Volkman Retractors, Blunt, (Matte Finish)**

Manufactured from high grade German surgical stainless steel which is glass beaded to a matte finish

Catalog #	Description
199-282	8½" (215mm), 4 prongs, 9mm x 18mm wide

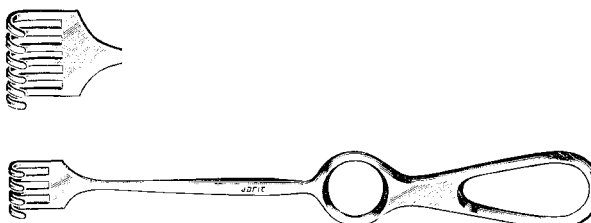

**Volkman Retractors, USA Pattern, Sharp, (Satin Finish)**

Manufactured from high grade German surgical stainless steel which is ground and polished to a satin finish

Catalog #	Description
200-290	9 1/8" (232mm), 2 prongs, 16mm x 11mm wide
200-291	9 1/8" (232mm), 3 prongs, 16mm x 18mm wide
200-292	9 1/8" (232mm), 4 prongs, 16mm x 26mm wide
200-293	9 1/8" (232mm), 6 prongs, 16mm x 40mm wide

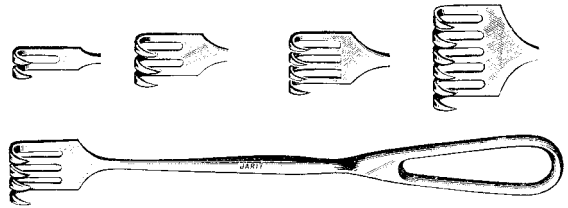

**Volkman Retractors, USA Pattern, Sharp, (Matte Finish)**

Manufactured from high grade German surgical stainless steel which is glass beaded to a matte finish

Catalog #	Description
199-292	9 1/8" (232mm), 4 prongs, 16mm x 26mm wide

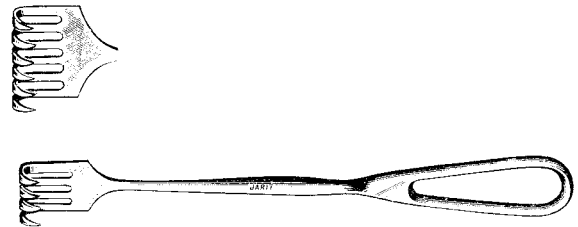

**Volkman Retractors, USA Pattern, Blunt, (Satin Finish)**

Manufactured from high grade German surgical stainless steel which is ground and polished to a satin finish

Catalog #	Description
200-295	9 1/8" (232mm), 2 prongs, 16mm x 11mm wide
200-296	9 1/8" (232mm), 3 prongs, 16mm x 18mm wide
200-297	9 1/8" (232mm), 4 prongs, 16mm x 26mm wide
200-298	9 1/8" (232mm), 6 prongs, 16mm x 40mm wide

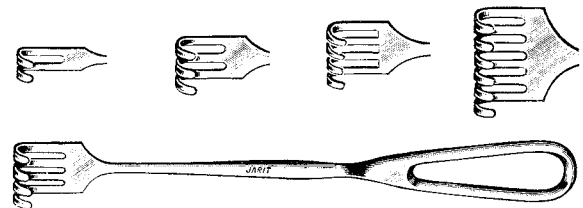

**Volkman Retractors, USA Pattern, Blunt, (Matte Finish)**

Manufactured from high grade German surgical stainless steel which is glass beaded to a matte finish

Catalog #	Description
199-297	9 1/8" (232mm), 4 prongs, 16mm x 26mm wide

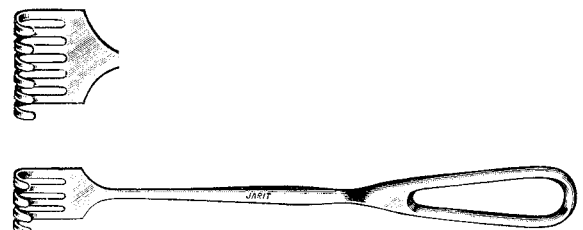

### Murphy Retractors

sharp

Catalog #	Description
200-300	7 <sup>3</sup> / <sub>4</sub> " (200mm), 2 prongs, 10.7mm x 8.5mm wide
200-301	7 <sup>3</sup> / <sub>4</sub> " (200mm), 3 prongs, 10.7mm x 12.75mm wide
200-302	7 <sup>3</sup> / <sub>4</sub> " (200mm), 4 prongs, 10.7mm x 18.9mm wide
200-303	7 <sup>3</sup> / <sub>4</sub> " (200mm), 6 prongs, 10.7mm x 28mm wide

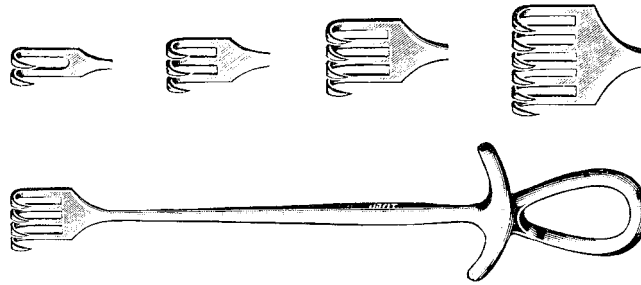

### Murphy Retractors

blunt

Catalog #	Description
200-310	7 <sup>3</sup> / <sub>4</sub> " (200mm), 2 prongs, 10.7mm x 8.5mm wide
200-311	7 <sup>3</sup> / <sub>4</sub> " (200mm), 3 prongs, 10.7mm x 12.75mm wide
200-312	7 <sup>3</sup> / <sub>4</sub> " (200mm), 4 prongs, 10.7mm x 18.9mm wide
200-313	7 <sup>3</sup> / <sub>4</sub> " (200mm), 6 prongs, 10.7mm x 28mm wide

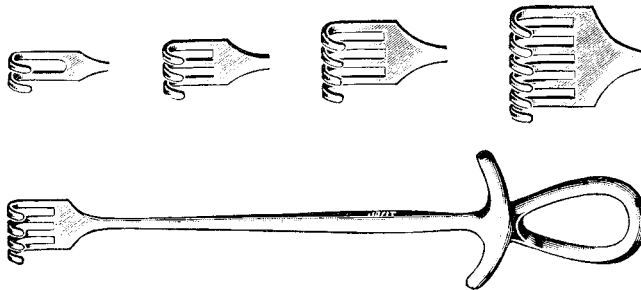

### Israel Retractor

blunt

Catalog #	Description
200-315	7 <sup>1</sup> / <sub>4</sub> " (187mm), 4 prongs, 48mm x 42mm wide

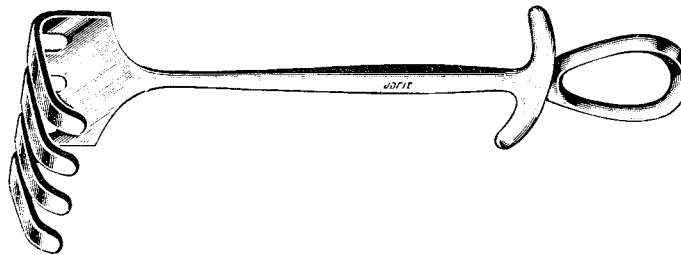

### Ollier Retractor

blunt

Catalog #	Description
200-318	9" (230mm), 4 prongs, 42mm x 56mm wide

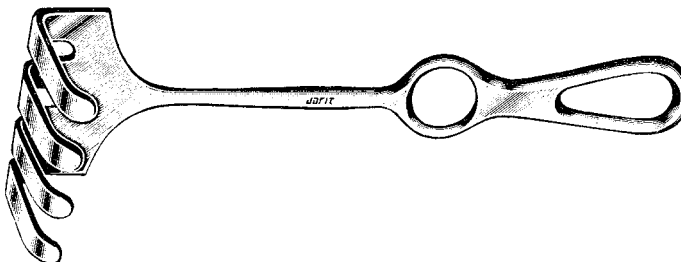

**Alm Retractor**

Catalog #	Description
205-100	2 3/4" (70mm), 2" (50mm) spread

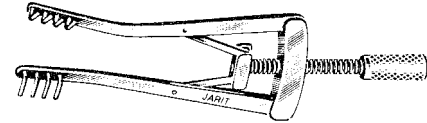

**Alm Retractor**

Catalog #	Description
205-105	3 7/8" (100mm), 2 1/2" (64mm) spread

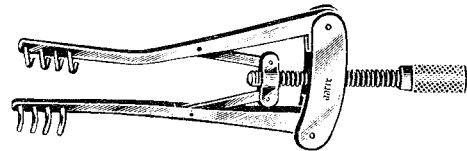

**Heiss Automatic Skin Retractor**

Catalog #	Description
205-110	3 7/8" (100mm), 1" (25mm) spread, sharp prongs
205-111	3 7/8" (100mm), 1" (25mm) spread, blunt prongs

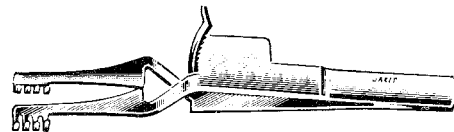

**Gelpi Perineal Retractor, (Satin Finish)**

Manufactured from high grade German surgical stainless steel which is ground and polished to a satin finish

Catalog #	Description
205-120	7 1/2" (190mm)

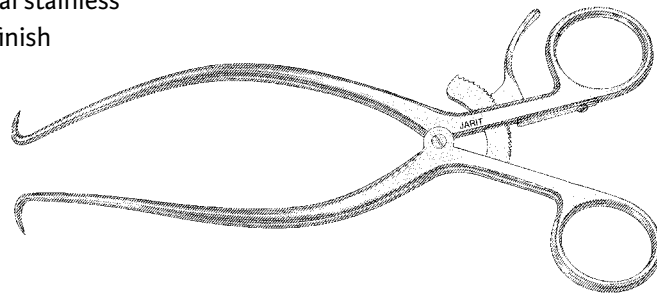

**Gelpi Perineal Retractor, (Matte Finish)**

Manufactured from high grade German surgical stainless steel which is glass beaded to a matte finish

Catalog #	Description
204-120	7 3/4" (195mm)
205-SPS-120	Replacement Spring and Screw

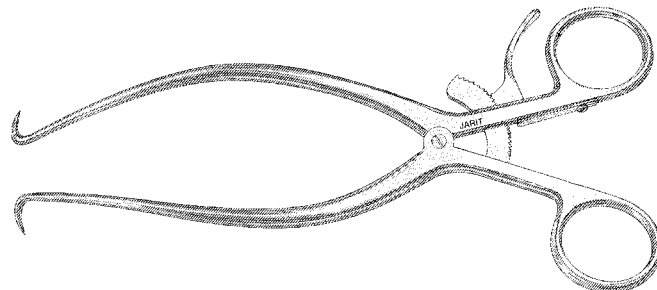



### Gelpi Perineal Retractor

with ball stops

Catalog #	Description
205-121	7 <sup>3</sup> / <sub>4</sub> " (195mm)
205-SPS-120	Replacement Spring and Screws

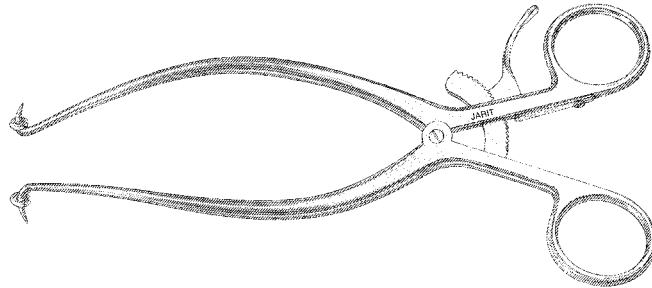

### Gelpi Perineal Retractors, pediatric sizes, (Satin Finish)

Manufactured from high grade German surgical stainless steel which is ground and polished to a satin finish

Catalog #	Description
205-123	3 <sup>7</sup> / <sub>8</sub> " (97mm)
205-124	4 <sup>3</sup> / <sub>8</sub> " (117mm)
205-125	5 <sup>1</sup> / <sub>8</sub> " (130mm)
205-SPS-123	Replacement Spring and Screw
205-SPS-124	Replacement Spring and Screw

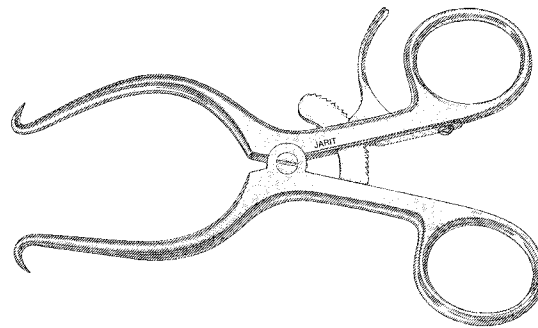

### Gelpi Perineal Retractor, pediatric sizes, (Matte Finish)

Manufactured from high grade German surgical stainless steel which is glass beaded to a matte finish

Catalog #	Description
204-123	3 <sup>3</sup> / <sub>4</sub> " (95mm)
204-124	4 <sup>3</sup> / <sub>4</sub> " (120mm)
204-125	5 <sup>1</sup> / <sub>4</sub> " (133mm)
205-SPS-123	Replacement Spring and Screw
205-SPS-124	Replacement Spring and Screw

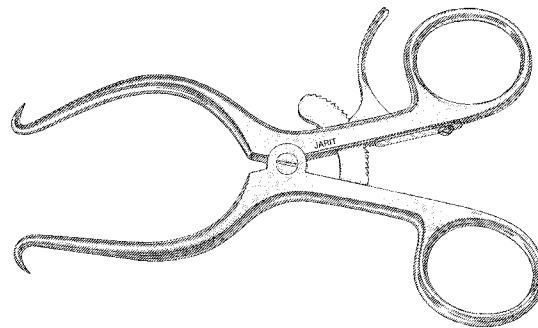

### Farr Style Spring Retractors

Catalog #	Description
205-127	5½" (140mm), ½" (14mm) tips
205-128	5½" (140mm), ⅝" (15mm) tips
205-130	1½" (38mm), 10mm sharp points
205-131	2" (50mm), 11mm sharp points
205-132	2¼" (58mm), 11mm sharp points
205-133	2½" (64mm), 11mm sharp points
205-134	3" (75mm), 11mm sharp points
205-135	2½" (64mm), 12mm flat blades

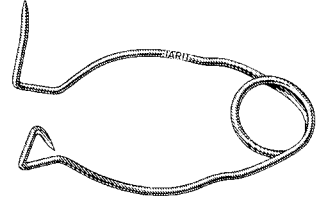

### Spring Wire Retractors

Catalog #	Description
205-136	3" (75mm), style 1, 10.5mm sharp points
205-137	3½" (90mm), style 2, 11mm x 15.5mm flat blades
205-138	4½" (115mm), style 3, 15.5mm x 20.5mm flat blades

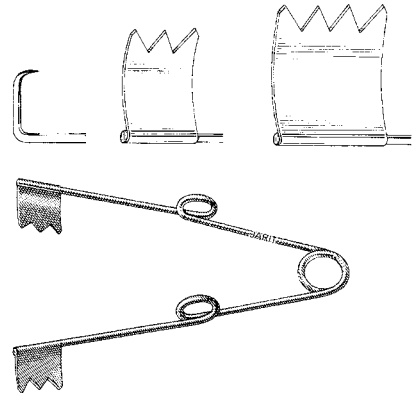

### Weitlaner Retractors, (Satin Finish)

Manufactured from high grade German surgical stainless steel which is ground and polished to a satin finish

Catalog #	Description
205-140	4 <sup>3</sup> / <sub>8</sub> " (110mm)
205-141	4 <sup>3</sup> / <sub>8</sub> " (110mm)
205-150	5 <sup>3</sup> / <sub>8</sub> " (135mm)
205-151	5 <sup>3</sup> / <sub>8</sub> " (135mm)
205-155	6 <sup>1</sup> / <sub>2</sub> " (165mm)
205-156	6 <sup>1</sup> / <sub>2</sub> " (165mm)
205-160	7 <sup>3</sup> / <sub>4</sub> " (195mm)
205-161	7 <sup>3</sup> / <sub>4</sub> " (195mm)
205-165	9 <sup>1</sup> / <sub>2</sub> " (240mm)
205-166	9 <sup>1</sup> / <sub>2</sub> " (240mm)

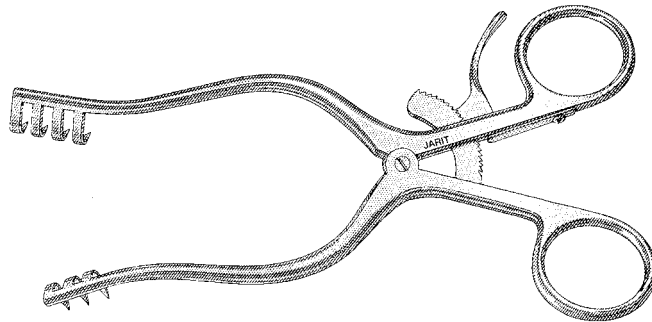

### Weitlaner Retractors, (Matte Finish)

Manufactured from high grade German surgical stainless steel which is glass beaded to a matte finish

Catalog #	Description
204-140	4 <sup>3</sup> / <sub>8</sub> " (110mm)
204-141	4 <sup>3</sup> / <sub>8</sub> " (110mm)
204-150	5 <sup>3</sup> / <sub>8</sub> " (135mm)
204-151	5 <sup>3</sup> / <sub>8</sub> " (135mm)
204-155	6 <sup>1</sup> / <sub>2</sub> " (165mm)
204-156	6 <sup>1</sup> / <sub>2</sub> " (165mm)
204-160	7 <sup>3</sup> / <sub>4</sub> " (195mm)
204-161	7 <sup>3</sup> / <sub>4</sub> " (195mm)
204-165	9 <sup>1</sup> / <sub>2</sub> " (240mm)
204-166	9 <sup>1</sup> / <sub>2</sub> " (240mm)

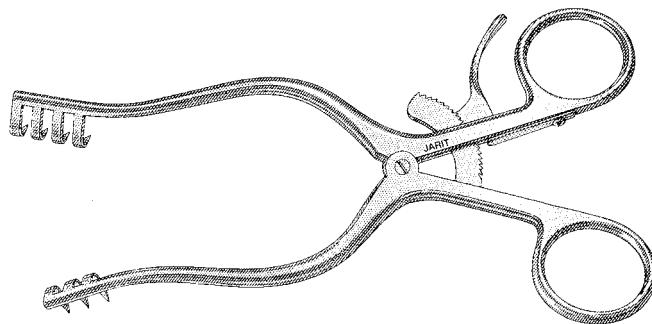

### Weitlaner Retractor Replacement Parts

Catalog #	Description
205-SPS-140	Replacement Spring and Screw
205-SPS-141	Replacement Spring and Screw
205-SPS-150	Replacement Spring and Screw
205-SPS-151	Replacement Spring and Screw
205-SPS-155	Replacement Spring and Screw
205-SPS-156	Replacement Spring and Screw
205-SPS-160	Replacement Spring and Screw
205-SPS-161	Replacement Spring and Screw

**Weitlaner Retractors**

hinged blades

Catalog #	Description
205-175	5½" (140mm), 3 x 4 sharp prongs, 18mm deep
205-176	5½" (140mm), 3 x 4 blunt prongs, 18mm deep
205-180	6½" (162mm), 3 x 4 sharp prongs, 18mm deep
205-181	6½" (162mm), 3 x 4 blunt prongs, 18mm deep
205-190	8¼" (210mm), 3 x 4 sharp prongs, 20mm deep

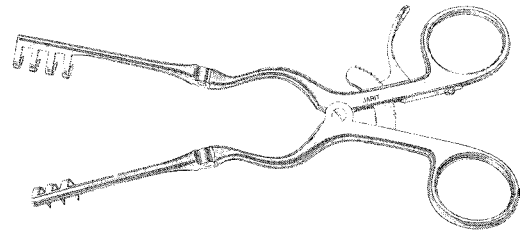

**Adson Cerebellar Retractors**

straight

Catalog #	Description
205-200	7¾" (195mm), 4 x 4 sharp prongs, 22mm deep
205-201	7¾" (195mm), 4 x 4 blunt prongs, 22mm deep

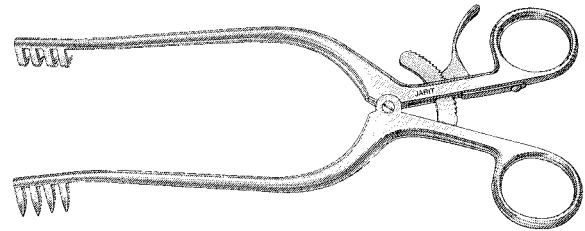

**Adson Cerebellar Retractors**

angled

Catalog #	Description
205-205	7¼" (182mm), angled, 4 x 4 sharp prongs, 22mm deep
205-206	7¼" (182mm), angled shanks, angular, 4 x 4 blunt prongs, 22mm deep

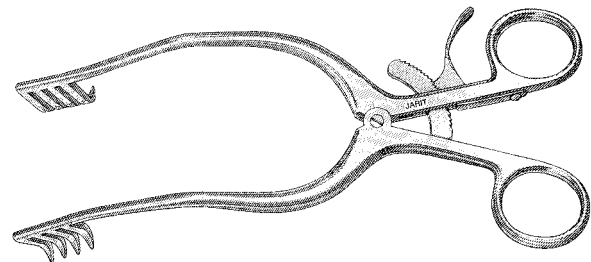

**Beckman Thyroid Retractors, Hinged Blades**

Catalog #	Description
205-209	9½" (240mm), 3 x 4 sharp prongs, 1½" deep (28mm)
205-210	12¾" (316mm), 4 x 4 sharp prongs, 5/8" deep (16mm)

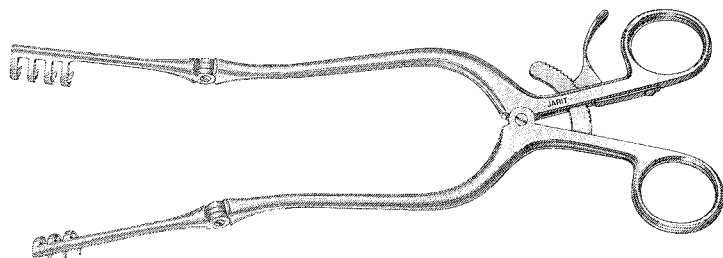

### Beckman-Adson Retractors, Hinged Blades

Catalog #	Description
205-220	12¼" (309mm), 4 x 4 sharp prongs, 1" x 1" deep (25mm x 25mm)
205-221	12¼" (309mm), 4 x 4 blunt prongs, 1" x 1" deep (25mm x 25mm)
205-225	12¼" (309mm), 4 x 4 sharp prongs, 1" x 1¾" deep (25mm x 44mm)
205-226	12¼" (309mm), 4 x 4 blunt prongs, 1" x 1¾" deep (25mm x 44mm)

205-SPS-226 Replacement Spring and Screws



### Beckman-Eaton Retractor, Hinged Blades

Catalog #	Description
205-230	12¾" (324mm), 7 x 7 sharp prongs, 1¾" x 1⅞" deep (44mm x 48mm)

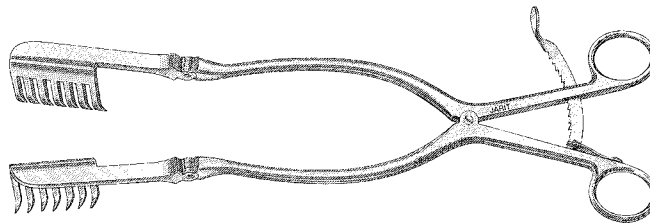

### Mayo-Adams Retractor

Catalog #	Description
205-235	6½" (168mm), removable center blade 7" x ⅜" x 1⅝" (180mm x 41mm x 10mm)

205-CBL-235 Removable center blade 7" x ⅜" x 1⅝" (180mm x 41mm x 10mm)

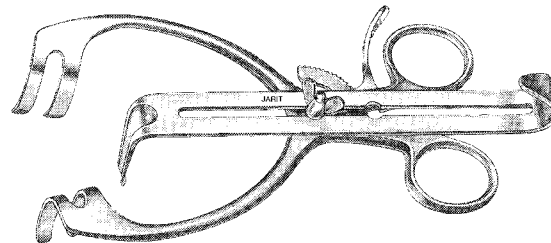

### Rigby Retractor

Catalog #	Description
205-237	7½" (190mm), blades ⅞" x 2 1/34" deep (21mm x 69mm)

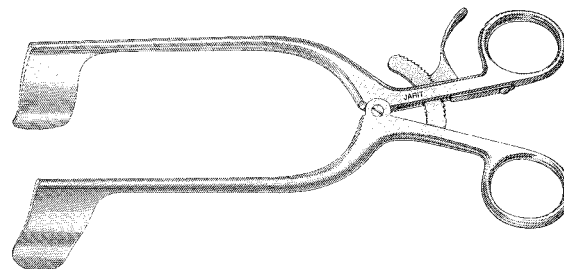

**Meyerding Laminectomy Retractors**

Catalog #	Description
205-240	7¾" (194mm), blades 1" x 1¼" deep (25mm x 31mm)
205-242	7¾" (194mm), blades 1" x 2⅛" deep (25mm x 54mm)
205-244	7¾" (194mm), blades ¾" x 2⅜" deep (19mm x 63mm)
205-245	7¾" (194mm), blades 1" x 2⅜" deep (25mm x 60mm)

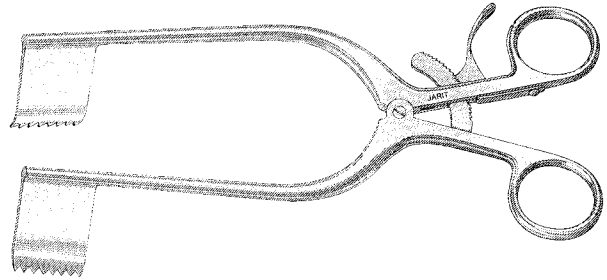

**Gosset Retractor**

Catalog #	Description
205-251	5½" (140mm) spread, blades 1" x 2½" deep (25mm x 64mm)

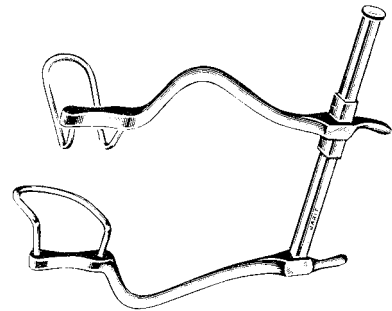

**Markham-Meyerding Hemilaminectomy Retractor**

Catalog #	Description
205-255	6¾" (170mm), blade 1" x 2½" deep (25mm x 64mm), blade on right side

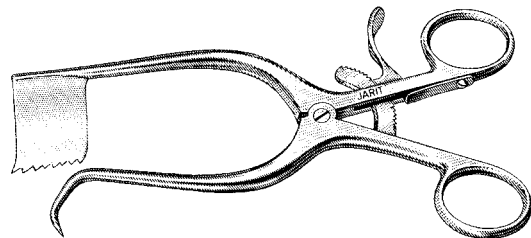

**Markham-Meyerding Hemilaminectomy Retractor**

Catalog #	Description
205-256	6¾" (170mm), blade 1" x 2½" deep (25mm x 64mm), blade on left side

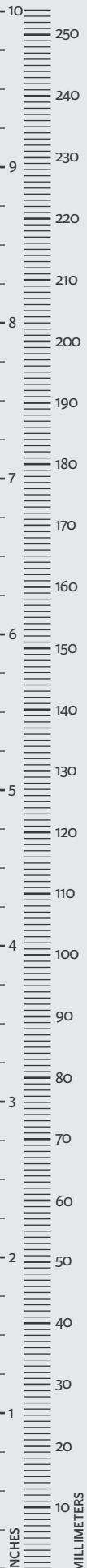
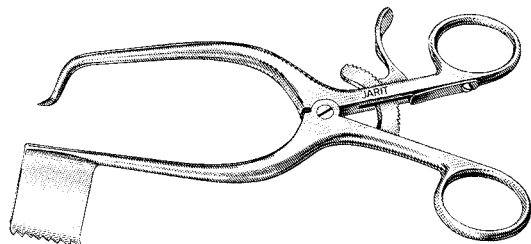

**Balfour Retractors**

"Spread" is measured: distal tip of blade or proximal end where blade attaches to arm.

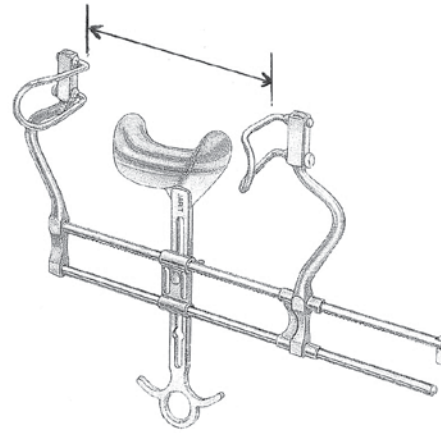

**Balfour Abdominal Retractors**

with attached wire lateral blades 2" (51mm) deep

set includes: 205-298, 1 each center blade, 3 1/8" wide x 1 7/8" deep (80mm x 48mm)

Catalog #	Description
205-270	7" (176mm) spread
205-275	9 1/2" (243mm) spread
205-ESC-270	Replacement End Screws pkg/6ea
205-SLB-270	Replacement Sliding Bracket
205-WGN-270	Replacement Wing Nut pkg/6ea

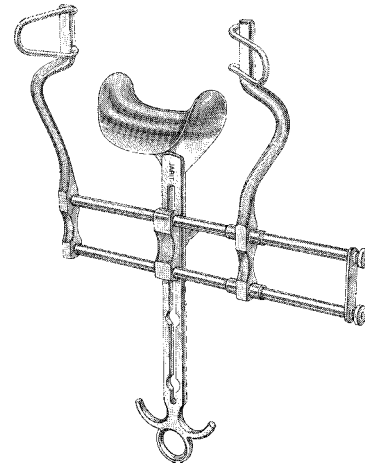

**Balfour Abdominal Retractors**

with attached solid lateral blades 2" (51mm) deep

set includes: 205-298, 1 each center blade, 3 1/8" wide x 1 7/8" deep (80mm x 48mm)

Catalog #	Description
205-280	7" (176mm) spread
205-ESC-270	Replacement End Screws pkg/6ea

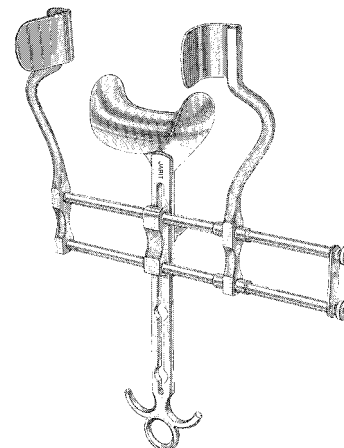

**Balfour Abdominal Retractor**

with attached wire lateral blades 2" (51mm) deep

set includes: 205-298, 1 each center blade, 3 1/8" wide x 1 7/8" deep (80mm x 48mm)

Catalog #	Description
205-290	7" (176mm) spread
205-291	9 1/2" (243mm) spread
205-SLB-290	Slide bar only
205-SLB-291	Slide bar only
205-FRM-291	Frame only

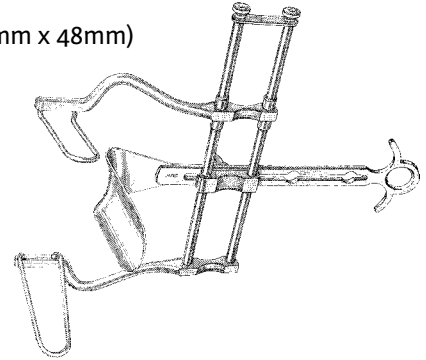

**Balfour Abdominal Retractor with Ratchet Bar**

Catalog #	Description
205-295	7" (178mm) spread Set includes: 205-335, 1 pair 2" (51mm), deep interchangeable wire lateral blades 205-336, 1 pair 3" (76mm), deep interchangeable wire lateral blades 205-292, 1 each center blade, 2 5/8" wide x 1 1/2" deep (67mm x 38mm) 205-293, 1 each center blade, 3 1/4" x 2 3/4" deep (83mm x 70mm)

205-SLB-295 Slide bar only

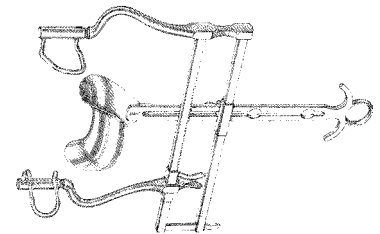

**Balfour Abdominal Retractor with Ratchet Bar**

Catalog #	Description
205-296	10" (254mm) spread Set includes: 205-335, 1 pair 2" (51mm), deep interchangeable wire lateral blades 205-336, 1 pair 4" (102mm), deep interchangeable wire lateral blades 205-298, 1 each center blade, 3 1/8" wide x 1 7/8" deep (80mm x 48mm) 205-299, 1 each center blade, 2 1/2" x 4" deep (64mm x 101mm)

205-SLB-296 Slide bar only

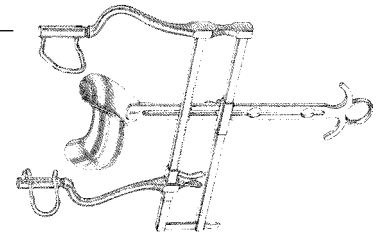

**Balfour Wire Lateral Blades, 2/Per**

Catalog #	Description
205-335	2" (50mm) deep
205-336	3" (76mm) deep
205-337	4" (102mm) deep

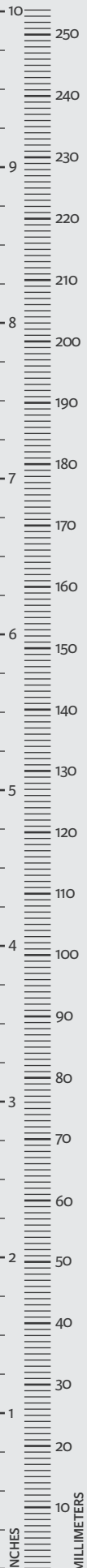
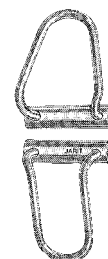



**Balfour Center Blade**

Catalog #	Description
205-292	12" (306mm), standard 2 <sup>5</sup> / <sub>8</sub> " wide x 1 <sup>1</sup> / <sub>2</sub> " deep (68mm x 38mm)

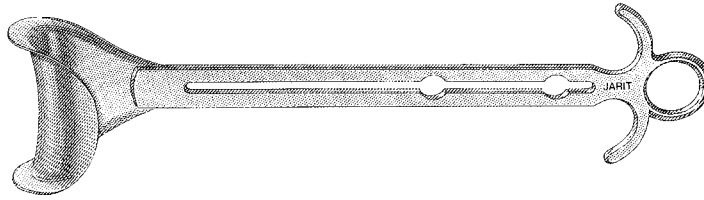

**Balfour Center Blade**

Catalog #	Description
205-293	12 <sup>1</sup> / <sub>4</sub> " (309mm), supra-pubic, 3 <sup>1</sup> / <sub>4</sub> " wide x 2 <sup>7</sup> / <sub>8</sub> " deep (84mm x 72mm)

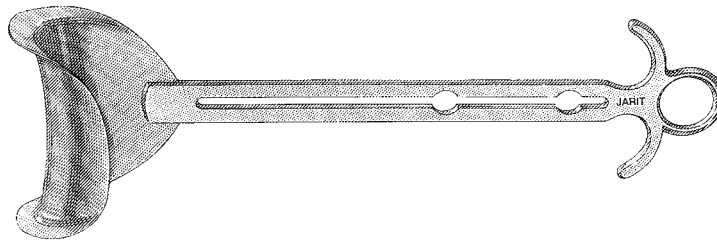

**Balfour Center Blade (Horgan)**

Catalog #	Description
205-294	12 <sup>1</sup> / <sub>4</sub> " (310mm), Horgan, malleable, 2" wide x 5 <sup>5</sup> / <sub>8</sub> " deep (50mm x 142mm)

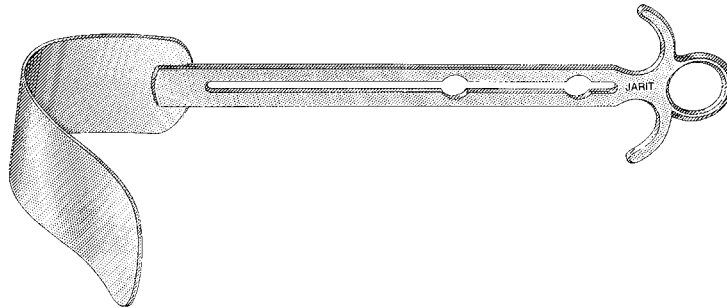

**Balfour Center Blade**

Catalog #	Description
205-298	12" (306mm), standard 3 <sup>1</sup> / <sub>8</sub> " wide x 1 <sup>7</sup> / <sub>8</sub> " deep (80mm x 48mm)

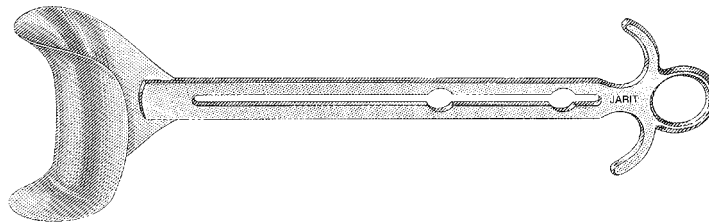

**Balfour Center Blade**

Catalog #	Description
205-299	11 <sup>1</sup> / <sub>2</sub> " (292mm), extra deep, 2 <sup>3</sup> / <sub>8</sub> " wide x 3 <sup>7</sup> / <sub>8</sub> " deep (60mm x 100mm)

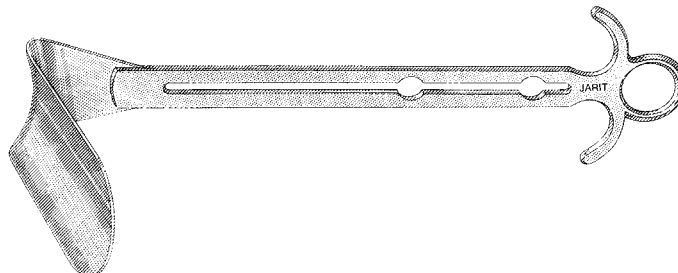

### Balfour Abdominal Retractor with Ratchet Bar

Catalog #	Description
205-300	7" (178mm) spread with attached 2" (51mm) deep wire lateral blades  Set includes: 205-298, 1 each center blade, 3 1/8" wide x 1 7/8" deep (80mm x 48mm)
205-305	7" (178mm) spread with attached 4" (101mm) deep wire lateral blades  Set includes: 205-298, 1 each center blade, 3 1/8" wide x 1 7/8" deep (80mm x 48mm)
205-SPS-305	Replacement Spring and Screw

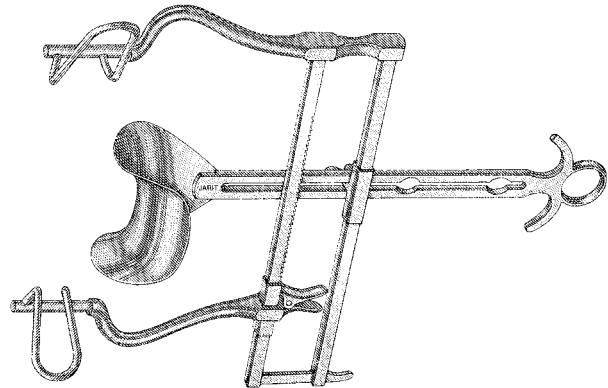

### Balfour Abdominal Retractor, Pediatric Size

Catalog #	Description
205-310	3 1/2" (89mm) spread  Set includes: attached 1 3/8" (35mm) deep wire lateral blades 205-CTR-310, 1 each center blade 7/8" wide x 7/8" deep (22mm x 22mm)
205-KNT-310	Replacement Knurled Nut pkg/6ea
205-CTR-310	Replacement Center Blade 1" x 1" x 3 3/8" (24mm x 25mm x 87mm)
205-ESC-310	Replacement End Screw
205-SBW-310	Replacement Slide Bar and Wing Nut
205-TSC-310	Replacement Thumb Screw

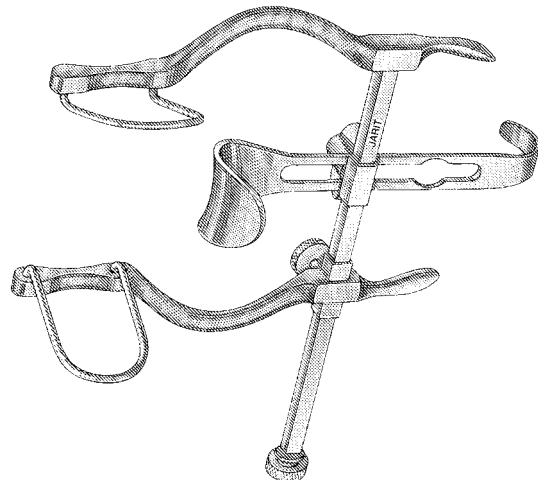

### Balfour Abdominal Retractor with Ratchet Bar Positioning Mechanism

Catalog #	Description
205-315	7¾" (197mm) spread Set includes: 205-330, 1 pair 2½" (64mm), deep interchangeable wire lateral blades 205-331, 1 pair 3½" (88mm), deep interchangeable wire lateral blades 205-320, 1 each center blade, 2⅝" wide x 1⅝" deep (67mm x 42mm) Snap-on lateral blades can be attached and removed in seconds
205-316	10½" (267mm) spread Set includes: 205-330, 1 pair 2½" (64mm), deep interchangeable wire lateral blades 205-331, 1 pair 3½" (88mm), deep interchangeable wire lateral blades 205-320, 1 each center blade, 2⅝" wide x 1⅝" deep (67mm x 42mm) Snap-on lateral blades can be attached and removed in seconds
205-ARM-315	Replacement Removable Arm only
205-FRM-315	Replacement Frame only for 205-315
205-SLB-315	Replacement Slide bar w/Wing Nut
205-FRM-316	Replacement Frame only for 205-316

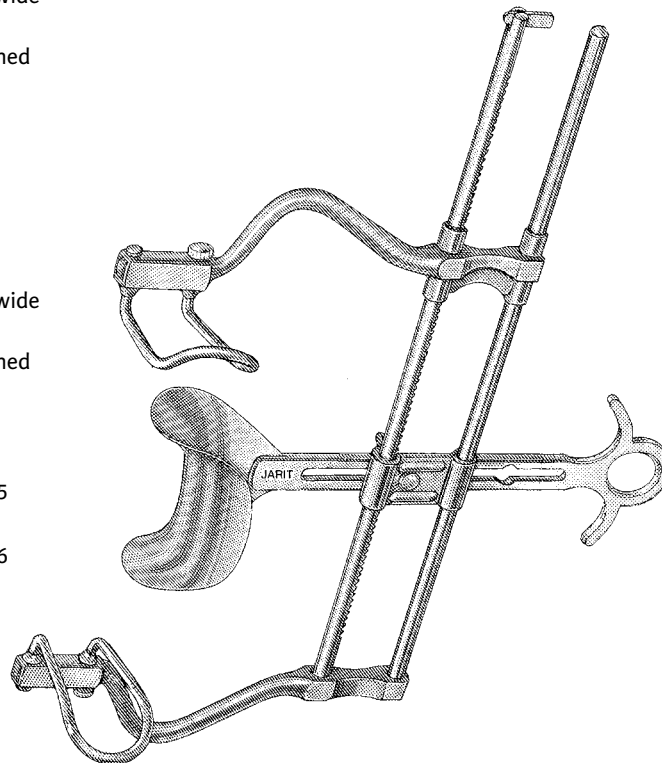

### Balfour Wire Lateral Blades

for 205-315 and 205-316, supplied in pairs (2/Per)

Catalog #	Description
205-330	2½" (64mm) deep
205-331	3½" (89mm) deep
205-332	4" (101mm) deep

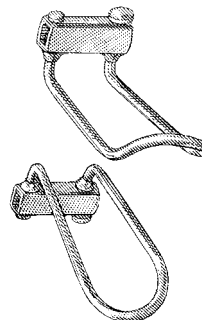

**Balfour Center Blade**

for 205-315 and 205-316

Catalog #	Description
205-320	10 <sup>3</sup> / <sub>4</sub> " (270mm), standard 2 <sup>5</sup> / <sub>8</sub> " wide x 1 <sup>5</sup> / <sub>8</sub> " deep (67mm x 42mm)

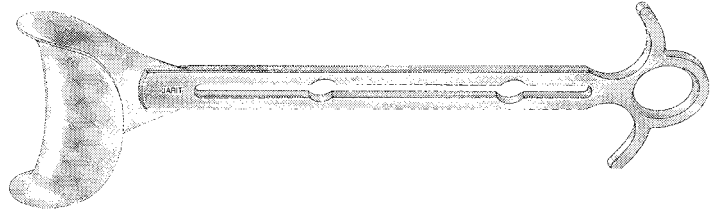

**Balfour Center Blade**

for 205-315 and 205-316

Catalog #	Description
205-321	10 <sup>3</sup> / <sub>4</sub> " (270mm), standard, 3 <sup>5</sup> / <sub>8</sub> " wide x 1 <sup>3</sup> / <sub>4</sub> " deep (92mm x 44mm)

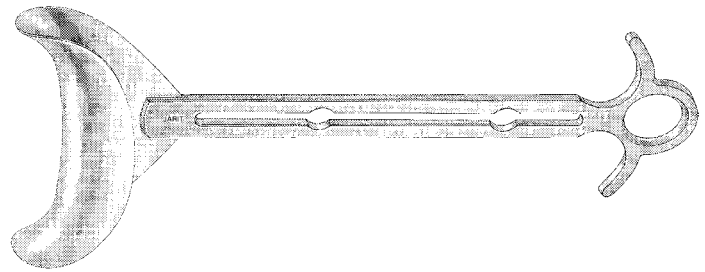

**Balfour Center Blade**

for 205-315 and 205-316

Catalog #	Description
205-322	10 <sup>3</sup> / <sub>4</sub> " (270mm), supra-pubic, 2 <sup>5</sup> / <sub>8</sub> " wide x 2 <sup>3</sup> / <sub>4</sub> " deep (67mm x 70mm)

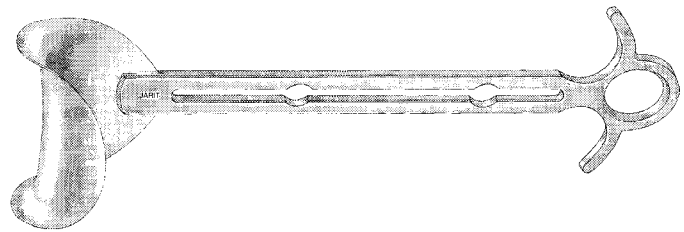

**Balfour Center Blade**

for 205-315 and 205-316

Catalog #	Description
205-323	10 <sup>3</sup> / <sub>4</sub> " (270mm), supra-pubic, 3 <sup>1</sup> / <sub>4</sub> " wide x 2 <sup>3</sup> / <sub>4</sub> " deep (83mm x 69mm)

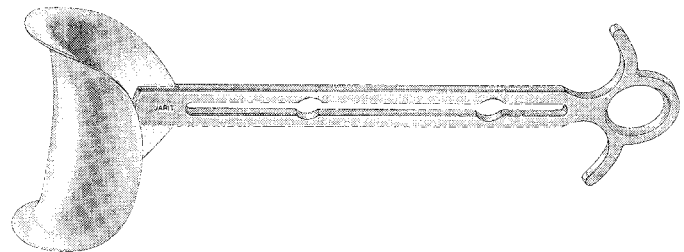

**Balfour Center Blade (Horgan)**

for 205-315 and 205-316

Catalog #	Description
205-324	15 <sup>3</sup> / <sub>4</sub> " (400mm), Horgan, malleable, 2" wide x 7 <sup>3</sup> / <sub>4</sub> " deep (51mm x 195mm)

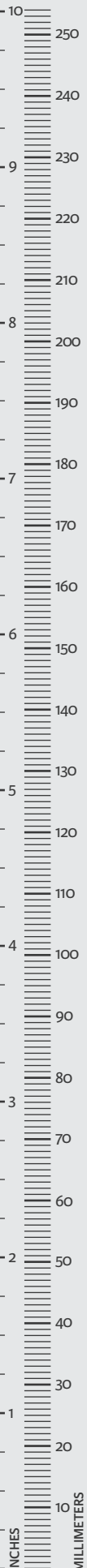
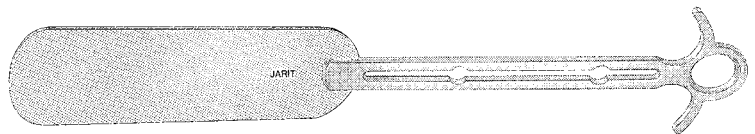

**Balfour Fourth Blade Attachments**

for 205-315 and 205-316 (center blade not included)

Catalog #	Description
205-312	For right arm, arm depth 241mm
205-313	For left arm (illustrated), arm depth 241mm
205-SB-312	Replacement Slide Bar (clamp)

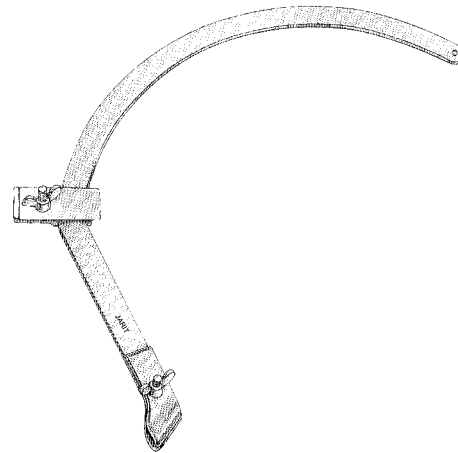

**O'Sullivan-O'Connor Abdominal Retractor**

with 3 removable and 2 fixed blades

Catalog #	Description
205-325	Opening 189mm x 141mm Removable blades: 1 3/4" x 3 1/4" deep (46mm x 83mm) 1 3/4" x 3 1/4" deep (46mm x 83mm) 2 7/8" x 4 3/8" deep (72mm x 112mm) Fixed blades: 1" x 2 5/8" deep (25mm x 66mm)
205-FRM-325	Replacement Frame only
205-SRW-325	Replacement Screw
205-WGN-325	Replacement Wing Nut
205-BLD-325	Replacement Blades (Set of 3)
205-SBL-325	Replacement Small Blade only
205-LBL-325	Replacement Large Blade only

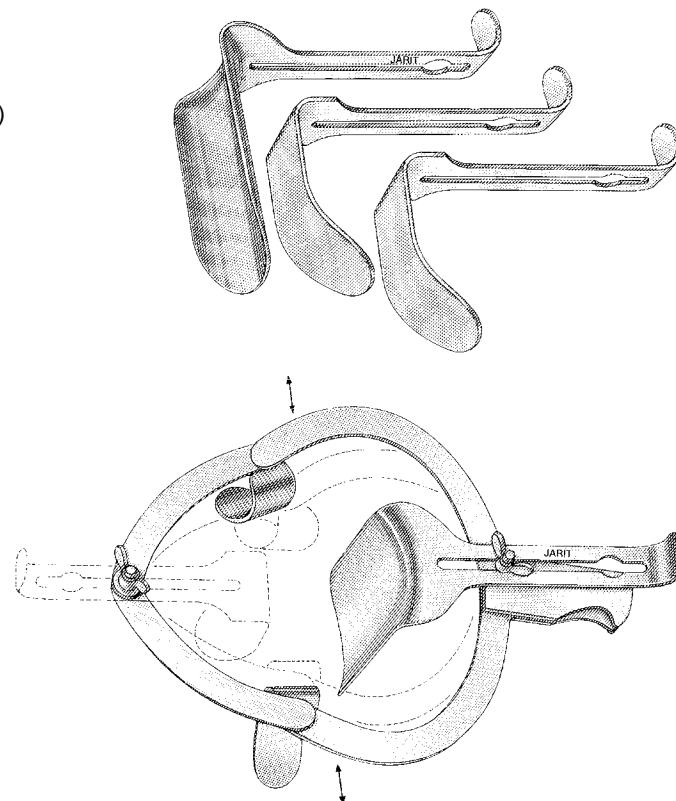

The Seton Shallow Surgical Retractor is a four sided stainless steel surgical retractor developed to aid the surgeon during shallow or superficial surgery with the use of a combination of different retractor blades, toothed or cupped.

- A complete, obstruction-free surgical window.
- A reduction of extraneous motion, fatigue and constant repositioning.
- An operative window that can be incrementally increased or decreased.
- The ability to perform an unassisted surgical procedure.

### Seton\* Shallow Surgical Retractor

Catalog #	Description
<b>205-500</b>	Complete set includes: 205-502, 1 ea: retractor frame 205-504, 1 ea: retractor blade semi-sharp, 1" x 2" (25mm x 53mm) 205-506, 1 ea: retractor blade semi-sharp, 1" x 1 1/8" (25mm x 30mm) 205-508, 1 ea: retractor blade semi-sharp, 1" x 11/16" (25mm x 20mm) 205-510, 1 ea: retractor blade Balfour-type, 7/8" x 2" (21mm x 51mm) 205-512, 1 ea: retractor blade Balfour-type, 1 1/8" x 1 1/4" (27mm x 33mm) 205-514, 1 ea: retractor blade Balfour-type, 7/8" x 1 1/8" (21mm x 27mm)
<b>205-502</b>	Retractor Frame, 1" x 2 1/8" (25mm x 53mm)

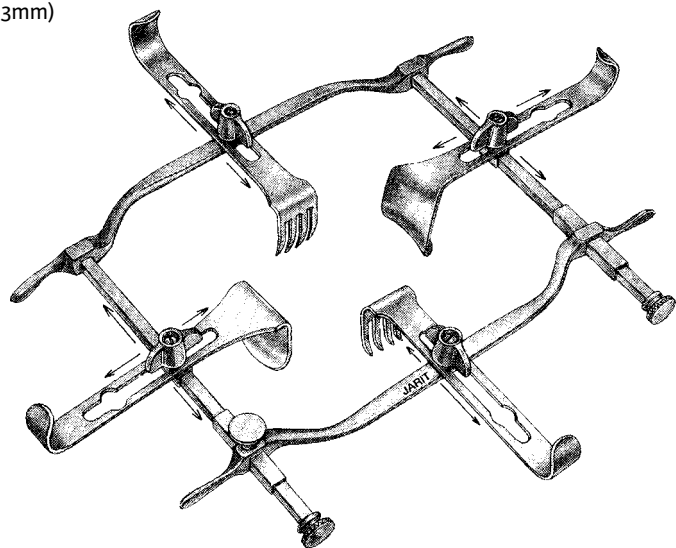

\*Developed in cooperation with Joseph Z. Seton, M.D., Lenox Hill Hospital, New York, New York.

### Seton Retractor Blades

semi-sharp type

Catalog #	Description
205-504	4 prong semi-sharp, set of two, 1" x 2" deep (25mm x 53mm)
205-506	4 prong semi-sharp, set of two, 1" x 1½" deep (25mm x 30mm)
205-508	4 prong semi-sharp, set of two, 1" x 11/16" deep (25mm x 20mm)

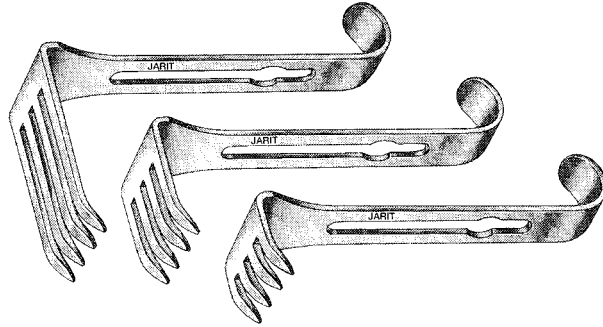

### Seton Retractor Blades

Balfour-type

Catalog #	Description
205-510	Balfour-type, set of two, 7/8" x 2" deep (21mm x 51mm)
205-512	Balfour-type, set of two, 1½" x 1¼" deep (27mm x 33mm)
205-514	Balfour-type, set of two, 7/8" x 1½" deep (21mm x 27mm)

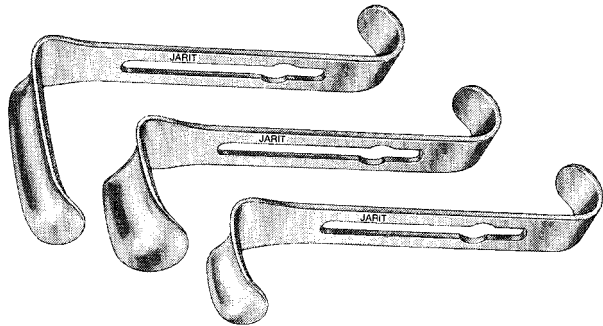

## Henly Retractor

Catalog #	Description
205-530	7" (180mm), improved pattern, with interchangeable lateral and center blades
	Complete set includes: 1 frame
205-532	1 pair lateral blades, blunt, 7/8" wide x 1" deep (22mm x 25mm)
205-534	1 pair lateral blades, blunt, 7/8" wide x 2" deep (22mm x 51mm)
205-536	1 pair lateral blades, blunt, 7/8" wide x 3" deep (22mm x 76mm)
205-540	1 center blade, 3/4" wide x 3/4" deep (18mm x 19mm)
205-542	1 center blade, 3/4" wide x 1" deep (18mm x 25mm)
205-544	1 center blade, 3/4" wide x 1 1/4" deep (18mm x 32mm)
205-FRM-530	Replacement Frame only

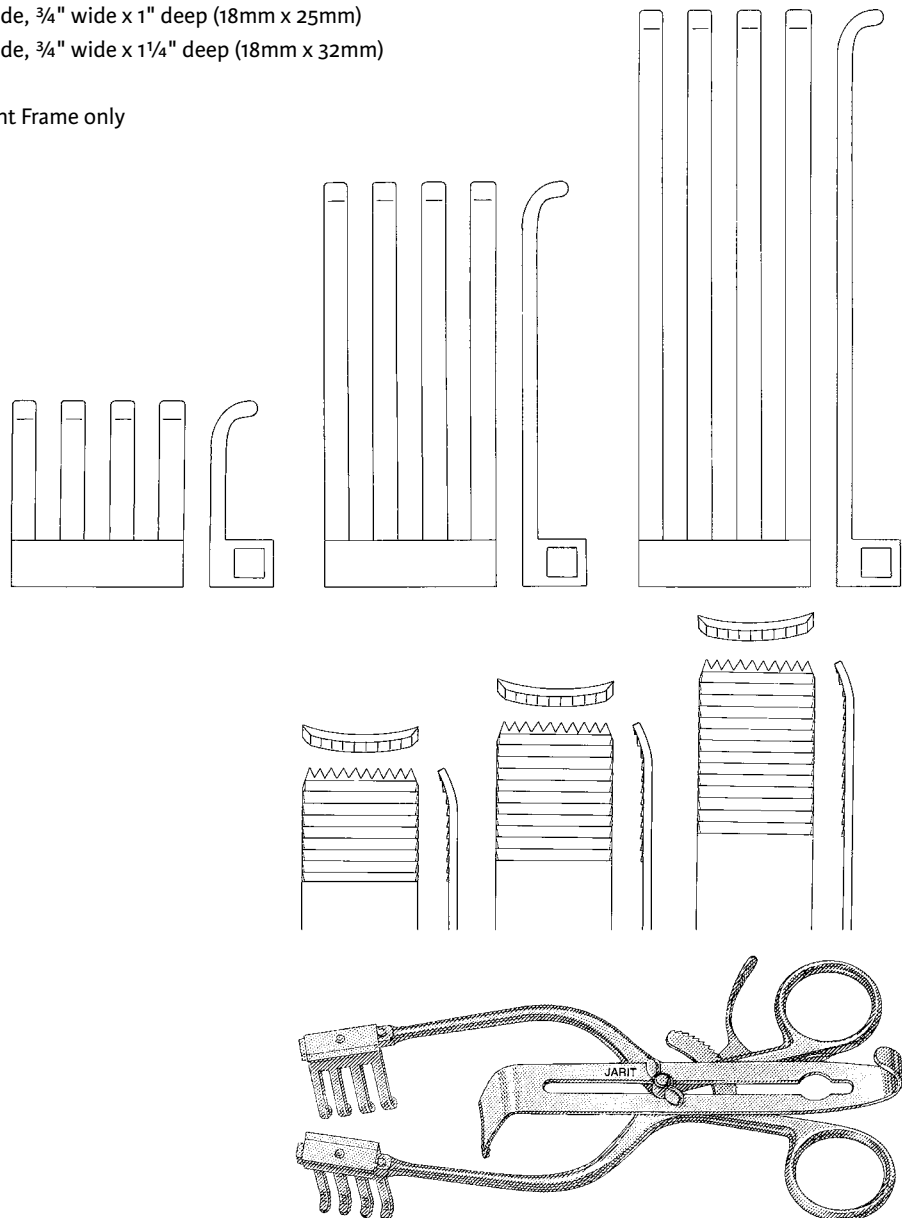



### Henly Retractor

Catalog #	Description
205-550	7" (180mm), original pattern, with 3 interchangeable center blades
	Center blades measure:
205-540	3/4" wide x 3/4" deep (18mm x 19mm)
205-542	3/4" wide x 1" deep (18mm x 25mm)
205-544	3/4" wide x 1 1/4" deep (18mm x 32mm)
205-FRM-550	Replacement Retractor Frame only

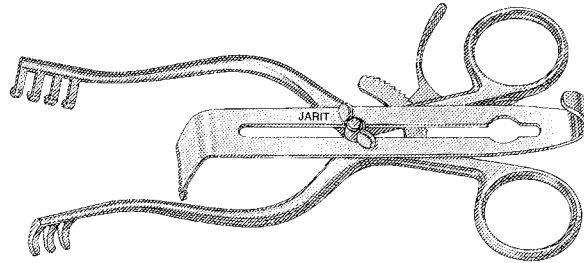

### Garrett, Peripheral Vascular Self-Retaining Retractor

Catalog #	Description
205-560	7 1/4" (184mm), retractor set consists of retractor body and 3 pairs of (6) detachable blades
205-561	Frame only
205-562	1 1/2" x 1 1/4" (37mm x 32mm)
205-563	1 1/2" x 2 1/4" (37mm x 57mm)
205-564	1 1/2" x 3 1/4" (37mm x 82mm)

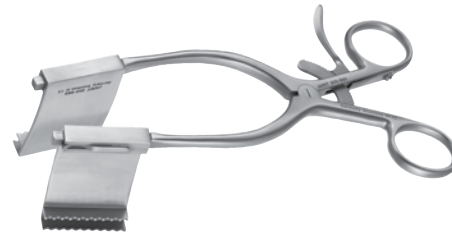

### Darling Popliteal Retractor, Self-Retaining

left: overall length 7" (175mm), total opening 3 3/4" (95mm)

Catalog #	Description
205-260	Short blade, width 1" (25mm), depth 2 5/8" (68mm), left Long blade, width 1 5/8" (40mm), depth 2 5/8" (68mm), left



### Darling Popliteal Retractor, Self-Retaining

right: overall length 7" (175mm), total opening 3 3/4" (95mm)

Catalog #	Description
205-261	Short blade, width 1" (25mm), depth 2 5/8" (68mm), right Long blade, width 1 5/8" (40mm), depth 2 5/8" (68mm), right



### Ochsner Vascular Retractor

self-retaining, swivel blades, flexible arms

overall length 8" (203mm), total opening 5½" (140mm)

Catalog #	Description
205-570	Arm length: ¾" (83mm) Blades: 1" (25mm) wide x 2" (52mm) depth





**Integra™**  
Orthopedic  
Instruments and  
General Surgical  
Instruments

**Esmarch Plaster Shears**

Catalog#	Description
220-100	8" (202mm)

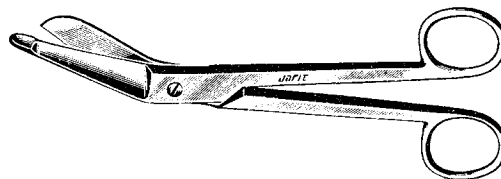

**Bruns Plaster Shears**

Catalog#	Description
220-105	9 1/4" (238mm)

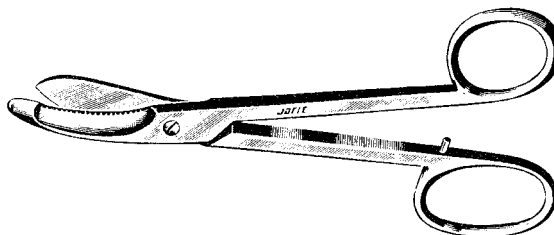

**Hercules Plaster Shears**

Catalog#	Description
220-110	7 1/2" (191mm), eccentric lock

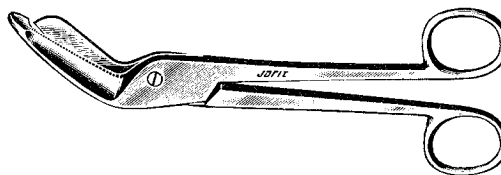

**Plaster and Utility Shears**

Catalog#	Description
220-115	8 1/4" (210mm), notched blade

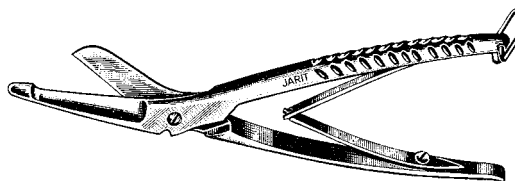

**Universal Bandage Scissors**

one serrated blade, stainless steel with autoclavable plastic finger rings

Catalog #	Description
100-539	5 3/4" (145mm), Black

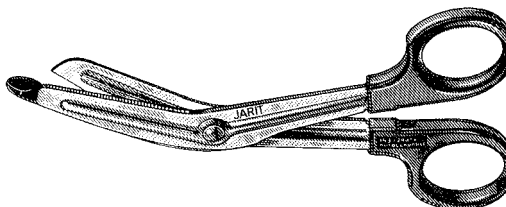

### Universal Bandage Scissors

one serrated blade, stainless steel with autoclavable plastic finger rings

Catalog #	Description
100-540	7½" (190mm), black
100-541	7½" (190mm), red
100-542	7½" (190mm), orange
100-543	7½" (190mm), blue
100-544	7½" (190mm), purple
100-545	7½" (190mm), green
100-546	7½" (190mm), yellow



### Stille Plaster Shears

Catalog#	Description
220-130	15" (380mm)

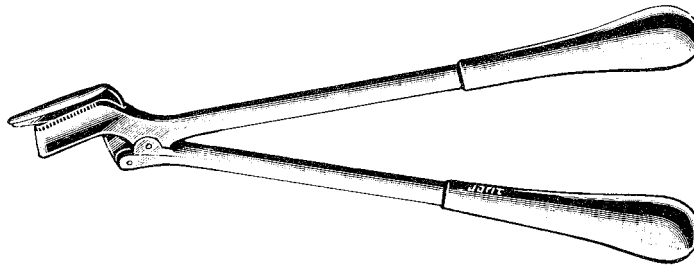

### Wolfe-Boehler Cast Breaker

Catalog#	Description
220-155	10½" (267mm)

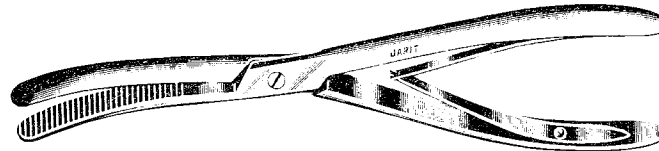

### Hennig Cast Spreader

Catalog#	Description
220-175	11" (280mm)

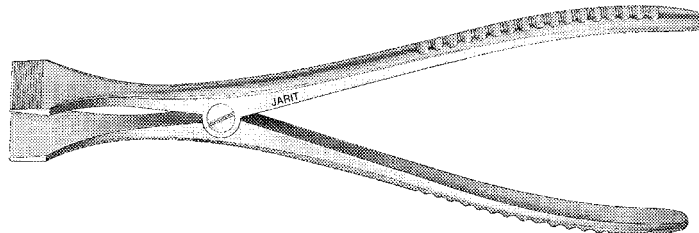

### Walton Cast Spreader

Catalog#	Description
220-180	8¾" (225mm)
220-SPS-180	Replacement Spring and Screw pkg/3ea

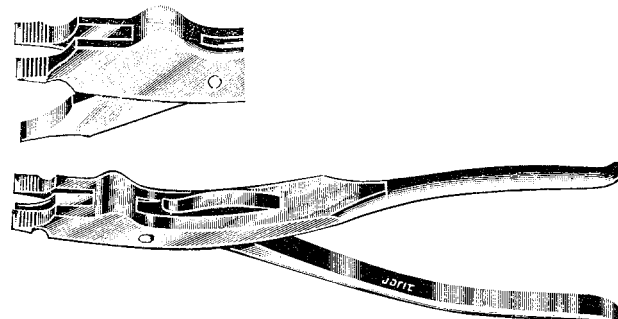

**Kern Bone Holding Clamps**

ratchet

Catalog #	Description
225-105	6½" (163mm)
225-115	9¾" (245mm)
225-SPS-105	Replacement Screw and Spring for Ratchet Mechanism

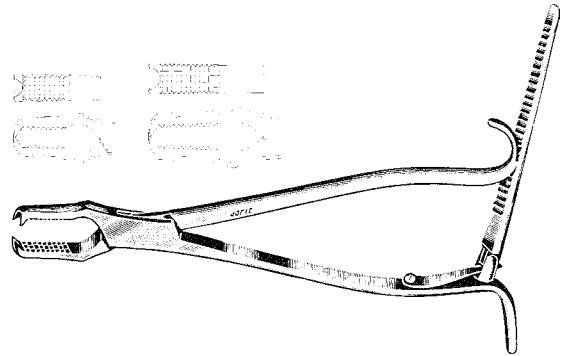

**Lane Bone Holding Clamps**

ratchet

Catalog #	Description
225-121	13" (328mm)
225-126	13" (330mm), heavy model
225-131	16¾" (425mm)

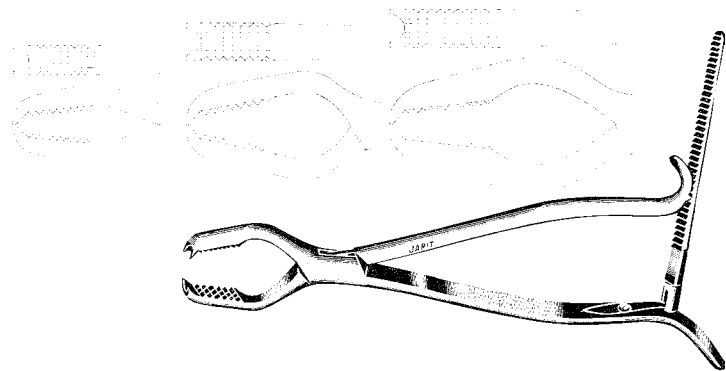

**Bone Reduction Forceps**

speed lock, curved jaws

Catalog #	Description
225-135	6¾" (170mm)
225-136	9¼" (235mm)

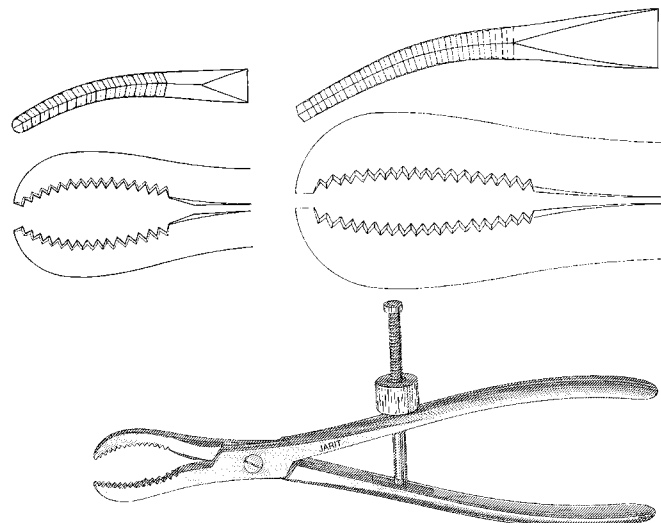

**Bone Reduction Forceps**

curved jaws

Catalog #	Description
225-137	5 <sup>5</sup> / <sub>8</sub> (144mm)

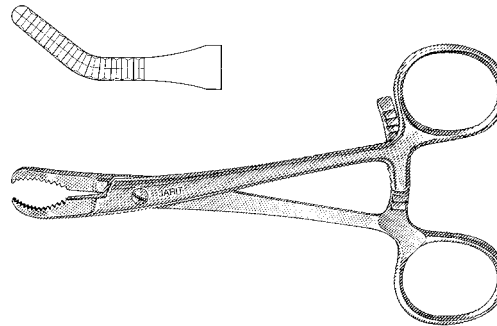

**Bone Reduction Forceps**

Catalog #	Description
225-138	7 <sup>3</sup> / <sub>4</sub> (198mm), 2" (51mm) long ratchet, jaw opening from <sup>3</sup> / <sub>8</sub> " to 4" (9mm x 101mm)

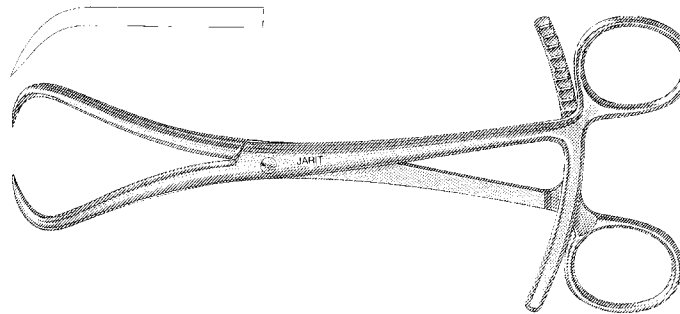

**Bone Reduction Forceps**

curved jaws

Catalog #	Description
225-139	5 <sup>7</sup> / <sub>8</sub> (150mm)

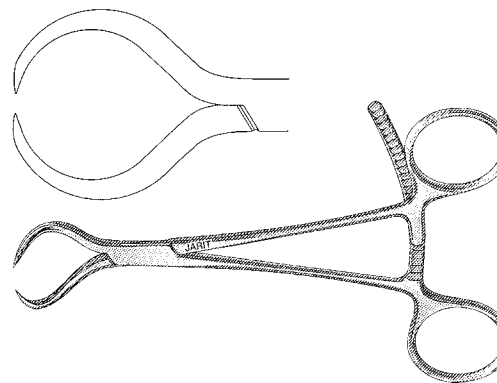

**Lambotte Bone Holding Clamp**

Catalog #	Description
225-162	12" (305mm)

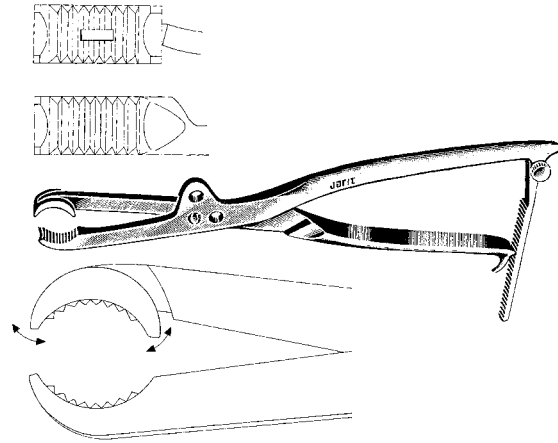

**Farabeuf-Lambotte Bone Holding Clamp**

Catalog #	Description
225-170	10" (257mm)

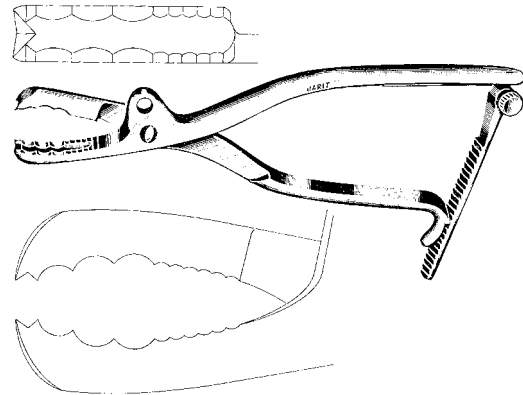

**Lewin Bone Holding Clamp**

Catalog #	Description
225-175	7" (180mm)

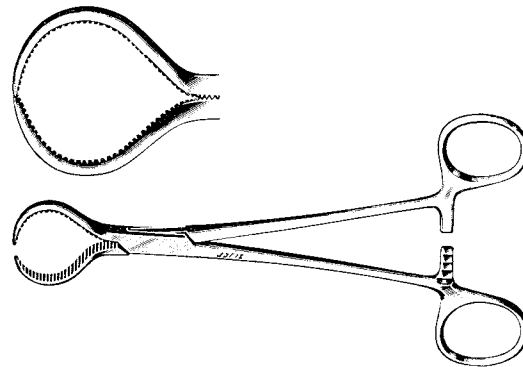



**Self-Centering Bone Forceps**

with speed lock, angled to the side

Catalog#	Description
225-176	5¾" (145mm), for small fragment, 3mm wide jaw
225-177	7¾" (195mm), 8mm wide jaw
225-178	9¾" (246mm), 10mm wide jaw
225-179	10¼" (260mm), 10mm wide jaw
225-180	11" (282mm), 11.7mm wide jaw

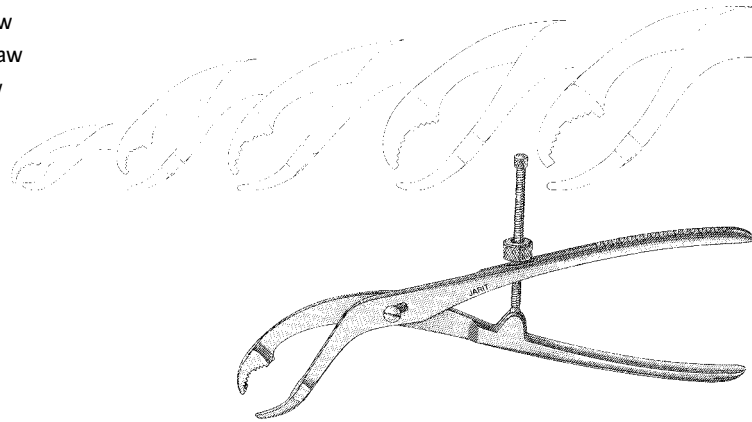

**Verbrugge Bone Holding Clamp**

angled to the side

Catalog #	Description
225-185	7" (175mm) small, 5.2mm wide jaw

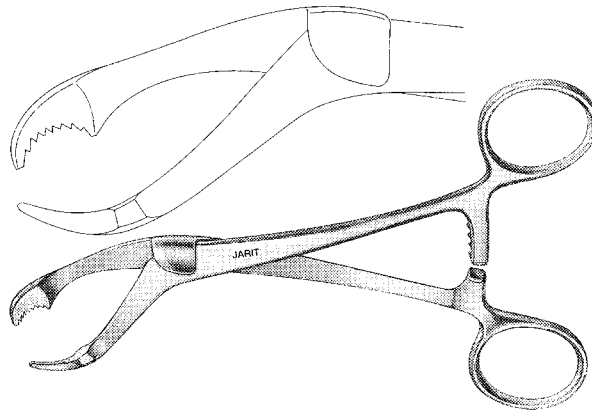

**Verbrugge Bone Holding Clamps**

angled to the side

Catalog #	Description
225-186	10¼" (263mm), 9.5mm wide jaw
225-187	10½" (264mm), 10.5mm wide jaw
225-188	10¾" (271mm), 12mm wide jaw

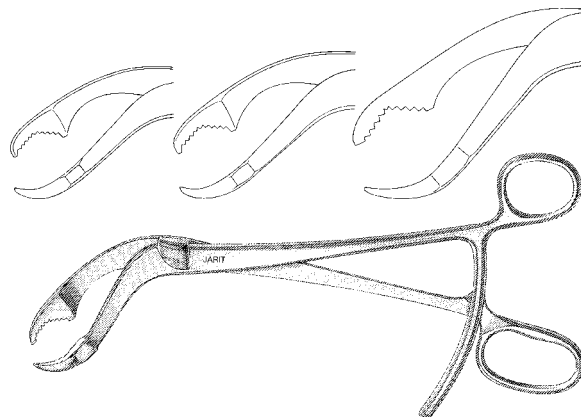

**Ulrich-Style Bone Holding Forceps**  
with speed lock

Catalog#	Description
225-190	7¼" (185mm), 2.9mm wide jaws
225-191	9" (229mm), 9mm wide jaws
225-192	10" (255mm), 9mm wide jaws
225-193	11" (280mm), 9mm wide jaws
225-194	11" (280mm), angled on side, 8.7mm wide jaws

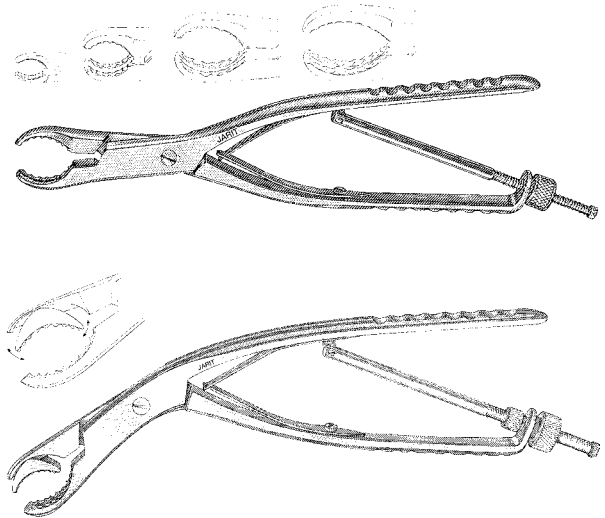

**Lowman Bone Holding Clamps**

1 x 2 prongs

Catalog#	Description
225-200	5¼" (134mm)
225-205	7¼" (184mm)
225-210	8½" (215mm)
225-THB-200	Replacement Threaded Blade
225-THB-205	Replacement Threaded Blade
225-THB-210	Replacement Threaded Blade

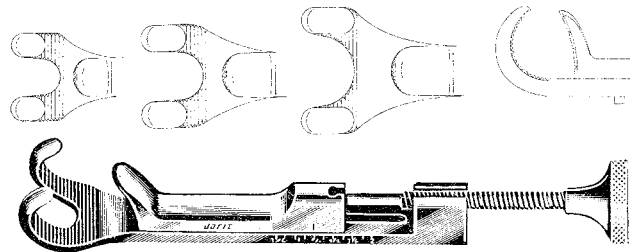

**Lowman Bone Holding Clamps**

1 x 1 prongs

Catalog#	Description
225-215	5¼" (134mm)
225-220	7¼" (184mm)
225-225	8½" (215mm)
225-TRK-225	Replacement Threaded Rod w/Knob

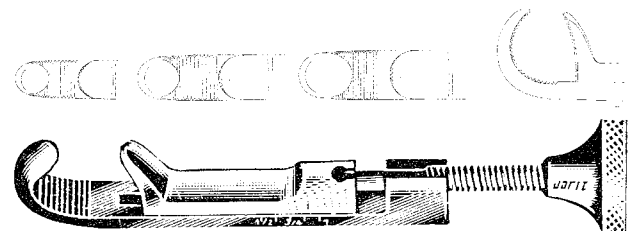

**Lambert-Lowman Bone Holding Clamps**

2 x 2 prongs

Catalog#	Description
225-230	7¼" (184mm)
225-235	8½" (215mm)

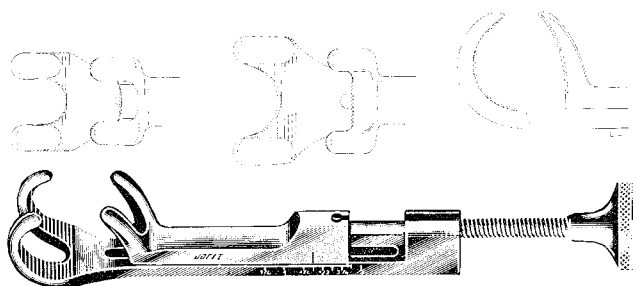

### Bennett Tibia Retractors

Catalog#	Description
225-400	9 <sup>3</sup> / <sub>4</sub> " (245mm), 1 <sup>3</sup> / <sub>4</sub> " (45mm) narrow blade
225-402	9 <sup>3</sup> / <sub>4</sub> " (245mm), 2 <sup>1</sup> / <sub>2</sub> " (62.25mm) wide blade

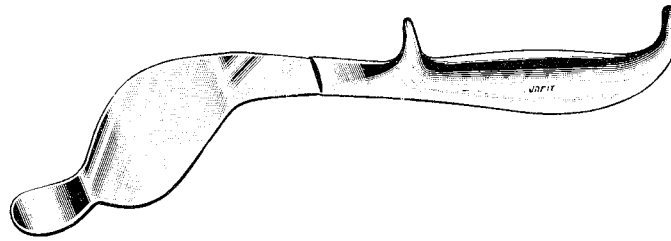

### Blount Knee Retractor

Catalog#	Description
225-405	7" (175mm), 1/4" (7mm) wide blade

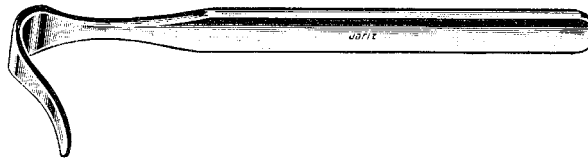

### Blount Retractor

Catalog#	Description
225-407	10 <sup>1</sup> / <sub>4</sub> " (260mm), single prong, 1 <sup>1</sup> / <sub>2</sub> " (38mm) wide blade



### Blount Retractor

Catalog#	Description
225-408	10 <sup>1</sup> / <sub>2</sub> " (265mm), double prong, 1 <sup>5</sup> / <sub>8</sub> " (41mm) wide blade

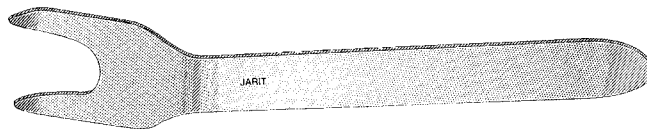

### Liston Amputating Knives

Catalog#	Description
225-412	6 <sup>1</sup> / <sub>4</sub> " (159mm) blade
225-413	8 <sup>1</sup> / <sub>2</sub> " (216mm) blade



### Murphy-Lane Bone Skid

Catalog #	Description
225-420	11 <sup>3</sup> / <sub>4</sub> " (300mm), double-ended <sup>3</sup> / <sub>4</sub> " x 1 <sup>1</sup> / <sub>8</sub> " (18mm x 30mm)

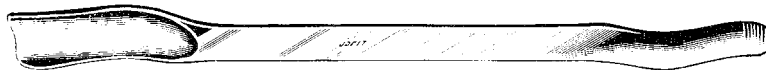

### Meyerding Hip and Shoulder Skid

Catalog #	Description
225-425	13 <sup>1</sup> / <sub>2</sub> " (340mm), blade size 4 <sup>1</sup> / <sub>4</sub> " x 1 <sup>1</sup> / <sub>8</sub> " wide (108mm x 30mm)

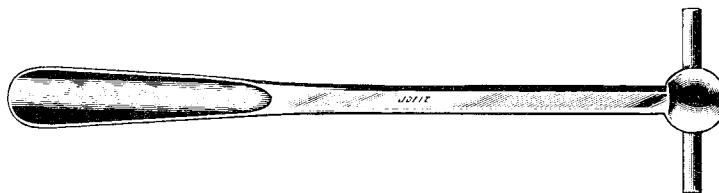

### Smillie Retractors

Catalog #	Description
225-430	5 <sup>3</sup> / <sub>8</sub> " (138mm), reverse curved, <sup>1</sup> / <sub>2</sub> " wide x 2 <sup>1</sup> / <sub>8</sub> " long blade (13mm x 54mm)
225-431	5 <sup>3</sup> / <sub>8</sub> " (138mm), angled, <sup>3</sup> / <sub>4</sub> " wide x 1 <sup>3</sup> / <sub>8</sub> " long blade (19mm x 35mm)
225-432	5 <sup>3</sup> / <sub>8</sub> " (138mm), angled, <sup>3</sup> / <sub>4</sub> " wide x 2" long blade (19mm x 51mm)
225-433	5 <sup>3</sup> / <sub>8</sub> " (138mm), angled, <sup>3</sup> / <sub>4</sub> " wide x 2 <sup>3</sup> / <sub>8</sub> " long blade (19mm x 60mm)
225-434	5 <sup>3</sup> / <sub>8</sub> " (138mm), curved, <sup>1</sup> / <sub>2</sub> " wide x <sup>5</sup> / <sub>8</sub> " long blade (13mm x 16mm)

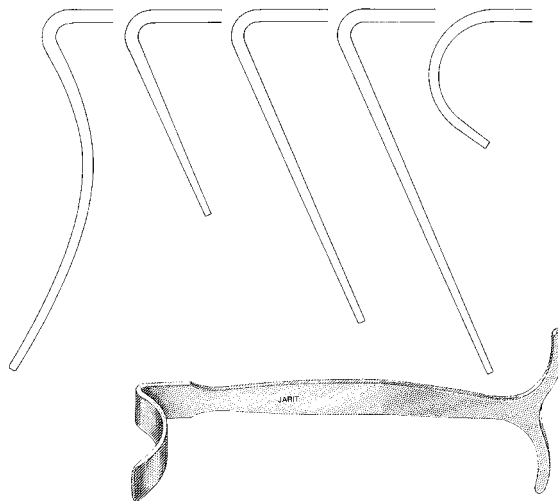

### Hayes Hand Retractors

Catalog #	Description
225-436	5 <sup>1</sup> / <sub>4</sub> " (134mm), blade <sup>1</sup> / <sub>2</sub> " x 1 <sup>1</sup> / <sub>8</sub> " (13mm x 30mm)
225-438	6 <sup>1</sup> / <sub>4</sub> " (160mm), blade <sup>1</sup> / <sub>2</sub> " x 1 <sup>1</sup> / <sub>8</sub> " (13mm x 30mm)

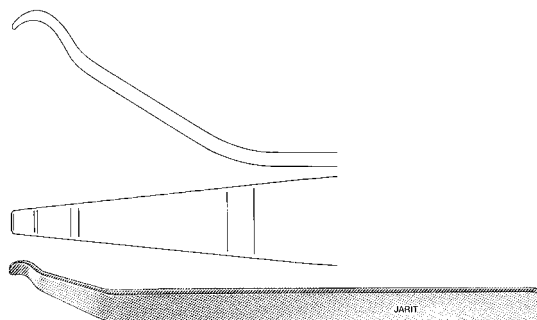

### Mini-Hohmann Retractors

Catalog #	Description
225-440	6½" (164mm), 6mm wide blade
225-441	6½" (164mm), 8mm wide blade

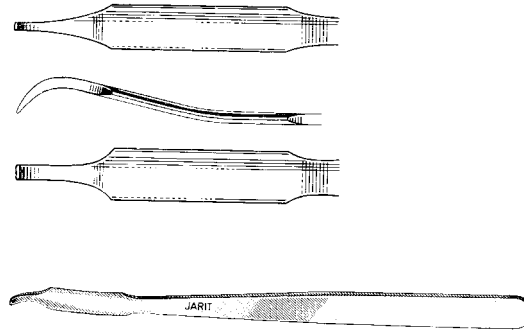

### Hohmann Retractor

Catalog #	Description
225-443	4¾" (160mm), 16mm wide blade

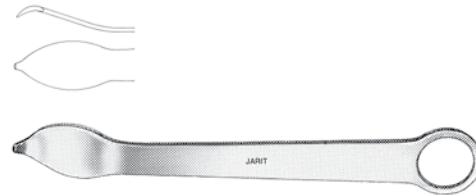

### Hohmann Retractors

6¼" (160mm)

Catalog #	Description
225-444	15mm wide blade



### Hohmann Retractors

Catalog #	Description
225-449	9¼" (235mm), 8mm wide blade
225-450	9¼" (235mm), 10mm wide blade
225-452	9¼" (235mm), 18mm wide blade
225-453	9¼" (235mm), 25mm wide blade
225-454	9¼" (235mm), 43mm wide blade
225-456	9¾" (248mm), 70mm wide blade



### Aufranc Cobra Retractors

Catalog #	Description
225-470	10¼" (260mm), 32mm wide blade, pointed tip, serrated
225-471	10¼" (260mm), 32mm wide blade, blunt tip, serrated
225-472	10¼" (260mm), 32mm wide blade, blunt tip, smooth

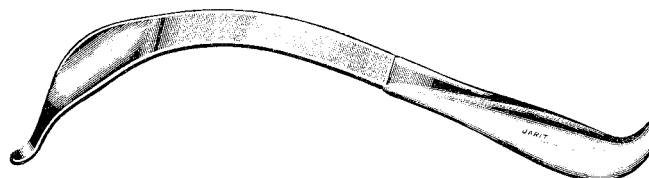

### Deep Rake Retractors w/ Lamb Handles

4 blunt prongs, 2 1/4" (57mm) wide

Catalog#	Description
225-480	10 3/4" (273mm), 1 1/2" deep (38mm)
225-481	10 3/4" (273mm), 2" deep (51mm)
225-482	10 3/4" (273mm), 2 1/2" deep (64mm)
225-483	10 3/4" (273mm), 3" deep (76mm)

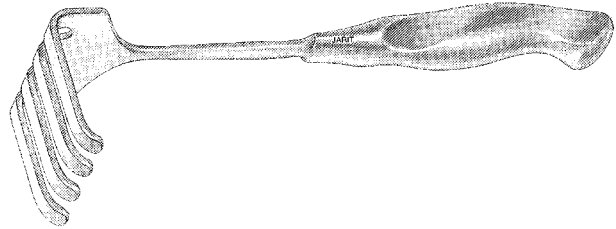

### Initial Incision (Charnley) Retractor Set

Catalog#	Description
225-500	Set Includes: 1 ea. 225-499 frame only, 11 3/4" x 9 1/2" (300mm x 242mm) 1 ea. 225-502 short blade, 1" wide x 1 1/4" deep (25mm x 32mm) 1 ea. 225-503 long blade, 1" wide x 1 1/2" deep (25mm x 38mm) 1 ea. 225-504 weight on chain, stainless steel 3 3/4" x 2 1/8" (95mm x 55mm)
225-499	Frame only: 11 3/4 x 9 1/2 (300mm x 242mm)
225-502	Short blade: 2 3/8" (60mm), 1" wide x 1 1/4" deep (25mm x 32mm)
225-503	Long blade: 6 3/4" (174mm), 1" wide x 1 1/2" deep (25mm x 38mm)
225-501	Short blade: 2 3/8" (60mm), 1" wide x 3" deep (25mm x 76mm)
225-505	Long blade: 6 3/4" (174mm), 1" wide x 3" deep (25mm x 76mm)
225-506	Short blade: 2 3/8" (60mm), 1" wide x 4" deep (25mm x 103mm)
225-507	Long blade: 6 3/4" (174mm), 1" wide x 4" deep (25mm x 103mm)
225-508	Short blade: 2 3/8" (60mm), 1" wide x 5" deep (25mm x 130mm)
225-509	Long blade: 6 3/4" (174mm), 1" wide x 5" deep (25mm x 127mm)
225-504	Weight on chain, stainless steel 3 3/4" x 2 1/8" (95mm x 55mm)
225-CHN-500	Replacement Chain
225-XDB-500	Replacement Extra Deep Blades
225-XDP-500/S	Replacement Retr Blade Deep Short
225-XDP-500/L	Replacement Retr Blade Deep Long

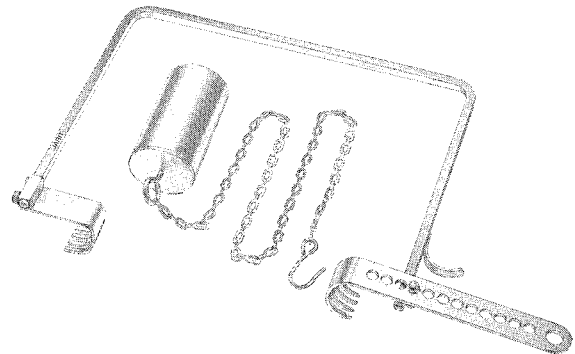

**Horizontal Retractor**

Catalog#	Description
225-510	12" (305mm), 4 x 2 prongs

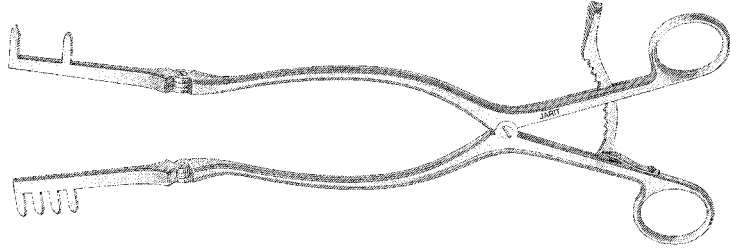

**Vertical Retractor**

Catalog#	Description
225-512	13" (330mm), 3 x 4 prongs

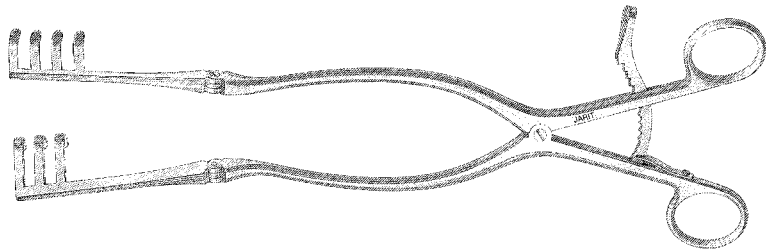

**Lead hand**  
malleable

Catalog#	Description
225-520	Adult 14¾" x 10" (372mm x 255mm)
225-525	Pediatric 10¼" x 7" (260mm x 175mm)

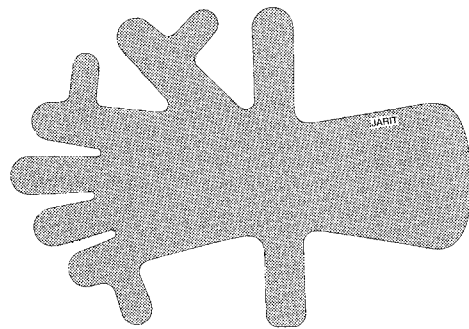

**Blumenthal Rongeurs**

3mm bite

Catalog #	Description
230-097	6" (155mm), 30°
230-095	6" (155mm), 45°
230-096	5¾" (147mm), 90°

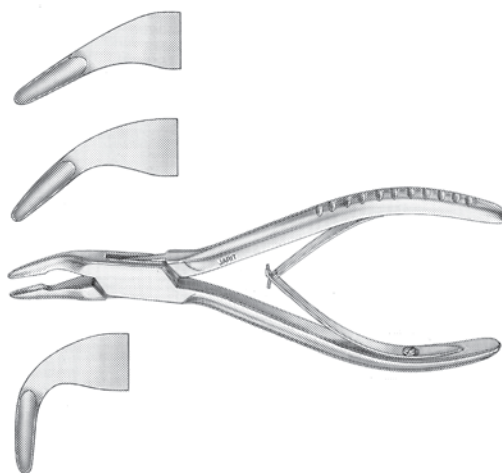

**Micro Friedman Rongeurs**

1.3mm bite

Catalog #	Description
230-093	5½" (140mm), straight

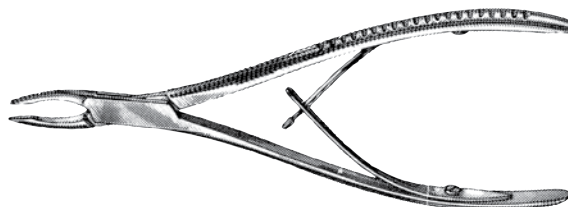

**Micro Friedman Rongeur**

2.4mm bite

Catalog #	Description
230-098	5¼" (132mm), curved
230-099	5⅝" (142mm), curved

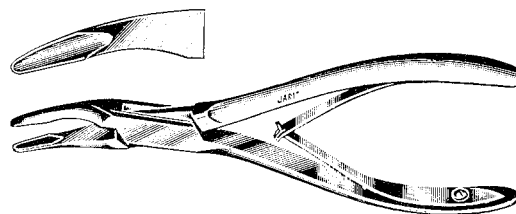

**Luer Rongeurs**

8mm bite

Catalog #	Description
230-100	7¼" (182mm), straight
230-102	7¼" (182mm), curved

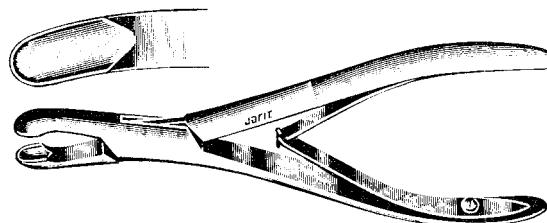



### Shearer Chicken Bill Rongeurs

Catalog #	Description
230-105	5 <sup>5</sup> / <sub>8</sub> " (142mm), strong curve, 5mm bite
230-106	6 <sup>3</sup> / <sub>4</sub> " (170mm), light curve, 4.4mm bite

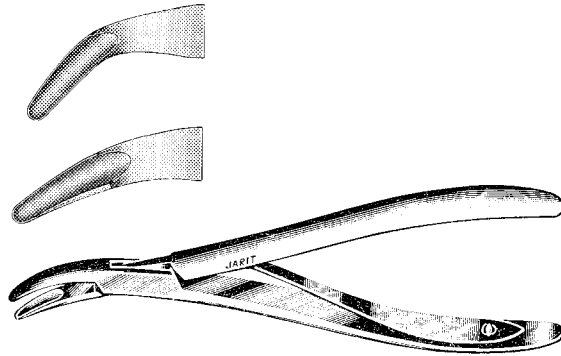

### Reiner Rongeurs

Catalog #	Description
230-110	7" (178mm), 3.2mm bite, light curve
230-111	7" (178mm), 4.2mm bite, light curve
230-112	7" (178mm), 5.8mm bite, light curve

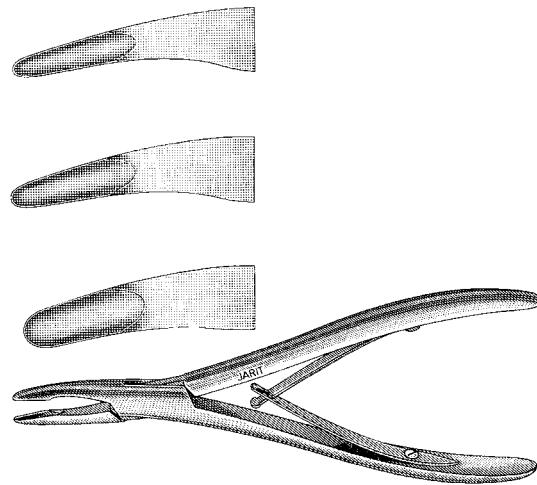

### Hartman Rongeurs

5<sup>7</sup>/<sub>8</sub>" (150mm)

Catalog #	Description
230-120	4.5mm bite, straight, jaw width from 4.5mm to 5.7mm
230-121	4.5mm bite, half curved, jaw width from 4.5mm to 5.4mm
230-122	4.5mm bite, full curved, jaw width from 4.5mm to 5.5mm

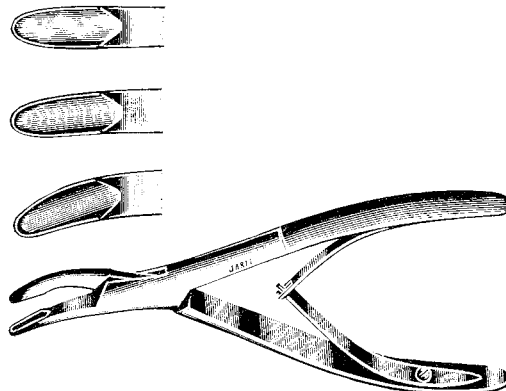

### Bane Rongeurs

Catalog #	Description
230-124	7" (175mm), 4mm bite, curved
230-125	7" (175mm), 5mm bite, curved

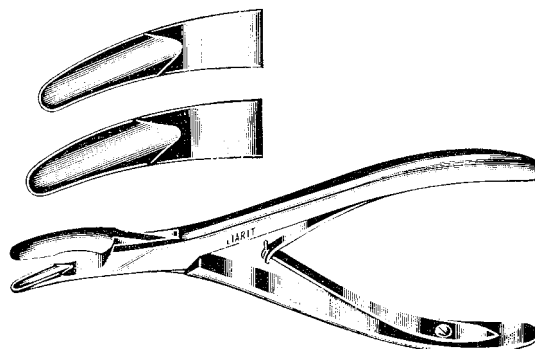

### Lempert Rongeurs

2.5mm bite

Catalog #	Description
230-130	6¼" (158mm), straight
230-131	6¼" (158mm), curved
230-135	7½" (188mm), straight
230-136	7½" (188mm), curved

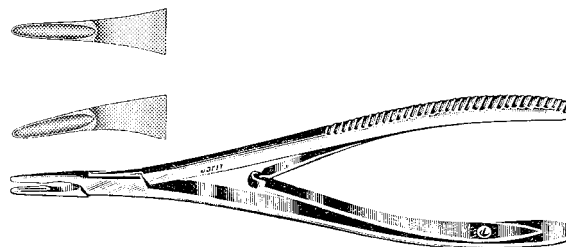

### Juers-Lempert Rongeur

Catalog #	Description
230-138	7¼" (185mm), curved handle, 3mm bite

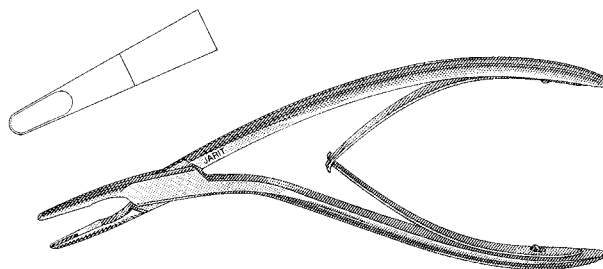

### Dean Rongeur

Catalog #	Description
230-142	5¾" (146mm), 5mm bite, strong curve

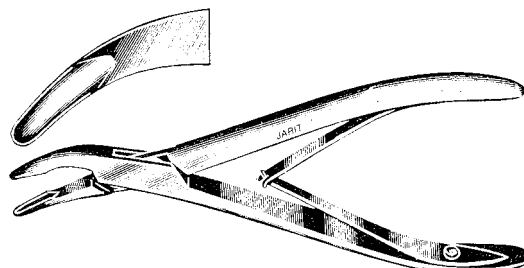

### Cicherelli Rongeur

Catalog #	Description
230-145	6½" (165mm), 3.5mm bite, strong curve

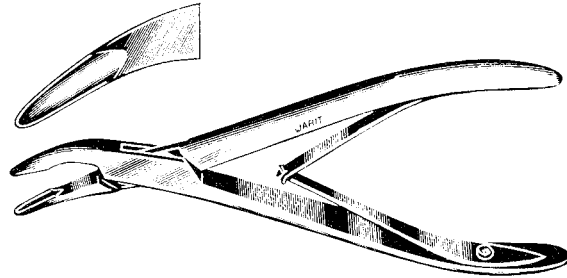

### Adson Rongeurs

Catalog #	Description
230-150	8¼" (212mm), 8mm bite, straight
230-151	8¼" (212mm), 8mm bite, straight, serrated cup jaws

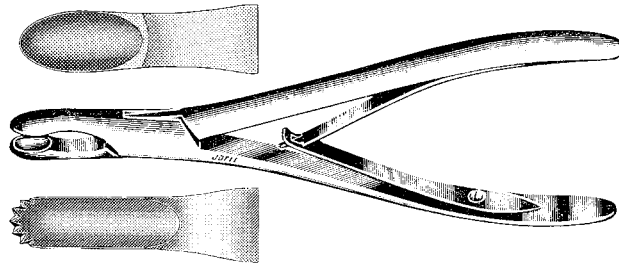

### Cushing Rongeurs

6mm bite

Catalog #	Description
230-160	8" (204mm), straight
230-161	8" (204mm), curved

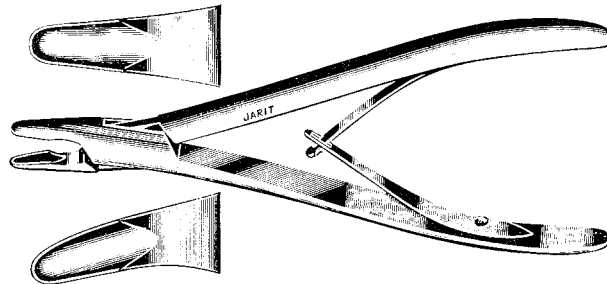

### Ruskin Mini Bone Rongeurs

Catalog #	Description
230-195	6" (155mm), straight, 2mm bite
230-196	6" (155mm), curved, 2mm bite
230-197	6" (155mm), full curved, 3mm bite
230-200	6" (155mm), curved, 4mm bite

230-SPS-196 Replacement Spring and Screw

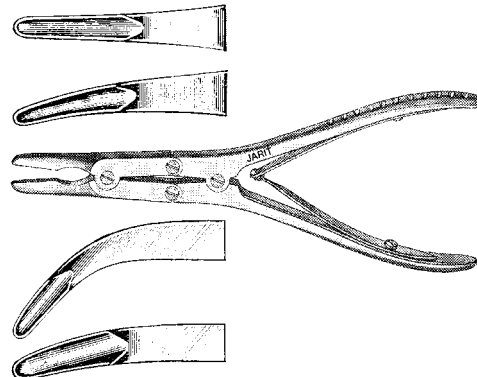

### Beyer Rongeur

Catalog #	Description
230-205	7" (178mm), 3mm bite, light curve
230-SPS-205	Replacement Spring and Screw

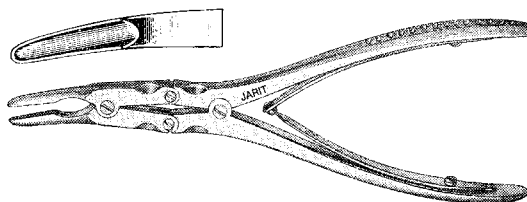

### Jansen-Zaufel Rongeur

Catalog #	Description
230-207	7" (178mm), 4mm bite, light curve
230-SPS-205	Replacement Spring and Screw

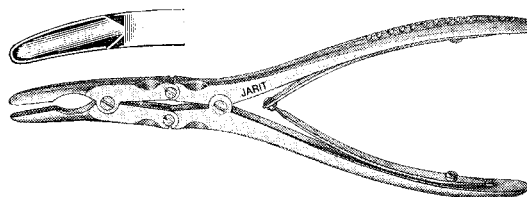

### Ruskin Rongeurs

Catalog #	Description
230-210	7¼" (185mm), straight, 5mm bite
230-211	7¼" (185mm), curved, 5mm bite
230-214	7¼" (185mm), straight, 6mm bite
230-215	7¼" (185mm), curved, 6mm bite
230-SPS-205	Replacement Spring and Screw

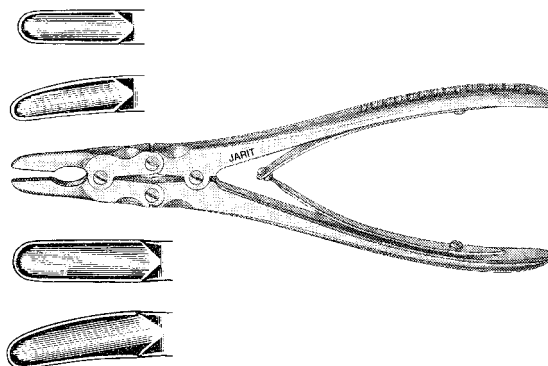

### Ruskin-Jay Rongeur

Catalog #	Description
230-216	8" (202mm), heavy duty, light curved, 6mm bite

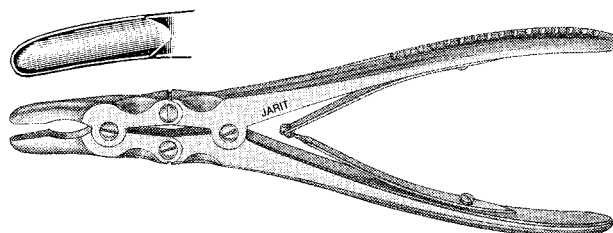

**Ruskin Angular Duckbill Rongeur**

Catalog #	Description
230-218	7¼" (181mm), 6mm bite
230-SPS-205	Replacement Spring and Screw

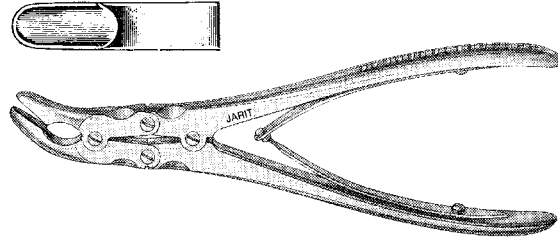

**Stille-Luer Rongeurs**

straight, 10mm bite

Catalog #	Description
230-230	8¾" (222mm)
230-235	10" (255mm)

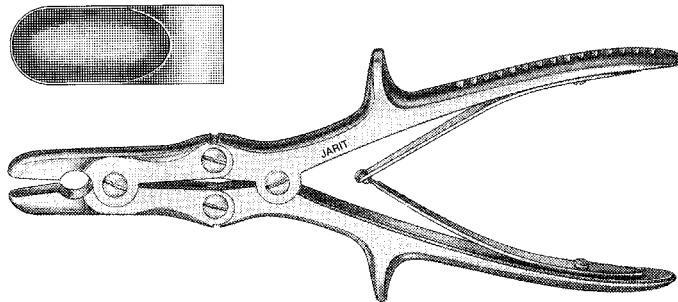

**Stille-Luer Rongeurs**

curved, 10mm bite

Catalog #	Description
230-231	8¾" (222mm)
230-236	10" (255mm)

230-SPS-236 Replacement Spring and Screw

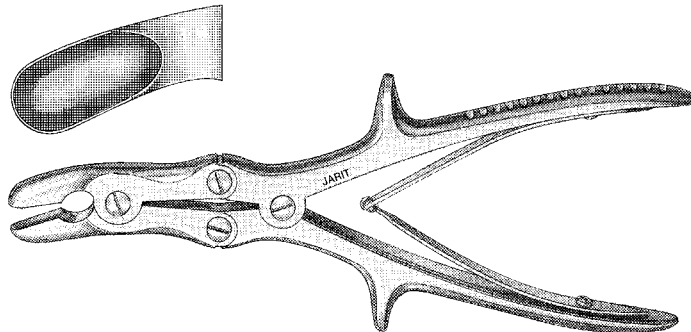

**Stille-Luer Angular Duckbill Rongeurs**

Catalog #	Description
230-240	9" (230mm), 6mm bite

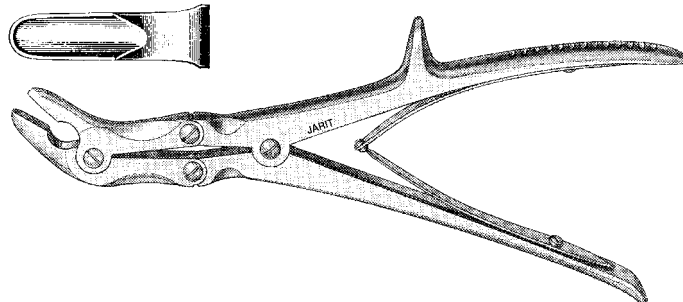

**Echlin Angular Duckbill Rongeurs**

Catalog #	Description
230-245	9" (230mm), 2mm bite
230-246	9" (230mm), 3mm bite
230-247	9" (230mm), 4mm bite
230-SPS-246	Replacement Spring and Screw

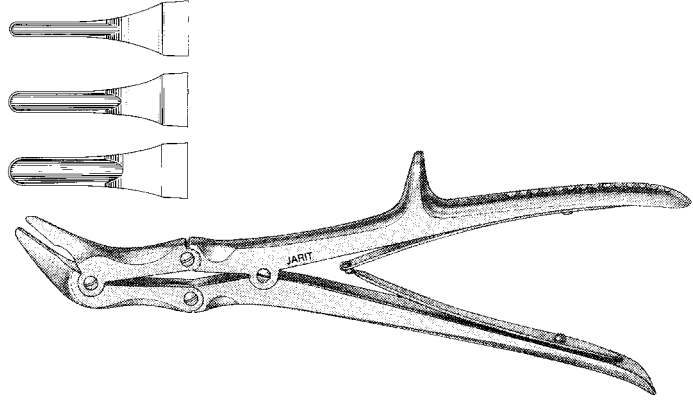

**Stille-Luer-Echlin Angular Duckbill Rongeur**

Catalog #	Description
230-250	9" (230mm), 6mm bite

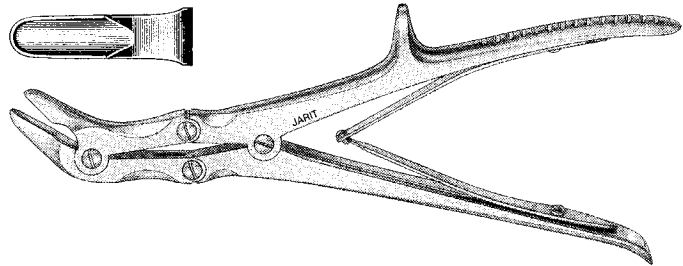

**Leksell Rongeurs**  
slight curve

Catalog #	Description
230-260	9 1/4" (237mm), 3mm bite
230-261	9 1/4" (237mm), 8mm bite
230-262	9 1/4" (237mm), 5mm bite

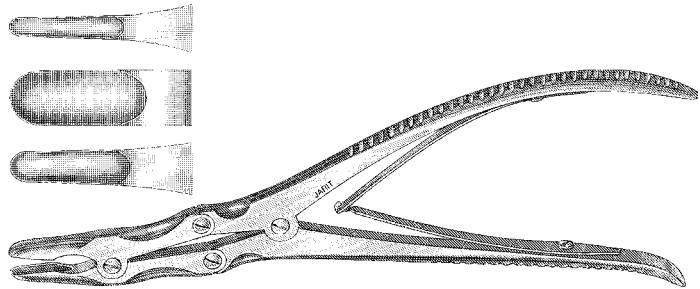

**Leksell Rongeurs**  
full curve

Catalog #	Description
230-265	9 1/4" (237mm), 3mm bite
230-266	9 1/4" (237mm), 8mm bite
230-267	9 1/4" (237mm), 5mm bite

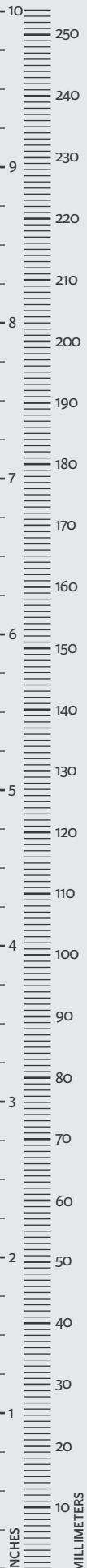
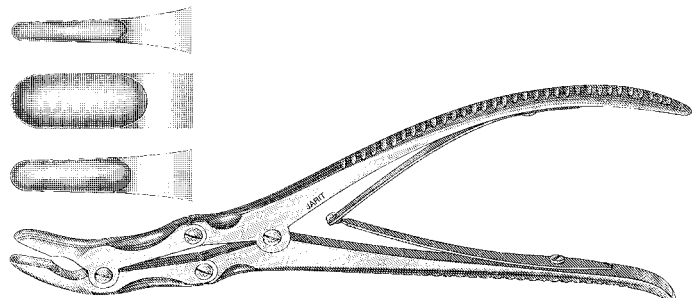

### Smith-Petersen Laminectomy Rongeurs

3.5mm bite

Catalog #	Description
230-270	9½" (240mm), straight
230-271	9½" (240mm), half curved
230-272	9½" (240mm), full curved

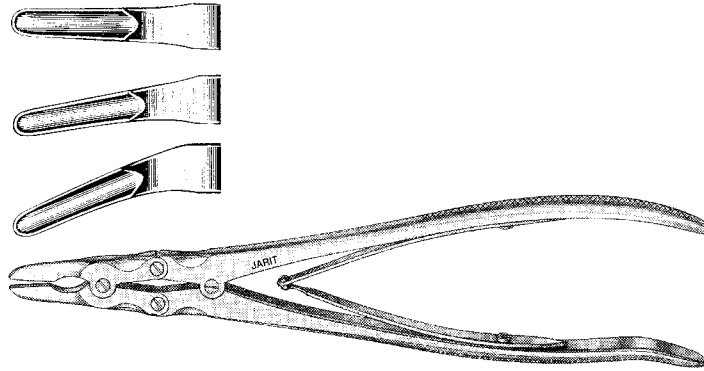

### Sauerbruch Rib Rongeurs

square bite

Catalog #	Description
230-275	12" (305mm), 5/8" (16mm) wide jaw
230-276	12" (305mm), 3/4" (19mm) wide jaw

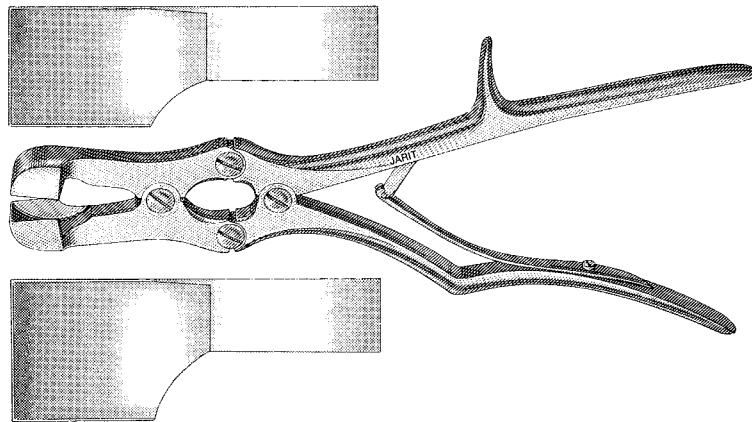

### Dale Thoracic Rongeurs

3mm bite, slight curve

Catalog #	Description
230-280	13½" (343mm)

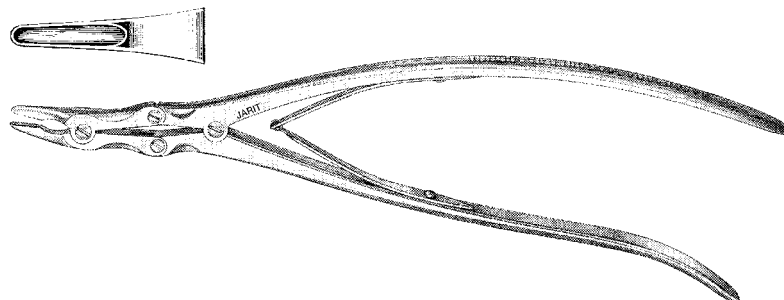

**Walton-Liston Bone Cutting Forceps**

14mm cutting jaws

Catalog #	Description
230-300	5 <sup>5</sup> / <sub>8</sub> " (143mm), straight
230-301	5 <sup>5</sup> / <sub>8</sub> " (143mm), up-angled
230-302	5 <sup>5</sup> / <sub>8</sub> " (143mm), down-curved

230-SPS-300 Replacement Spring and Screws

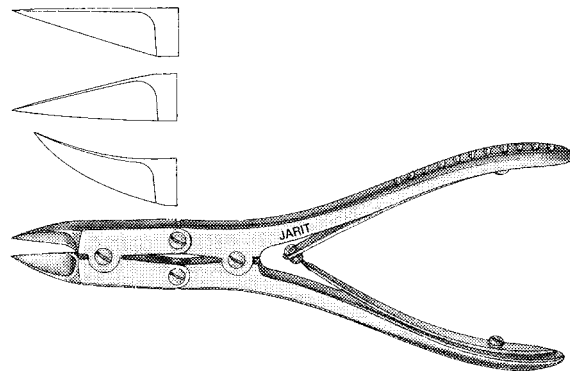

**Ruskin-Liston Bone Cutting Forceps**

22mm cutting jaws

Catalog #	Description
230-305	7 <sup>1</sup> / <sub>4</sub> " (185mm), straight
230-306	7 <sup>1</sup> / <sub>4</sub> " (185mm), up-angled

230-SPS-305 Replacement Spring and Screws

230-SPS-306 Replacement Spring and Screws

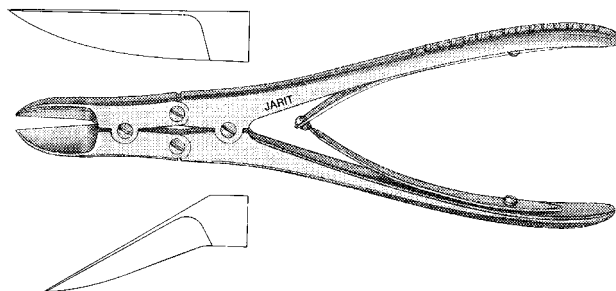

**Ruskin-Liston Bone Splitting Forceps**

14mm cutting jaw, narrow jaw

Catalog #	Description
230-310	7 <sup>1</sup> / <sub>4</sub> " (182mm), straight
230-311	7 <sup>1</sup> / <sub>4</sub> " (182mm), up-angled

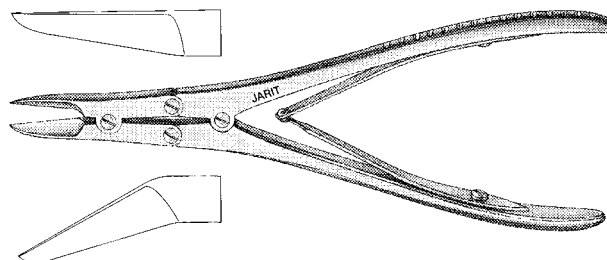

**Littauer-Liston Bone Cutting Forceps**

12mm cutting jaw

Catalog #	Description
230-315	6 <sup>1</sup> / <sub>4</sub> " (158mm), straight

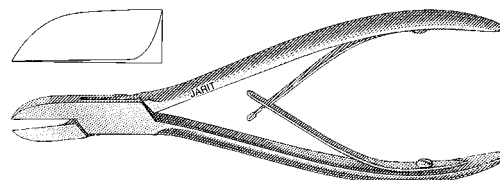



### Stille-Liston Bone Cutting Forceps

Catalog #	Description
230-320	10 <sup>3</sup> / <sub>4</sub> " (270mm), straight, 32.7mm cutting jaws
230-321	10 <sup>3</sup> / <sub>4</sub> " (270mm), up-angled, 27.3mm cutting jaws

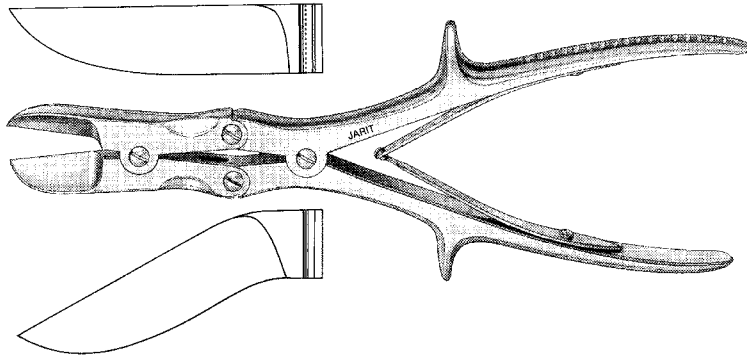

### Stille-Horsley Rongeur

Catalog #	Description
230-325	9 <sup>3</sup> / <sub>4</sub> " (250mm), S-shaped, 25mm cutting edge

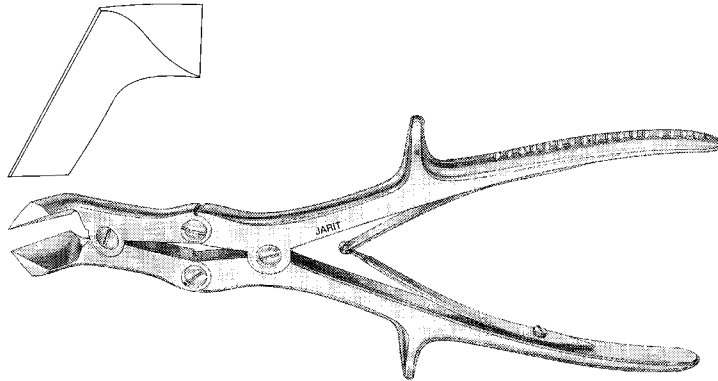

### Liston Bone Cutting Forceps

Catalog #	Description
230-330	5 <sup>3</sup> / <sub>4</sub> " (145mm), straight, 12mm cutting jaws
230-331	6 <sup>1</sup> / <sub>2</sub> " (167mm), straight, 16mm cutting jaws
230-332	7 <sup>1</sup> / <sub>2</sub> " (190mm), straight, 25mm cutting jaws
230-340	5 <sup>3</sup> / <sub>4</sub> " (145mm), up-angled, 12mm cutting jaws
230-341	6 <sup>1</sup> / <sub>2</sub> " (167mm), up-angled, 16mm cutting jaws
230-342	7 <sup>1</sup> / <sub>2</sub> " (190mm), up-angled, 25mm cutting jaws

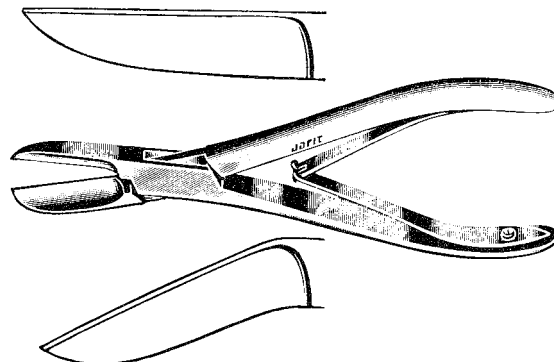

**Bruns Oval Cup Currettes**

7" (175mm), straight

Catalog #	Description
240-098	Size 5-0
240-099	Size 4-0
240-100	Size 3-0
240-101	Size 2-0
240-102	Size 0
240-103	Size 1
240-104	Size 2
240-105	Size 3
240-106	Size 4
240-107	Size 5
240-108	Size 6

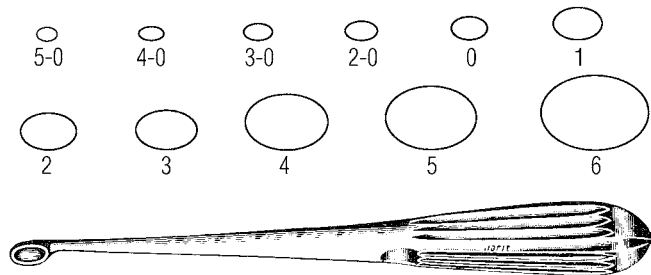

8" (203mm), straight

Catalog #	Description
240-070	Size 5-0
240-071	Size 4-0
240-072	Size 3-0
240-073	Size 2-0
240-074	Size 0
240-075	Size 1
240-076	Size 2
240-077	Size 3
240-078	Size 4
240-079	Size 5
240-080	Size 6

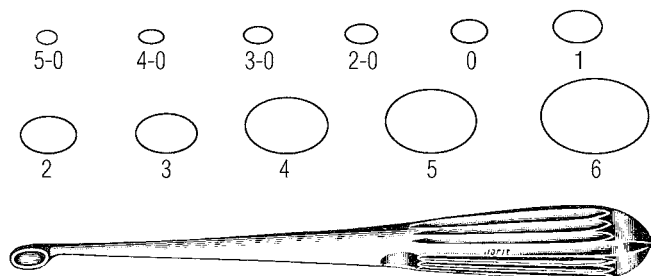

9" (230mm), straight

Catalog #	Description
240-118	Size 5-0
240-119	Size 4-0
240-120	Size 3-0
240-121	Size 2-0
240-122	Size 0
240-123	Size 1
240-124	Size 2
240-125	Size 3
240-126	Size 4
240-127	Size 5
240-128	Size 6

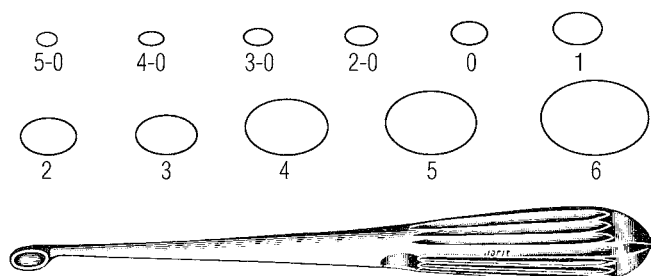

**Bruns Oval Cup Currettes**

8" (203mm), angled tip

Catalog #	Description
240-085	Size 5-0
240-086	Size 4-0
240-087	Size 3-0
240-088	Size 2-0
240-089	Size 0
240-090	Size 1
240-091	Size 2
240-092	Size 3
240-093	Size 4
240-094	Size 5
240-095	Size 6

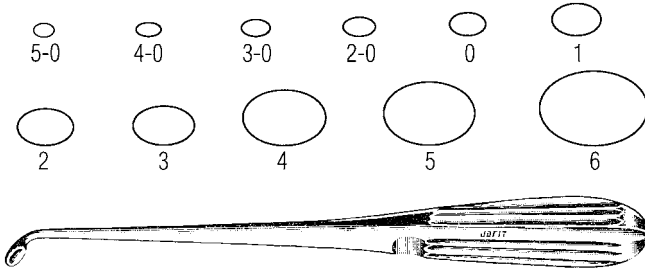

9" (230mm), angled

Catalog #	Description
240-138	Size 5-0
240-139	Size 4-0
240-140	Size 3-0
240-141	Size 2-0
240-142	Size 0
240-143	Size 1
240-144	Size 2
240-145	Size 3
240-146	Size 4
240-147	Size 5
240-148	Size 6

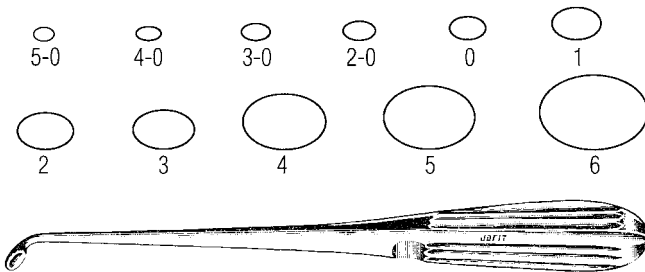

**Spinal Fusion Currettes**

9" (230mm), reverse angle

Catalog #	Description
240-149	Size 5-0
240-150	Size 4-0
240-151	Size 3-0
240-152	Size 2-0
240-153	Size 0
240-154	Size 1
240-155	Size 2
240-156	Size 3
240-157	Size 4
240-158	Size 5
240-159	Size 6

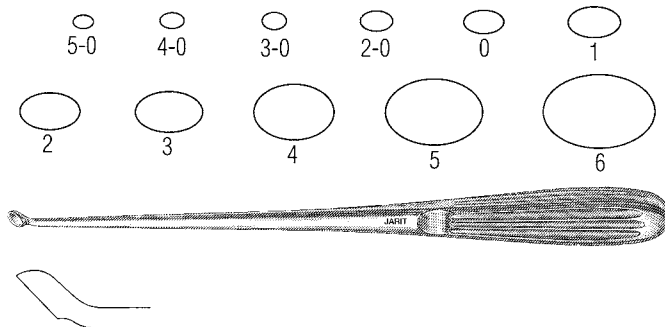

**Bruns Oval Cup Currettes**

straight, solid hexagonal handle

Catalog #	Description
240-160	9" (228mm), Size 3-0
240-161	9" (228mm), Size 2-0
240-162	9" (230mm), Size 0
240-163	9" (230mm), Size 1
240-164	9 1/4" (232mm), Size 2
240-165	9 1/4" (232mm), Size 3
240-166	9 1/4" (232mm), Size 4
240-167	9 1/4" (235mm), Size 5
240-168	9 1/4" (235mm), Size 6

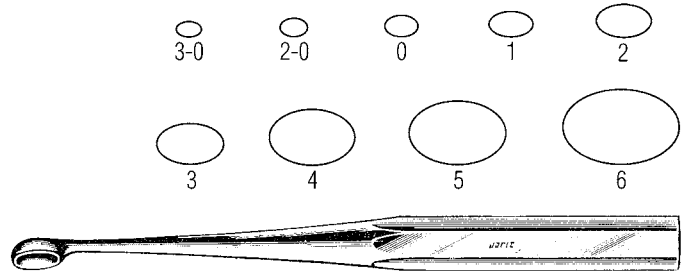

**Semmes (Howard) Spinal Currettes**

9" (228mm), 5 x 7 mm cup

Catalog #	Description
240-170	Straight
240-171	Slight Angle
240-172	Acute Angle

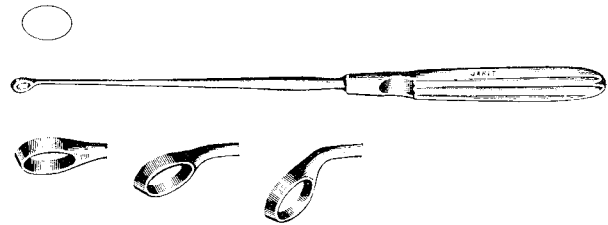

**Cobb-Type Oval Cup Currettes**

11" (280mm), hollow knurled handle, straight

Catalog #	Description
240-175	Size 3-0
240-176	Size 2-0
240-177	Size 0
240-178	Size 1
240-179	Size 2
240-180	Size 3
240-181	Size 4
240-182	Size 5
240-183	Size 6

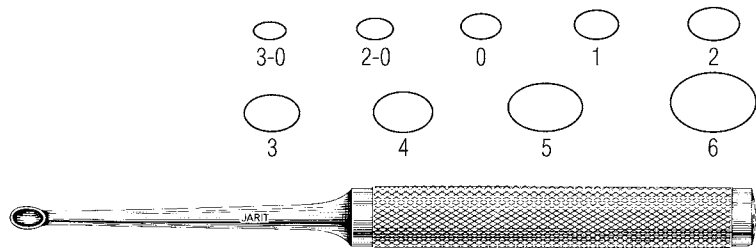

11" (280mm), hollow knurled handle, angled tip

Catalog #	Description
240-185	Size 3-0
240-186	Size 2-0
240-187	Size 0
240-188	Size 1
240-189	Size 2
240-190	Size 3
240-191	Size 4
240-192	Size 5
240-193	Size 6

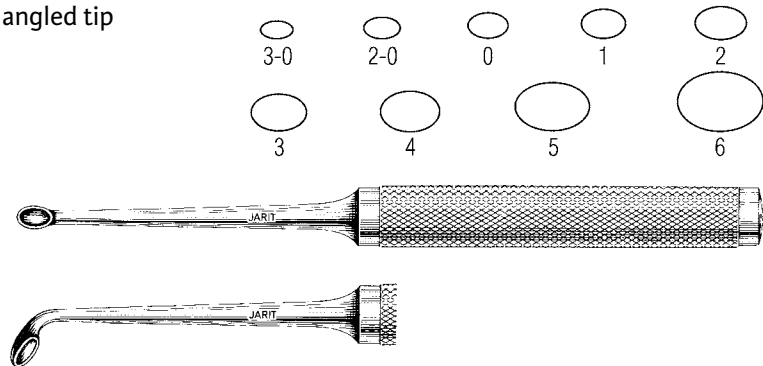

**Bone Hook**

Catalog #	Description
240-195	9" (230mm), 3/8" (9.5mm) hook
240-196	9" (230mm), 3/4" (19mm) hook
240-197	9" (230mm), 1" (25mm) hook

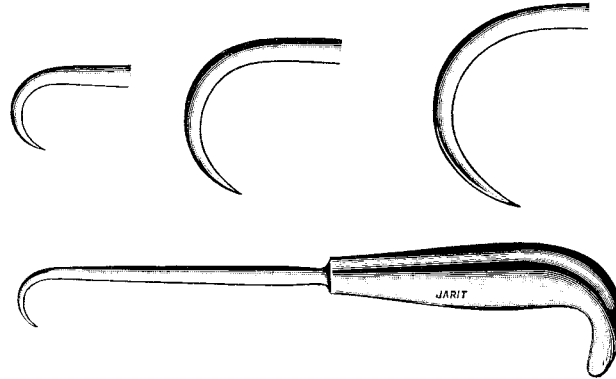

**Boyes-Goodfellow Hooks**

Catalog #	Description
240-198	8 1/4" (214mm), modified points



**Volkman Bone Currettes**

double ended

Catalog #	Description
240-200	5 1/4" (132mm), one round and one oval cup, 10.5mm and 63mm x 68mm
240-202	6 1/2" (167mm), two oval cups, 7.3mm x 13mm and 8.3mm x 22mm
240-203	6 1/2" (167mm), one round and one oval cup, 14mm and 7mm x 9mm
240-205	8" (201mm), one round and one oval cup, 17.5mm and 9mm x 11mm

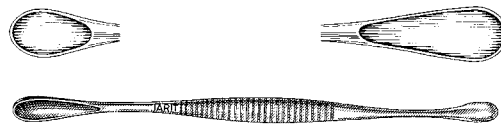

**Scoville Disc Currettes**

4 x 10mm cup

Catalog #	Description
240-207	10" (254mm), straight
240-208	10" (254mm), reverse angled
240-209	10" (254mm), angled

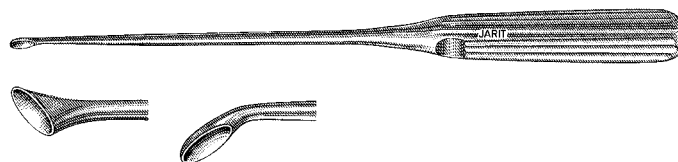

**Cone Ring Currettes**

Catalog #	Description
240-210	9" (229mm), straight, size 1, 8mm diameter
240-211	9" (229mm), straight, size 2, 6mm diameter
240-212	9" (229mm), straight, size 3, 3mm diameter
240-214	9" (229mm), angular, size 1, 8mm diameter
240-215	9" (229mm), angular, size 2, 6mm diameter
240-216	9" (229mm), angular, size 3, 3mm diameter

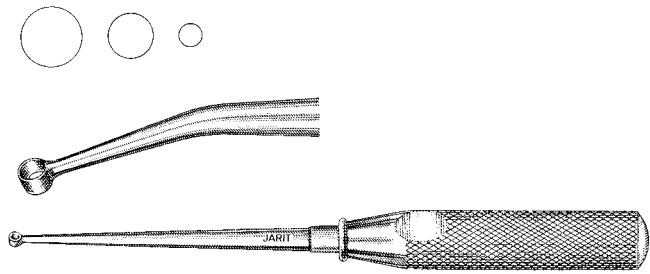

**Cone Ring Currettes**

8mm cup

Catalog #	Description
240-220	9" (229mm), 5° angle
240-221	9" (229mm), 30° angle

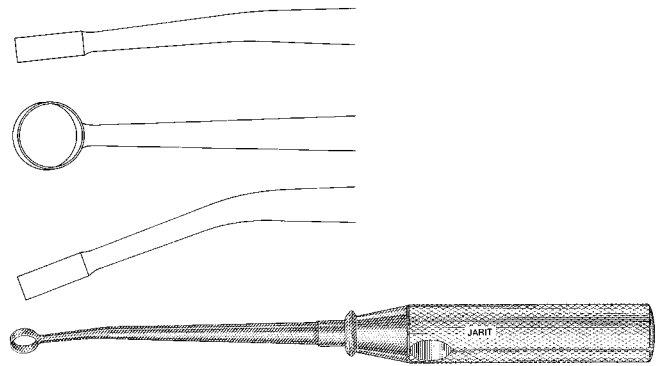

**Epstein Spinal Fusion Currettes**

reverse angle

Catalog #	Description
240-230	7¾" (200mm), size 3-0
240-231	7¾" (200mm), size 2-0
240-232	7¾" (200mm), size 0

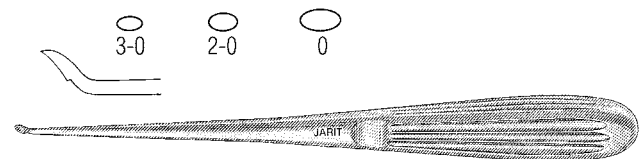

### Lambotte Osteotome Rack

Catalog #	Description
250-090	Stainless steel, holds 12 Jarit Lambotte 9" osteotomes, rack size: 3" x 7 <sup>3</sup> / <sub>8</sub> " x 11 <sup>1</sup> / <sub>8</sub> " (76mm x 187mm x 283mm)

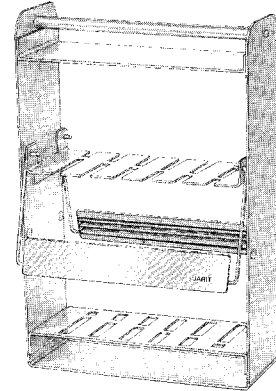

### Hibbs-Bruns Curette Rack

Catalog #	Description
250-092	Stainless steel, holds 12 Jarit 6 <sup>3</sup> / <sub>4</sub> ", 8" and 9" Bruns, curettes, rack size: 2 <sup>1</sup> / <sub>2</sub> " x 7 <sup>3</sup> / <sub>8</sub> " x 11 <sup>1</sup> / <sub>8</sub> " (64mm x 187mm x 283mm)

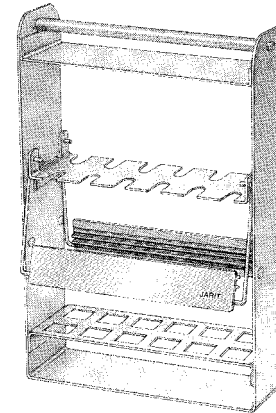

### Hibbs-Bruns Curette Rack

Catalog #	Description
250-084	Stainless steel, holds 12 Jarit 6 <sup>3</sup> / <sub>4</sub> ", 8" and 9" Bruns, curettes, rack size: 2 <sup>1</sup> / <sub>2</sub> " x 9" x 12 <sup>1</sup> / <sub>2</sub> " (64mm x 231mm x 305mm)

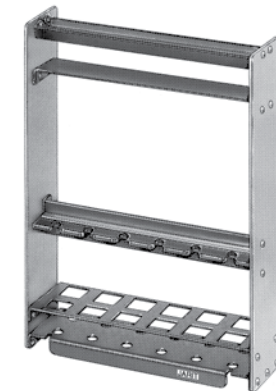

### Bruns Curette Rack

Catalog #	Description
250-093	Stainless steel, holds 12 Jarit Bruns 6 <sup>3</sup> / <sub>4</sub> " curettes, rack size: 2 <sup>1</sup> / <sub>2</sub> " x 7 <sup>3</sup> / <sub>8</sub> " x 9 <sup>1</sup> / <sub>4</sub> " (64mm x 187mm x 235mm)

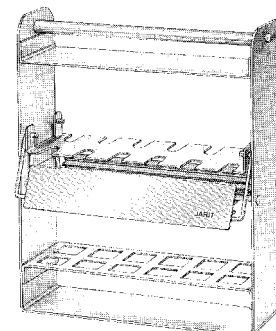

### Smith-Petersen Osteotome Rack

Catalog #	Description
250-095	Stainless steel, holds 7 Jarit Smith-Petersen 8" gouges, osteotomes, rack size: 2" x 10 <sup>5</sup> / <sub>8</sub> " x 9 <sup>7</sup> / <sub>8</sub> " (51mm x 270mm x 251mm)

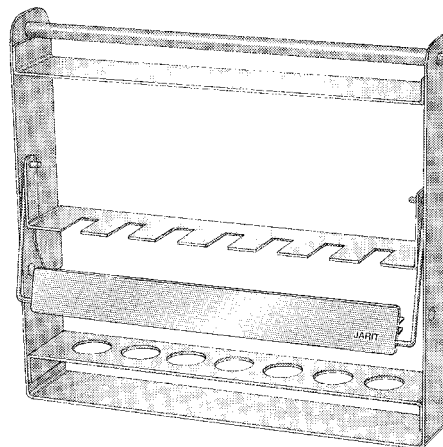

### Cobb Type Instrument Rack

Catalog #	Description
250-097	Stainless steel, holds 9 Jarit Cobb-type 11" instruments, rack size: 1 <sup>3</sup> / <sub>4</sub> " x 14" x 13 <sup>1</sup> / <sub>4</sub> " (44mm x 356mm x 337mm)

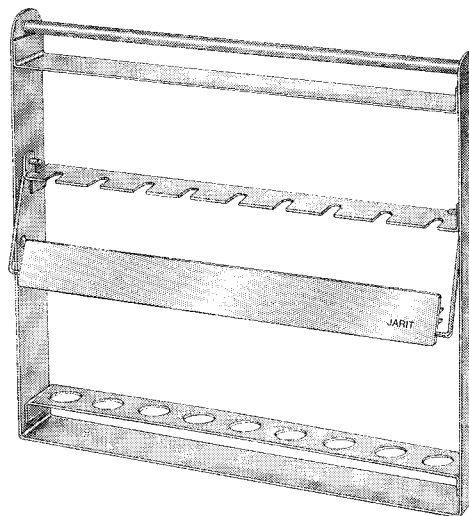

### Hoke Osteotome Rack

Catalog #	Description
250-099	Stainless steel, holds 6 Jarit Hoke 5" osteotomes, rack size: 1 <sup>1</sup> / <sub>2</sub> " x 5 <sup>3</sup> / <sub>4</sub> " x 7" (38mm x 146mm x 178mm)

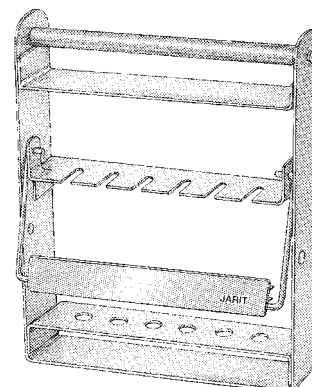



### Hibbs Chisels

9<sup>3</sup>/<sub>4</sub>" (245mm), straight

Catalog #	Description
250-100	1/4" (6mm)
250-101	3/8" (9mm)
250-102	1/2" (12mm)
250-103	5/8" (16mm)
250-104	3/4" (19mm)
250-105	7/8" (22mm)
250-106	1" (25mm)
250-107	1 1/8" (29mm)
250-108	1 1/4" (32mm)
250-109	1 1/2" (38mm)



### Hibbs Chisels

9<sup>3</sup>/<sub>4</sub>" (245mm), curved

Catalog #	Description
250-120	1/4" (6mm)
250-121	3/8" (9mm)
250-122	1/2" (12mm)
250-123	5/8" (16mm)
250-124	3/4" (19mm)
250-125	7/8" (22mm)
250-126	1" (25mm)
250-127	1 1/8" (29mm)
250-128	1 1/4" (32mm)
250-129	1 1/2" (38mm)



### Hibbs Osteotomes

9 1/2" (241mm), straight

Catalog #	Description
250-140	1/4" (6mm)
250-141	3/8" (9mm)
250-142	1/2" (12mm)
250-143	5/8" (16mm)
250-144	3/4" (19mm)
250-145	7/8" (22mm)
250-146	1" (25mm)
250-147	1 1/8" (29mm)
250-148	1 1/4" (32mm)
250-149	1 1/2" (38mm)



### Hibbs Osteotomes

9 1/2" (241mm), curved

Catalog #	Description
250-160	1/4" (6mm)
250-161	3/8" (9mm)
250-162	1/2" (12mm)
250-163	5/8" (16mm)
250-164	3/4" (19mm)
250-165	7/8" (22mm)
250-166	1" (25mm)
250-167	1 1/8" (29mm)
250-168	1 1/4" (32mm)
250-169	1 1/2" (38mm)



### Hibbs Gouges

9 1/2" (241mm), straight

Catalog #	Description
250-180	1/4" (6mm)
250-181	3/8" (9mm)
250-182	1/2" (12mm)
250-183	5/8" (16mm)
250-184	3/4" (19mm)
250-185	7/8" (22mm)
250-186	1" (25mm)
250-187	1 1/8" (29mm)
250-188	1 1/4" (32mm)
250-189	1 1/2" (38mm)



### Hibbs Gouges

9 1/2" (241mm), curved

Catalog #	Description
250-190	1/4" (6mm)
250-191	3/8" (9mm)
250-192	1/2" (12mm)
250-193	5/8" (16mm)
250-194	3/4" (19mm)
250-195	7/8" (22mm)
250-196	1" (25mm)
250-197	1 1/8" (29mm)
250-198	1 1/4" (32mm)
250-199	1 1/2" (38mm)



**Smith-Petersen Osteotomes**

8" (203mm), straight

Catalog #	Description
250-200	1/4" (6mm)
250-201	3/8" (9mm)
250-202	1/2" (12mm)
250-203	5/8" (16mm)
250-204	3/4" (19mm)
250-205	1" (25mm)
250-206	1 1/4" (32mm)

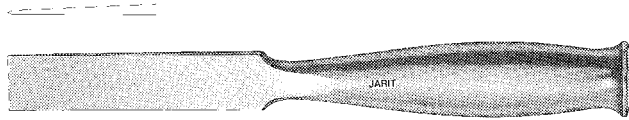

**Smith-Petersen Osteotomes**

8" (201mm), curved

Catalog #	Description
250-210	1/4" (6mm)
250-211	3/8" (9mm)
250-212	1/2" (12mm)
250-213	5/8" (16mm)
250-214	3/4" (19mm)
250-215	1" (25mm)
250-216	1 1/4" (32mm)

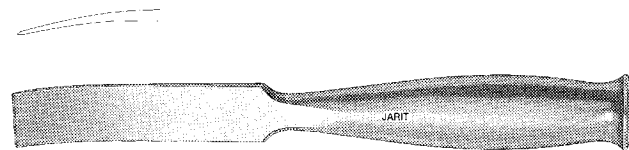

**Smith-Petersen Gouges**

8" (201mm), straight

Catalog #	Description
250-220	1/4" (6mm)
250-221	3/8" (9mm)
250-222	1/2" (12mm)
250-223	5/8" (16mm)
250-224	3/4" (19mm)
250-225	1" (25mm)
250-226	1 1/4" (32mm)

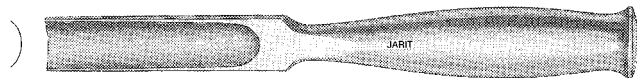

**Smith-Petersen Gouges**

8" (201mm), curved

Catalog #	Description
250-230	1/4" (6mm)
250-231	3/8" (9mm)
250-232	1/2" (12mm)
250-233	5/8" (16mm)
250-234	3/4" (19mm)
250-235	1" (25mm)
250-236	1 1/4" (32mm)

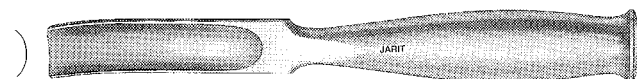

### Cobb-Type Spinal Gouges

11" (280mm), round knurled handle,  
9/32" (7.5mm) wide

Catalog #	Description
250-240	Straight
250-241	Medium curved
250-242	Strong curved
250-243	Reverse curved

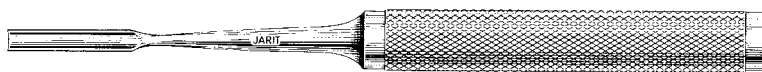
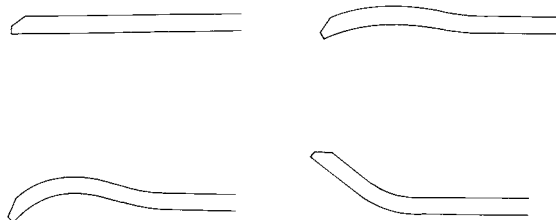

### Cobb-Type Spinal Gouges

9 1/4" (235mm), solid hexagonal handle,  
5/16" (8mm) wide

Catalog #	Description
251-240	Straight
251-241	Medium curved
251-242	Strong curved
251-243	Reverse curved

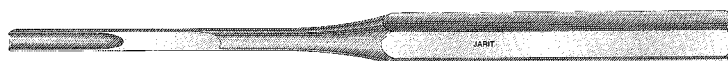
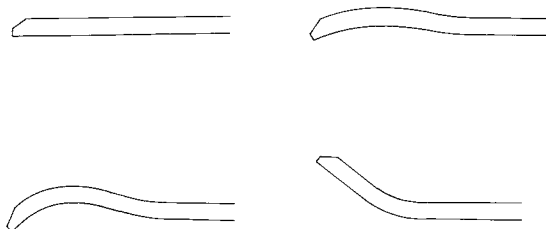

### Cobb-Type Spinal Elevators

round knurled handle

Catalog #	Description
250-244	11" (280mm), 3/8" (9mm) blade
250-245	11" (280mm), 1/2" (12mm) blade
250-246	11" (280mm), 3/4" (19mm) blade
250-247	11" (280mm), 1" (25mm) blade
250-248	11" (280mm), 1 1/4" (32mm) blade

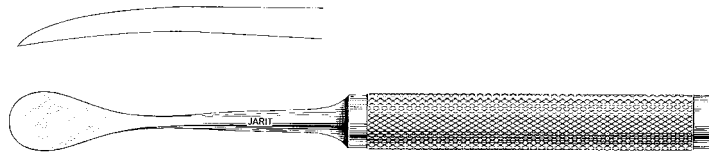

### Cobb-Type Spinal Elevators

solid hexagonal handle

Catalog #	Description
251-244	9 1/2" (240mm), 3/8" (9mm) blade
251-245	9 1/2" (240mm), 1/2" (12.5mm) blade
251-246	9 1/2" (240mm), 3/4" (19mm) blade

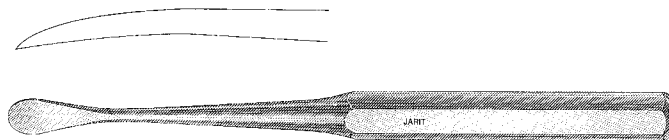

### Lambotte Osteotomes

9" (229mm), straight

Catalog #	Description
250-250	1/4" (6mm)
250-251	1/2" (12mm)
250-252	3/4" (19mm)
250-253	1" (25mm)
250-254	1 1/4" (32mm)
250-255	1 1/2" (38mm)

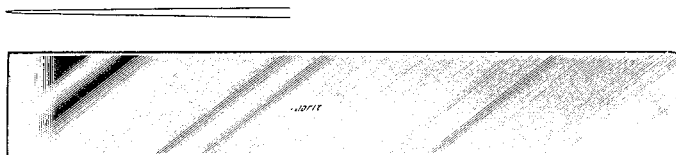

### Lambotte Osteotomes

9" (229mm), curved

Catalog #	Description
250-260	1/4" (6mm)
250-261	1/2" (12mm)
250-262	3/4" (19mm)
250-263	1" (25mm)
250-264	1 1/4" (32mm)
250-265	1 1/2" (38mm)

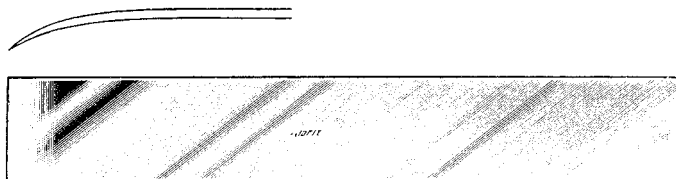

### Hoke Osteotomes

5 1/2" (140mm), straight

Catalog #	Description
250-280	1/8" (3mm)
250-281	3/16" (5mm)
250-282	1/4" (6mm)
250-283	5/16" (8mm)
250-284	3/8" (9mm)
250-285	1/2" (12mm)
250-286	5/8" (16mm)

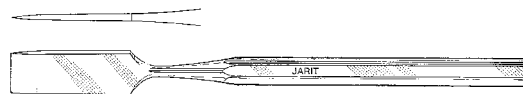

### Hoke Osteotomes

5 1/2" (140mm), curved

Catalog #	Description
250-290	1/8" (3mm)
250-291	3/16" (5mm)
250-292	1/4" (6mm)
250-293	5/16" (8mm)
250-294	3/8" (9mm)
250-295	1/2" (12mm)
250-296	5/8" (16mm)

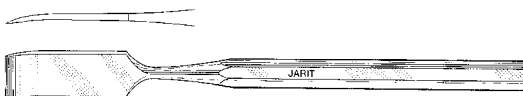

### Bone Awl

Catalog #	Description
275-563	5¾" (146mm)

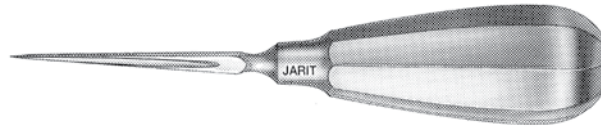

### Stille-Type Osteotomes

Catalog #	Description
250-320	8" (204mm), ⅜" (10mm)
250-321	8" (204mm), 9/16" (14mm)
250-322	8" (204mm), 11/16" (18mm)
250-323	8" (204mm), 7/8" (22mm)

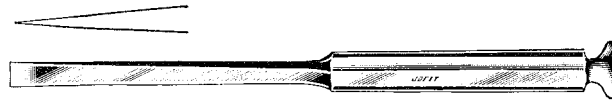

### Stille-Type Gouges

Catalog #	Description
250-330	7¾" (200mm), ⅜" (10mm)
250-331	7¾" (200mm), 9/16" (14mm)
250-332	7¾" (200mm), 11/16" (18mm)
250-333	7¾" (200mm), 7/8" (22mm)



### Stille-Type Chisels

Catalog #	Description
250-335	8" (204mm), ⅜" (10mm)
250-336	8" (204mm), 9/16" (14mm)
250-337	8" (204mm), 11/16" (18mm)
250-338	8" (204mm), 7/8" (22mm)

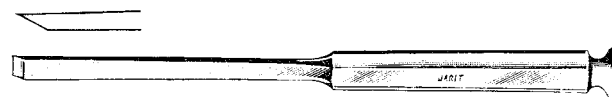

### Lambotte Mini Osteotome Set

Catalog #	Description
250-390	Includes: 7 straight osteotomes, 5" (127mm) long, 2mm, 4mm, 6mm, 8mm, 10mm, 12mm, 14mm wide, nylon capped mallet in canvas roll
250-CVB-390	Canvas Bag

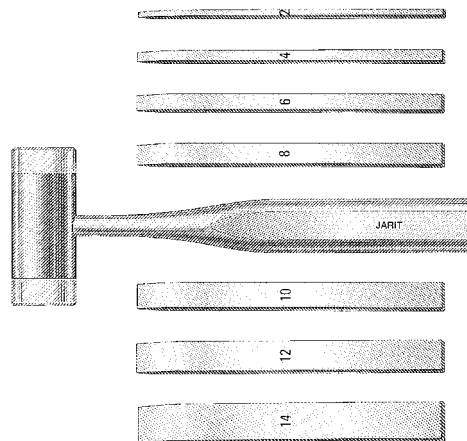

### Lambotte Mini Osteotome Rack (Metal)

Catalog #	Description
250-380	5 1/2" x 6 1/2" x 1/2" (140mm x 165mm x 13mm), holds up to 9 assorted mini osteotomes 2mm to 20mm



### Lambotte Mini Osteotomes

5" (127mm), curved

Catalog #	Description
250-381	1/16" (2mm)
250-382	5/32" (4mm)
250-383	1/4" (6mm)
250-384	5/16" (8mm)
250-385	3/8" (10mm)
250-386	1/2" (12mm)
250-387	9/16" (14mm)

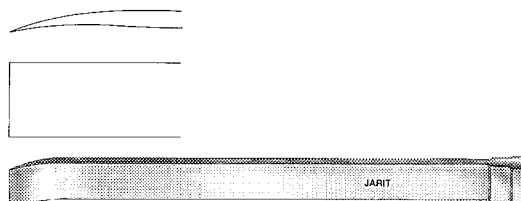



**Lambotte Mini Osteotomes**

5" (127mm), straight

Catalog #	Description
250-391	1/16" (2mm)
250-392	5/32" (4mm)
250-393	1/4" (6mm)
250-394	5/16" (8mm)
250-395	3/8" (10mm)
250-396	1/2" (12mm)
250-397	9/16" (14mm)

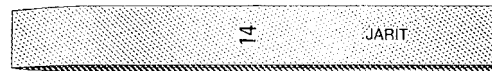

**Mallet w/Nylon Head**

7 1/4" (187mm), anodized aluminum handle

Catalog #	Description
250-398	2 replaceable nylon caps, head: weight 4 oz., diameter 1" (25mm)
250-399	1 replaceable nylon cap and 1 stainless facing, head: weight 5 oz., diameter 1" (25mm)
250-410	Nylon cap for 250-398 and 250-399

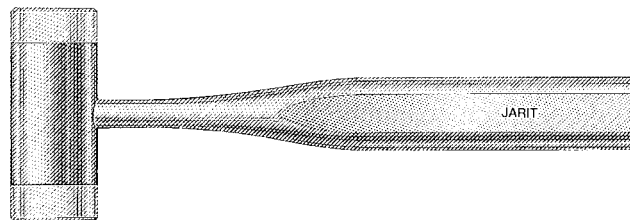

**Kirk Mallet**

Catalog #	Description
250-400	7¾" (197mm) bronze head, head: weight 1 lb. 2 oz., diameter 1⅝" (41mm)

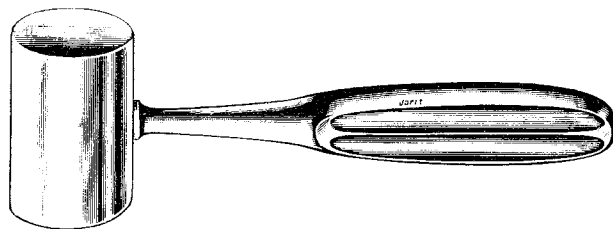

**Orthopedic Mallet**

Catalog #	Description
250-403	7¼" (183mm), head: weight 1 lb., diameter 1¼" (30mm)
250-404	7½" (193mm), head: weight 2 lbs., diameter 1½" (38mm)

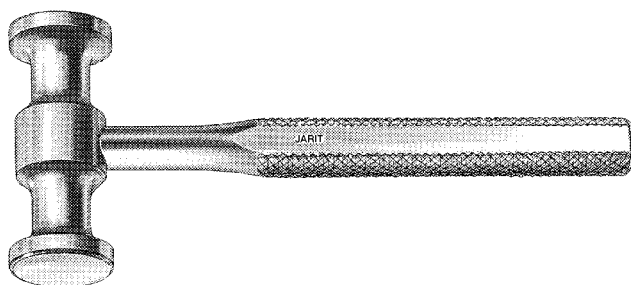

**Bone Mallet**

Catalog #	Description
250-405	11" (280mm), lightweight, head: weight 1 lb., diameter 1⅜" (35mm)

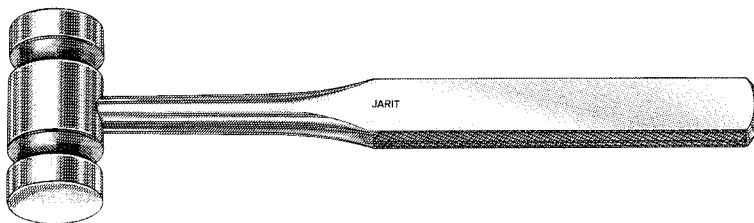

**Bone Mallet**

Catalog #	Description
250-406	11" (280mm), heavyweight, head: weight 2 lbs., diameter 2" (50mm)

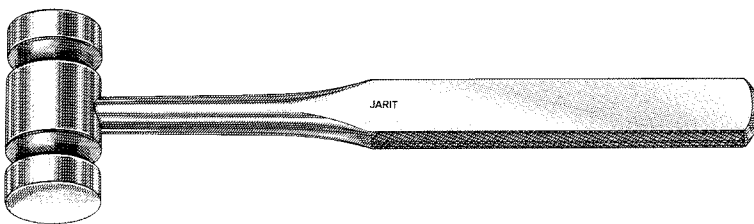

**Lucae Mallet**

Catalog #	Description
250-408	7¾" (200mm), head: weight 5 oz., diameter 1" (25mm)

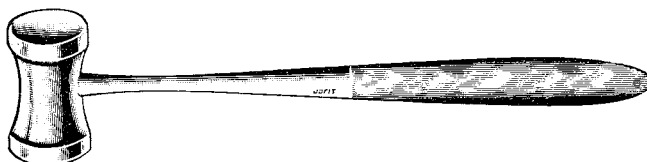

### Cloward Style Ball Pean Hammer

Catalog #	Description
250-411	7½" (192mm), head: weight 8 oz., small face diameter 11/16" (11mm), large face diameter ¾" (20mm)
250-412	9¼" (232mm), head: weight 13 oz., small face diameter 7/8" (22mm), large face diameter 1" (25mm)

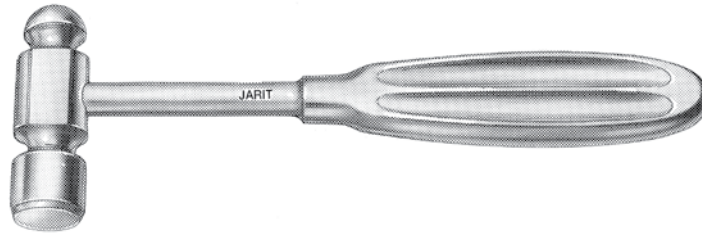

### Mead Mallet

Catalog #	Description
250-415	7½" (190mm), 2 replaceable nylon caps, head: weight 6 oz., diameter 13/16" (20mm)
250-416	Nylon cap for 250-415
250-CLR-415	Replacement Collar

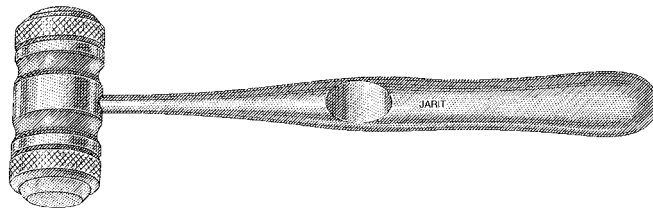

### Kiene Bone Tamp

Catalog #	Description
250-418	6" (152mm), tip 10mm diameter

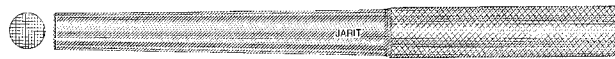

### Bone Tamp

with serrated tips

Catalog #	Description
250-430	6¼" (160mm), tip 2mm diameter
250-431	6¼" (160mm), tip 3mm diameter
250-432	6¼" (160mm), tip 4mm diameter
250-433	6¼" (160mm), tip 5mm diameter
250-434	6¼" (160mm), tip 6mm diameter
250-435	6¼" (160mm), tip 8mm diameter
250-436	6¼" (160mm), tip 10mm d

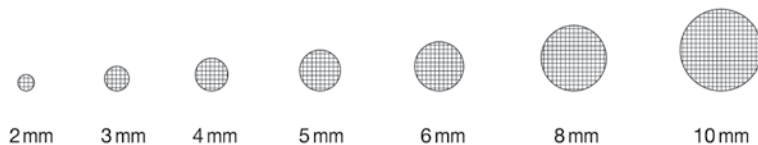

### Key Elevators

solid hexagonal handle

Catalog #	Description
250-420	6¾" (172mm), ⅛" (3mm) wide
250-421	7" (176mm), ¼" (6mm) wide
250-422	7½" (188mm), ⅜" (9mm) wide
250-423	7½" (188mm), ½" (13mm) wide
250-424	7¾" (200mm), ⅝" (16mm) wide
250-425	7¾" (200mm), ¾" (19mm) wide
250-426	8½" (216mm), 1" (25mm) wide

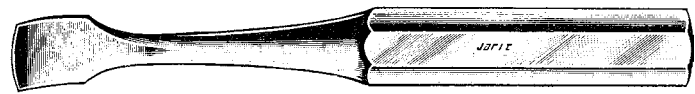

### Crego Elevators

Catalog #	Description
250-470	8" (203mm), 7mm wide, 1⅝" inside radius
250-471	8" (203mm), 7.2mm wide, 1⅞" inside radius
250-472	8" (203mm), 13.5mm wide, 1⅞" inside radius

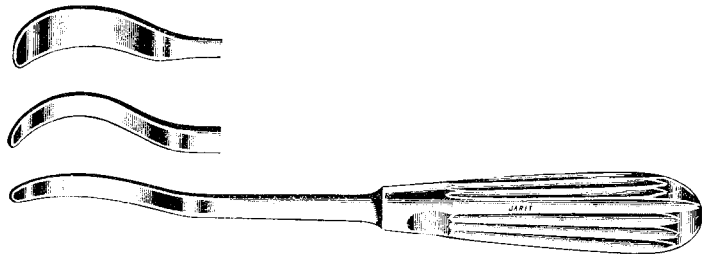

### Chandler Elevators

Catalog #	Description
250-480	7¼" (182mm), maximum blade width 13mm
250-481	8" (203mm), maximum blade width 20mm
250-482	9¼" (232mm), maximum blade width 25mm
250-483	10" (254mm), maximum blade width 31mm



### Langenbeck Elevator

Catalog #	Description
250-490	8¼" (210mm), blade 6.5mm wide

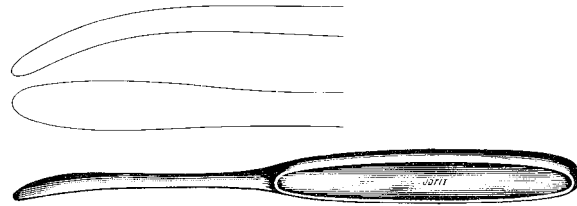

### Langenbeck Elevator

Catalog #	Description
250-492	7¾" (198mm), blade 17.5mm wide

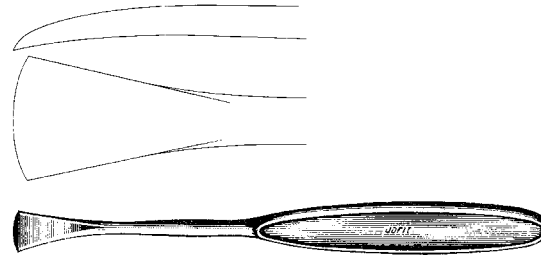

### Lane Elevator

Catalog #	Description
250-495	7¾" (195mm), blade 7mm wide

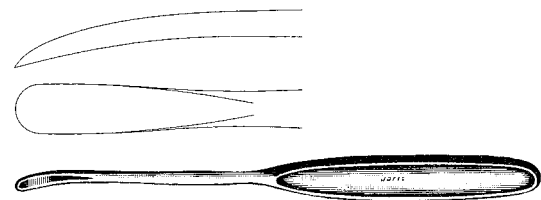

### Lane Elevator

Catalog #	Description
250-496	7¾" (195mm), blade 10mm wide

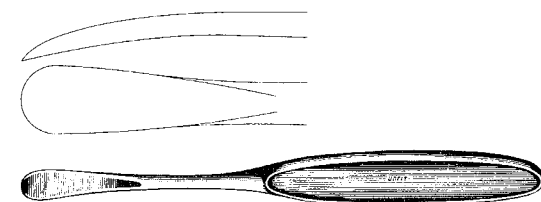

**Sayre Elevator**

Catalog #	Description
250-500	6¾" (171mm), double ended, sharp, blade 9.5mm wide



**Sayre Elevator**

Catalog #	Description
250-502	6¾" (171mm), double ended, blunt, blade 9.5mm wide



**McGlamry Elevators**

Catalog #	Description
250-503	6½" (168mm), sharp, 11mm wide
250-504	6½" (168mm), sharp, 13mm wide
250-505	6½" (168mm), sharp, 15mm wide
250-506	6½" (168mm), sharp, 17mm wide

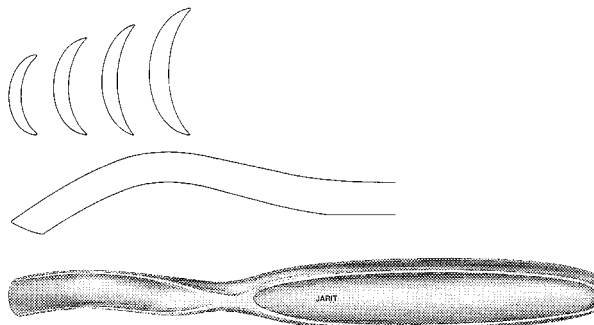

**Seldin Periosteal Elevator #23**

Catalog #	Description
250-509	7¾" (200mm), double ended, blades ½" x 2½" (13mm x 55mm) and ¾" x 2" (10mm x 51mm)



**Sedillot Elevator**

Catalog #	Description
250-510	7½" (190mm), blade 18mm wide



### Mathieu Raspatory

Catalog #	Description
255-100	6¼" (160mm), straight blade 11.7mm wide

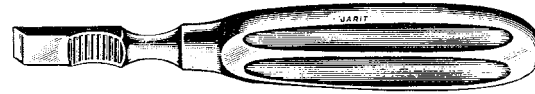

### Farabeuf Raspatory

Catalog #	Description
255-110	5⅞" (150mm), straight blade 12.8mm wide



### Farabeuf Raspatory

Catalog #	Description
255-111	5⅞" (150mm), curved blade 12.8mm wide



### Farabeuf Raspatory

Catalog #	Description
255-112	7½" (190mm), double ended, straight and curved blades 13mm wide



### Gigli Wire Saw Blades

Stille-type, package of 10

Catalog #	Description
260-104	12" (305mm)
260-105	16" (406mm)
260-106	20" (505mm)

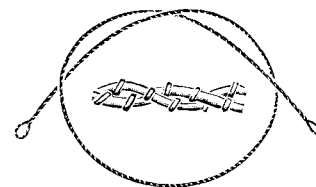

### Gigli Saw Handles

Catalog #	Description
260-109	loop style, pair

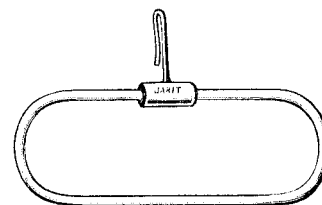

### Gigli Saw Handles

Catalog #	Description
260-110	solid, pair

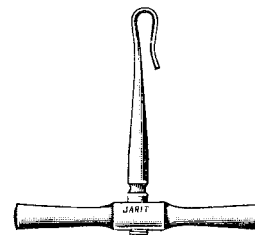

### Bailey Gigli Saw Guide

Catalog #	Description
260-112	13" (330mm)

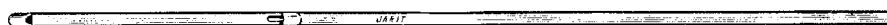

### Satterlee Saw

Catalog #	Description
260-120	11½" (290mm)
260-121	Replacement blade 8½" (213mm)

260-HDL-120 Replacement Handle only

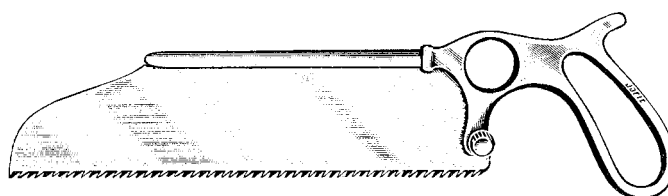



### Langenbeck Metacarpal Saw

Catalog #	Description
260-135	9¼" (235mm), blade 5⅛" (130mm)



### Sweet Amputation Retractor

Catalog #	Description
260-160	11¾" (296mm) wide, neck 4½" (115mm) deep, 1⅝" (41.5mm) tapered

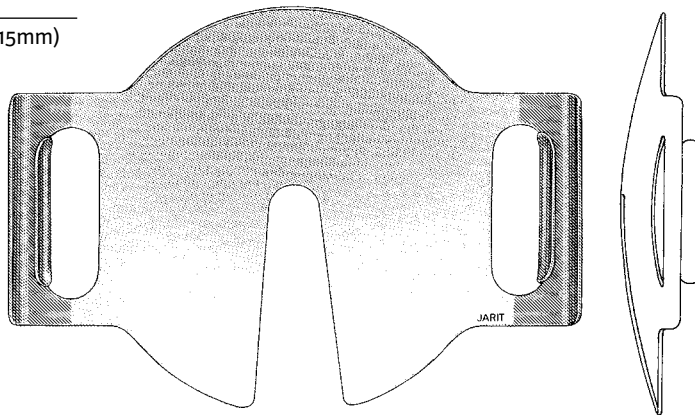

### Putti Rasps

double ended

Catalog #	Description
260-200	11¾" (300mm), one round blade and one half round blade
260-201	10¾" (270mm), flat blades, one blade curved up and one blade curved sideways

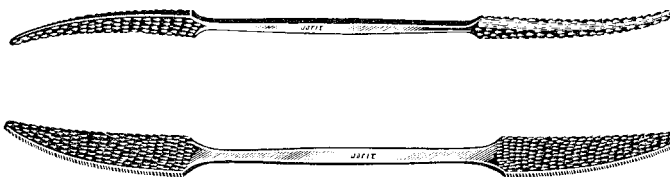

### Miller Rasp

Catalog #	Description
260-205	7" (180mm), double ended, 5.3mm x 6.3mm wide serrated tips

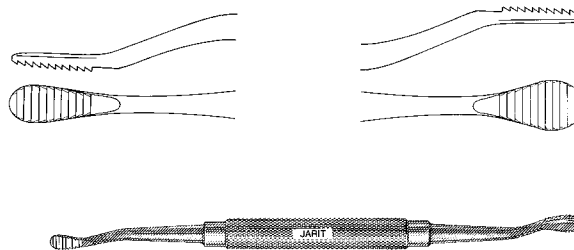

### Bone File

Catalog #	Description
260-210	9¾" (245mm), half round blade, ⅝" wide x ¾" length (15mm x 95mm)



### Smillie Meniscus Knives

Catalog #	Description
270-120	6¾" (171mm), straight edge
270-121	6¾" (171mm), left
270-122	6¾" (171mm), right

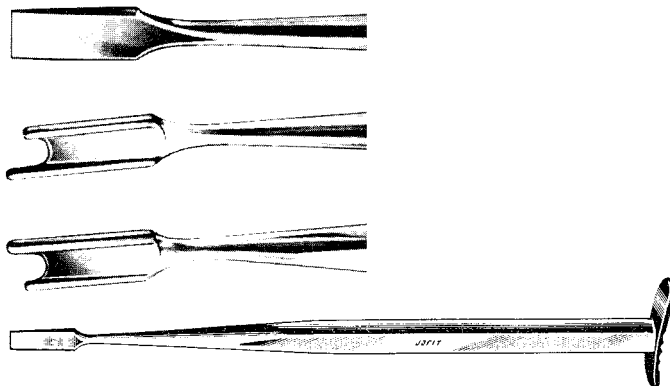

### Martin Cartilage Scissors

Catalog #	Description
270-150	7¾" (200mm), curved, 50mm serrated blade

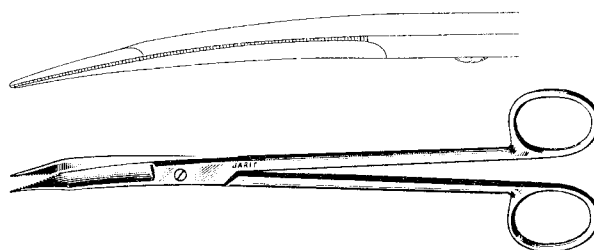

### Martin Cartilage Clamp

Catalog #	Description
270-157	7¼" (187mm), straight, ⅛" wide x ⅞" length (3.5mm x 22mm) jaws

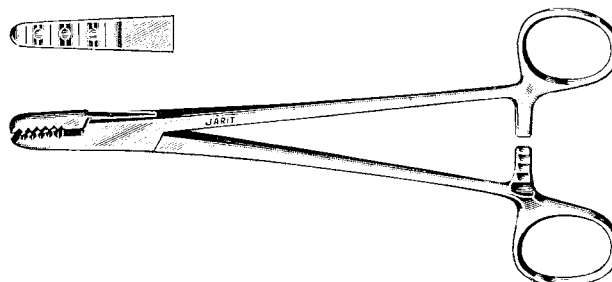

### Walton Meniscus Clamp

Catalog #	Description
270-165	7" (180mm), straight, 1/4" wide x 7/8" length (5.7mm x 22mm) jaws

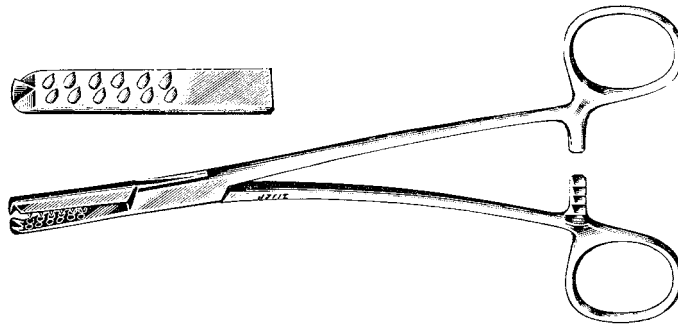

### Walton Cartilage Clamp

angled on the flat

Catalog #	Description
270-170	8" (205mm), angled jaws, 1/4" wide x 3/4" length (6.6mm x 20mm) jaws

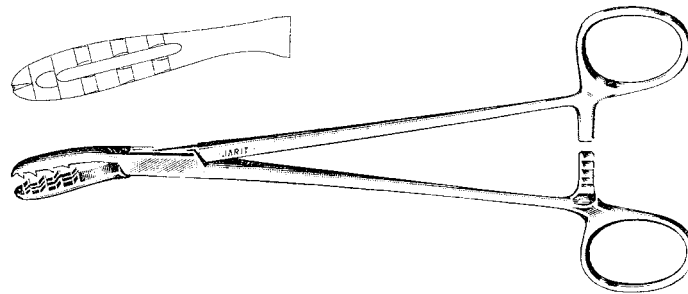

### Dingman Cartilage Clamps

angled on the side

Catalog #	Description
270-175	7 1/4" (186mm), straight jaws, delicate, 3/16" wide x 1/2" length (4mm x 37mm) jaws
270-176	7 1/4" (186mm), straight jaws, heavy, 3/16" wide x 1/2" length (5mm x 37mm) jaws

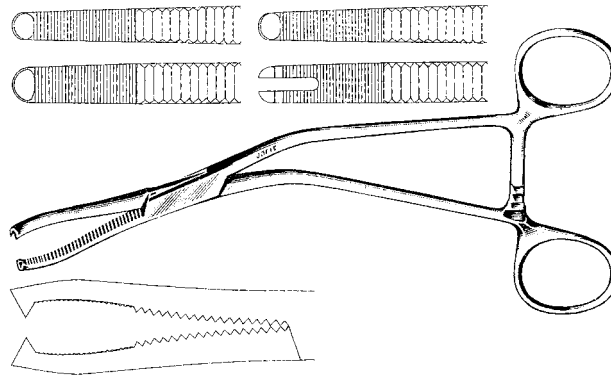

### Preston Ligamentum Flavum Forceps

Catalog #	Description
270-180	7 1/4" (185mm)

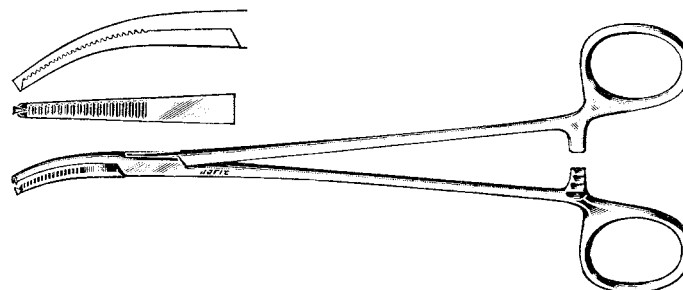

**Locke Phalangeal Forceps**

Catalog #	Description
270-182	6¼" (156mm), 22mm serrated jaws, 1 x 2 teeth

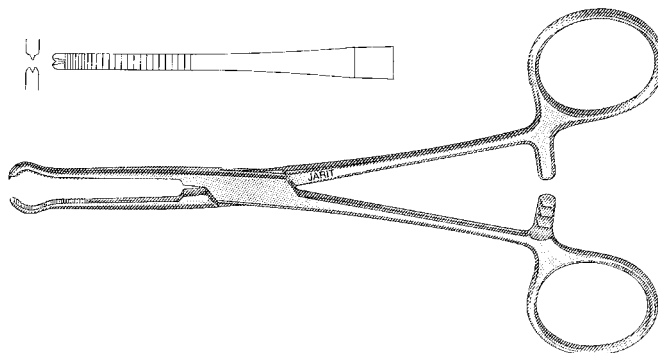

**Sesamoidectomy Clamp**

Catalog #	Description
270-183	6½" (167mm), curved

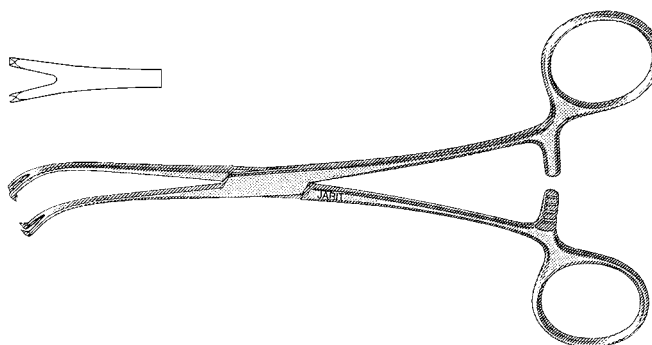

**Carroll Tendon Retriever**

Catalog #	Description
270-185	5½" (140mm), curved shaft, 2mm x 8mm serrated jaws, alligator action

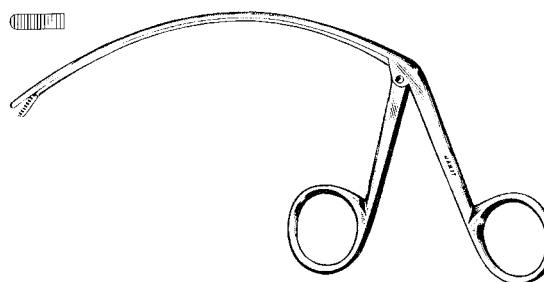

**Carroll Small Bone Holding Clamp**

Catalog #	Description
270-186	6½" (164mm), serrated jaws

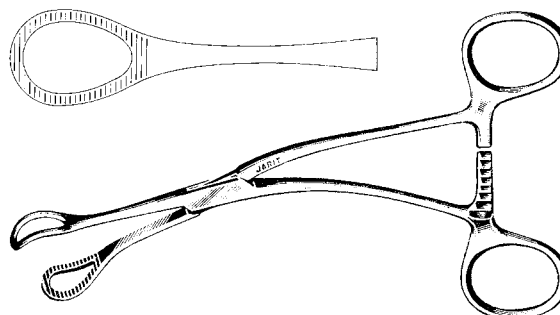

### Brand Tendon Pulling Forceps

2 x 3 teeth

Catalog #	Description
270-187	6" (155mm), 1/8" wide x 5/8" length (3.4mm x 15mm) jaws
270-188	7 1/2" (190mm), 1/8" wide x 7/8" length (3.5mm x 22mm) jaws
270-189	9 3/4" (245mm), 1/8" wide x 7/8" length (3.5mm x 22mm) jaws

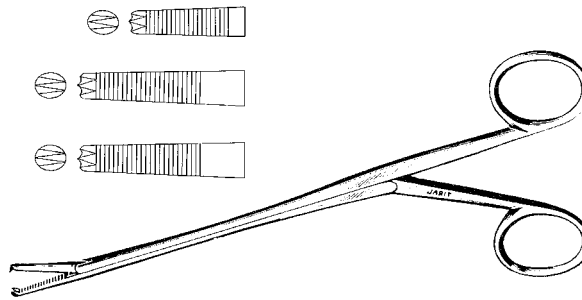

### Tendon Braiding Forceps

Catalog #	Description
270-195	6" (152mm), 8mm pointed tip, straight
270-196	6" (152mm), 8mm pointed tip, curved

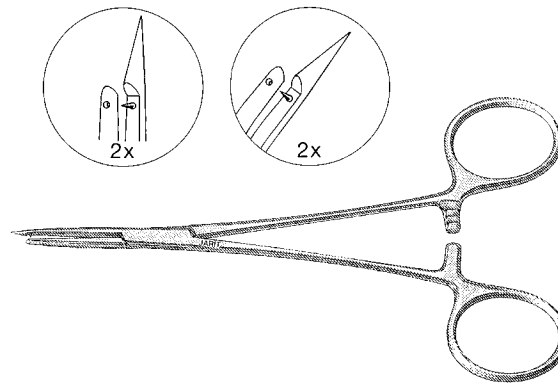

### Bunnell Tendon Passers and Forwarding Probes

Catalog #	Description
270-197	7 1/4" (185mm)
270-198	9" (230mm)



### Kleinert-Kutz Tendon Retriever

Catalog #	Description
270-200	8 1/2" (215mm), 1.5mm wide x 8mm length, serrated, 1 x 2 teeth

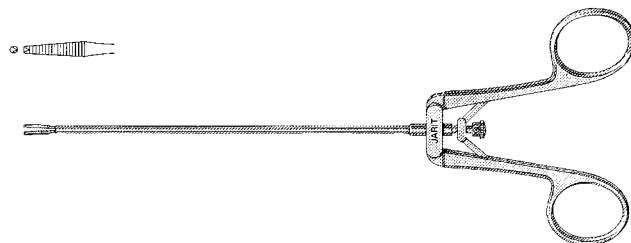

### Finger Goniometer

Catalog #	Description
270-225	5 1/2" (140mm)

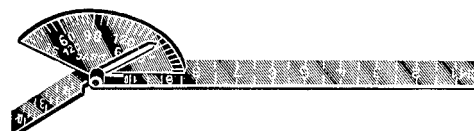

### Nail Splitters

with solid octagon handles

Catalog #	Description
840-100	5" (127mm), straight 2mm
840-110	5" (127mm), angled 2mm
840-120	5" (127mm), straight 3.5mm
840-130	5" (127mm), angled 3.5mm

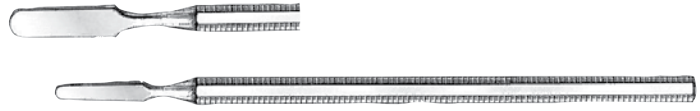

### Hand Gouge

with solid octagon handles

Catalog #	Description
840-140	5" (127mm), round tip, 2.5mm

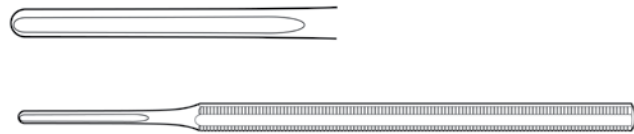

### Curette Excavators

with solid octagon handles, single end without holes

Catalog #	Description
840-200	5" (127mm), 1mm
840-205	5" (127mm), 1.5mm
840-210	5" (127mm), 2mm
840-215	5" (127mm), 2.5mm



### Curette Excavators

with solid octagon handles, double ended with holes

Catalog #	Description
840-220	5 1/2" (140mm), 1.5mm x 2mm



### Williger Bone Curette

double ended

Catalog #	Description
840-225	5 1/2" (140mm), 3mm and 4mm wide oval cups



### Martini Bone Curette

double ended

Catalog #	Description
840-230	5½" (140mm), 4mm and 5mm dia round cups



### Locke Elevator

with solid octagon handles

Catalog #	Description
840-300	Small blade, 5" (127mm), 3mm wide x 15mm length
840-305	Large blade, 5½" (140mm), 5mm wide x 20mm length



### Nail or Bone Rasp

with solid octagon handle

Catalog #	Description
840-310	6¾" (172mm), double ended, 1 end inside and 1 end outside for better conformity



### Ingrown Nail Cutter

with solid octagon handle

Catalog #	Description
840-315	5" (127mm), sharp hook edge



**Probe and Packer**

with solid octagon handle

Catalog #	Description
840-320	6" (152mm), double ended, blunt probe and 2mm x 25mm packer



**Platypus Nail Pulling Forceps**

stainless

Catalog #	Description
840-325	5 1/2" (140mm), standard wide jaws
840-330	5 1/2" (140mm), narrow jaws

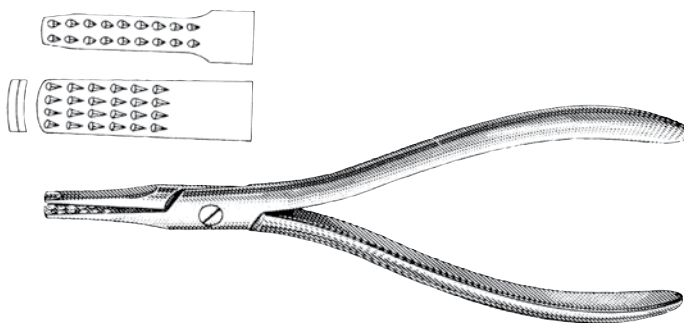

**Ingrown Nail Splitting Scissors**

stainless

Catalog #	Description
840-335	6" (152mm), one blade serrated

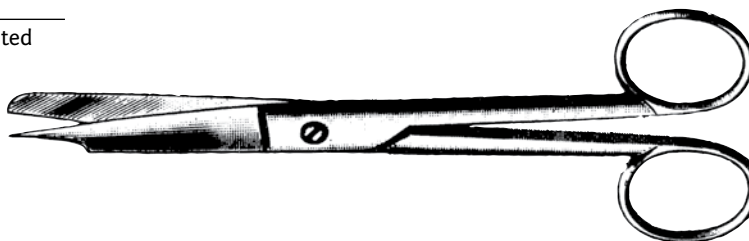

**Tissue and Cuticle Nipper**

stainless

Catalog #	Description
840-340	4" (102mm), 5mm long convex blades

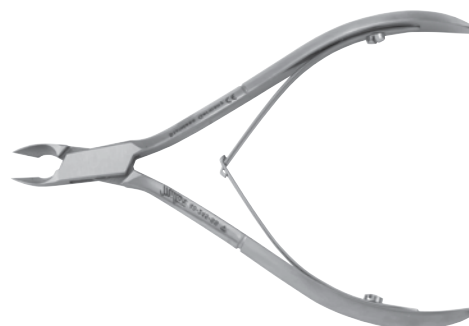



### Tissue Nipper

stainless

Catalog #	Description
840-345	4½" (115mm), 10mm convex blades
840-350	5" (140mm), 8mm convex blades



### Collar and Crown Style Wire Scissors

smooth blades

Catalog #	Description
840-355	4¼" (108mm), straight
840-360	4¾" (115mm), straight
840-365	4¼" (108mm), curved
840-370	4¾" (115mm), curved

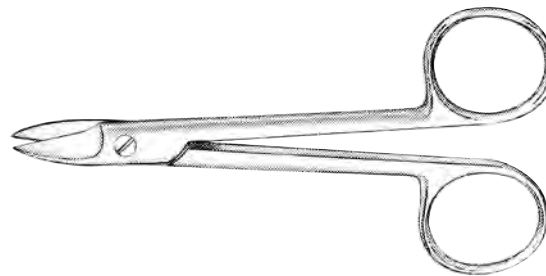

### Schink Metatarsal Spreader

Catalog #	Description
841-110	4½" (115mm)



### Polokoff Bone Files

Catalog #	Description
842-100	7¼" (184mm), double ended, narrow pattern
842-105	6" (152mm), short head, fine serrations
842-110	6½" (165mm), 1.3mm wide, straight

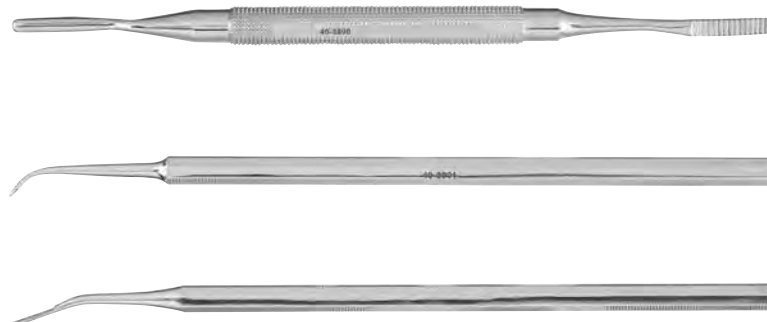

### Nail Nippers

stainless

Catalog #	Description
842-500	5½" (140mm), angled concave jaws, double spring
842-505	5½" (140mm), straight jaws, double spring



### Hand Chisel

with solid octagon handle

Catalog #	Description
842-600	5" (127mm), curved edge, 6mm wide



### Nucleus Knife

with solid octagon handles

Catalog #	Description
842-605	5" (127mm), 2mm wide
842-610	5" (127mm), 3mm wide
842-615	5" (127mm), 4mm wide



### Packer and Excavator

with solid octagon handle

Catalog #	Description
842-620	5½" (140mm), blunt hook end and 2mm x 25mm packer



### Universal Hand Drill

Catalog #	Description
275-125	9 <sup>3</sup> / <sub>4</sub> " (247mm) cannulated, 3-jaw stainless Jacobs chuck, accepts wire/pin up to 4mm (3/16"), aluminum body with offset handle

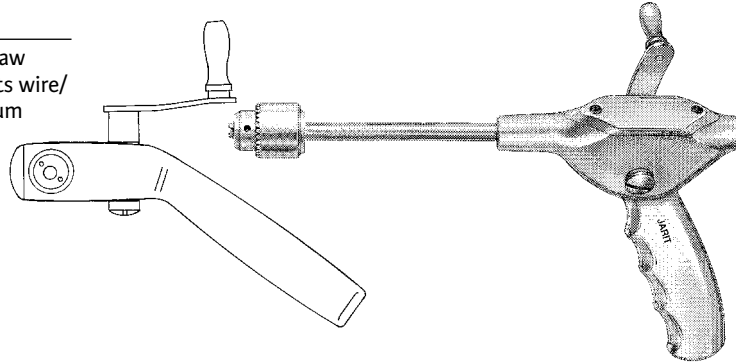

### Universal Hand Drill

Catalog #	Description
275-126	6 <sup>1</sup> / <sub>4</sub> " (160mm) cannulated, 3-jaw stainless Jacobs chuck, accepts wire/pin up to 4mm (3/16"), aluminum body with offset handle

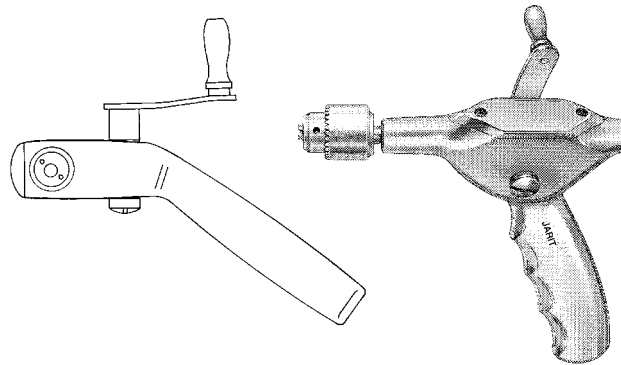

### Bunnell Hand Drill with Jacobs Hand Chuck

Catalog #	Description
275-135	5 <sup>1</sup> / <sub>2</sub> " (141mm), accepts wire/pin up to 4mm (3/16")
275-KEY-135	Replacement Jacobs Chuck Key Only

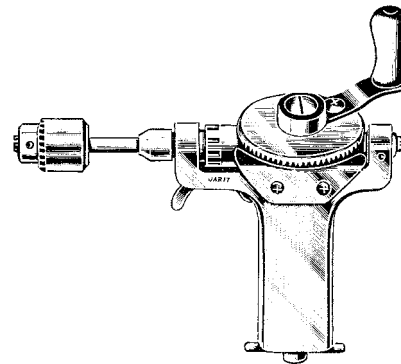

### Wire Pulling Forceps

Catalog #	Description
275-140	6½" (166mm), maximum capacity 1mm, 21.5mm jaw with 17mm platform

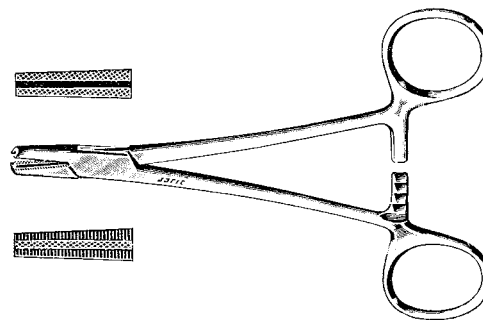

### Corwin Wire Twister, Carb-Bite

Catalog #	Description
275-145	11" (280mm), overall length, 5⅞" (150mm) working length, 3.2mm wide tip x 11mm long jaws

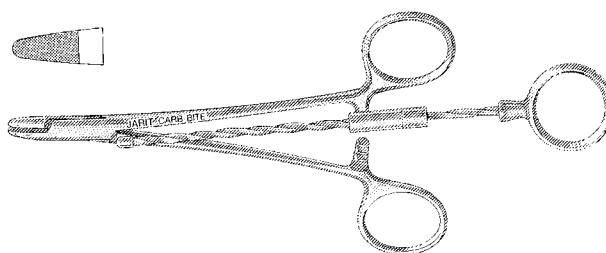

### Sternal Needle Holder and Wire Twister, Carb-Bite

4000 teeth per square inch, for use with 1.0 and 2.0 suture

Catalog #	Description
121-250	5¼" (132mm) (Rubio)
121-255	7" (176mm)
121-260	7¼" (186mm), heavy duty 5mm wide jaws (Berry)

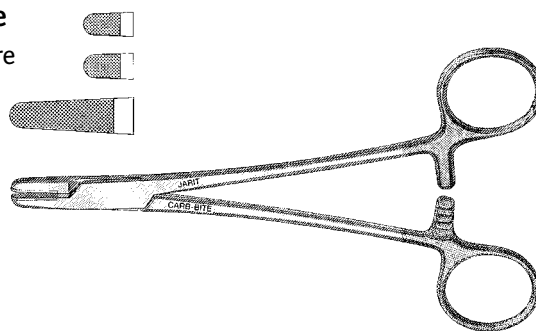

### Cooley-Baumgarten, Sternal Wire Twister, Carb-Bite

2500 teeth per square inch, for use with 1.0 and 2.0 suture

Catalog #	Description
121-265	8" (205mm), heavy duty, blunt jaws, textured tips

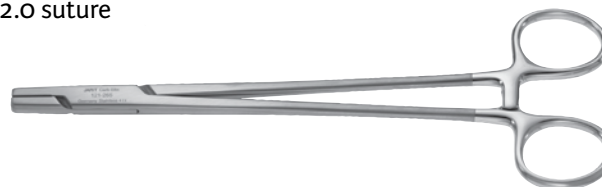

### Wire Twisters, Carb-Bite

2500 teeth per square inch, for use with 1.0 and 2.0 suture

Catalog #	Description
121-257	6" (155mm), short delicate jaws
121-258	6" (155mm), short blunt jaws

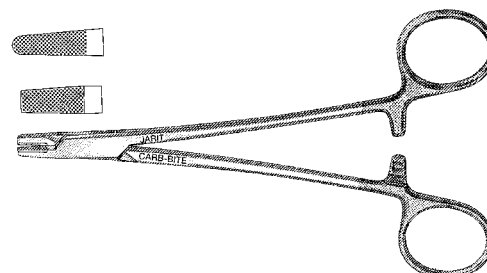

### Hercules Supercutter, Large

tungsten-carbide blades are replaceable

Catalog #	Description
275-500	8½" (219mm) length, maximum capacity 0.118" (3mm)
275-501	Replacement blade kit for 275-500 includes: 1 pair tungsten carbide blades 4 screws 1 hexagonal key
275-502	Protective Shield for 275-500, set of 2

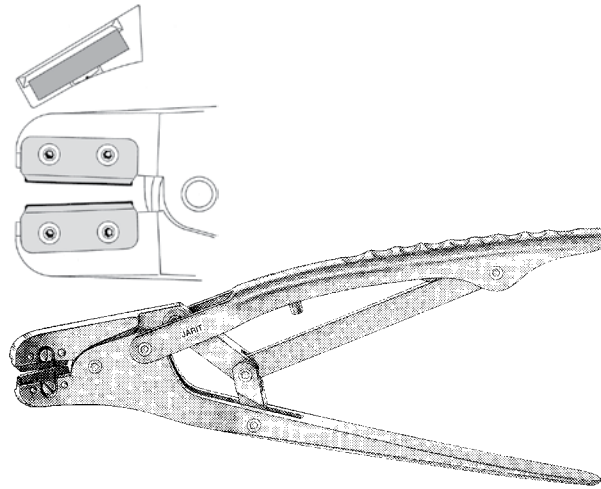

### Hercules Supercutter, Small

Catalog #	Description
275-503	7" (175mm) length, maximum capacity 0.087" (2.2mm)
275-504	Replacement blade kit for 275-503 includes: 1 pair tungsten carbide blades 4 screws 1 hexagonal key
275-505	Protective Shield for 275-503, set of 2

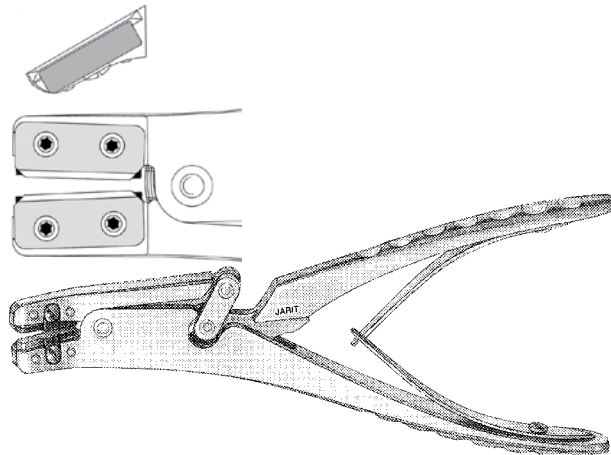

### Diamond Pin Cutter

Catalog #	Description
275-155	6½" (162mm), maximum capacity 0.079" (2mm)

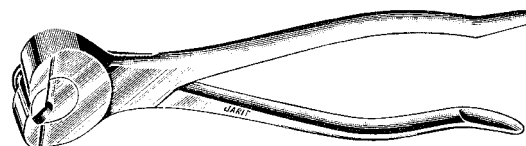

**Double Action Wire Cutters, Carb-Edge**  
up-angled jaws

Catalog #	Description
275-510	7¼" (181mm), maximum capacity 0.067" (1.7mm)
275-515	8¾" (222mm), maximum capacity 0.098" (2.5mm)

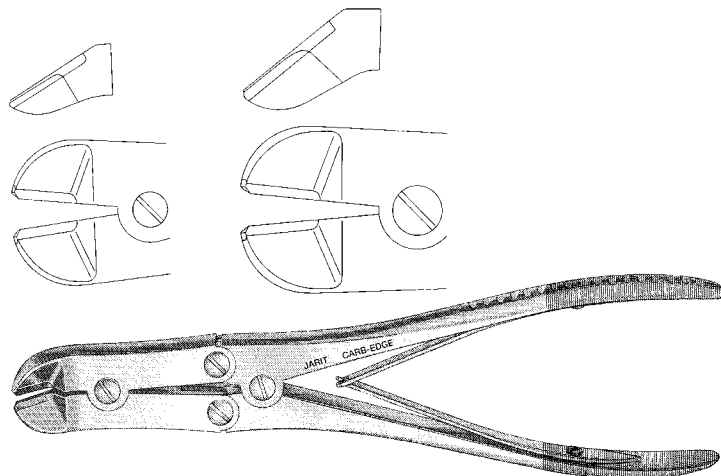

**Flush Wire Cutter, Carb-Edge**  
straight

Catalog #	Description
275-525	6¾" (170mm), maximum capacity 0.067" (1.7mm)

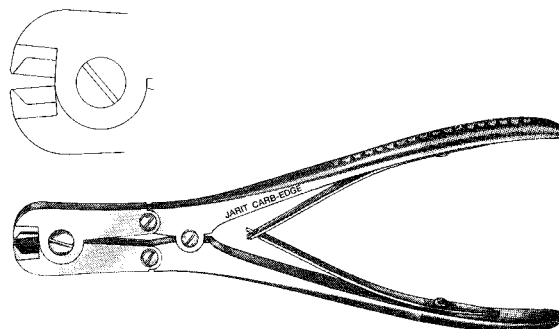

**Wire Cutter, Side Cutting, Carb-Edge**

Catalog #	Description
275-530	7¼" (186mm), maximum capacity 0.059" (1.5mm)

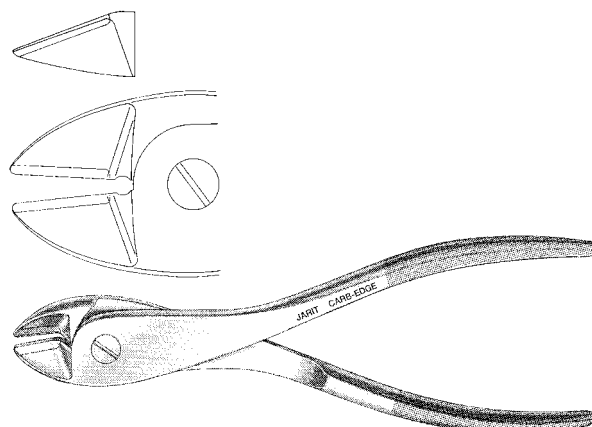

### Cannulated Pin Cutter

Catalog #	Description
275-540	7 <sup>1</sup> / <sub>4</sub> " (184mm), end-cutting, maximum capacity .063" (1.6mm)

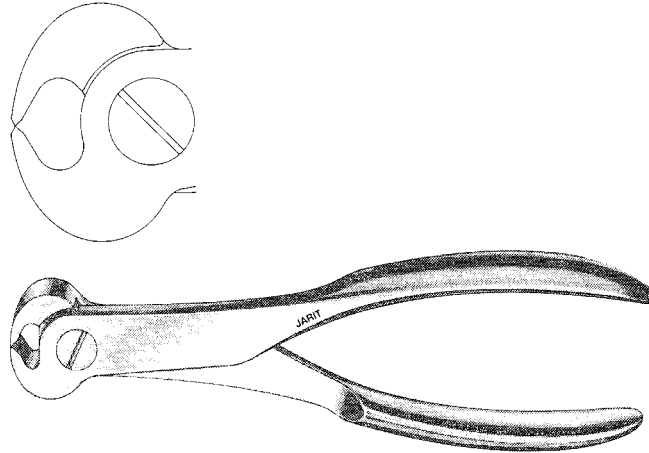

### Large Pin Cutter

Catalog #	Description
275-550	22 <sup>1</sup> / <sub>2</sub> " (571mm), cuts rods up to .250" (6.3mm) with toggle joint

- 275-JWA-550 Replacement Jaw Assembly
- 275-JWA-550I Replacement Jaw Assembly Installed

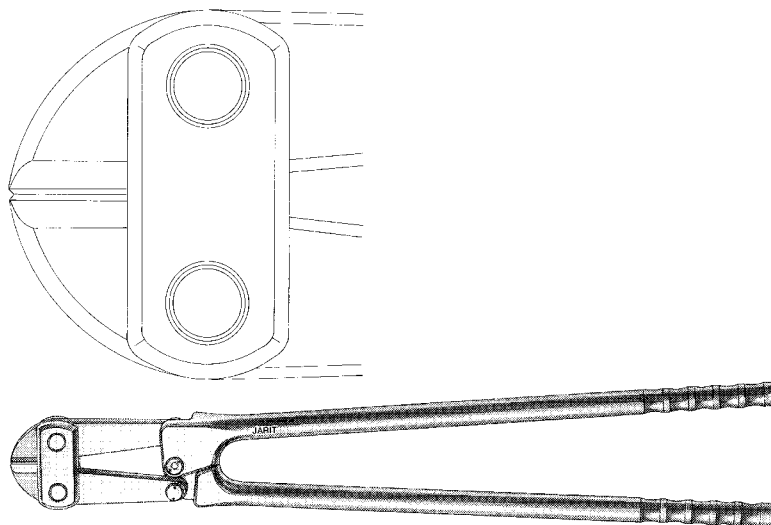

### Slip Joint Utility Pliers

Catalog #	Description
275-555	7 <sup>3</sup> / <sub>4</sub> " (198mm)

275-NTB-555	Replacement Nut and Bolt Set
-------------	------------------------------

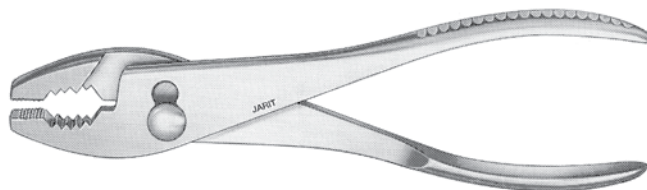
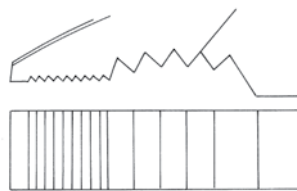

### Parallel Pliers

Catalog #	Description
275-560	7 <sup>1</sup> / <sub>4</sub> " (184mm), grooved 10mm wide jaws for pin removal

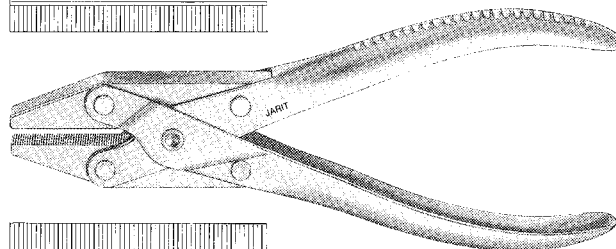
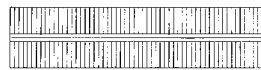

### Parallel Pliers with side cutter

Catalog #	Description
275-561	7 <sup>1</sup> / <sub>4</sub> " (184mm), grooved 10mm wide jaws for pin removal, maximum capacity .063" (1.6mm)

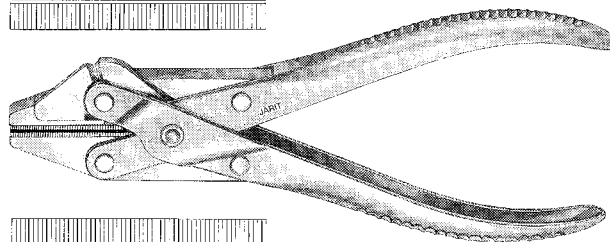

### Needle Nose Pliers

Catalog #	Description
275-565	5 <sup>1</sup> / <sub>4</sub> " (133mm), grooved jaws, tips taper to 1mm

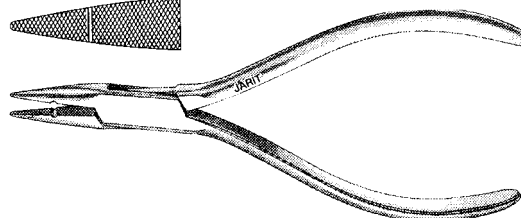



**Flat Nose Pliers**

Catalog #	Description
275-570	5 <sup>7</sup> / <sub>8</sub> " (150mm), tips taper to 2mm

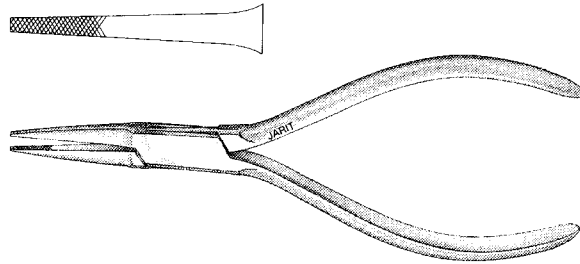

**Flat Nose Pliers**

with side cutter

Catalog #	Description
275-580	6 <sup>1</sup> / <sub>2</sub> " (162mm) side cutting blades, tips taper to 3.5mm

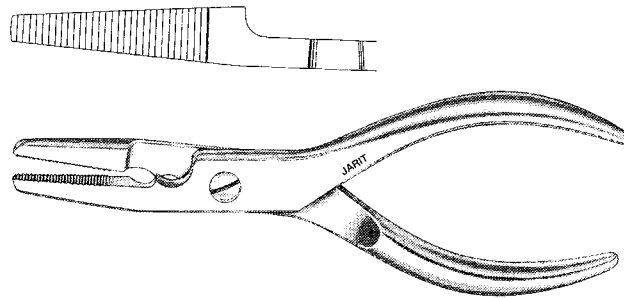

**Heavy Duty Locking Pliers**

reinforced jaw hinge, self-locking lever with adjustment screw and one-handed quick release

Catalog #	Description
275-589	7" (180mm), 8mm wide tip
275-590	8" (205mm), 9mm wide tip
275-591	10" (255mm), 13mm wide tip

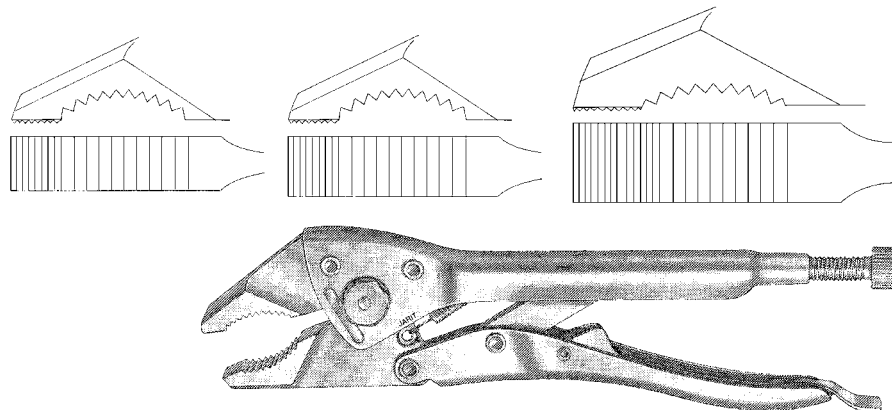

### Heavy Duty Needle Nose Locking Pliers

reinforced jaw hinge, self-locking lever with adjustment screw and one-handed quick release

Catalog #	Description
275-594	8¾" (220mm), 5mm wide tip
275-595	9½" (241mm), 5mm wide tip
275-596	11½" (292mm), 7mm wide tip

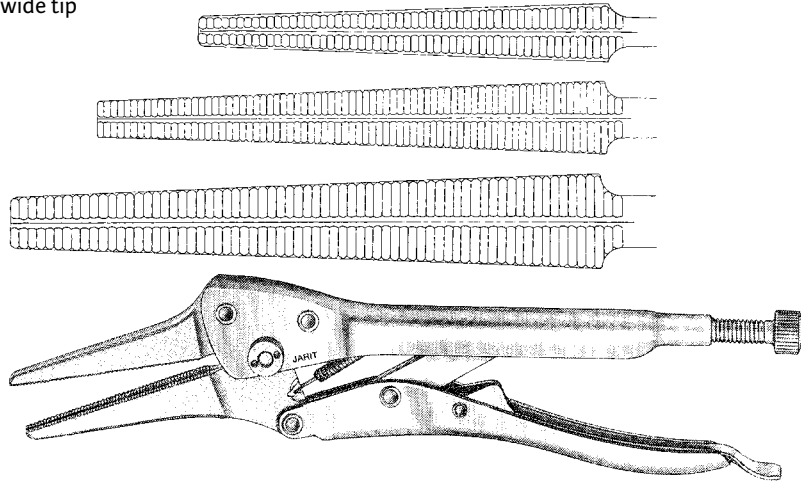

### Townley Femur Caliper

Catalog #	Description
275-600	4½" (115mm)
275-SSC-600	Replacement Set Screw pkg/2ea

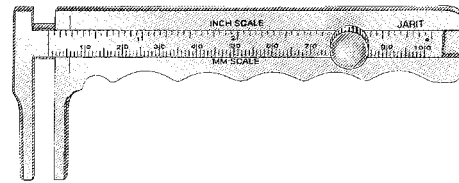

**Integra**<sup>™</sup>  
Microsurgical  
Instruments and  
General Surgical  
Instruments

### Broli-Adson Forceps

1.2mm tips

Catalog #	Description
130-246	6" (152mm), straight, serrated tips
130-247	6" (152mm), curved, serrated tips
130-248	6" (152mm), straight, Stardust tips
130-249	6" (152mm), straight, 1 x 2 teeth



### Microsurgical Forceps with Platform

7" (180mm) round handle

Catalog #	Description
277-040	Straight, 0.4mm micro tip
277-041	Straight, 0.5mm micro tip, 1 x 2 teeth
277-042	Straight, 0.8mm delicate tip
277-043	Straight, 0.8mm delicate tip, 1 x 2 teeth
277-044	Curved, 0.4 micro tip
277-045	Curved, 0.5mm micro tip, 1 x 2 teeth
277-046	Curved, 0.8mm delicate tip
277-047	Curved, 0.8mm delicate tip, 1 x 2 teeth

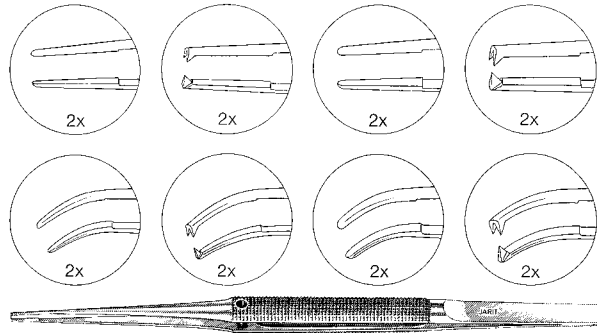

### Rhoton-Type Suture Tying Forceps

with 6mm platform, round handle

Catalog #	Description
277-049	7" (178mm), straight

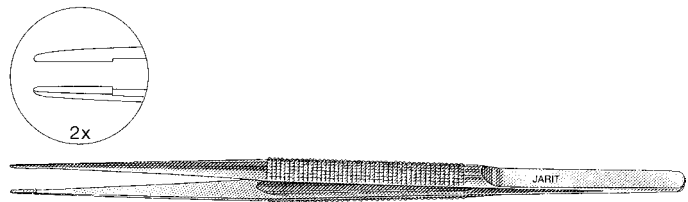

### Micro Suture Tying Forceps

with 6mm platform, round handle

Catalog #	Description
277-080	6" (152mm), straight
277-081	6" (152mm), curved

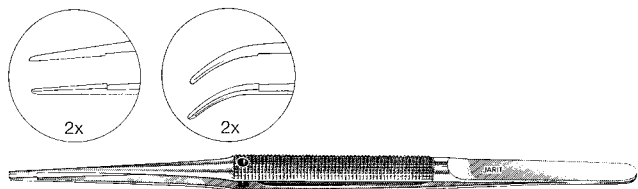

**Microsurgical Scissors, Wide Handle**

5½" (140mm), 12mm regular blades

Catalog #	Description
277-050	Straight
277-051	Curved
277-053	Straight, serrated
277-054	Curved, serrated

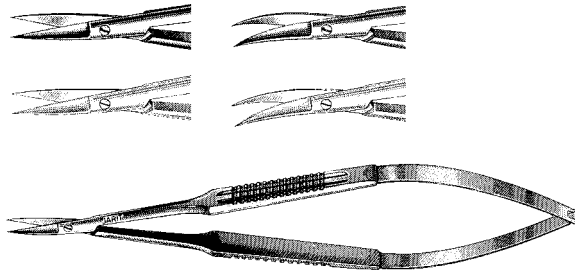

**Microsurgical Scissors, Wide Handle**

5½" (140mm), 12mm micro blades

Catalog #	Description
277-056	Straight
277-057	Curved

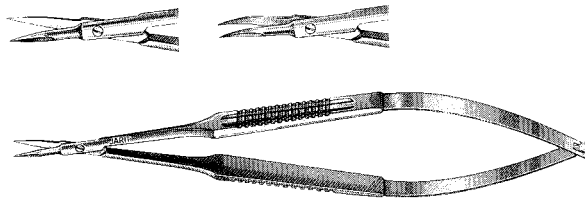

**Dennis Micro Scissors, Round Handle, Double-Action**

7¼" (184mm), 8mm micro blades

Catalog #	Description
277-058	Straight blades
277-059	Curved blades



**Microsurgical Scissors, Round Handle**

7" (178mm), 13mm regular blades

Catalog #	Description
277-060	Straight
277-061	Curved
277-062	Angled to side, 60°

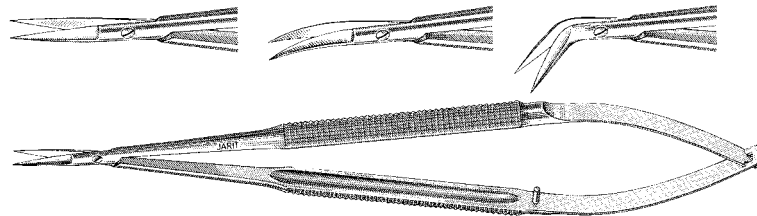

**Microsurgical Scissors, Round Bayonet Handle**

8½" (215mm), 14mm regular blades

Catalog #	Description
277-065	Straight
277-066	Curved

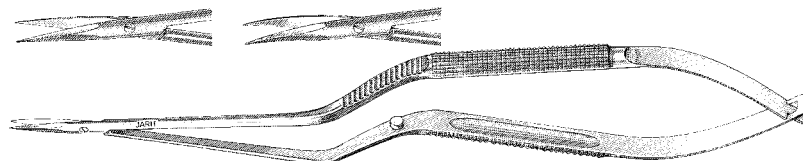

**Microsurgical Needle Holders, Round Handle**

5½" (140mm), 0.6mm x 10mm length jaws

Catalog #	Description
277-070	Straight jaw
277-071	Curved jaw
277-072	Straight jaw, catch
277-073	Curved jaw, catch

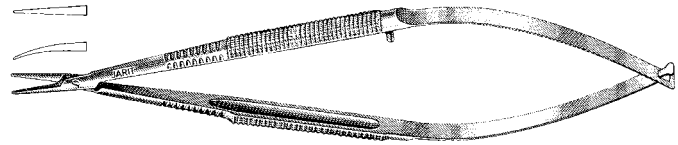

**Microsurgical Needle Holders, Wide Handle**

5¾" (146mm), 0.7mm x 12mm length jaws

Catalog #	Description
277-075	Straight jaw
277-076	Curved jaw

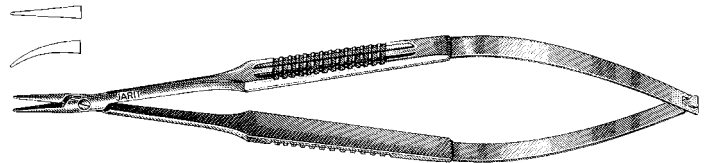

**Microsurgical Needle Holders, Round Handle**

7" (180mm)

Catalog #	Description
277-090	Straight jaw (0.6mm wide x 10mm long), micro tip
277-091	Straight jaw (0.6mm wide x 10mm long), micro tip, catch
277-092	Straight jaw (0.8mm wide x 9mm long), delicate tip
277-093	Straight jaw (0.8mm wide x 9mm long), delicate tip, catch
277-094	Curved jaw (0.6mm wide x 10mm long), micro tip
277-095	Curved jaw (0.6mm wide x 10mm long), micro tip, catch
277-096	Curved jaw (0.8mm wide x 10mm long), delicate tip
277-097	Curved jaw (0.8mm wide x 10mm long), delicate tip, catch

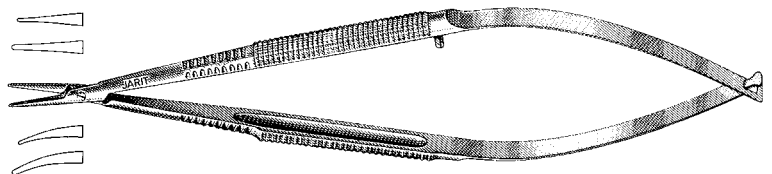

### Yasargil Scissors, Flat Bayonet Handle

9" (227mm)

Catalog #	Description
277-100	Straight, 14mm regular blade
277-101	Curved, 14mm regular blade
277-103	Straight, 12mm micro blade
277-104	Curved, 12mm micro blade

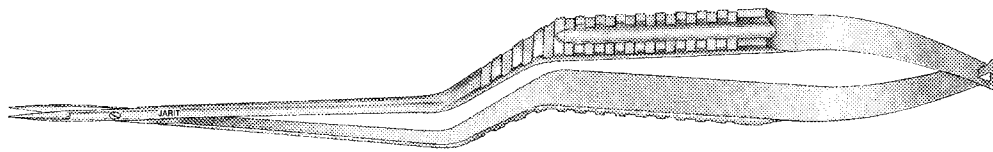

### Yasargil Needle Holders, Flat Bayonet Handle

8¾" (225mm)

Catalog #	Description
277-110	Straight jaw
277-111	Curved jaw

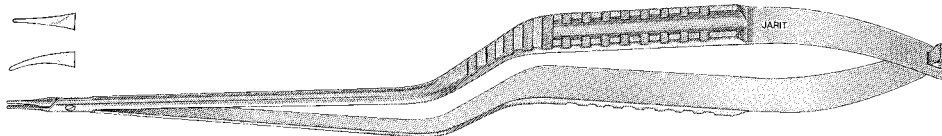

### Yasargil Forceps, Flat Bayonet Handle

9" (229mm)

Catalog #	Description
277-115	Blunt tips, 0.8mm
277-116	Sharp tips, 0.3mm

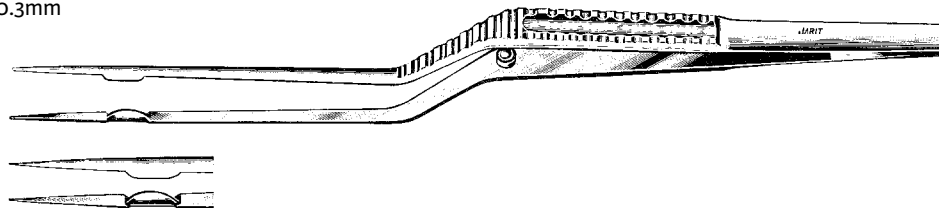

**Jacobson Scissors, Flat Handle**

7" (180mm)

Catalog #	Description
277-120	Straight, 15mm blade
277-121	Curved, 15mm blade
277-122	Angled on the side, 10mm blade

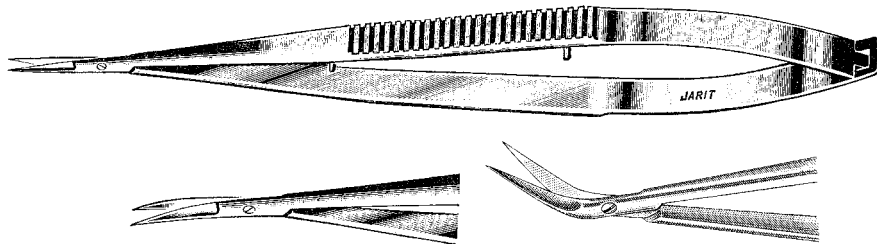

**Jacobson Micro Scissors, Flat Handle**

7" (178mm), 12mm blades

Catalog #	Description
277-123	Straight blades, blunt tips
277-124	Curved blades, blunt tips



**Jacobson Scissors, Flat Bayonet Handle**

7 1/4" (185mm)

Catalog #	Description
277-130	Straight, 13mm regular blade
277-131	Curved, 13mm regular blade
277-132	Angled on the side, 10mm regular blade
277-135	Straight, 11mm micro blade
277-136	Curved, 11mm micro blade

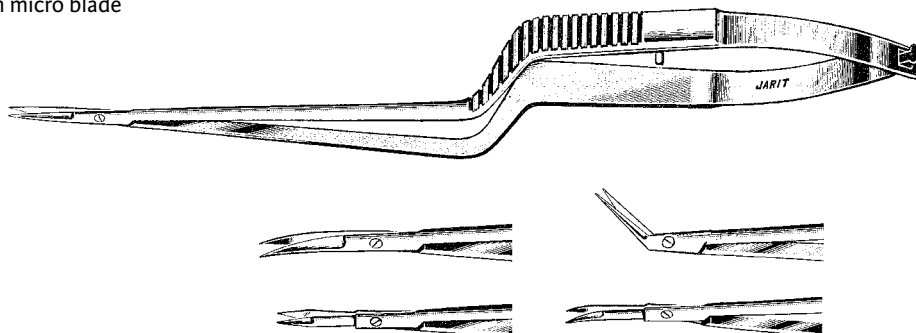



**Jacobson Micro Scissors, Flat Handle**

9mm micro fine blades

Catalog #	Description
277-330	6 1/2" (165mm), 25 degree angle
277-331	6 1/2" (165mm), 45 degree angle
277-332	6 1/2" (165mm), 60 degree angle
277-333	6 1/4" (159mm), 90 degree angle
277-334	6 1/4" (159mm), 120 degree angle



**Jacobson Micro Scissors, Round Handle**

9mm micro fine blades

Catalog #	Description
277-335	6 3/4" (170mm), 25 degree angle
277-336	6 3/4" (170mm), 45 degree angle
277-337	6 3/4" (170mm), 60 degree angle
277-338	6 1/2" (165mm), 90 degree angle
277-339	6 1/2" (165mm), 120 degree angle

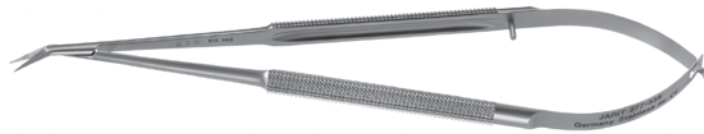

**Jacobson Needle Holder, Flat Handle, Straight**

7" (178mm), 1.4mm x 12mm length jaws

Catalog #	Description
277-140	Without catch
277-141	With catch

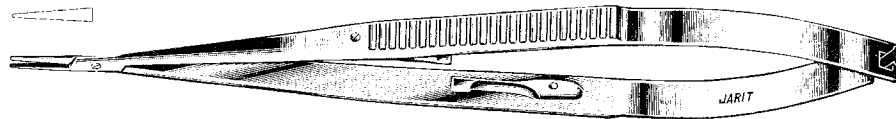

**Jacobson Needle Holder, Flat Bayonet Handle, Without Catch**

7" (180mm)

Catalog #	Description
277-145	Straight jaw, jaws 0.8mm wide x 12mm long
277-147	Fine curved jaw, jaws 0.8mm wide x 9mm long

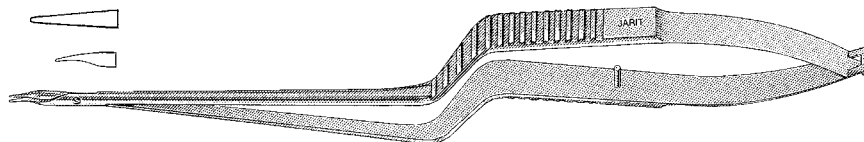

**Castroviejo Style Microsurgical Needle Holders, Carb-Bite**

7000 teeth per square inch, 1mm tips, for use with 5.0, 6.0 and 7.0 suture serrated jaws

Catalog #	Description
121-229	7" (178mm)
121-229NL	7" (178mm) (Non Locking)
121-231	8½" (216mm)
121-231NL	8½" (216mm) (Non Locking)

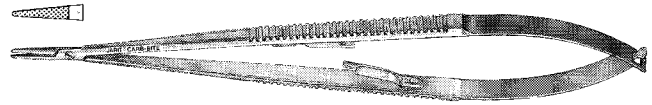

**Castroviejo Style Microsurgical Needle Holders, Carb-Bite**

1mm tips, for use with 5.0, 6.0 and 7.0 suture smooth jaws

Catalog #	Description
121-228	7" (178mm)
121-228NL	7" (178mm) (Non Locking)
121-230	8½" (216mm)
121-230NL	8½" (216mm) (Non Locking)

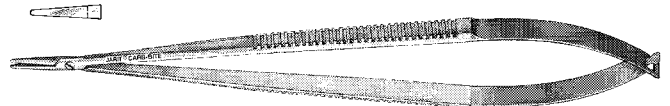

**Jacobson Forceps, Flat Bayonet Handle**

6¼" (160mm)

Catalog #	Description
277-159	sharp tips

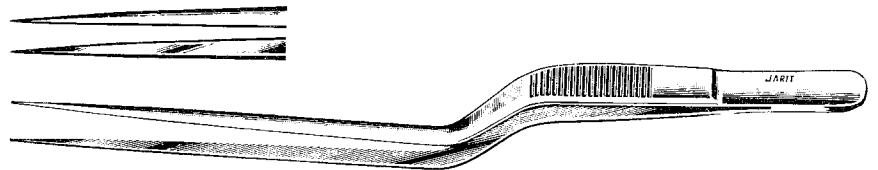

**Jacobson Forceps, Flat Bayonet Handle**

7¼" (185mm)

Catalog #	Description
277-160	0.8mm blunt tips
277-161	0.3mm sharp tips
277-162	0.8mm angled blunt tips

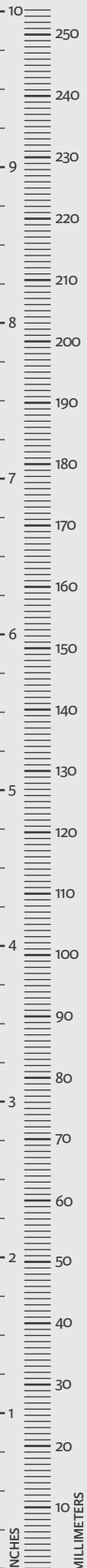
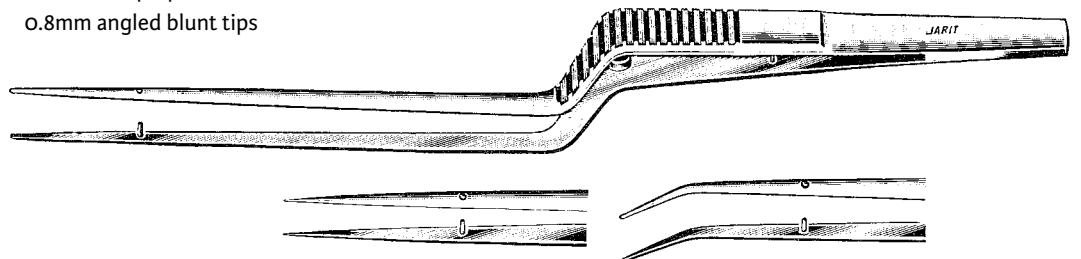



**Jacobson Instruments, Straight Round Handle**

7 1/4" (185mm)

Catalog #	Description	
277-200	Vessel knife	
277-202	Blood vessel probe	
277-204	Blood vessel probe and supporter	
277-206	Suture pusher	

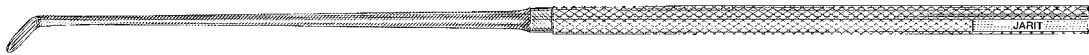

**Yasargil Instruments, Straight Round Handle**

7 1/4" (185mm)

Catalog #	Description	
277-210	Raspatorium, wide blade	
277-211	Raspatorium, narrow, light curve	
277-212	Raspatorium, narrow, strong curve	
277-213	Raspatorium, angled	
277-215	Dissector	

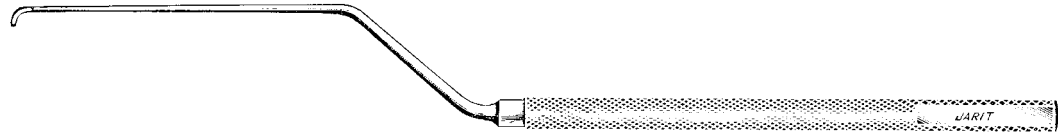

**Yasargil Instruments, Round Bayonet Handle**  
7 1/4" (185mm)

Catalog #	Description
-----------	-------------

277-217	Arachnoid knife
---------	-----------------



277-220	Raspatory, light curve
---------	------------------------

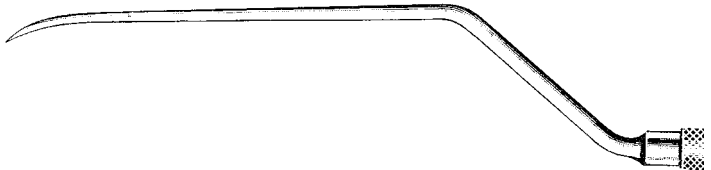

277-221	Raspatory, forward cutting
---------	----------------------------



277-222	Raspatory, backward cutting
---------	-----------------------------

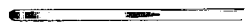

277-225	Curette
---------	---------

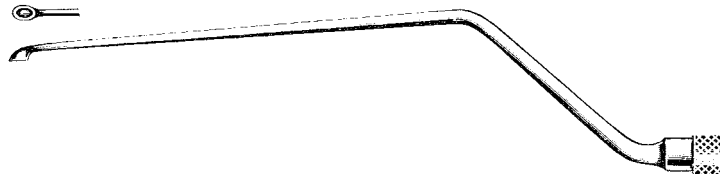

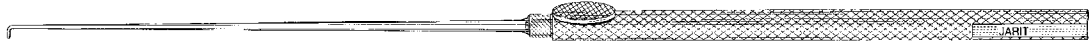

**Krayenbuehl Nerve Hooks**

7¼" (185mm)

Catalog #	Description
277-235	Small



277-236	Large
---------	-------



277-237	Small, ball tip
---------	-----------------



277-238	Large, ball tip
---------	-----------------



### Krayenbuehl Dura Hooks

7¼" (185mm)

Catalog #	Description
277-240	Curved
277-241	Right angle

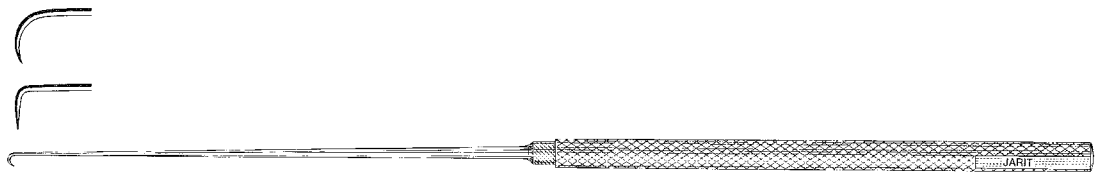

### Krayenbuehl Twist Hooks

7¼" (185mm)

Catalog #	Description
277-244	Small, 1mm diameter
277-245	Large, 1.8mm diameter

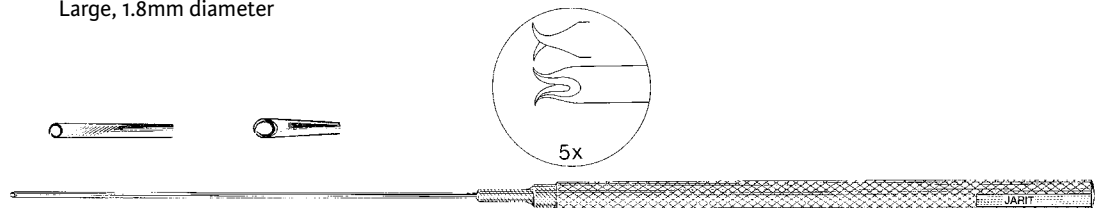

### Yasargil Ligature Carriers

7¼" (185mm)

Catalog #	Description
277-250	Right angle
277-251	Short strong curve
277-252	Long strong curve
277-253	Long light curve

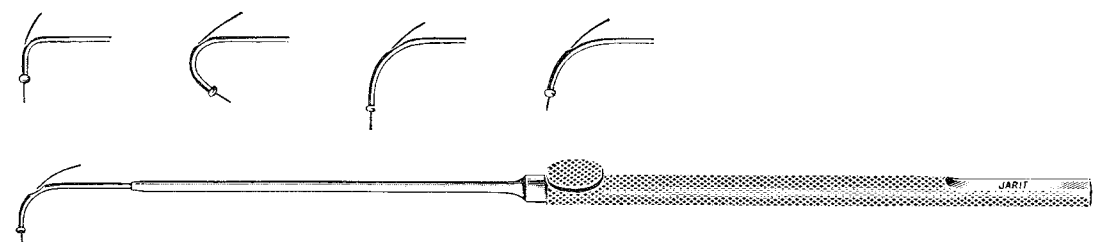

**Rhoton-Type**

dissectors, round, 7½" (190mm)

Catalog #	Description
277-260	1mm blade, #1
277-261	2mm blade, #2
277-262	3mm blade, #3



**Titanium**

**Rhoton-Type**

dissectors, round, 7½" (190mm)

Catalog #	Description
277-260TI	1mm blade, #1
277-261TI	2mm blade, #2
277-262TI	3mm blade, #3



**Rhoton-Type**

elevators, 7½" (190mm)

Catalog #	Description
277-263	Curved, #4
277-264	Angled, #5



**Titanium**

**Rhoton-Type**

elevators, 7½" (190mm)

Catalog #	Description
277-263TI	Curved, #4
277-264TI	Angled, #5



**Rhoton-Type**

spatula-dissectors, 7½" (190mm)

Catalog #	Description
277-265	Small, #6
277-266	Medium, #7
277-267	Large, #8



**Titanium**

**Rhoton-Type**  
spatula-dissectors, 7½" (190mm)

Catalog #	Description
277-265TI	Small, #6
277-266TI	Medium, #7
277-267TI	Large, #8



**Rhoton-Type**  
hooks, 7½" (190mm)

Catalog #	Description
277-268	90° angle, semi-sharp, #9
277-269	90° angle, blunt, #10
277-270	45° angle, semi-sharp, #11



**Titanium**

**Rhoton-Type**  
hooks, 7½" (190mm)

Catalog #	Description
277-268TI	90° angle, semi-sharp, #9
277-269TI	90° angle, blunt, #10
277-270TI	45° angle, semi-sharp, #11



**Rhoton-Type**  
needle, 7½" (190mm)

Catalog #	Description
277-271	Straight, #12



**Titanium**

**Rhoton-Type**  
needle, 7½" (190mm)

Catalog #	Description
277-271TI	Straight, #12

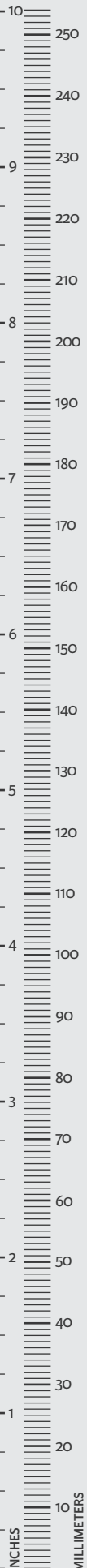



**Rhoton-Type**

curettes, 7½" (190mm)

Catalog #	Description
277-272	Straight, #13
277-273	Angled, #14



**Titanium**

**Rhoton-Type**

curettes, 7½" (190mm)

Catalog #	Description
277-272TI	Straight, #13
277-273TI	Angled, #14



**Rhoton-Type**

ball-dissectors, round, 7½" (190mm)

Catalog #	Description
277-274	90° angle, 3mm, #16



**Titanium**

**Rhoton-Type**

ball-dissectors, round, 7½" (190mm)

Catalog #	Description
277-274TI	90° angle, 3mm, #16
277-276TI	Straight, #15
277-277TI	90° angle, 5mm, #17
277-278TI	40° angle, 4mm, #18
277-279TI	40° angle, 8mm, #19



**Rhoton-Type Instrument Rack**

Catalog #	Description
277-275	10" x 8" x 1" (253mm x 201mm x 25mm), for 15 stainless steel or titanium instruments, 277-260 through 277-274

Catalog #	Description
277-275TI	10" x 8¾" x 1" (253mm x 223mm x 25mm), for 19 stainless steel or titanium instruments, 277-260TI through 277-279TI

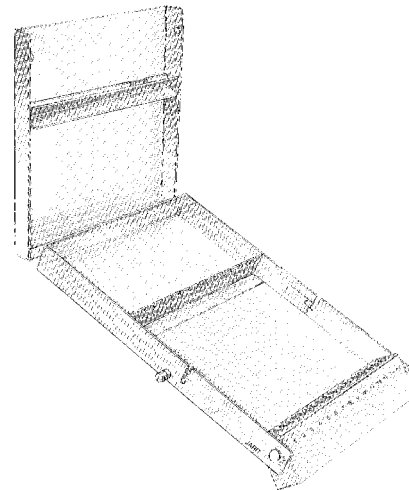

**Rhoton-Type Micro Forceps**

5⅜" (135mm) shaft, 1mm cup

Catalog #	Description
277-290	Straight
277-291	Angled right
277-292	Angled left

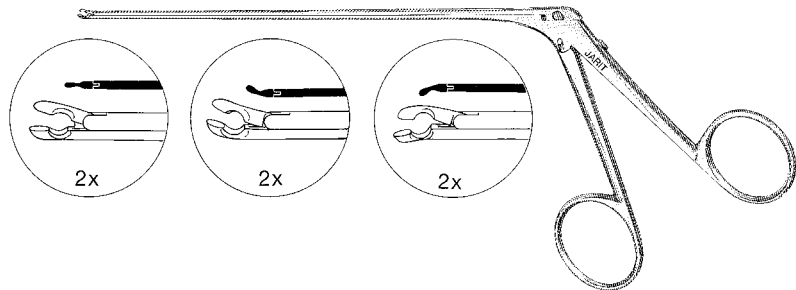

**Rhoton-Type Micro Forceps**

5⅜" (135mm) shaft, 2mm cup

Catalog #	Description
277-295	Straight

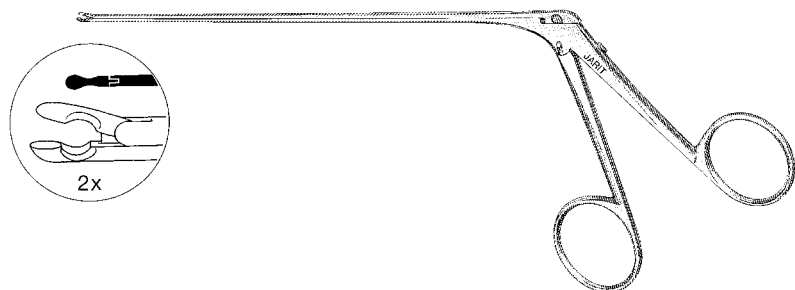

**Jarit Stardust® Needle Holders**

Unique metallurgical process bonds Tungsten Carbide particles to the jaws.  
Extra hardness assures durability and firm grip without damaging needles.

**Jarit Stardust Needle Holders**

Tungsten Carbide coated jaws, round handles,  
1.2mm delicate jaw needle holders, for 6.0 and 7.0 sutures

straight delicate jaws,  
without catch

Catalog #	Description
278-092	7¼" (183mm)
278-094	8¼" (210mm)
278-096	9" (230mm)

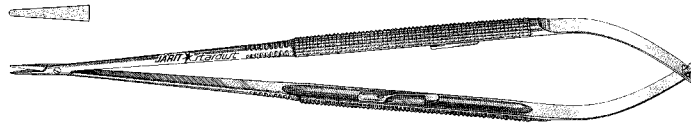

straight delicate jaws,  
with catch

Catalog #	Description
278-093	7¼" (183mm)
278-095	8¼" (210mm)
278-097	9" (230mm)

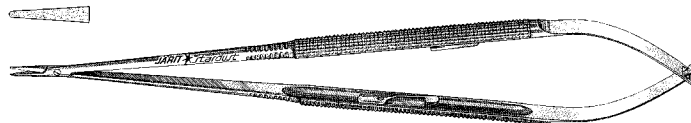

curved delicate jaws,  
without catch

Catalog #	Description
278-100	7¼" (184mm)
278-102	8" (204mm)
278-104	9" (230mm)

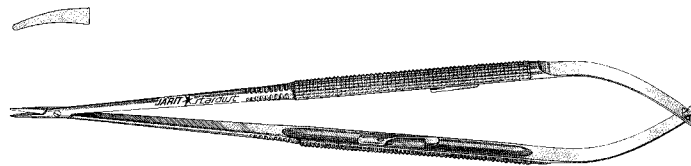

curved delicate jaws,  
with catch

Catalog #	Description
278-101	7" (179mm)
278-103	8" (204mm)
278-105	9" (230mm)

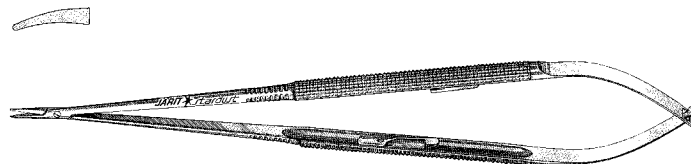

### Jarit Stardust Needle Holders

Tungsten Carbide coated jaws, round handles,  
0.9mm micro jaw needle holders, for 8.0, 9.0, and 10.0 sutures

straight micro jaws,  
without catch

Catalog #	Description
278-110	7" (179mm)
278-112	8" (204mm)
278-114	9" (230mm)

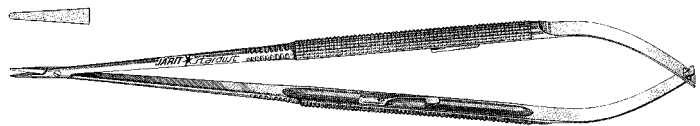

straight micro jaws,  
with catch

Catalog #	Description
278-111	7" (179mm)
278-113	8" (204mm)
278-115	9" (230mm)

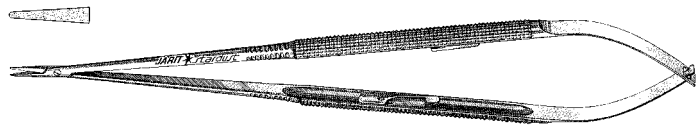

curved micro jaws,  
without catch

Catalog #	Description
278-116	7" (179mm)
278-118	8" (204mm)
278-120	9" (230mm)

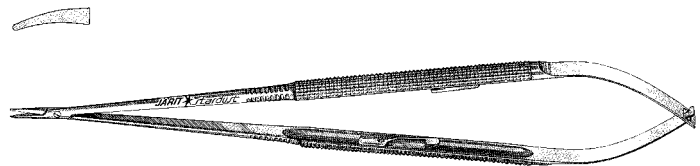

curved micro jaws,  
with catch

Catalog #	Description
278-117	7" (179mm)
278-119	8" (204mm)
278-121	9" (230mm)

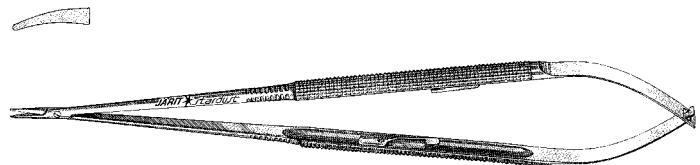

**Jacobson Micro Stardust Needle Holders**

Tungsten Carbide coated jaws, flat serrated handles, 1.3mm delicate needle holders, for 5.0 and 6.0 suture

Catalog #	Description
278-180	7" (178mm), straight jaws, with catch
278-183	7" (180mm), straight jaws, without catch
278-181	8½" (216mm), straight jaws, with catch
278-184	8½" (216mm), straight jaws, without catch
278-182	8½" (216mm), curved jaws, with catch
278-185	8½" (216mm), curved jaws, without catch
278-186	9½" (240mm), straight jaws, with catch



**Jacobson Micro Stardust Needle Holders**

Tungsten Carbide coated jaws, round handles, 1.2mm tip, low profile box lock, heavy pattern needle holders, for 5.0 and 6.0 sutures

Catalog #	Description
278-060	6" (155mm), straight jaws, with catch
278-061	6" (155mm), straight jaws, without catch
278-062	6" (155mm), curved jaws, with catch
278-063	6" (155mm), curved jaws, without catch



**Castroviejo Micro Stardust Needle Holders, with catch**

straight jaws, delicate 1.5mm tip

Catalog #	Description
278-040	5¾" (147mm), round handle
278-050	5½" (140mm), flat handle

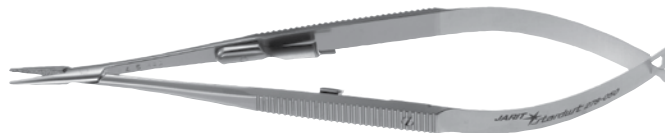

**Titanium**

**Jarit Stardust Needle Holders**

titanium, Tungsten Carbide coated jaws

straight delicate jaws  
with catch

Catalog #	Description
278-080TI	7" (180mm)
278-082TI	8¼" (210mm)



straight, delicate,  
round with catch

Catalog #	Description
278-093TI	7" (180mm)
278-095TI	7¾" (200mm)
278-097TI	10" (255mm)



straight, micro,  
round without catch

Catalog #	Description
278-108TI	5⅞" (148mm)
278-111TI	7" (178mm)
278-113TI	7¾" (200mm)



**Jacobson Micro Stardust Needle Holders**

Tungsten Carbide coated jaws, for larger needles,  
recommended for use with 2.0, 3-0, and 4.0 suture

Catalog #	Description
278-125NL	6¾" (169mm), straight, flat serrated handle
278-126NL	6¾" (169mm), curved, flat serrated handle
278-125	6¾" (169mm), straight, flat serrated handle, with catch
278-126	6¾" (169mm), curved, flat serrated handle, with catch

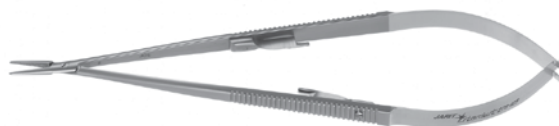

**Jacobson Micro Stardust Needle Holders**

Tungsten Carbide coated jaws, for larger needles, recommended for use with 2.0, 3-0, and 4.0 suture

Catalog #	Description
278-130NL	7½" (190mm), straight, round handle
278-132NL	9" (229mm), straight, round handle
278-134NL	9¾" (250mm), straight, round handle



**Jacobson Micro Stardust Needle Holders**

Tungsten Carbide coated jaws, for larger needles, recommended for use with 2.0, 3-0, and 4.0 suture

Catalog #	Description
278-131NL	7½" (190mm), curved, round handle
278-133NL	9" (229mm), curved, round handle
278-135NL	9¾" (250mm), curved, round handle

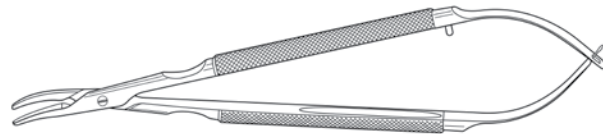

**Jacobson Micro Stardust Needle Holders**

Tungsten Carbide coated jaws, for larger needles, recommended for use with 2.0, 3-0, and 4.0 suture

Catalog #	Description
278-130	7½" (190mm), straight, round handle with catch
278-132	9" (229mm), straight, round handle with catch
278-134	9¾" (250mm), straight, round handle with catch



**Jacobson Micro Stardust Needle Holders**

Tungsten Carbide coated jaws, for larger needles, recommended for use with 2.0, 3-0, and 4.0 suture

Catalog #	Description
278-131	7½" (190mm), curved, round handle with catch
278-133	9" (229mm), curved, round handle with catch
278-135	9¾" (250mm), curved, round handle with catch



**Jarit Stardust® Micro Suture Forceps**

A matched set of forceps designed for tissue manipulation and needle guide.  
Unique metallurgical process bonds Tungsten Carbide particles to the jaws.  
Extra hardness assures durability and firm grip without damaging needles.

**Jarit Stardust Micro Suture Forceps**

Tungsten Carbide coated jaws, round handles

straight with tying platform

Catalog #	Description
279-100	7¼" (184mm)
279-101	8¼" (210mm)
279-102	9" (229mm)



curved, with tying platform

Catalog #	Description
279-105	7¼" (184mm)
279-106	8¼" (210mm)
279-107	9" (229mm)



**Jarit Stardust Micro Forceps**

round handle, 0.8mm micro DeBakey tips

Catalog #	Description
279-149	7¼" (181mm)



**Jarit Stardust Micro Forceps**

round handle, delicate, 1mm platform tips  
straight with tying platform

Catalog #	Description
279-150	7¼" (181mm), 1 x 2 teeth





### Jarit Stardust Micro Ring Forceps

delicate, 1mm ring tips

Catalog #	Description
279-110	7¼" (184mm), straight
279-130	7¼" (181mm), curved
279-111	8¼" (210mm)
279-131	8¼" (210mm), curved
279-112	9" (229mm)

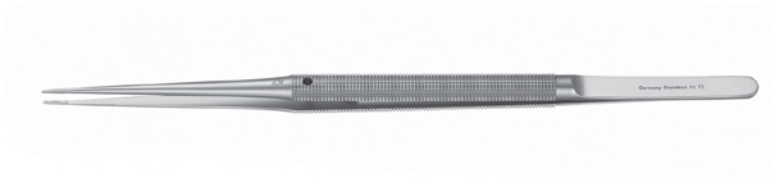

### Dennis Micro Forceps

round handle, counter balance, delicate, 1mm Stardust platform tips

Catalog #	Description
279-158	7" (178mm), straight
279-159	7" (178mm), curved
279-125	8¼" (212mm), straight



### Dennis Micro Ring Forceps

round handle, counter balance, delicate, 1mm Stardust tips

Catalog #	Description
279-113	6" (152mm), straight
279-114	6" (152mm), curved
279-115	7¼" (186mm), straight
279-116	7¼" (186mm), curved
279-117	8¼" (209mm), straight
279-118	8¼" (209mm), curved
279-119	9" (230mm), straight
279-120	9" (230mm), curved
279-121	10" (254mm), straight
279-122	10" (254mm), curved



**Titanium**

**Jarit Stardust Micro Suture Forceps**

titanium, Tungsten Carbide coated, round handles with counter-balance

straight with tying platform

Catalog #	Description
279-100TI	7¼" (184mm)
279-101TI	8¼" (210mm)
279-102TI	9" (229mm)



micro ring (1.0mm OD x 0.5mm ID)

Catalog #	Description
279-110TI	7¼" (181mm)
279-111TI	8¼" (210mm)
279-112TI	9" (229mm)



**Integra**<sup>™</sup>  
Neurosurgical/  
Spinal Instruments  
and General Surgical  
Instruments

**Micro Kerrison Rongeurs**

7" (178mm) shaft, 90° up-bite,  
small improved handle

Catalog #	Description
280-040	1mm bite
280-050	2mm bite
280-051	3mm bite
280-052	4mm bite
280-053	5mm bite
280-054	6mm bite

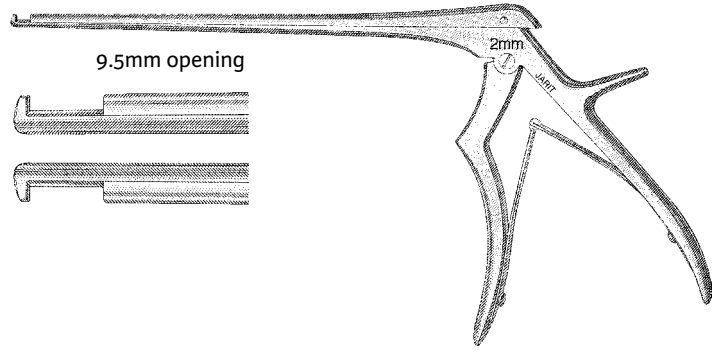

7" (178mm) shaft, 90° down-bite,  
small improved handle

Catalog #	Description
280-055	2mm bite
280-056	3mm bite
280-057	4mm bite
280-058	5mm bite
280-059	6mm bite

**Micro Kerrison Rongeurs**

8" (203mm) shaft, 90° up-bite,  
small improved handle

Catalog #	Description
281-040	1mm bite
281-050	2mm bite
281-051	3mm bite
281-052	4mm bite
281-053	5mm bite
281-054	6mm bite

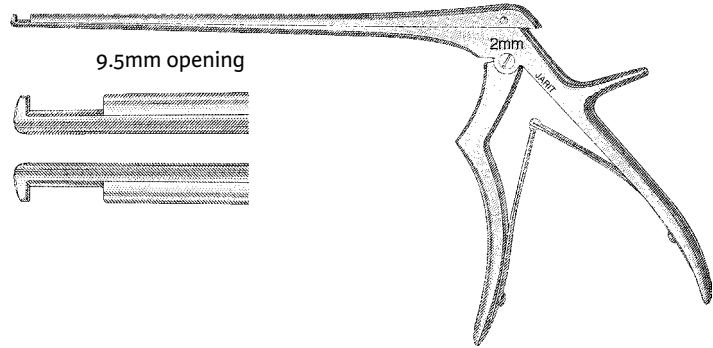

8" (203mm) shaft, 90° down-bite,  
small improved handle

Catalog #	Description
281-055	2mm bite
281-056	3mm bite
281-057	4mm bite
281-058	5mm bite
281-059	6mm bite

**Replacement Parts**

Catalog #	Description
280-SPS-050	Replacement Spring and Screw
280-HSC-050	Replacement Handle Screw pkg/3ea

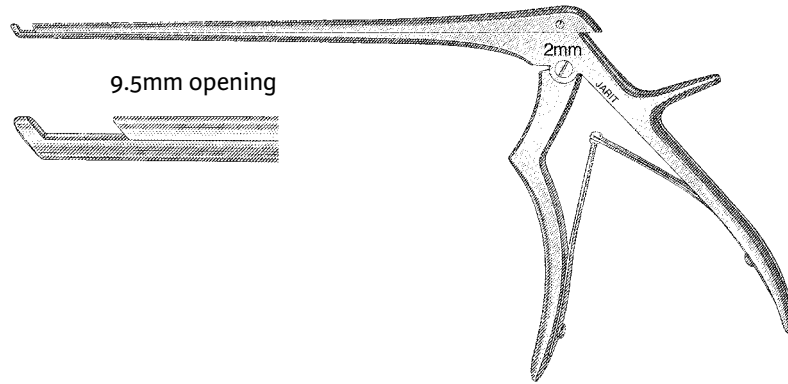

**Micro Kerrison Rongeurs**

7" (178mm) shaft, 40° forward angle, small improved handle

Catalog #	Description
280-041	1mm bite
280-060	2mm bite
280-061	3mm bite
280-062	4mm bite
280-063	5mm bite
280-064	6mm bite

**Micro Kerrison Rongeurs**

8" (203mm), 40° forward angle, small improved handle

Catalog #	Description
281-041	1mm bite
281-060	2mm bite
281-061	3mm bite
281-062	4mm bite
281-063	5mm bite
281-064	6mm bite

**Micro Kerrison Rongeurs**

9" (229mm), 40° forward angle, small improved handle

Catalog #	Description
282-060	2mm bite
282-061	3mm bite
282-062	4mm bite
282-063	5mm bite
282-064	6mm bite

**Micro Kerrison Rongeurs**

10" (279mm), 40° forward angle, small improved handle

Catalog #	Description
283-060	2mm bite
283-061	3mm bite
283-062	4mm bite
283-063	5mm bite
283-064	6mm bite

**Micro Kerrison Rongeurs**

11" (254mm), 40° forward angle, small improved handle

Catalog #	Description
284-060	2mm bite
284-061	3mm bite
284-062	4mm bite
284-063	5mm bite
284-064	6mm bite

**Replacement Parts**

Catalog #	Description
280-SPS-050	Replacement Spring and Screw
280-HSC-050	Replacement Handle Screw Pkg/3ea

**Micro Kerrison Cervical Rongeurs, Thin Footplate**

7" (178mm), 40° forward angle,  
small improved handle

Catalog #	Description
280-060TF	2mm bite
280-061TF	3mm bite
280-062TF	4mm bite
280-063TF	5mm bite

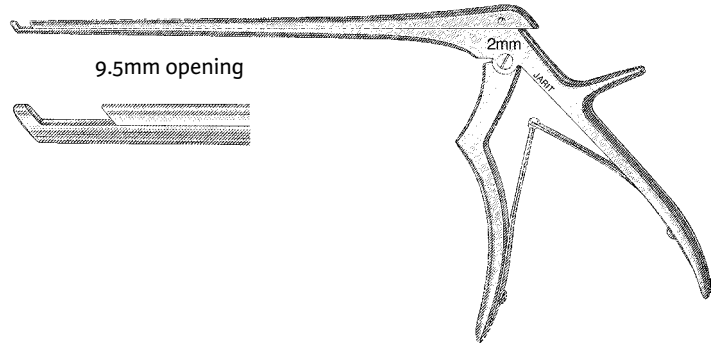

**Micro Kerrison Cervical Rongeurs, Thin Footplate**

8" (203mm), 40° forward angle,  
small improved handle

Catalog #	Description
281-060TF	2mm bite
281-061TF	3mm bite
281-062TF	4mm bite
281-063TF	5mm bite

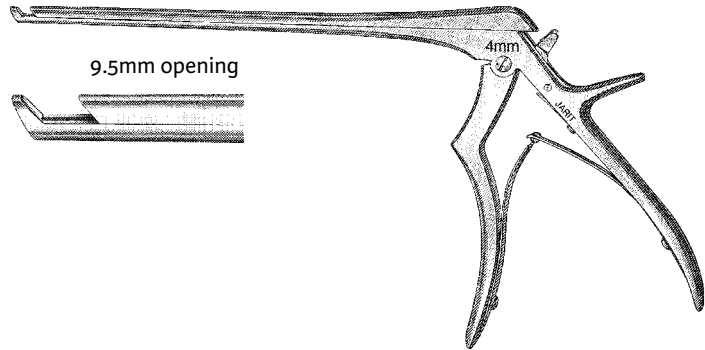

**Replacement Parts**

Catalog #	Description
280-SPS-TF	Replacement Spring and Screw



**Jarit Detach® Micro Kerrison Cervical Rongeurs**

7" (178mm) shaft, thin footplate,  
40° forward angle, small improved handle

Catalog #	Description
280-040DT	1mm bite
280-060DT	2mm bite
280-061DT	3mm bite
280-062DT	4mm bite
280-063DT	5mm bite

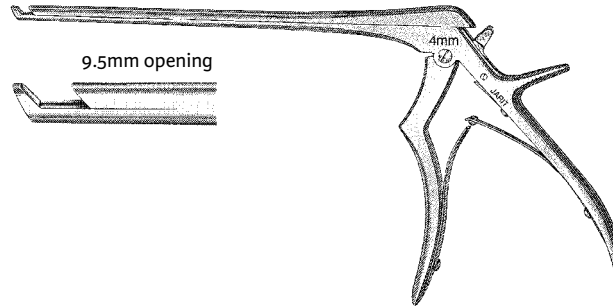

**Jarit Detach® Micro Kerrison Cervical Rongeurs**

8" (203mm) shaft, thin footplate,  
40° forward angle, small improved handle

Catalog #	Description
281-040DT	1mm bite
281-060DT	2mm bite
281-061DT	3mm bite
281-062DT	4mm bite
281-063DT	5mm bite

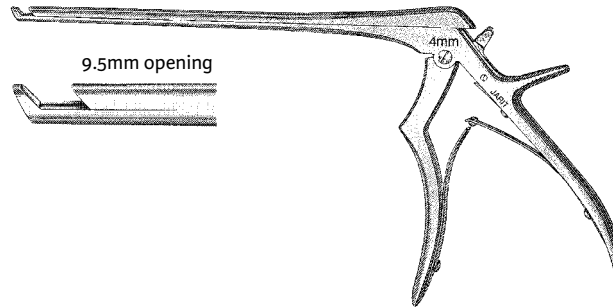

**Spurling- Kerrison Rongeurs**

7" (178mm) shaft, 40° forward angle,  
cherry-type handle

Catalog #	Description
280-160	2mm bite
280-161	3mm bite
280-162	4mm bite
280-163	5mm bite
280-164	6mm bite

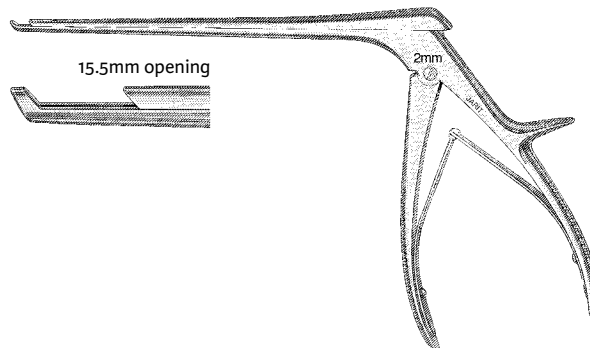

**Spurling- Kerrison Rongeurs**

8" (203mm) shaft, 40° forward angle,  
cherry-type handle

Catalog #	Description
280-199	2mm bite
280-200	3mm bite
280-201	4mm bite
280-202	5mm bite
280-203	6mm bite

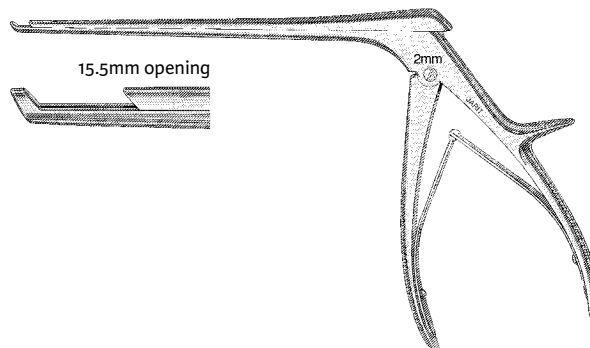

**Spurling- Kerrison Rongeurs**

7" (178mm) shaft, 90° up-bite,  
large improved handle

Catalog #	Description
280-209	2mm bite
280-210	3mm bite
280-211	4mm bite
280-212	5mm bite
280-213	6mm bite

**Spurling- Kerrison Rongeurs**

8" (203mm) shaft, 90° up-bite,  
large improved handle

Catalog #	Description
280-229	2mm bite
280-230	3mm bite
280-231	4mm bite
280-232	5mm bite
280-233	6mm bite

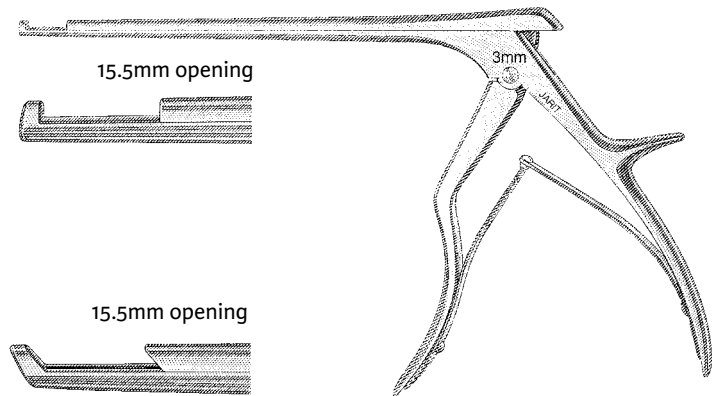

**Spurling- Kerrison Rongeurs**

7" (178mm) shaft, 40° forward angle,  
large improved handle

Catalog #	Description
280-219	2mm bite
280-220	3mm bite
280-221	4mm bite
280-222	5mm bite
280-223	6mm bite

**Spurling- Kerrison Rongeurs**

8" (203mm) shaft, 40° forward angle,  
large improved handle

Catalog #	Description
280-239	2mm bite
280-240	3mm bite
280-241	4mm bite
280-242	5mm bite
280-243	6mm bite

**Spurling- Kerrison Rongeurs**

9" (229mm) shaft, 40° forward angle,  
large improved handle

Catalog #	Description
281-239	2mm bite
281-240	3mm bite
281-241	4mm bite
281-242	5mm bite
281-243	6mm bite

**Spurling- Kerrison Rongeurs**

11" (280mm) shaft, 40° forward angle,  
large improved handle

Catalog #	Description
283-239	2mm bite
283-240	3mm bite
283-241	4mm bite
283-242	5mm bite
283-243	6mm bite





**Spurling- Kerrison Rongeurs**

8" (203mm) shaft, 90° down-bite,  
large improved handle

Catalog #	Description
280-234	2mm bite
280-235	3mm bite
280-236	4mm bite
280-237	5mm bite
280-238	6mm bite

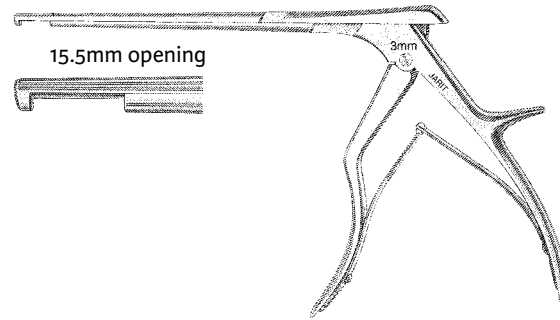

**Ferris-Smith Laminectomy Rongeurs**

7" (175mm), 40° forward-angle

Catalog #	Description
280-286	3mm bite
280-288	5mm bite

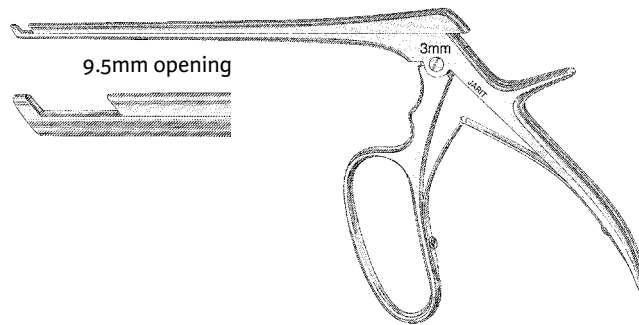

**Ferris-Smith Laminectomy Rongeurs**

8" (203mm), 40° forward-angle

Catalog #	Description
280-290	3mm bite
280-292	5mm bite

**Hardy Sella Punches**

7" (178mm) shaft, 2mm bite,  
small improved handle

Catalog #	Description
280-295	90° up-bite
280-296	40° up-bite
280-297	90° down-bite
280-298	40° down-bite

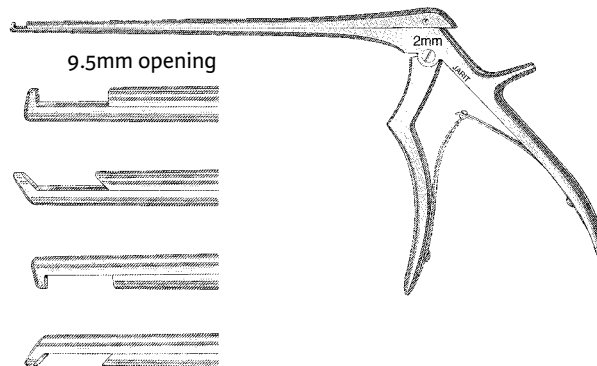

**Cushing Pituitary Rongeurs**

2 x 10mm bite

5" (127mm) shaft

Catalog #	Description
280-400	Straight
280-401	Up-angled
280-402	Down-angled

6" (150mm) shaft

Catalog #	Description
280-380	Straight
280-381	Up-angled
280-382	Down-angled

7" (180mm) shaft

Catalog #	Description
280-405	Straight
280-406	Up-angled
280-407	Down-angled

9" (230mm) shaft

Catalog #	Description
281-405	Straight
281-406	Up-angled
281-407	Down-angled

11" (280mm) shaft

Catalog #	Description
282-405	Straight
282-406	Up-angled
282-407	Down-angled

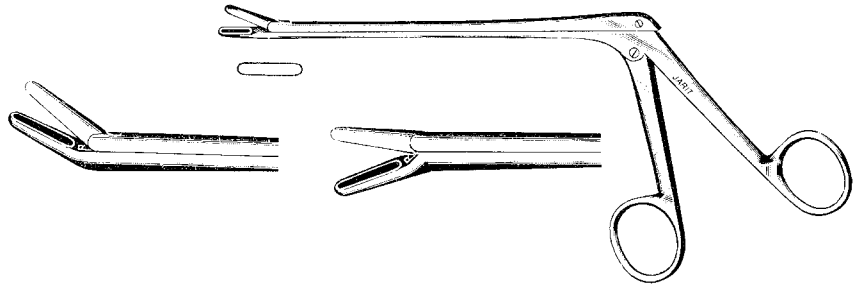

**Love Gruenwald Pituitary Rongeurs**

3 x 10mm bite

5" (127mm) shaft

Catalog #	Description
280-410	Straight
280-411	Up-angled
280-412	Down-angled

6" (150mm) shaft

Catalog #	Description
280-383	Straight
280-384	Up-angled
280-385	Down-angled

7" (180mm) shaft

Catalog #	Description
280-415	Straight
280-416	Up-angled
280-417	Down-angled

9" (230mm) shaft

Catalog #	Description
281-415	Straight
281-416	Up-angled
281-417	Down-angled

11" (280mm) shaft

Catalog #	Description
282-415	Straight
282-416	Up-angled
282-417	Down-angled

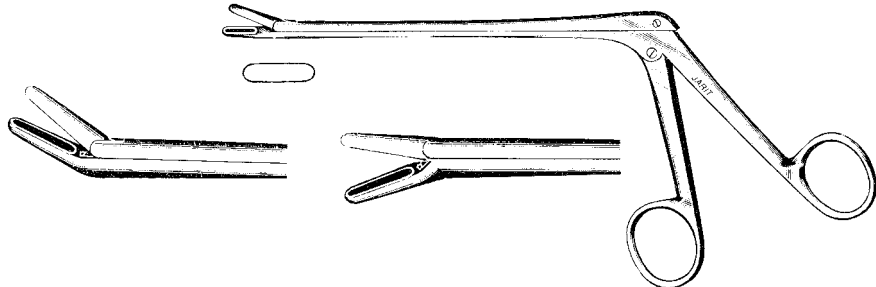

### Spurling Pituitary Rongeurs

4 x 10mm bite

5" (127mm) shaft

Catalog #	Description
280-420	Straight
280-421	Up-angled
280-422	Down-angled

6" (150mm) shaft

Catalog #	Description
280-386	Straight
280-387	Up-angled
280-388	Down-angled

7" (180mm) shaft

Catalog #	Description
280-425	Straight
280-426	Up-angled
280-427	Down-angled

9" (230mm) shaft

Catalog #	Description
281-425	Straight
281-426	Up-angled
281-427	Down-angled

11" (280mm) shaft

Catalog #	Description
282-425	Straight
282-426	Up-angled
282-427	Down-angled

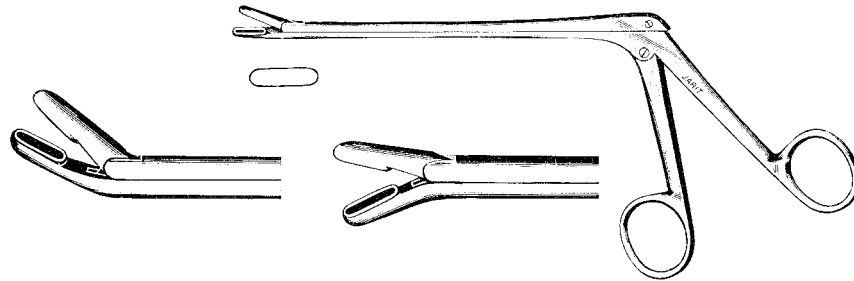

**Schlesinger Rongeurs**

6" (151mm) shaft, serrated jaws

Catalog #	Description
280-430	2 x 10mm bite, straight
280-431	3 x 10mm bite, straight
280-432	4 x 10mm bite, straight

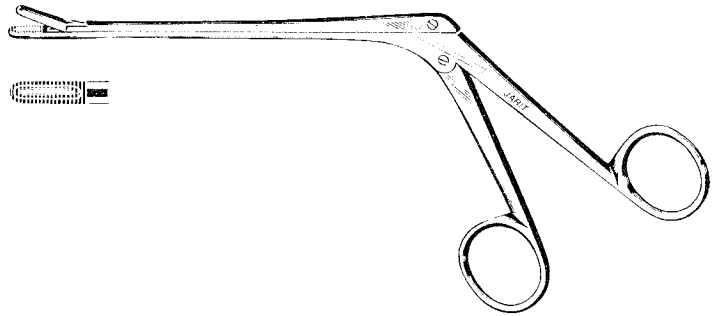

**Cloward Style Rongeurs**

5 3/8" (135mm) shaft, serrated jaws,  
6 x 10mm bite

Catalog #	Description
280-440	Straight
280-441	Up-angled
280-442	Down-angled

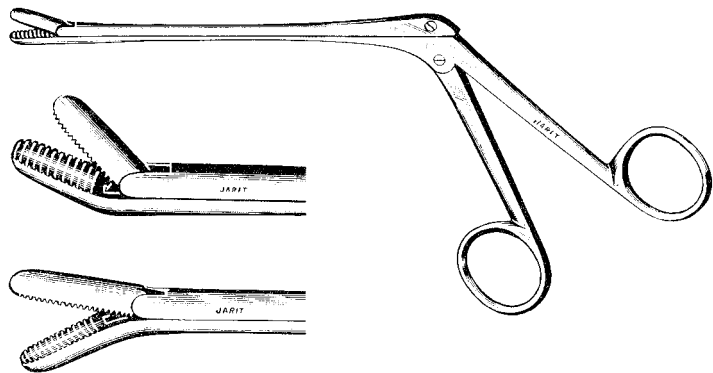

### Wilde Rongeurs

fenestrated jaws, straight

5½" (140mm) working length

7" (180mm) working length

9" (229mm) working length

Catalog #	Description
280-450	4mm bite
280-451	5mm bite
280-452	6mm bite

Catalog #	Description
281-450	4mm bite
281-451	5mm bite
281-452	6mm bite

Catalog #	Description
282-450	4mm bite
282-451	5mm bite
282-452	6mm bite

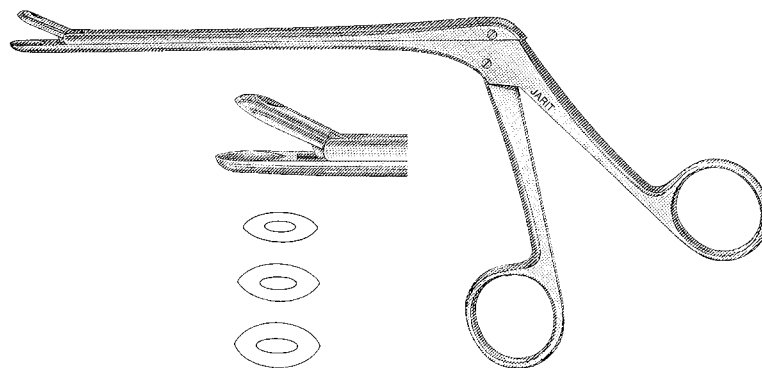

### Wilde Rongeur

Catalog #	Description
280-454	4½" (115mm) working length, 6⅞" (175mm) overall length, up-angled, fenestrated, 5mm x 10mm cup jaws

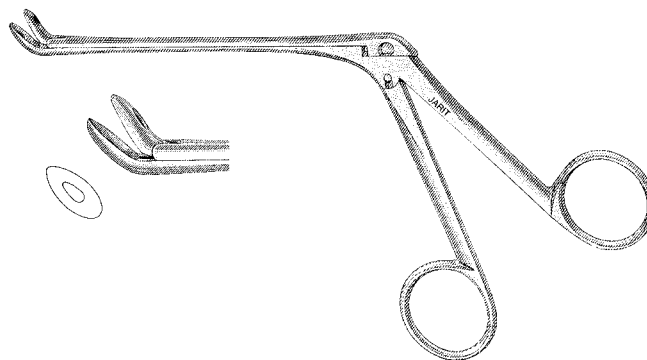

**Jackson Rongeur**

7" (178mm) shaft, fenestrated jaws

Catalog #	Description
280-460	4 x 8mm bite, 7° up-angled

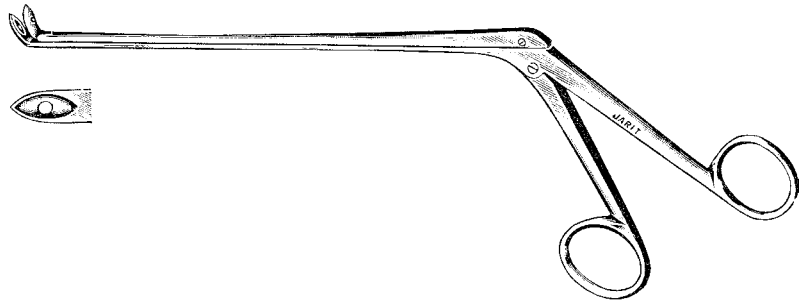

**Peapod (Bead-Type) Forceps**

5 1/2" (140mm) shaft, 45° up-angled

Catalog #	Description
280-465	2 x 7mm bite
280-466	2.5 x 7mm bite
280-467	3 x 7mm bite

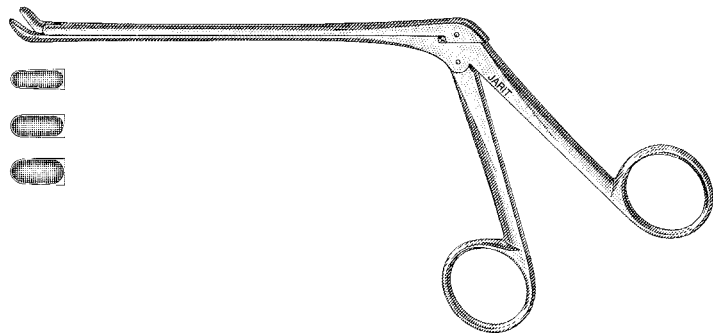

**Takahashi Rongeur**

5" (130mm) shaft

Catalog #	Description
280-470	4 x 10mm bite

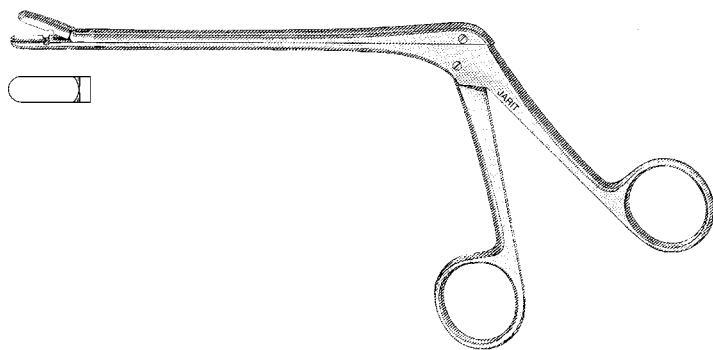

**Ferris-Smith Cup Jaw Rongeurs**

7" (177mm) shaft, straight

Catalog #	Description
280-500	2 x 10mm bite
280-501	3 x 10mm bite
280-502	4 x 10mm bite
280-503	4 x 8mm bite
280-504	6 x 10mm bite
280-505	6 x 12mm bite

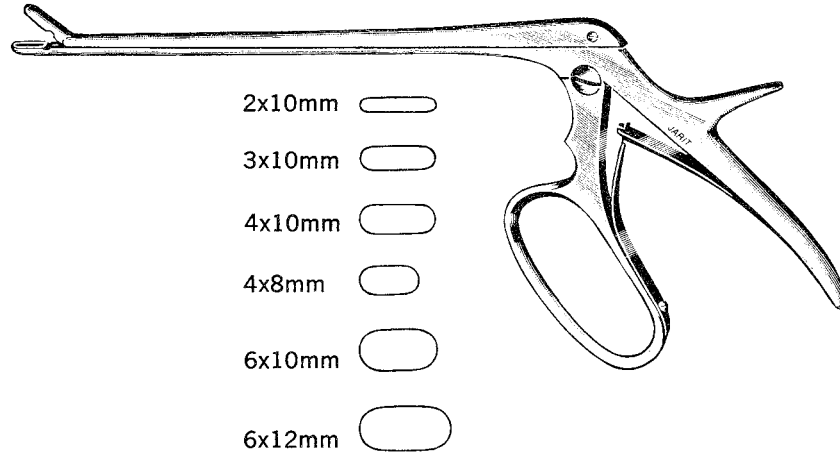

**Ferris-Smith Cup Jaw Rongeurs**

7" (177mm) shaft, up-angled

Catalog #	Description
280-510	2 x 10mm bite
280-511	3 x 10mm bite
280-512	4 x 10mm bite
280-514	6 x 10mm bite

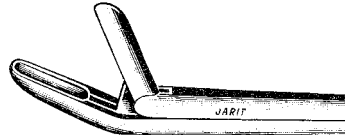

**Ferris-Smith Cup Jaw Rongeurs**

7" (177mm) shaft, down-angled

Catalog #	Description
280-515	2 x 10mm bite
280-516	3 x 10mm bite
280-517	4 x 10mm bite

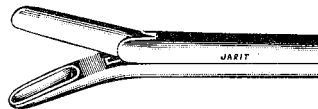

**Stokey Cranial Rongeur**

7½" (190mm)

Catalog #	Description
280-530	3.6mm bite

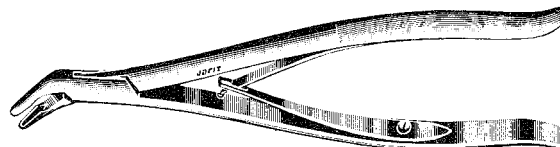

### Craig Vertebral Biopsy Set

Catalog #	Description
<b>280-550</b>	Biopsy Set Includes:
<b>280-551</b>	1 socket wrench
<b>280-552</b>	1 needle, 20 gauge
<b>280-553</b>	1 needle, 22 gauge
<b>280-554</b>	1 calibrated cannula
<b>280-555</b>	2 trephine cutters, with teeth
<b>280-556</b>	1 stylet pusher
<b>280-557</b>	1 twist hook
<b>280-558</b>	2 trocars, blunt, calibrated
<b>280-559</b>	1 instrument rack

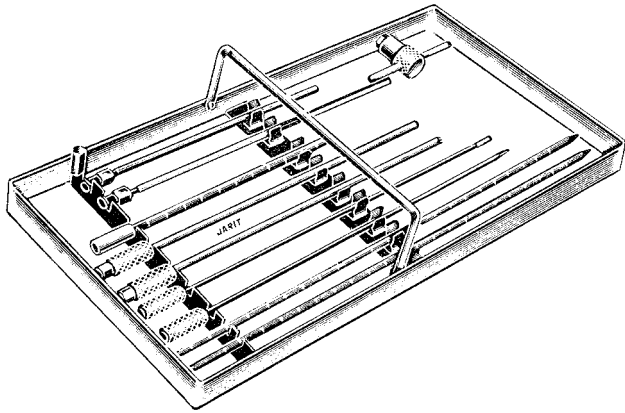



**Dandy (Cairns) Scalp Forceps**

5¾" (145mm)

Catalog #	Description
285-100	Curved to side

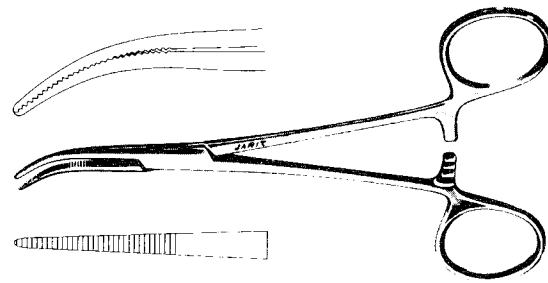

**Dandy (Baby) Scalp Forceps**

4" (102mm)

Catalog #	Description
285-101	Curved to side

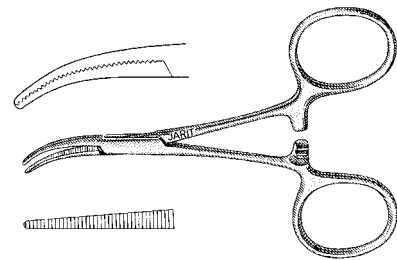

**Petit-Point® Jacobson Mosquito Forceps**

4⅞" (124mm)

Catalog #	Description
105-088	Straight
105-089	Curved

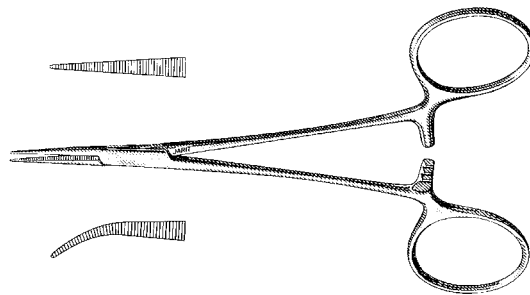

**Petit-Point Jacobson Mosquito Forceps**

7¼" (185mm), serrated jaws

Catalog #	Description
105-092	Slightly curved
105-093	Fully curved



**Petit-Point Mosquito Forceps**

6" (152mm)

Catalog #	Description
105-098	Straight
105-099	Curved

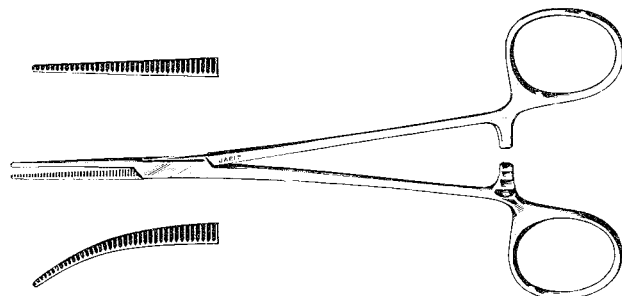

**Gemini Artery Clamp**

Catalog #	Description
140-330	7½" (190mm)
140-331	8¼" (205mm)
140-332	9" (230mm)

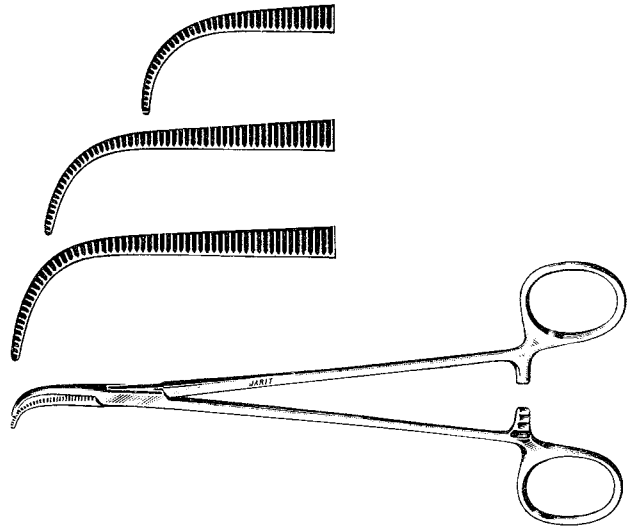

**Adson Hemostatic Forceps, Fine Tips**

Catalog #	Description
285-103	8½" (215mm), straight
285-104	8½" (215mm), curved
285-105	7½" (190mm), straight
285-106	7½" (190mm), curved

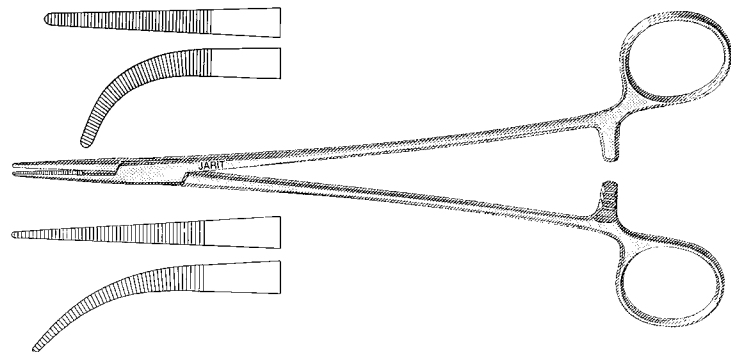

**Petit-Point Mosquito Forceps**

7¼" (184mm)

Catalog #	Description
285-107	Straight
285-108	Curved

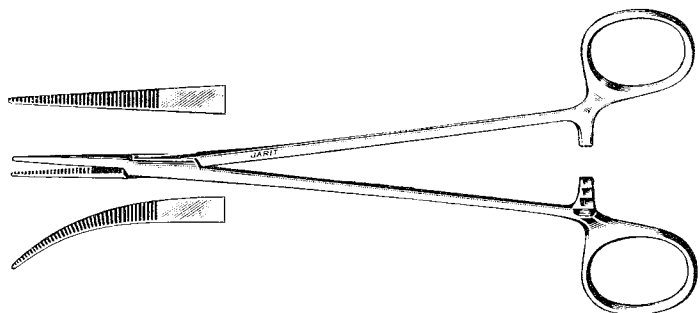

**Decker Microsurgical Rongeurs**

6" (153mm), 2mm x 6mm cup

Catalog #	Description
285-110	Straight
285-111	Curved left

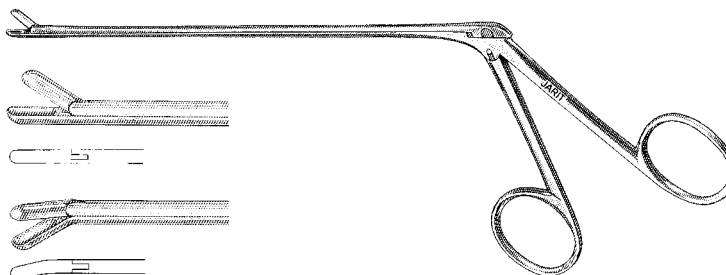

**Decker Microsurgical Scissors**

6" (153mm)

Catalog #	Description
285-112	Straight

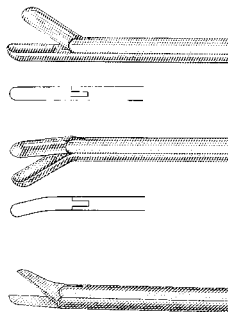

**Williams-Type Dissectomy Forceps**

5 1/2" (140mm)

Catalog #	Description
285-114	2.3mm wide with 1.0mm bite

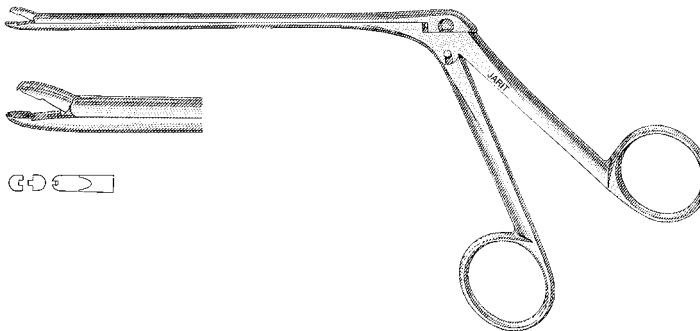

**Hoen Alligator Forceps**

5 1/2" (140mm)

Catalog #	Description
285-115	Serrated jaws, 1 x 2 teeth

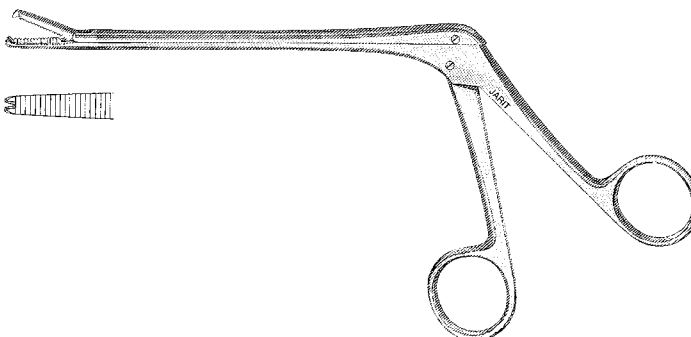

**Adson Dressing Forceps, Serrated, (Matte Finish)**

Manufactured from high grade German surgical stainless steel which is glass beaded to a matte finish

Catalog #	Description
130-230	4¾" (120mm)
130-231	4¾" (120mm), extra delicate, 0.8mm wide tip

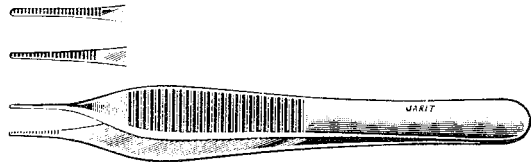

**Adson Dressing Forceps, Serrated, (Satin Finish)**

Manufactured from high grade German surgical stainless steel which is ground and polished to a satin finish

Catalog #	Description
129-230	4¾" (120mm)

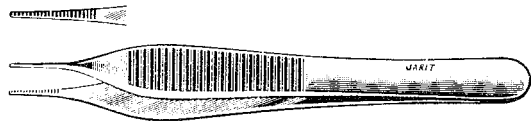

**Adson Dressing Forceps**

Catalog #	Description
130-232	4¾" (120mm), cross serrated tip

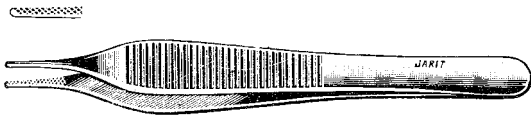

**Adson Tissue Forceps, 1 x 2 teeth, (Matte Finish)**

Manufactured from high grade German surgical stainless steel which is glass beaded to a matte finish

Catalog #	Description
130-234	4¾" (120mm)
130-235	4¾" (120mm), extra delicate, 0.8mm wide tip
130-237	4⅝" (117mm), angled jaw
130-238	4¾" (120mm), with tying platform

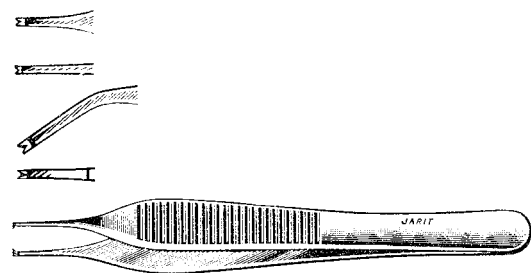

**Adson Tissue Forceps, 1 x 2 teeth, (Satin Finish)**

Manufactured from high grade German surgical stainless steel which is ground and polished to a satin finish

Catalog #	Description
129-234	4¾" (120mm)

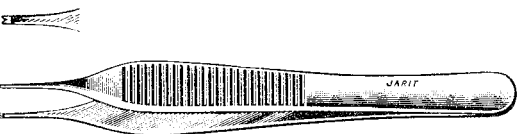

### Adson Tissue Forceps, Carb-Bite

Catalog #	Description
130-236	4¾" (120mm)

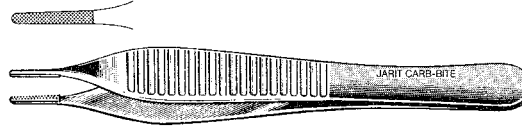

### Adson Dressing Forceps

Catalog #	Description
130-243	4¾" (120mm), cross serrated handle

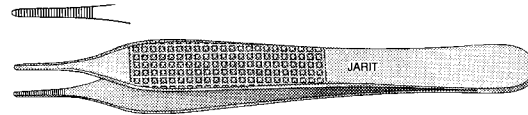

### Adson Tissue Forceps

Catalog #	Description
130-244	4¾" (120mm), 1 x 2 teeth, cross serrated handle

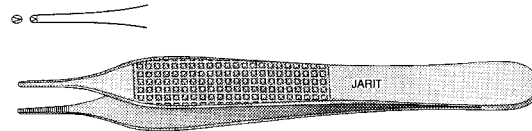

### Adson Tissue Forceps

Catalog #	Description
130-245	4¾" (120mm), 1 x 2 teeth, serrated

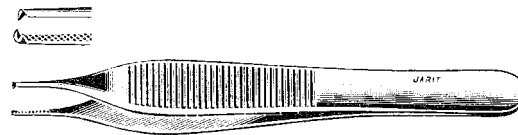

### Broli-Adson Forceps

6" (152mm), 1.2mm tips

Catalog #	Description
130-246	Straight, serrated tips
130-247	Curved, serrated tips
130-248	Straight, Stardust tips
130-249	Straight, 1 x 2 teeth



### Semken Dressing Forceps

serrated

Catalog #	Description
130-275	5" (126mm)
130-276	6" (152mm)



**Semken Tissue Forceps**

Catalog #	Description
130-280	5" (126mm), 1 x 2 teeth
130-281	6" (154mm), 1 x 2 teeth
130-282	5" (126mm), 2 x 3 teeth

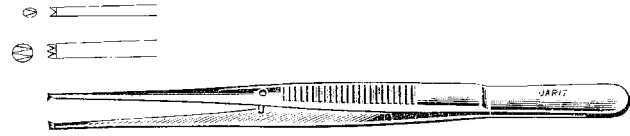

**Hoehn Dressing and Tissue Forceps, Bayonet Handle**

7 3/4" (200mm)

Catalog #	Description
285-116	Serrated
285-117	1 x 2 teeth

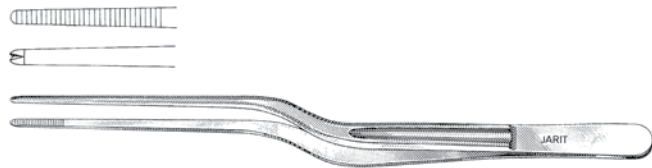

**Brain Dressing and Tissue Forceps**

7" (176mm), delicate

Catalog #	Description
285-118	Serrated
285-119	1 x 2 teeth

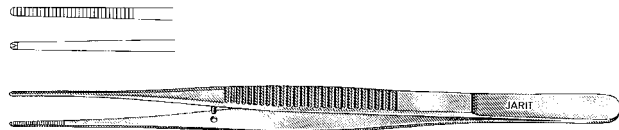

**Cushing Dressing Forceps**

straight, serrated, scraper end

Catalog #	Description
130-400	6 3/4" (170mm), 1.5mm tip
130-445	7 3/4" (200mm), 2mm tip

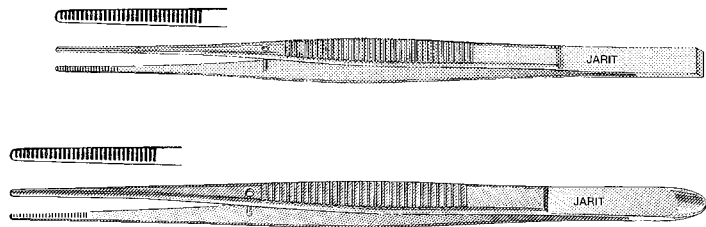

**Cushing Tissue Forceps**

straight, 1 x 2 teeth, scraper end

Catalog #	Description
130-405	6 3/4" (171mm), 1.5mm tip
130-446	7 3/4" (200mm), cross serrated, 2mm tip

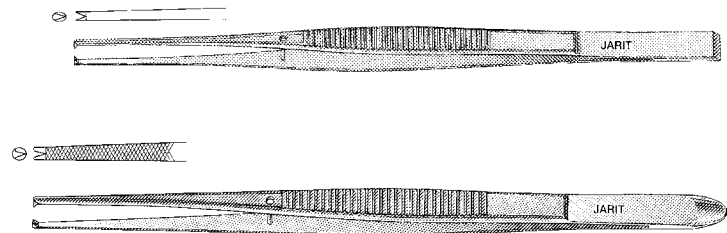

**Cushing Dressing Forceps**

bayonet, serrated, scraper end

Catalog #	Description
130-410	7¼" (183mm), 1.7mm tip
130-420	7¾" (200mm), 1.9mm tip

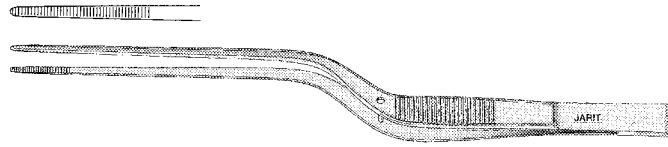

**Cushing Tissue Forceps**

bayonet, 1 x 2 teeth, scraper end

Catalog #	Description
130-415	7¼" (181mm), 1.7mm tip
130-421	7¾" (200mm), 1.7mm tip

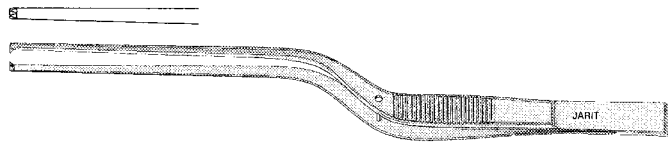

**Cushing Dressing and Tissue Forceps**

Gutsch handle, straight, scraper end

Catalog #	Description
130-425	7" (178mm), serrated, 1.5mm wide tips
130-430	7" (178mm), 1 x 2 teeth, 1.5mm wide tips
130-435	7" (178mm), 1 x 2 teeth, serrated, 1.5mm wide tips



**Cushing Needle and Tissue Pulling Forceps, Carb-Bite**

straight, Gutsch handle, scraper end

Catalog #	Description
122-530	7" (176mm), 1.8mm wide x 12mm long tips
122-535	7" (178mm), delicate, 1.6mm wide x 8mm long tips

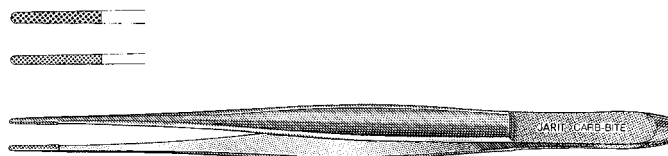

**Cushing Tissue Forceps, Carb-Bite**

Catalog #	Description
130-417	7" (176mm), angled, 1.8mm wide x 12mm long tips, Gutsch handle, scraper end

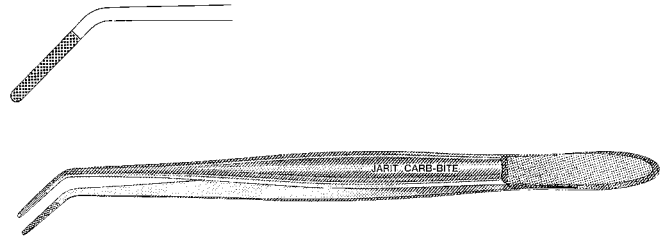

**Cushing Tissue Forceps, Carb-Bite**

Catalog #	Description
130-418	7 1/2" (191mm), bayonet, 1.8mm wide x 14mm long tips, scraper end

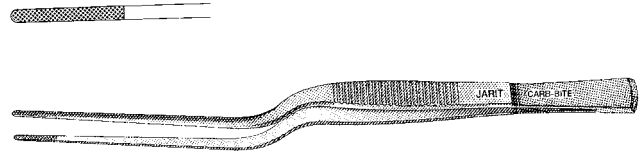

**Cushing-Brown Tissue Forceps**

Catalog #	Description
130-440	6 3/4" (174mm), straight, double row of 9 x 9 delicate teeth, scraper end

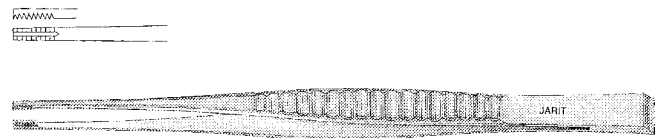

**Cushing-Brown Tissue Forceps**

Catalog #	Description
130-442	7" (180mm), bayonet, double row of 9 x 9 delicate teeth, scraper end

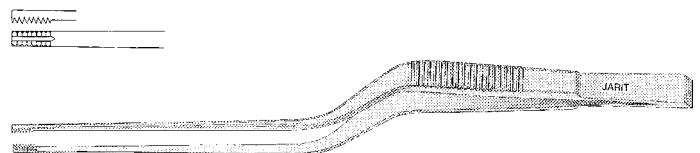



### Gerald Dressing Forceps

narrow, 1.3mm wide tips

Catalog #	Description
285-120	7" (175mm), straight
285-121	7" (175mm), curved
285-122	7½" (192mm), bayonet
285-128	9¼" (233mm), straight

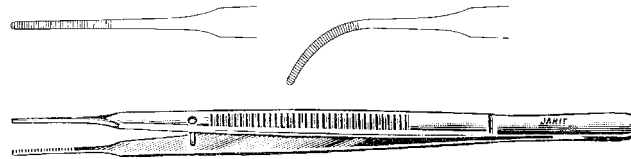

### Gerald Tissue Forceps

narrow, 1 x 2 tips

Catalog #	Description
285-125	7" (176mm), straight
285-127	7½" (192mm), bayonet
285-129	9¼" (233mm), straight



### Gerald Forceps, Cardio-Grip™ (DeBakey Type Teeth)

straight, 1.2mm wide tips

Catalog #	Description
285-126	7" (180mm)
285-132	7¾" (200mm)
285-130	9½" (240mm)

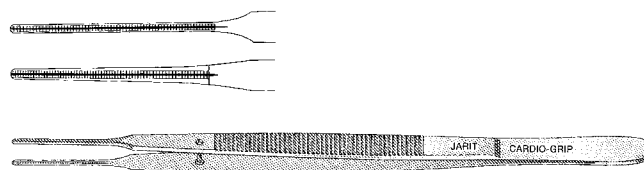

### Gerald Dressing Forceps

1.3mm wide tips

Catalog #	Description
285-135	9⅞" (250mm)

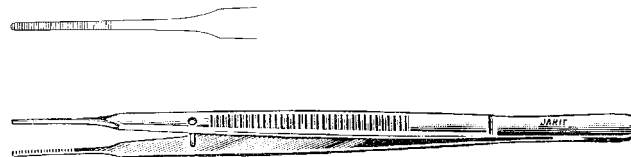

### Adson Dressing Forceps

Catalog #	Description
285-140	7¾" (196mm), bayonet, 2.4mm tips



**D'Errico Dressing and Tissue Forceps, Bayonet Handle**

8¾" (222mm)

Catalog #	Description
285-147	Serrated, 3mm tips
285-148	1 x 2 teeth, 2.5mm tips

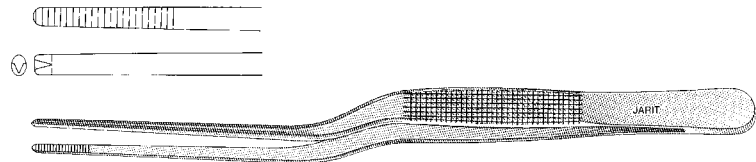

**Adson Hypophyseal Forceps**

bayonet shape, 7.5mm round cup

Catalog #	Description
285-170	9" (229mm), straight
285-171	8¾" (225mm), Curved up
285-172	8¾" (225mm), Curved down

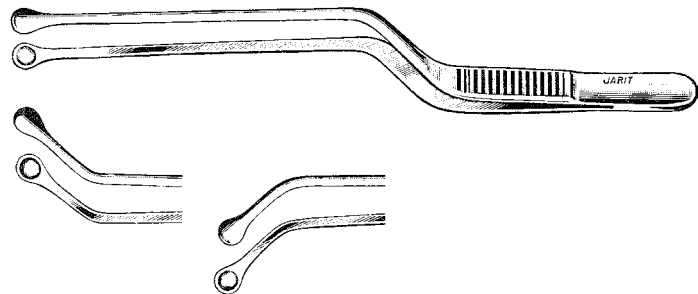

### Semken Bipolar Forceps

Catalog #	Description
285-185	6" (152mm), 1.8mm tip, straight, insulated

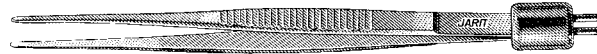

### Cushing Bipolar Forceps

Catalog #	Description
285-186	7 1/4" (184mm), 1.5mm tip, straight, insulated

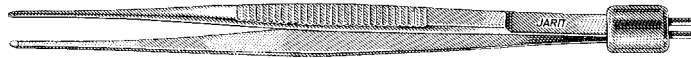

### Cushing Bipolar Forceps

Catalog #	Description
285-187	7 1/4" (184mm), 2.2mm tip, bayonet shaped, insulated

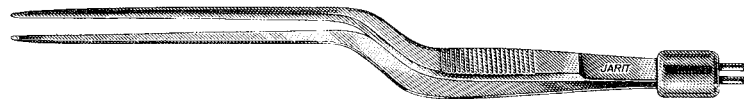

### Cushing Bipolar Forceps

Catalog #	Description
285-188	7 1/4" (184mm), 0.8mm micro-tip, bayonet shaped, insulated

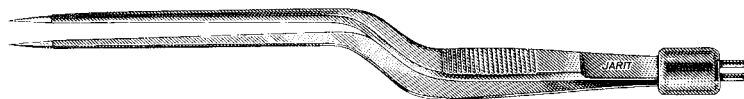

### Jacobson Bipolar Forceps

Catalog #	Description
285-189	6 1/4" (159mm), 0.8mm micro-tip, bayonet shaped, insulated

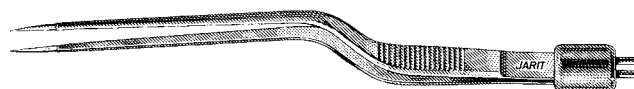

### Gerald Bipolar Forceps

Catalog #	Description
285-190	7 1/4" (184mm), 1mm fine tip, straight, insulated



### Gerald Bipolar Forceps

Catalog #	Description
285-191	7 1/4" (184mm), 1mm fine tip, bayonet shaped, insulated

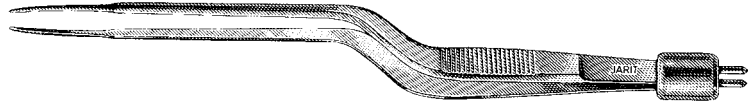

### Cushing Bipolar Forceps

Catalog #	Description
285-192	6" (152mm), 1.3mm tip, bayonet shaped, insulated



### Jeweler-Type Forceps

Catalog #	Description
285-193	4" (102mm), 0.5mm fine tip, insulated



**IMPORTANT:** When disconnecting electrosurgical cables from the generator or instrument, always grasp the cables by the connector only. Never pull the cable by the cord. Do not use instruments or cables if the insulation is not fully intact.

### Bipolar Cord

Catalog #	Description
285-199	Bipolar Cord (10ft)

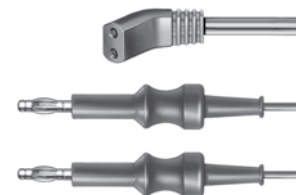

## Disposable Bipolar Forceps

### Jewelers Disposable Bipolar Forcep (insulated)

Catalog #	Description
286-100	4½" (114mm), straight, 0.4mm tip with 12' cord, 10/per



### Jewelers Disposable Bipolar Forcep (non-insulated)

Catalog #	Description
286-101	4½" (114mm), straight, 0.4mm tip with 12' cord, 10/per



### Adson Disposable Bipolar Forceps (insulated)

Catalog #	Description
286-102	4¾" (121mm), smooth, 1.0mm tip with 12' cord, 10/per



### Adson Disposable Bipolar Forceps (non-insulated)

Catalog #	Description
286-103	4¾" (121mm), smooth, 1.0mm tip with 12' cord, 10/per



### Cushing Disposable Bayonet Bipolar Forcep (insulated)

Catalog #	Description
286-104	7½" (190mm), smooth, 3½" (90mm) working length, 0.7mm tip with 12' cord, 10/per



### Cushing Disposable Bayonet Bipolar Forcep (non-insulated)

Catalog #	Description
286-105	7½" (190mm), smooth, 3½" (90mm) working length, 0.7mm tip with 12' cord, 10/per



### Scoville Disposable Bayonet Bipolar Forcep (insulated)

Catalog #	Description
286-106	7¾" (197mm), smooth, 2¾" (70mm) working length, 1.5mm tip with 12' cord, 10/per



## Disposable Bipolar Forceps

### Scoville Disposable Bayonet Bipolar Forcep (non-insulated)

Catalog #	Description
286-107	7¾" (197mm), smooth, 2¾" (70mm) working length, 1.5mm tip with 12' cord, 10/per



### Hardy Disposable Bayonet Bipolar Forcep (insulated)

Catalog #	Description
286-108	8½" (215mm), smooth, 4½" (115mm) working length, 1.5mm tip with 12' cord, 10/per



### Hardy Disposable Bayonet Bipolar Forcep (non-insulated)

Catalog #	Description
286-109	8½" (215mm), smooth, 4½" (115mm) working length, 1.5mm tip with 12' cord, 10/per



### Hardy Disposable Bayonet Bipolar Forcep (insulated)

Catalog #	Description
286-110	8½" (215mm), smooth, 4½" (115mm) working length, 0.5mm tip with 12' cord, 10/per



### Hardy Disposable Bayonet Bipolar Forcep (non-insulated)

Catalog #	Description
286-111	8½" (215mm), smooth, 4½" (115mm) working length, 0.5mm tip with 12' cord, 10/per



### Disposable 12' Bipolar Cord with Banana Pin Connector

Catalog #	Description
286-112	10/per



### Frazier Dura Hook

Catalog #	Description
285-200	4 <sup>7</sup> / <sub>8</sub> " (125mm), sharp



### Dura Hook

Catalog #	Description
285-202	6 <sup>1</sup> / <sub>2</sub> " (165mm), sharp

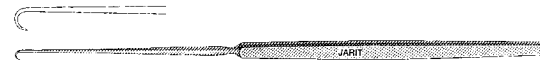

### Cushing Dura Hook

Catalog #	Description
285-205	5 <sup>5</sup> / <sub>8</sub> " (142mm), sharp



### Lahey Clinic Dura Hook

Catalog #	Description
285-210	5 <sup>1</sup> / <sub>4</sub> " (133mm), sharp



### Graham Dura Hook

Catalog #	Description
285-215	6 <sup>1</sup> / <sub>2</sub> " (166mm), blunt

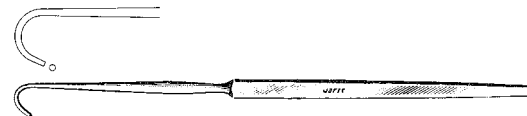

### Sachs Dura Hooks

Catalog #	Description
285-219	6" (154mm), sharp
285-220	8 <sup>1</sup> / <sub>2</sub> " (218mm), sharp
285-221	8 <sup>1</sup> / <sub>2</sub> " (218mm), blunt

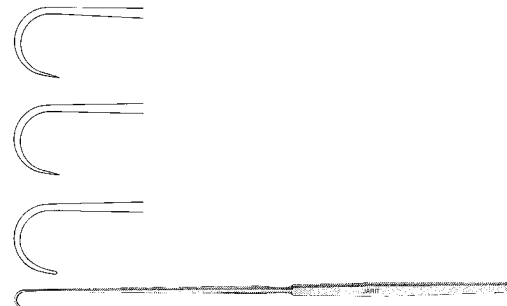

**Adson Dura Hook**

Catalog #	Description
285-225	7¾" (200mm), 6.5mm long, sharp tip

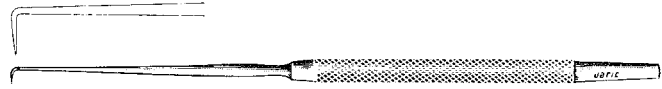

**Adson Dura Hook**

Catalog #	Description
285-227	8" (202mm), 7mm long, blunt tip

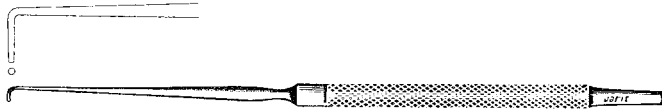

**Dandy Nerve Hook**

Catalog #	Description
285-230	9" (230mm), 5mm long, blunt tip



**Cushing Gasserian Ganglion Hook**

Catalog #	Description
285-233	9" (230mm), 6.1mm long, blunt tip

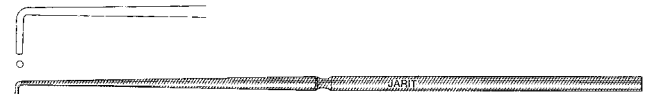

**Hoer Nerve Hooks**

blunt

Catalog #	Description
285-235	Straight, 9" (230mm), 7mm long tip
285-236	Angled, 8¾" (225mm), 7mm long tip

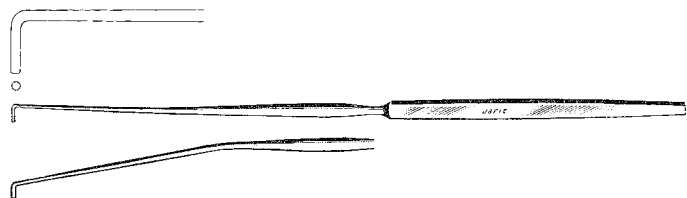

**Strully Dura Twist Hook**

Catalog #	Description
285-240	6¼" (157mm)





### Smithwick Sympathectomy Hook and Dissector

Catalog #	Description
285-315	12¼" (312mm)

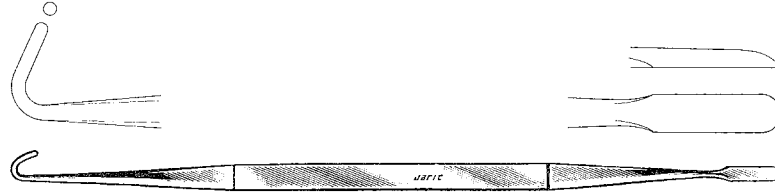

### Dissector (Neuro)

Catalog #	Description
285-318	8¾" (222mm), sharp end, blunt blades 6.5mm wide

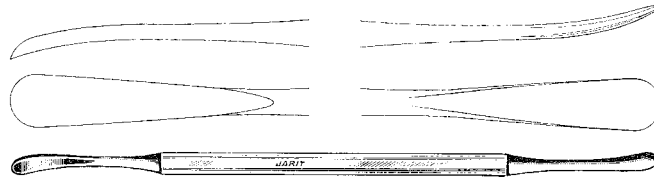

### Frazier Dura Separator

Catalog #	Description
285-320	6½" (165mm), 3.2mm wide x 10.5mm length blade



### Horsley Dura Separator

Catalog #	Description
285-325	7" (180mm), 7mm wide x 57mm length blade

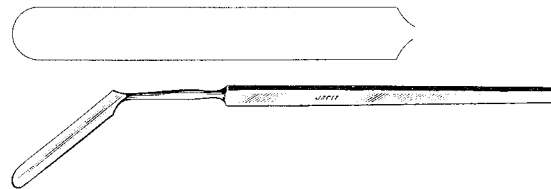

### Dorsey Dura Separator

Catalog #	Description
285-327	6" (153mm), grooved blade, 4.75mm wide x 20mm length blade

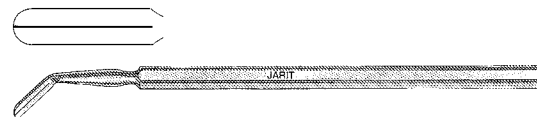

### Hoen Dura Separator

6¼" (156mm)

Catalog #	Description
285-330	45° angle, 3.6mm wide x 10mm length blade
285-331	90° angle, 3.6mm wide x 10mm length blade



**Sachs Nerve Separator**

Catalog #	Description
285-340	7 <sup>3</sup> / <sub>4</sub> " (196mm), 2.4mm blade

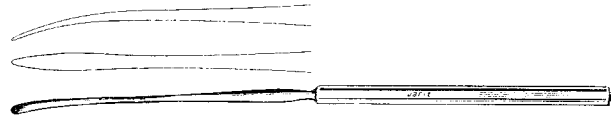

**Sachs Dural Separator**

Catalog #	Description
285-342	9" (230mm), 6mm wide x 84mm length blade

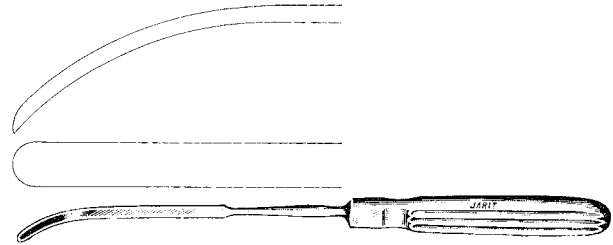

**Jarrit Periosteal Elevators**

6<sup>1</sup>/<sub>4</sub>" (160mm), curved blade

Catalog #	Description
285-345	Blunt
285-346	Semi-sharp



**Adson Periosteal Elevators**

6<sup>3</sup>/<sub>4</sub>" (170mm)

Catalog #	Description
285-350	Straight, chisel edge (9.3mm)
285-351	Curved, blunt (6.5mm)
285-352	Curved, semi-sharp (6.5mm)
285-353	Straight, semi-sharp (6.5mm)

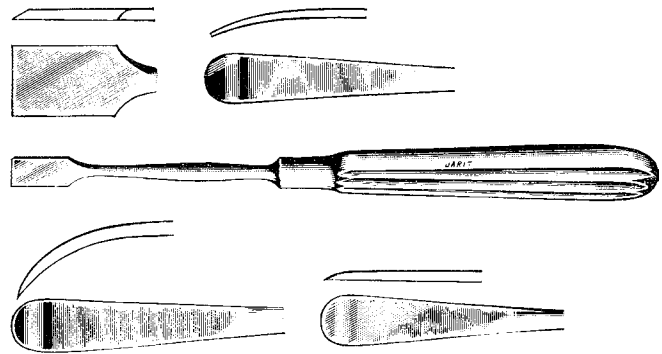

**Love-Adson Periosteal Elevator**

Catalog #	Description
285-355	6 <sup>1</sup> / <sub>2</sub> " (165mm), curved, semi-sharp (5mm)

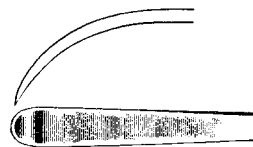

**Oldberg Dissector**

Catalog #	Description
285-357	7" (178mm), 5.6mm wide blade

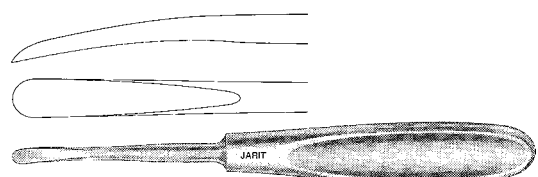

### Hoen Periosteal Elevators

Catalog #	Description
285-360	7¼" (183mm), 7mm wide blade
285-361	7½" (192mm), 15mm wide blade
285-362	7½" (192mm), 20mm wide blade



### Penfield Dissector

Catalog #	Description
285-365	No. 1: 7" (178mm), broad curved dissector, sharp round spoon

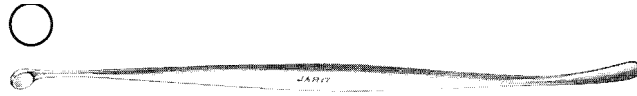

### Penfield Dissector

Catalog #	Description
285-366	No. 2: 7¼" (184mm), slightly curved dissector, wax packer



### Penfield Dissector

Catalog #	Description
285-367	No. 3: 7¼" (184mm), full curved dissector, wax packer

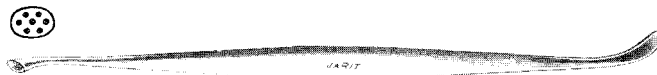

### Penfield Dissector

Catalog #	Description
285-368	No. 4: 8" (205mm), slightly curved dissector, light



### Penfield Dissector

Catalog #	Description
285-369	No. 5: 11¼" (287mm), slightly curved dissector, double ended, blunt

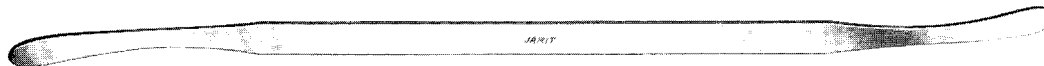

**Alderdyce Elevator and Dissector**

8½" (216mm)

Catalog #	Description
285-370	6.5mm and 8.5mm widths

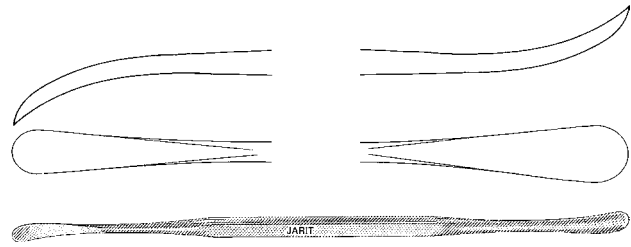

**Cushing Wide Sharp Elevators**

7½" (190mm), 15.5mm wide

Catalog #	Description
285-375	Convex edge
285-376	Square edge

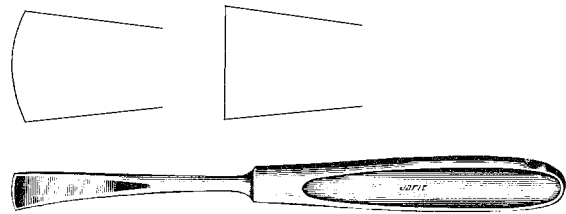

**Freer Double-ended Elevators**

7¾" (198mm), sharp-blunt blades

Catalog #	Description
285-379	6.5mm wide blades
285-380	5mm wide blades

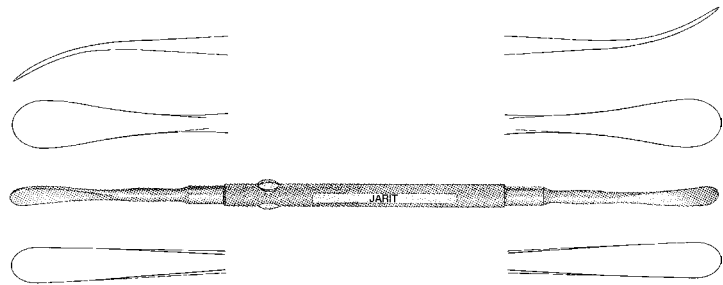

**Presbyterian Hospital Double-ended Elevators**

7¼" (184mm)

Catalog #	Description
285-381	Straight, 3.5mm and 4.5mm wide blades, blunt
285-382	Curved, 3.3mm and 4.1mm wide blades, blunt

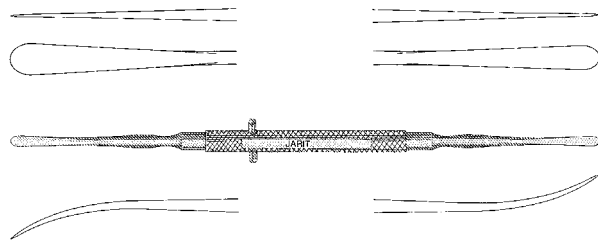

**Crile Ganglion Knife and Dissector**

8 1/2" (215mm)

Catalog #	Description
285-383	3.3mm knife and 3.3mm dissector, width

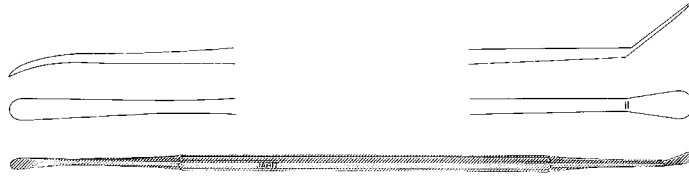

**Cushing Periosteal Elevator**

7 5/8" (195mm)

Catalog #	Description
285-384	5mm wide blade, sharp

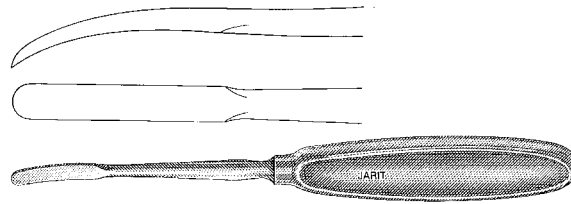

**Cushing Staphylorrhaphy Elevators**

Catalog #	Description
285-385	8 1/8" (205mm), grooved handle, 6.5mm wide blade

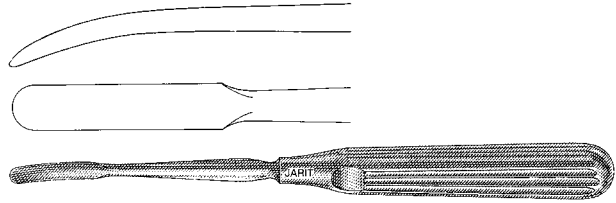

285-386	7 1/2" (190mm), Gutsch handle, 6.5mm wide blade
---------	---

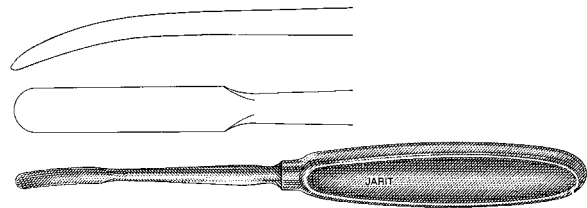

**Cushing "Little Joker" Periosteal Elevators**

Catalog #	Description
285-388	6" (152mm), hollow handle, 7mm wide blade

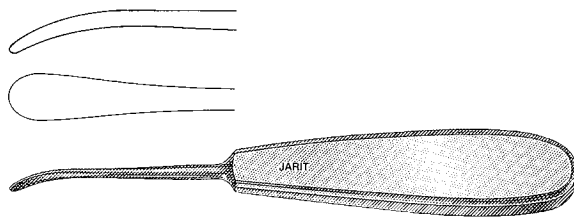

285-389	7 1/2" (190mm), solid handle, 6.5mm wide blade
---------	--

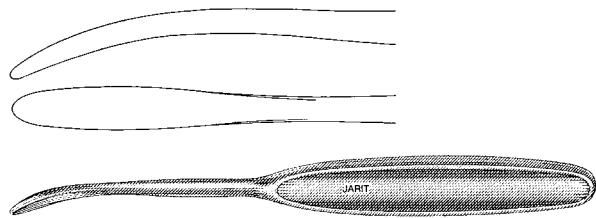

**Woodson Elevator and Spatula**  
10" (254mm)

Catalog #	Description
285-390	2.75mm x 3.3mm wide blades



**Woodson Dura Separator and Packer**

7" (178mm)

Catalog #	Description
285-391	3mm x 3.32mm wide blades

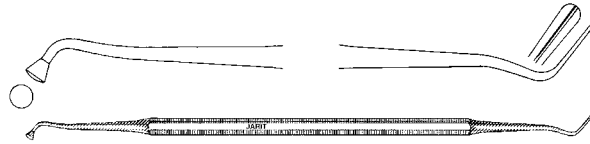

**Cloward Style Periosteal Elevators**

7¾" (198mm), Gutsch handle

Catalog #	Description
285-394	5mm wide blade, sharp
285-395	6.4mm wide blade, sharp
285-396	8mm wide blade, sharp

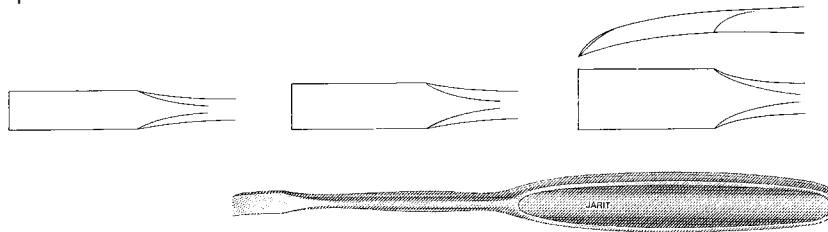

**Cloward Style Periosteal Elevator**

8" (203mm)

Catalog #	Description
285-397	6mm wide x 10mm long wide blade, sharp

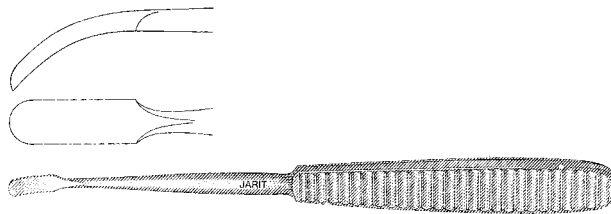

**Cushing Periosteal Elevator**

Catalog #	Description
285-398	8" (205mm), 6mm wide x 30mm length blade, sharp

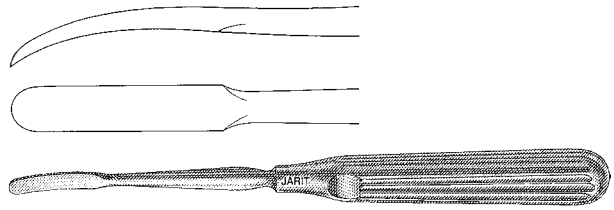

**Cushing Decompression Retractor**

Catalog #	Description
285-405	8 3/4" (220mm), 12mm wide blade

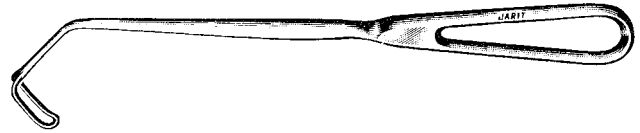

**Sachs Vein Retractors**

8 3/4" (220mm), angled

Catalog #	Description
285-411	8 3/4" (220mm), smooth, 12mm wide blade
285-412	8 1/2" (215mm), toothed, 16mm wide blade

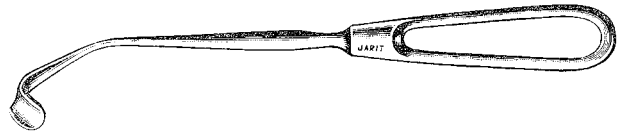

**Love Nerve Root Retractor**

Catalog #	Description
285-420	7 3/4" (195mm), straight, 7mm wide blade



**Love Nerve Root Retractor**

Catalog #	Description
285-421	6 1/2" (167mm), 45° angle, 7mm wide blade

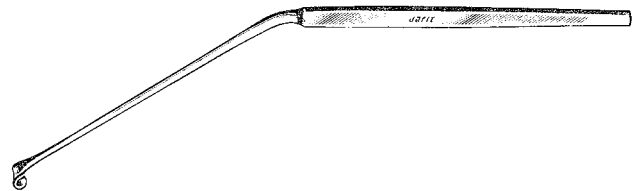

**Love Nerve Root Retractor**

Catalog #	Description
285-422	3 7/8" (98mm), 90° angle, 7mm wide blade

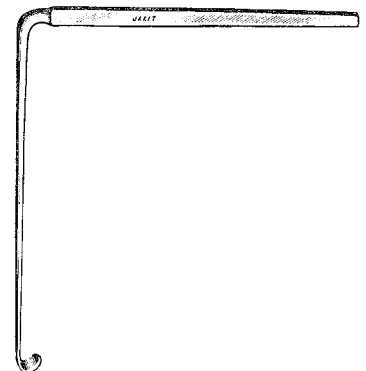



### D'Errico Nerve Root Retractor

Catalog #	Description
285-425	8¾" (220mm), 7.2mm wide blade

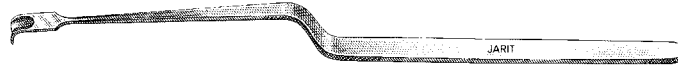

### Scoville Nerve Root Retractor

Catalog #	Description
285-430	9¼" (235mm), straight, 7.8mm wide blade



### Scoville Nerve Root Retractor

Catalog #	Description
285-431	7" (178mm), angular, 8mm wide blade

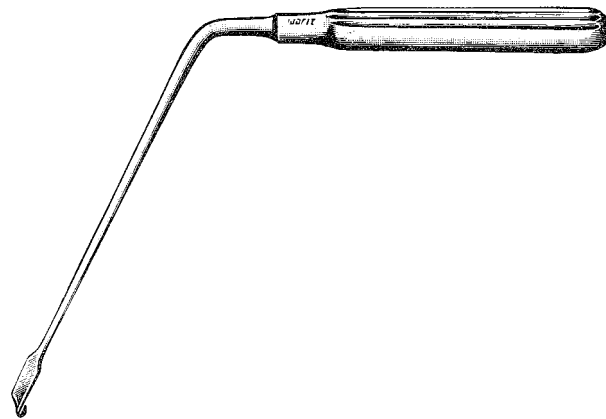

### Holscher Nerve Root Retractor

Catalog #	Description
285-433	9¾" (245mm), 6.5mm wide blade

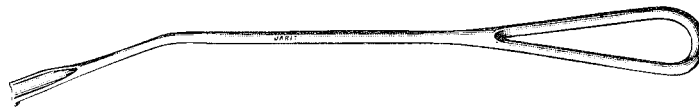

### Holscher Nerve Root Retractor

Catalog #	Description
285-434	9¾" (245mm), 13mm wide blade



### Campbell Nerve Root Retractor

Catalog #	Description
285-435	8¾" (224mm), 10.5mm wide blade

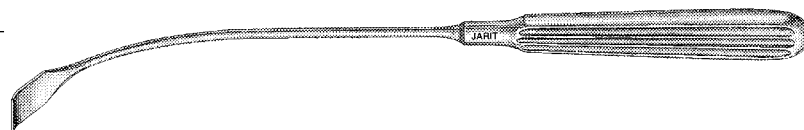

**Frazier Suction Tubes**

7½" (193mm), angular,  
working length 4" (102mm)

Catalog #	Description
285-449	5 French
285-450	6 French
285-451	7 French
285-452	8 French
285-453	9 French
285-454	10 French
285-455	11 French
285-456	12 French
285-457	14 French
285-458	15 French

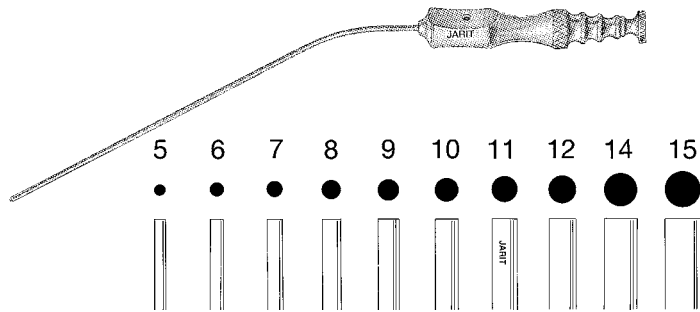

\*For stylets (angled Frazier Suction Tube only)  
add the letter "S" to catalog number.

**Frazier Suction Tubes**

7½" (192mm), straight,  
working length 5¼" (133mm)

Catalog #	Description
285-460	6 French
285-461	7 French
285-462	8 French
285-463	9 French
285-464	10 French
285-465	11 French
285-466	12 French

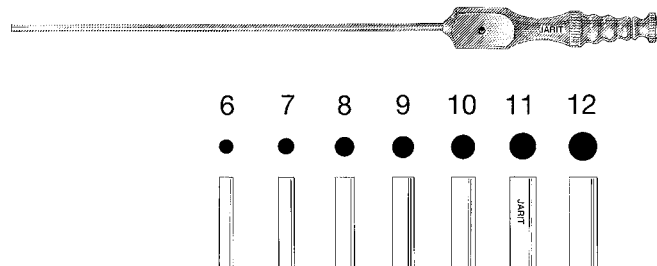

**Frazier Suction Tubes**

9" (231mm), straight,  
working length 6¾" (171mm)

Catalog #	Description
285-470	6 French
285-471	7 French
285-472	8 French
285-473	9 French
285-474	10 French
285-475	11 French
285-476	12 French

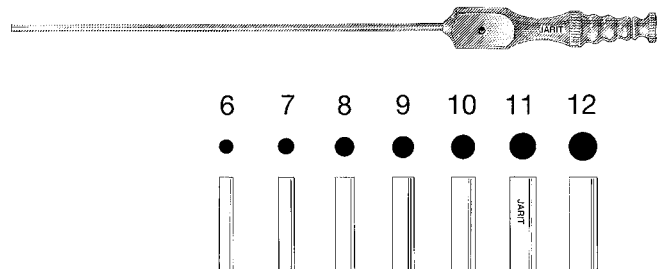

**Frazier Suction Tubes**

7½" (190mm), angular,  
working length 6½" (165mm)

Catalog #	Description
285-477	7 French
285-478	9 French
285-479	11 French

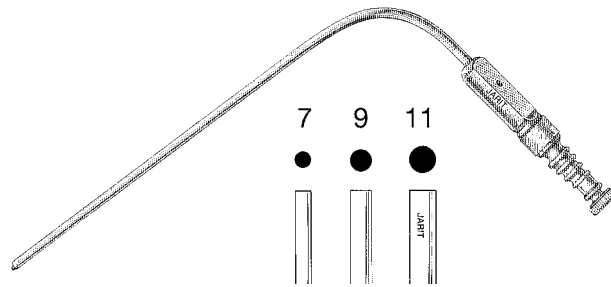

\*For stylets (angled Frazier Suction Tube only)  
add the letter "S" to catalog number.

**Baron Suction Tubes**

6½" (165mm), angular,  
working length 4" (100mm)

Catalog #	Description
285-480	3 French
285-482	5 French
285-484	7 French

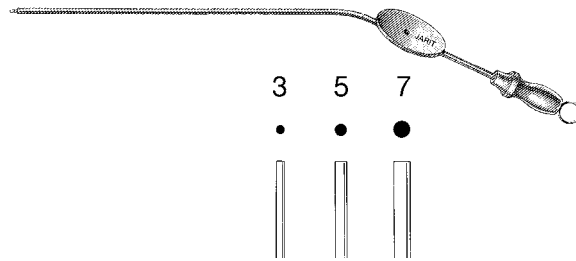

285-STY-480 Replacement Stylet

**Adson Suction Tubes**

12 French

Catalog #	Description
285-490	5⅛" (130mm)
285-492	7¾" (200mm)

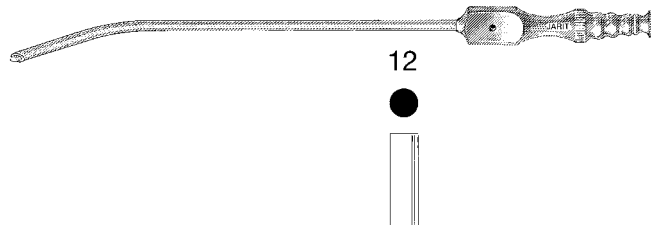

**Adson Cannula, Open End**

9 French, graduated in CM

Catalog #	Description
285-495	3⅞" (100mm) working length
285-496	5½" (140mm) working length



**Elsberg Cannula, 3-Hole Closed End**

4⅜" (110mm) working length, luer lock

Catalog #	Description
285-497	5 French
285-498	7 French
285-499	9 French



### Children's Hospital Spatula

Catalog #	Description
285-530	8½" (218mm), 14mm wide blade

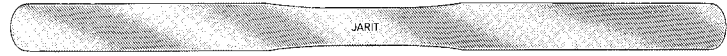

### Mayfield Spatula

Catalog #	Description
285-531	8" (205mm), 22mm wide blade

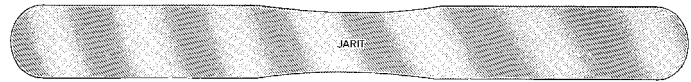

### Scoville Spatulas

8" (204mm), double-ended

Catalog #	Description
285-533	Small: 10 and 13mm wide blades
285-534	Large: 16 and 19mm wide blades



### Davis Spatulas

7" (178mm), malleable, German silver

Catalog #	Description
285-540	¼" (6mm) wide
285-541	⅜" (9mm) wide
285-542	½" (13mm) wide
285-543	⅝" (16mm) wide
285-544	¾" (19mm) wide
285-545	1" (25mm) wide
285-546	1¼" (32mm) wide
285-547	1½" (38mm) wide



### Cushing Spatulas

double-ended

Catalog #	Description
285-550	6½" (168mm), 13mm and 19mm wide blades
285-551	7¾" (197mm), 19 and 25mm wide blades



**Jansen Retractors**

3" (76mm)

Catalog #	Description
290-100	3 x 3 sharp prongs, 13mm deep
290-101	3 x 3 blunt prongs, 13mm deep

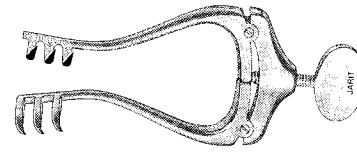

**Jansen Retractor**

3¾" (94mm)

Catalog #	Description
290-102	4 x 4 blunt prongs, 22mm deep

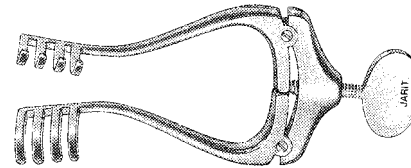

**Scalp Retractor**

5¼" (133mm), curved arms to fit contour of skull

Catalog #	Description
290-120	3 x 4 blunt prongs, 17.5mm deep

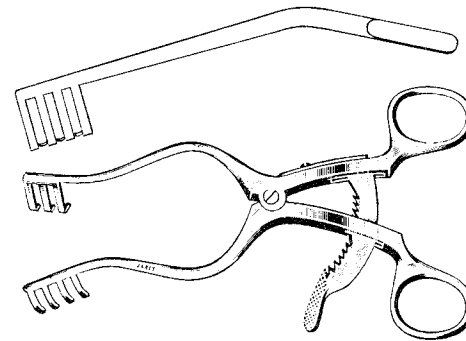

**Anderson-Adson Scalp Retractor**

7¾" (197mm), angled arms

Catalog #	Description
290-122	4 x 4 sharp prongs, 16mm deep

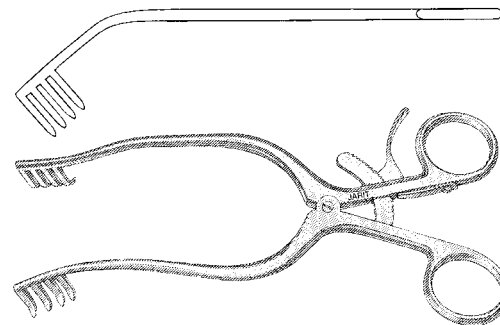

**Miskimon Cerebellar Retractor**

7¾" (198mm), angled arms

Catalog #	Description
290-125	7 x 7 sharp prongs, 34mm deep

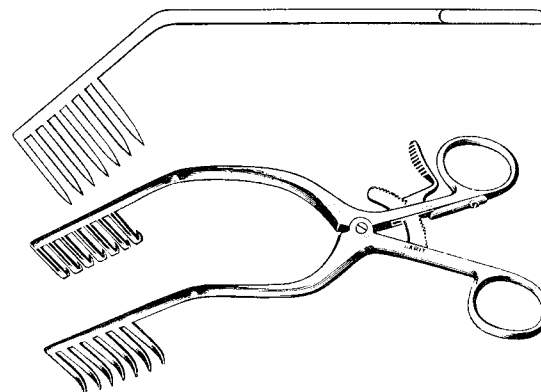

### Weitlaner Retractor, (Satin Finish)

Manufactured from high grade German surgical stainless steel which is ground and polished to a satin finish

Catalog #	Description
205-140	4 <sup>3</sup> / <sub>8</sub> " (110mm), 2 x 3 sharp prongs, 15mm deep
205-141	4 <sup>3</sup> / <sub>8</sub> " (110mm), 2 x 3 blunt prongs, 15mm deep
205-150	5 <sup>3</sup> / <sub>8</sub> " (135mm), 3 x 4 sharp prongs, 17mm deep
205-151	5 <sup>3</sup> / <sub>8</sub> " (135mm), 3 x 4 blunt prongs, 17mm deep
205-155	6 <sup>1</sup> / <sub>2</sub> " (165mm), 3 x 4 sharp prongs, 18mm deep
205-156	6 <sup>1</sup> / <sub>2</sub> " (165mm), 3 x 4 blunt prongs, 18mm deep
205-160	7 <sup>3</sup> / <sub>4</sub> " (195mm), 3 x 4 sharp prongs, 20mm deep
205-161	7 <sup>3</sup> / <sub>4</sub> " (195mm), 3 x 4 blunt prongs, 20mm deep
205-165	9 <sup>1</sup> / <sub>2</sub> " (240mm), 3 x 4 sharp prongs, 27mm deep
205-166	9 <sup>1</sup> / <sub>2</sub> " (240mm), 3 x 4 blunt prongs, 27mm deep

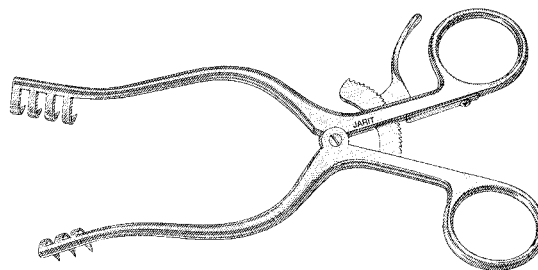

### Weitlaner Retractor, (Matte Finish)

Manufactured from high grade German surgical stainless steel which is glass beaded to a matte finish

Catalog #	Description
204-140	4 <sup>3</sup> / <sub>8</sub> " (110mm), 2 x 3 sharp prongs, 15mm deep
204-141	4 <sup>3</sup> / <sub>8</sub> " (110mm), 2 x 3 blunt prongs, 15mm deep
204-150	5 <sup>3</sup> / <sub>8</sub> " (135mm), 3 x 4 sharp prongs, 17mm deep
204-151	5 <sup>3</sup> / <sub>8</sub> " (135mm), 3 x 4 blunt prongs, 17mm deep
204-155	6 <sup>1</sup> / <sub>2</sub> " (165mm), 3 x 4 sharp prongs, 18mm deep
204-156	6 <sup>1</sup> / <sub>2</sub> " (165mm), 3 x 4 blunt prongs, 18mm deep
204-160	7 <sup>3</sup> / <sub>4</sub> " (195mm), 3 x 4 sharp prongs, 20mm deep
204-161	7 <sup>3</sup> / <sub>4</sub> " (195mm), 3 x 4 blunt prongs, 20mm deep
204-165	9 <sup>1</sup> / <sub>2</sub> " (240mm), 3 x 4 sharp prongs, 27mm deep
204-166	9 <sup>1</sup> / <sub>2</sub> " (240mm), 3 x 4 blunt prongs, 27mm deep

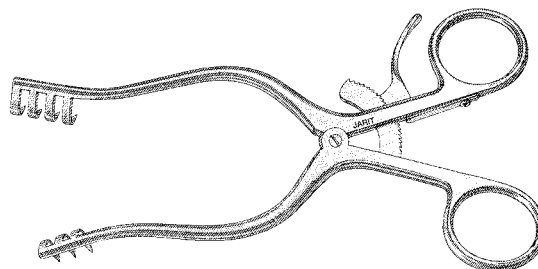

### Weitlaner Retractor Replacement Parts

Catalog #	Description
205-SPS-140	Replacement Spring and Screw
205-SPS-141	Replacement Spring and Screw
205-SPS-150	Replacement Spring and Screw
205-SPS-151	Replacement Spring and Screw
205-SPS-155	Replacement Spring and Screw
205-SPS-156	Replacement Spring and Screw
205-SPS-160	Replacement Spring and Screw
205-SPS-161	Replacement Spring and Screw

## Weitlaner Retractors

hinged blades

Catalog #	Description
205-175	5½" (140mm), 3 x 4 sharp prongs, 18mm deep
205-176	5½" (140mm), 3 x 4 blunt prongs, 18mm deep
205-180	6½" (162mm), 3 x 4 sharp prongs, 18mm deep
205-181	6½" (162mm), 3 x 4 blunt prongs, 18mm deep
205-190	8¼" (210mm), 3 x 4 sharp prongs, 20mm deep

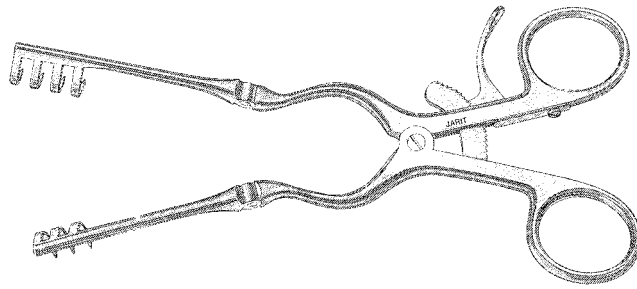

## Adson Cerebellar Retractors

7¾" (140mm), straight

Catalog #	Description
205-200	4 x 4 sharp prongs, 22mm deep
205-201	4 x 4 blunt prongs, 22mm deep

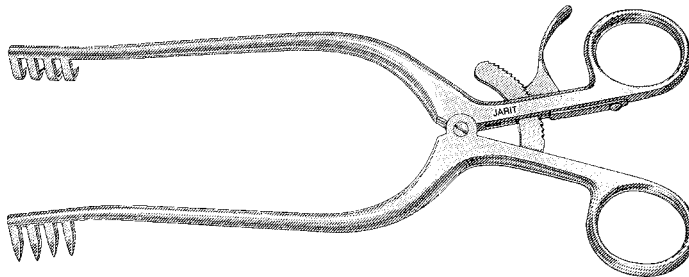

## Adson Cerebellar Retractors

7½" (188mm), angled

Catalog #	Description
205-205	4 x 4 sharp prongs, 22mm deep
205-206	4 x 4 blunt prongs, 22mm deep

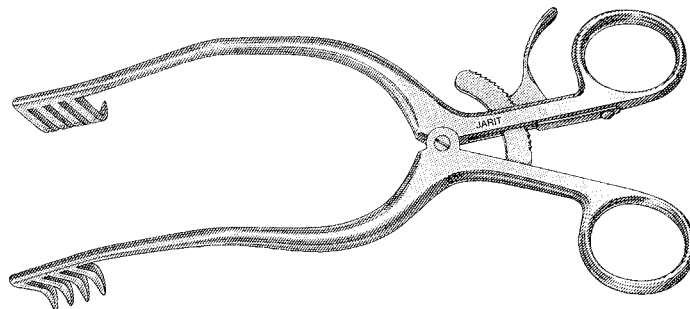

**Beckman Thyroid Retractor**

Catalog #	Description
205-209	9 1/2" (240mm), 3 x 4 sharp prongs, 1 1/8" deep (28mm)
205-210	12 3/8" (316mm), 4 x 4 sharp prongs, 1" deep (24mm)

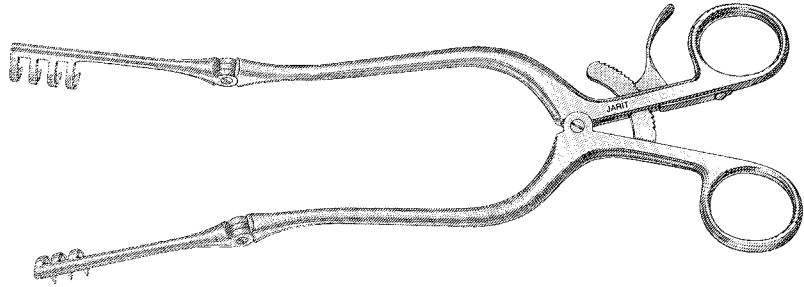

**Beckman-Adson Laminectomy Retractors**

12 1/4" (309mm)

Catalog #	Description
205-220	4 x 4 sharp prongs, 1 1/8" x 1 1/8" (28mm x 29.5mm)
205-221	4 x 4 blunt prongs, 1 1/8" x 1 1/8" (28mm x 29.5mm)
205-225	4 x 4 sharp prongs, 1 1/8" x 1 7/8" (28mm x 48mm)
205-226	4 x 4 blunt prongs, 1 1/8" x 1 7/8" (28mm x 48mm)

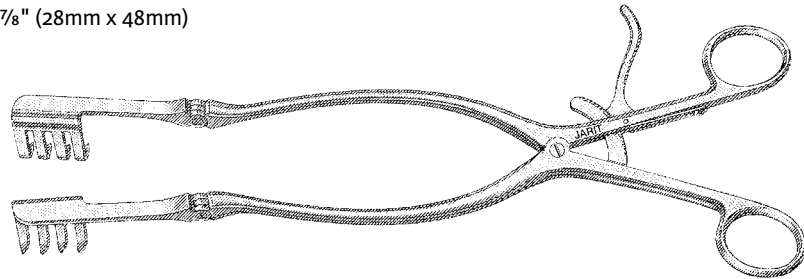

**Beckman-Eaton Laminectomy Retractor**

12 3/4" (324mm)

Catalog #	Description
205-230	7 x 7 sharp prongs, 1 5/8" x 2" (42mm x 50mm)

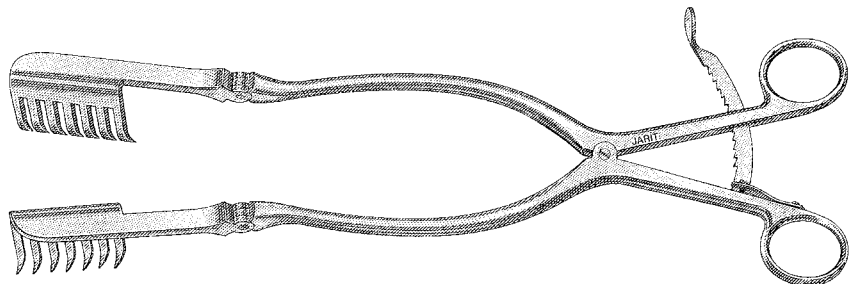



### Meyerding Laminectomy Retractors

7<sup>3</sup>/<sub>4</sub>" (194mm)

Catalog #	Description
205-240	Blades 1" x 1 <sup>1</sup> / <sub>4</sub> " deep (25mm x 31mm)
205-242	Blades 1" x 2 <sup>1</sup> / <sub>8</sub> " deep (25mm x 54mm)
205-244	Blades 3 <sup>3</sup> / <sub>4</sub> " x 2 <sup>3</sup> / <sub>8</sub> " deep (19mm x 63mm)
205-245	Blades 1" x 2 <sup>3</sup> / <sub>8</sub> " deep (25mm x 60mm)

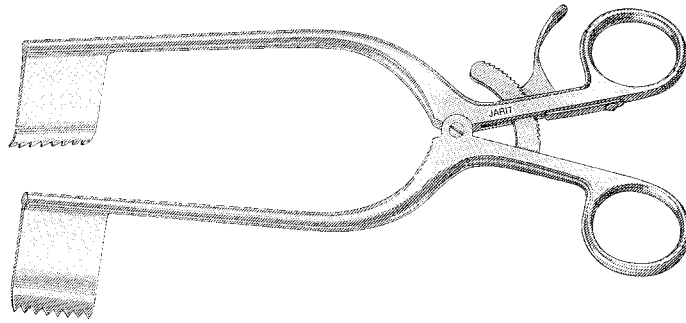

### Markham-Meyerding Hemilaminectomy Retractor

6<sup>3</sup>/<sub>4</sub>" (170mm), blade on right side

Catalog #	Description
205-255	Blades 1" x 2 <sup>1</sup> / <sub>8</sub> " deep (25mm x 63mm)

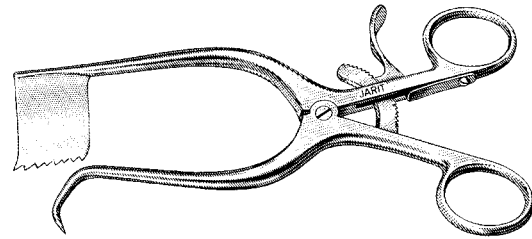

### Markham-Meyerding Hemilaminectomy Retractor

6<sup>3</sup>/<sub>4</sub>" (170mm), blade on left side

Catalog #	Description
205-256	Blades 1" x 2 <sup>1</sup> / <sub>2</sub> " deep (25mm x 66mm)

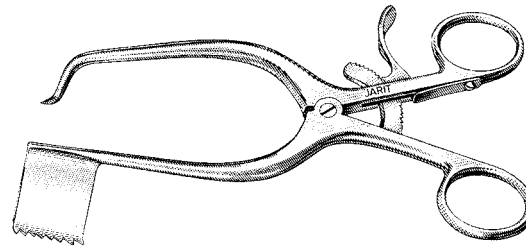

### Lamina Spreader

Catalog #	Description
290-145	11" (277mm), concave blades, 16mm wide

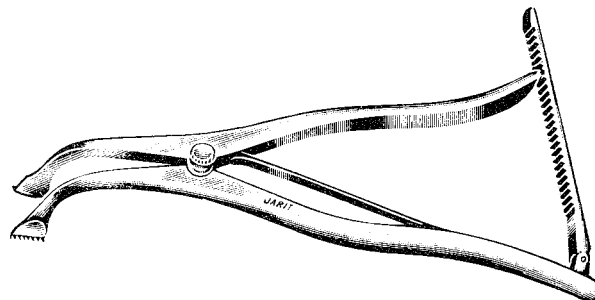

**Inge Lamina Spreader**  
with teeth

Catalog #	Description
290-150	10¼" (260mm), adult size, 11mm wide blades
290-152	6½" (165mm), child size, 7.2mm wide blades
290-THS-152	Replacement Thumb Screw
290-SPS-152	Replacement Spring and Screws

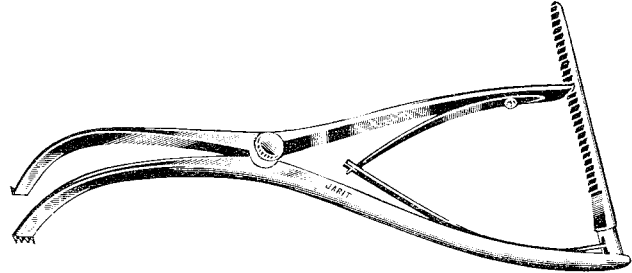

**Inge Lamina Spreader**  
without teeth

Catalog #	Description
290-153	6½" (164mm), child size, 7.3mm wide blades

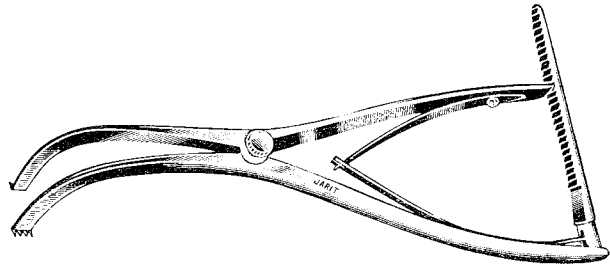

**Cloward Style Cervical Spreader**  
with teeth

Catalog #	Description
290-166	6¼" (156mm), improved model

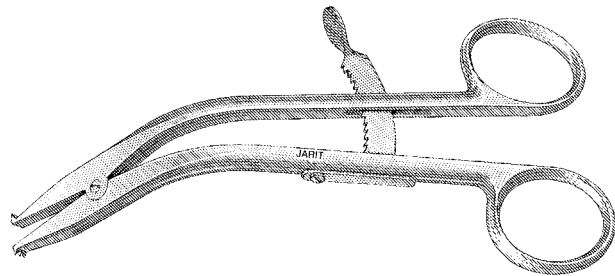

**Cloward Style Blade Retractor**  
¾" (83mm) long blades

Catalog #	Description
290-175	7¾" (188mm), 18mm wide
290-176	7¾" (188mm), 20mm wide
290-177	7¾" (188mm), 23mm wide

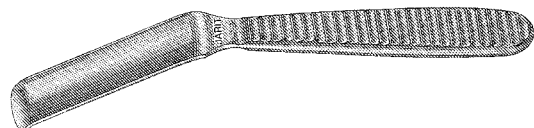

### Taylor Spinal Retractors

7¼" (184mm)

Catalog #	Description
290-180	1¼" x 3" blade (32mm x 76mm)
290-181	1¼" x 4" blade (32mm x 103mm)

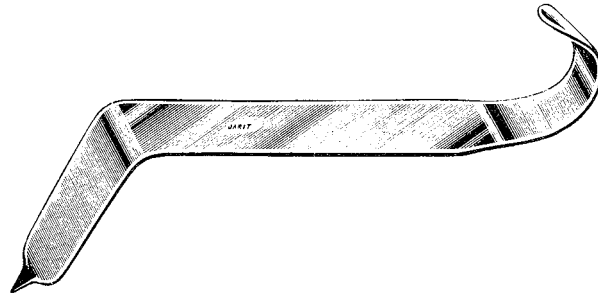

### Hoehn Hemilaminectomy Retractor

10" (254mm)

Catalog #	Description
290-190	Sets consist of 1 ea. retractor body 1 pair small blades, left and right 1 pair large blades, left and right
290-SBL-190LL	Replacement Small Blade Left
290-SBL-190LR	Replacement Small Blade Right
290-BLD-190	Replacement Set of 4 Blades
290-SBL-190	Replacement Small Blades
290-LBL-190LL	Replacement Large Blade Left
290-LBL-190LR	Replacement Large Blade Right
290-LBL-190	Replacement Large Blades

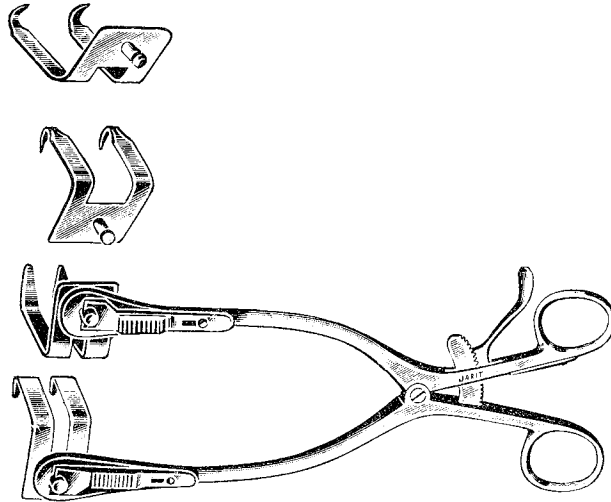

### Seletz-Gelpi Laminectomy Retractor

Catalog #	Description
290-200	6½" (165mm), arm length 2¼" (57mm) from bend

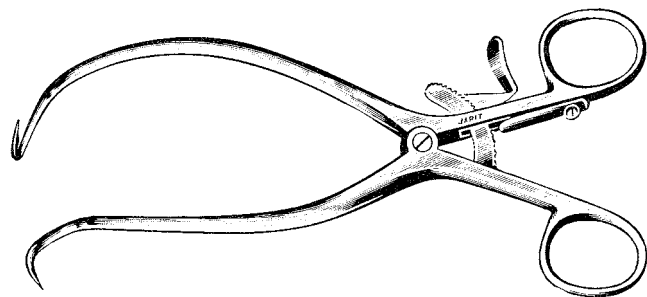

### Scoville Hemilaminectomy Retractor Frame

Catalog #	Description
290-210	Overall opening: 7½" (190mm) Spread: 5¾" (145mm) Arm length: 5½" (140mm)
290-TSG-210	Thumbscrew and Gear

### Haverfield-Scoville Hemilaminectomy Retractor Frame

Catalog #	Description
290-220	Overall opening: 7½" (190mm) Spread: 5¾" (145mm) Arm length: 5¾" (146mm)
290-TSG-210	Thumbscrew and Gear

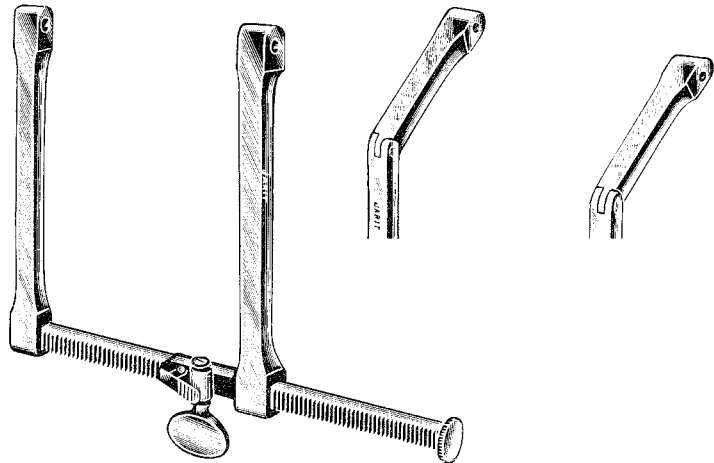

### Scoville Blades

hook style

Catalog #	Description
290-211	2" deep (51mm)
290-212	3" deep (76mm)
290-213	2" deep (51mm), with cross bar
290-214	2¾" deep (70mm), with cross bar
290-KNS-212	Replacement Knurled Sleeve

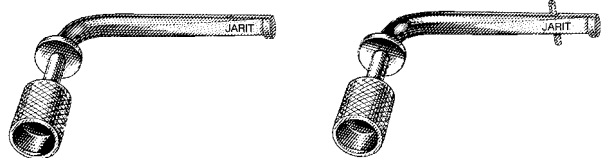

## Scoville Blades

solid

Catalog #	Description
290-215	1" wide x 2 1/2" deep (25mm x 64mm)
290-216	2" wide x 2 1/2" deep (51mm x 64mm)
290-217	1 1/4" wide x 2 5/8" deep (32mm x 67mm)
290-218	1" wide x 3 1/2" deep (25mm x 89mm)

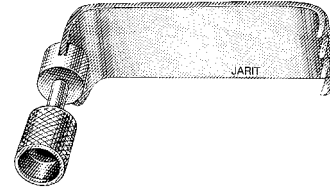

## Scoville Blades

4 prongs

Catalog #	Description
290-221	1 1/2" wide x 1 5/8" deep (38mm x 41mm)
290-222	1 7/8" wide x 2 5/8" deep (48mm x 67mm)

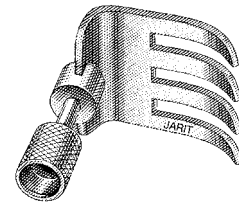

## Meyerding Blades

Catalog #	Description
290-225	1" wide x 2 1/4" deep (25mm x 57mm)
290-226	1" wide x 3" deep (25mm x 76mm)
290-227	2" wide x 3 1/2" deep (51mm x 89mm)

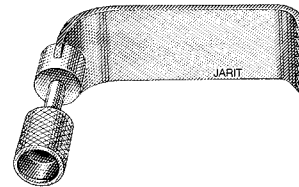

## Hibbs Blades

Catalog #	Description
290-230	1" wide x 2" deep (25mm x 51mm)
290-231	2" wide x 2" deep (51mm x 51mm)
290-232	1" wide x 2 1/2" deep (25mm x 64mm)
290-233	1 1/2" wide x 2 1/2" deep (38mm x 64mm)
290-234	1" wide x 3" deep (25mm x 76mm)
290-235	1 1/2" wide x 3" deep (38mm x 76mm)
290-236	2" wide x 3" deep (51mm x 76mm)
290-237	1" wide x 4" deep (25mm x 102mm)
290-238	2" wide x 4" deep (51mm x 102mm)

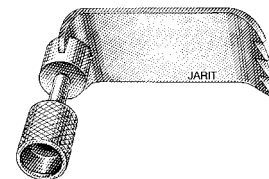

### Taylor Spinal Blades

Catalog #	Description
290-240	1 1/4" wide x 3" deep (32mm x 76mm)
290-241	1 1/4" wide x 4" deep (32mm x 102mm)

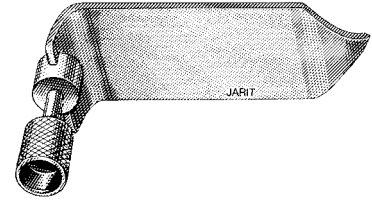

### Taylor Laminectomy Blade

3 prongs

Catalog #	Description
290-242	1 1/2" wide x 1 3/4" deep (38mm x 44mm)

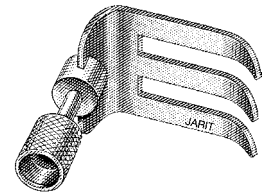

### Taylor Laminectomy Blades

4 prongs

Catalog #	Description
290-244	2" wide x 1 7/8" deep (51mm x 48mm)
290-245	2 1/2" wide x 2 1/2" deep (64mm x 64mm)
290-246	2 1/4" wide x 3 1/8" deep (57mm x 79mm)

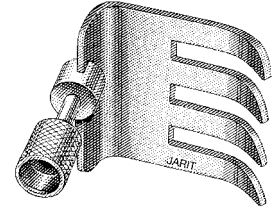

### Badgley Laminectomy Retractor

Catalog #	Description
290-251	6 1/2" (165mm) spread Overall opening: 9" (230mm) Blades: 1 3/4" x 2 1/8" (44mm x 55mm) Arm length: 4 1/4" (110mm)

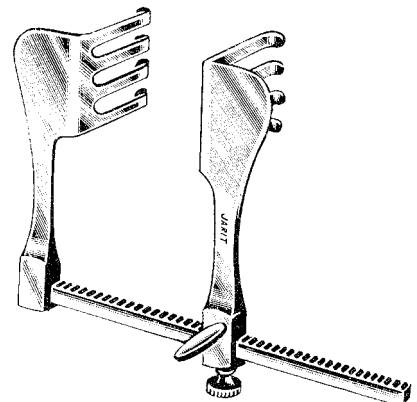

### Cloward Style Cervical Retractor Set

Catalog #	Description
290-260	Large, 10" (254mm) with 7 pairs of sharp blades

### Cloward Style Cervical Retractor Body

Catalog #	Description
290-261	Large, 10" (254mm)

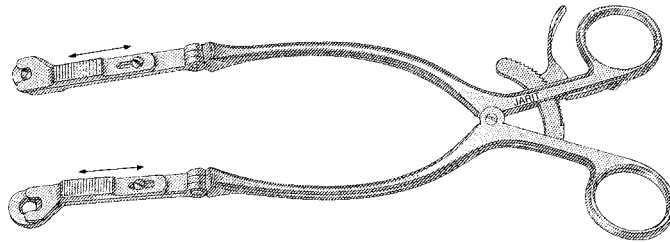

### Cloward Style Cervical Retractor Blades

4 sharp prongs, 15mm wide, individually sold

Catalog #	Description
290-262	25mm deep blade
290-263	30mm deep blade
290-264	35mm deep blade
290-265	40mm deep blade
290-266	45mm deep blade
290-267	50mm deep blade
290-268	55mm deep blade

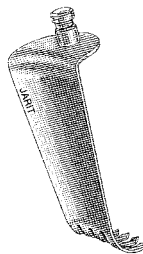

### Cloward Style Cervical Retractor Set

Catalog #	Description
290-280	Small, 6¾" (171mm) with 7 pairs of blunt blades

### Cloward Style Cervical Retractor Body

Catalog #	Description
290-281	Small, 6¾" (171mm)

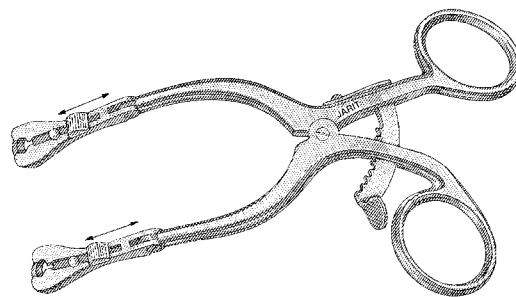

### Cloward Style Cervical Retractor Blades

blunt, 15mm wide, individually sold

Catalog #	Description
290-282	25mm deep blade
290-283	30mm deep blade
290-284	35mm deep blade
290-285	40mm deep blade
290-286	45mm deep blade
290-287	50mm deep blade
290-288	55mm deep blade

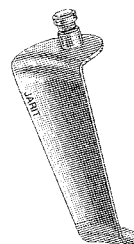

**Cloward Style Cervical Vertebra Spreader**

Catalog #	Description
290-300	Total length: 5" (127mm) Maximum opening: 5/8" (15mm) Arm length: 2 3/4" (70mm)

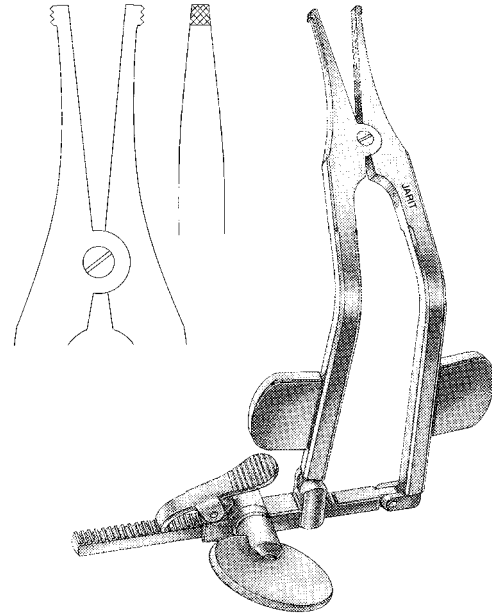

**Cloward Style Cervical Vertebra Spreader**

Catalog #	Description
290-305	2 3/4" (70mm) arm length, maximum opening 3" (79mm)

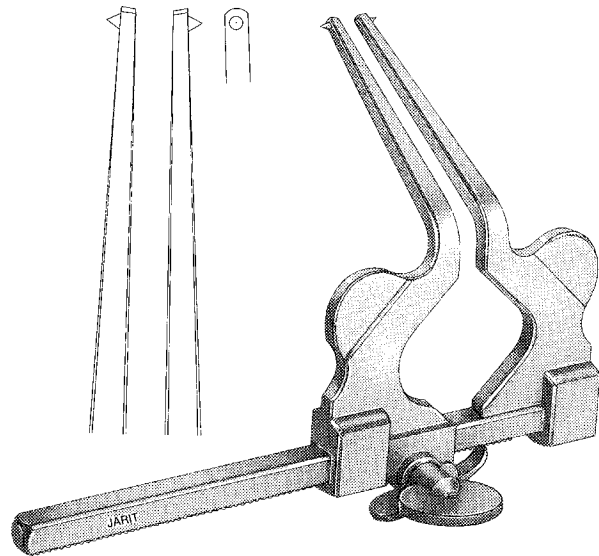



**Cloward Style Lumbar Lamina Spreader**

Catalog #	Description
290-310	Total length: 5½" (140mm) Maximum opening: 2½" (62mm) Total arm length: 3¾" (95mm)

**Cloward Style Lumbar Interbody Spreader**

Catalog #	Description
290-315	Total length: 5⅞" (150mm) Maximum opening: 2⅜" (60mm) Total arm length: 3⅞" (100mm)

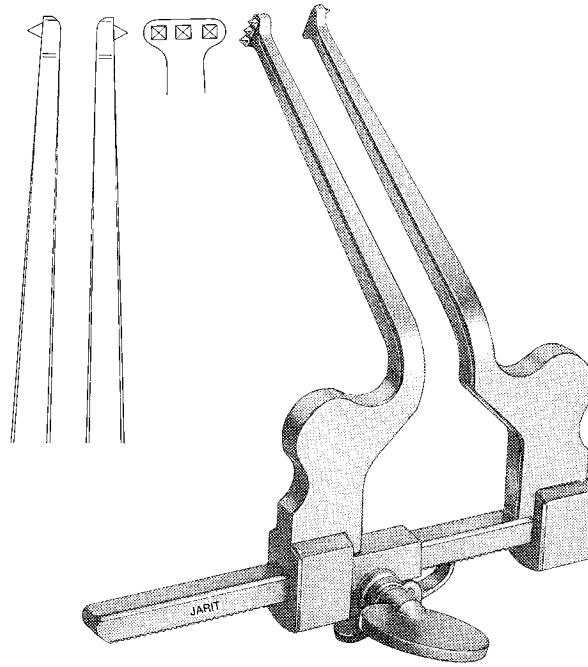

**Williams-Type Discectomy Retractors**  
narrow blade, 6¾" (170mm)

Catalog #	Description
290-320	50mm x 10mm, left
290-321	50mm x 10mm, right
290-322	60mm x 10mm, left
290-323	60mm x 10mm, right
290-324	70mm x 10mm, left
290-325	70mm x 10mm, right

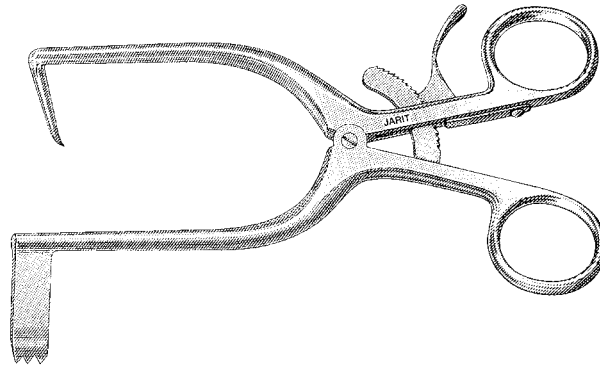

**Williams-Type Discectomy Retractors**  
wide blade, 6¾" (170mm)

Catalog #	Description
290-330	50mm x 20mm, left
290-331	50mm x 20mm, right
290-332	60mm x 20mm, left
290-333	60mm x 20mm, right
290-334	70mm x 20mm, left
290-335	70mm x 20mm, right

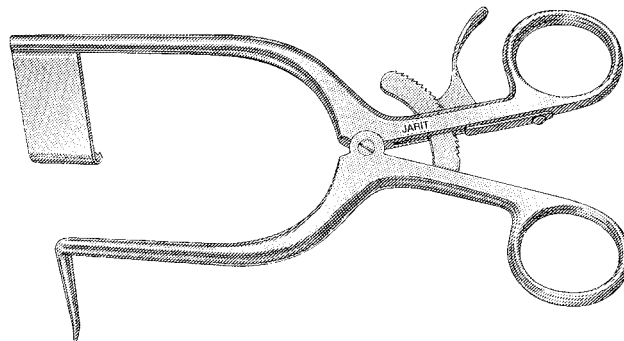

### Hudson Cranial Drill Set

Catalog #	Description
295-110	Hudson cranial drill set

Includes:

295-111	Hudson brace, 9½" (243mm), 9mm diameter
295-112	Hudson burr, 9mm diameter
295-113	Hudson burr, 14mm diameter
295-114	Hudson burr, 16mm diameter
295-115	Hudson burr, 22mm diameter
295-116	Hudson cerebellar extension

295-SRW-116 Replacement Set Screw

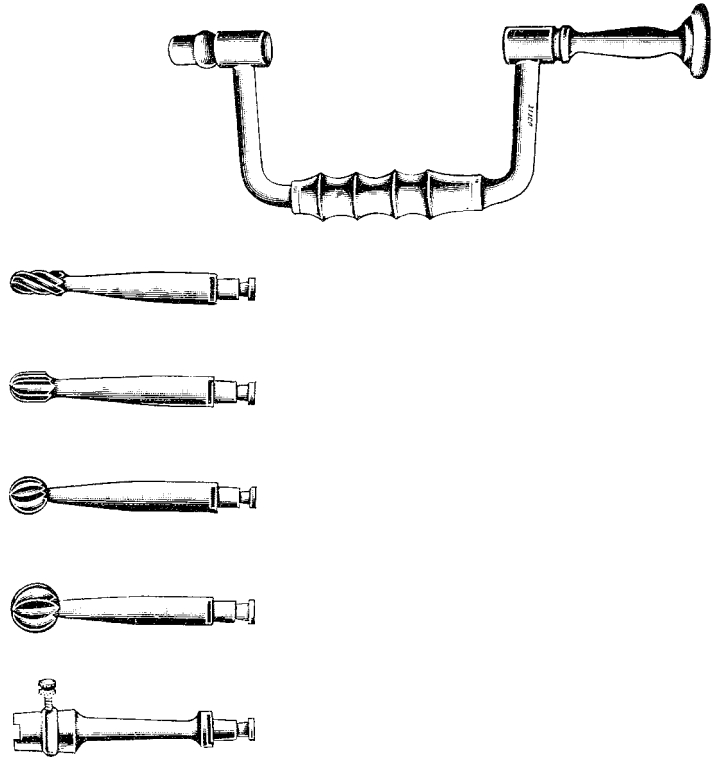

### Hudson Brace

improved model with precision snap lock

Catalog #	Description
295-117	9¾" (247mm)

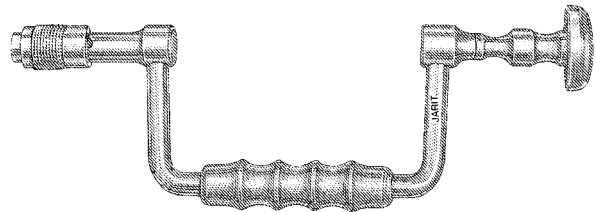

### Cushing Perforator Drills

3½" (90mm)

Catalog #	Description
295-130	10mm (¾") diameter
295-131	13mm (½") diameter
295-132	16mm (⅝") diameter

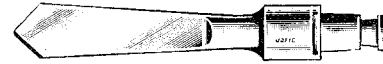

### McKenzie Perforator Drill

3⅞" (98mm)

Catalog #	Description
295-140	13mm (½") diameter



### D'Errico Perforator Drill

3¾" (96mm)

Catalog #	Description
295-145	16mm (⅝") diameter

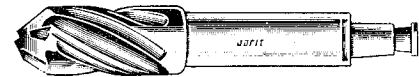

### McKenzie Enlarging Burr

3⅞" (98mm)

Catalog #	Description
295-150	20mm (¾") diameter



### Michele Trephine

6" (155mm) working length

Catalog #	Description
260-116	⅜" (5mm)
260-117	¼" (6mm)
260-118	⅝" (8mm)

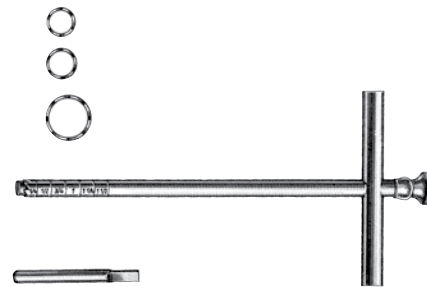

### Adson Drill Guide

Catalog #	Description
295-175	6" (155mm), angled on side

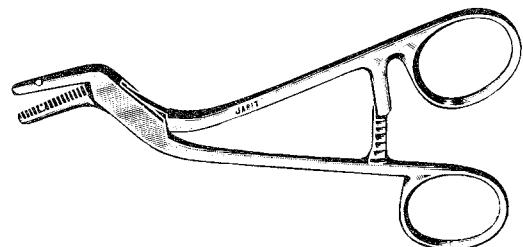

**Frazier (Schmeden) Dura Scissors**

Catalog #	Description
295-200	6 1/2" (165mm)

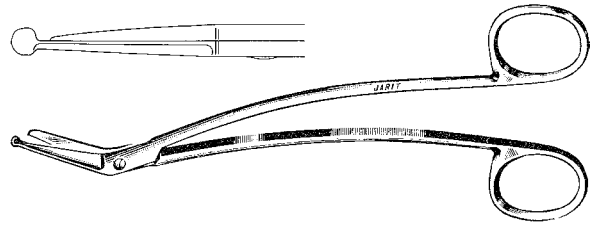

**Taylor Dura Scissors**

Catalog #	Description
295-205	5 1/2" (140mm), delicate

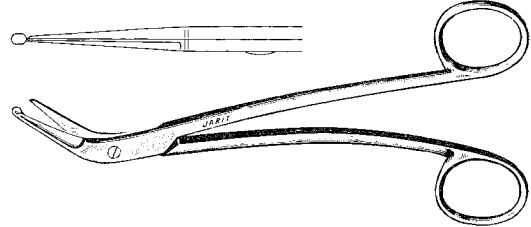

**Dandy Trigeminal Scissors**

Catalog #	Description
295-210	6 3/4" (172mm)
295-211	7 3/4" (197mm)

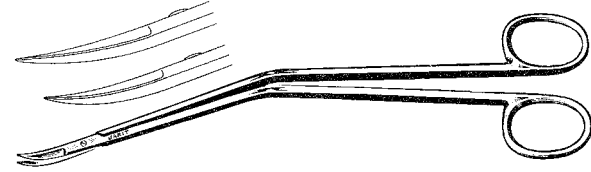

**Strully Scissors**

Catalog #	Description
295-215	7 3/4" (200mm)

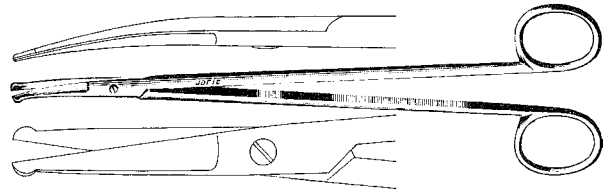

**Metzenbaum Scissors, Carb-Edge**

Catalog #	Description
101-261	7" (179mm), curved, delicate

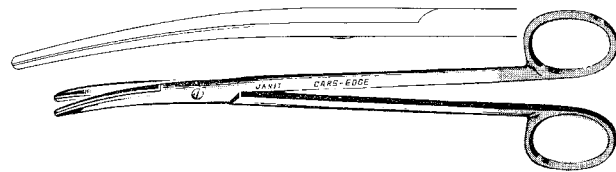

**Metzenbaum Scissors, Delicate, Supercut**

Catalog #	Description
102-310	7" (178mm), curved, delicate

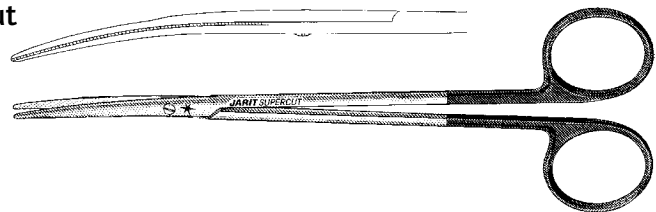

**Adson Ganglion Scissors**

6 1/4" (158mm)

Catalog #	Description
295-220	Straight
295-221	Curved

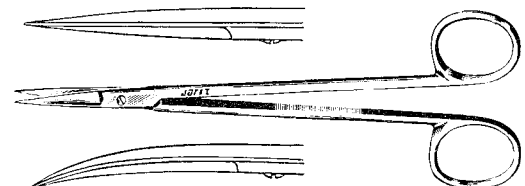



# **Integra™** Thoracic and Cardiovascular Instruments and General Surgical Instruments

**Integra™ Jarit® Cardiovascular Thoracic Instruments** have been designed to meet the needs of Cardiovascular, Peripheral Vascular and Thoracic surgeons worldwide.

### Davidson Scalpula Retractors

7<sup>3</sup>/<sub>4</sub>" (197mm)

Catalog #	Description
300-450	Small size, 3 <sup>1</sup> / <sub>4</sub> " x 2" (82mm x 51mm)
300-451	Large size, 3 <sup>1</sup> / <sub>4</sub> " x 3 <sup>1</sup> / <sub>2</sub> " (82mm x 89mm)

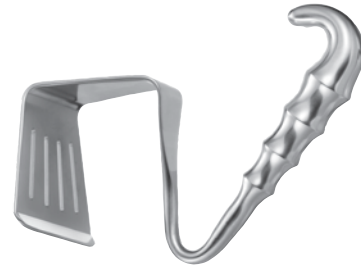

### Allison Lung Retractors

Catalog #	Description
310-420	Large size, 12 <sup>1</sup> / <sub>2</sub> " x 2 <sup>1</sup> / <sub>8</sub> " (315mm x 55mm)
310-424	Small size, 10" x 1 <sup>5</sup> / <sub>8</sub> " (255mm x 40mm)



### Cooley Atrial Valve Retractors

Catalog #	Description
310-150	Right, 7 <sup>3</sup> / <sub>4</sub> " (196mm), 25mm wide x 46mm deep
310-151	Right, 7 <sup>3</sup> / <sub>4</sub> " (196mm), 35mm wide x 45mm deep
310-152	Right, 7 <sup>3</sup> / <sub>4</sub> " (196mm), 50mm wide x 45mm deep
310-155	Left, 9" (230mm), 50mm wide x 20mm deep

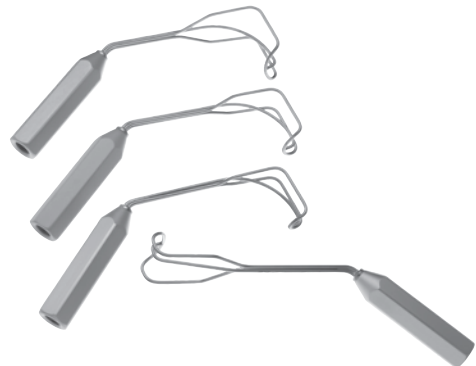

### Desmarres-Type Valve Retractors

7<sup>1</sup>/<sub>4</sub>" (185mm), malleable

Catalog #	Description
310-490	4mm wide
310-491	6mm wide
310-492	8mm wide
310-493	10mm wide
310-494	12mm wide
310-495	15mm wide

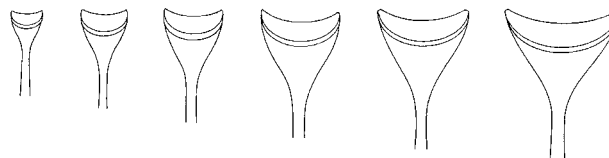

### Ross Aortic Valve Retractors

Catalog #	Description
310-140	No 1 blade: 9½" (241mm), blade ⅝" x ⅝" (15mm x 16mm)
310-141	No 2 blade: 9¾" (246mm), blade ½" x ⅞" (13mm x 23mm)
310-142	No 3 blade: 9¾" (248mm), blade ¾" x 1" (18mm x 24mm)
310-143	No 4 blade: 10" (253mm), blade ½" x 1⅛" (14mm x 27mm)
310-144	No 5 blade: 10" (256mm), blade 1⅛" x 1⅛" (27mm x 29mm)
310-145	No 6 blade: 10" (252mm), blade 1" x 1⅝" (25mm x 40mm)zss

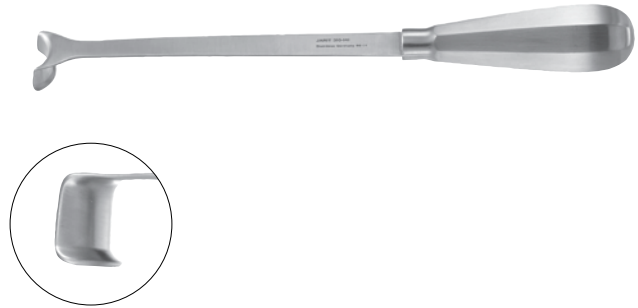

### Crawford Aortic Retractors

7½" (190mm)

Catalog #	Description
310-500	Small blade, width ⅝" x ¾" (15mm x 19mm)
310-502	Large blade, width ⅞" x ¾" (22.5mm x 20mm)



### Parsonnet Epicardial Retractors

3 x 3 Sharp Prongs

Catalog #	Description
310-508	1" (26mm)
310-507	1¼" (32mm)
310-506	1½" (38mm)
310-505	2" (50mm)

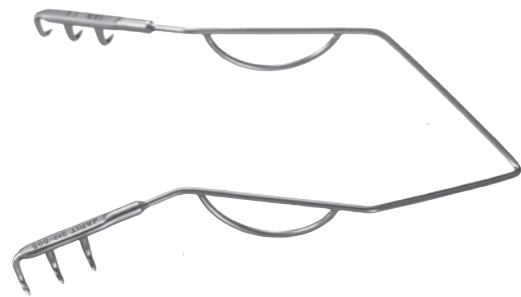

**Semb Lung Retractor**

9 3/4" (248mm)

Catalog #	Description
200-261	Small blade, 3/4" wide x 3/4" deep (18mm x 43mm)



**Henly Retractor, Improved Pattern**

with interchangeable lateral and center blades

Catalog #	Description
205-530	7" (180mm) Complete set includes:
205-FRM-530	Retractor frame only
205-532	1 pair lateral blades, blunt, 7/8" x 1" (22mm x 25mm)
205-534	1 pair lateral blades, blunt, 7/8" x 2" (22mm x 51mm)
205-536	1 pair lateral blades, blunt, 7/8" x 3" (22mm x 76mm)
205-540	1 center blade, 3/4" x 3/4" (18mm x 19mm)
205-542	1 center blade, 3/4" x 1" (18mm x 25mm)
205-544	1 center blade, 3/4" x 1 1/4" (18mm x 32mm)



**Henly Retractor, Original Pattern**

with 3 interchangeable center blades

Catalog #	Description
205-550	7" (180mm) Complete set includes:
205-RTB-550	1 retractor frame only
205-540	1 center blade, 3/4" x 3/4" (18mm x 19mm)
205-542	1 center blade, 3/4" x 1" (18mm x 25mm)
205-544	1 center blade, 3/4" x 1 1/4" (18mm x 32mm)

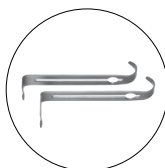



### Garrett Peripheral Vascular, Self-Retaining Retractor

Catalog #	Description
205-560	Retractor set consists of: retractor body and 3 pairs of (6) detachable blades
205-561	Garrett retractor body only, 7 <sup>1</sup> / <sub>4</sub> " (184mm)
205-562	Small blade, width, 1 <sup>1</sup> / <sub>2</sub> " x 1 <sup>1</sup> / <sub>4</sub> " (37mm x 32mm)
205-563	Medium blade, width, 1 <sup>1</sup> / <sub>2</sub> " x 2 <sup>1</sup> / <sub>4</sub> " (37mm x 57mm)
205-564	Large blade, width, 1 <sup>1</sup> / <sub>2</sub> " x 3 <sup>1</sup> / <sub>4</sub> " (37mm x 82mm)

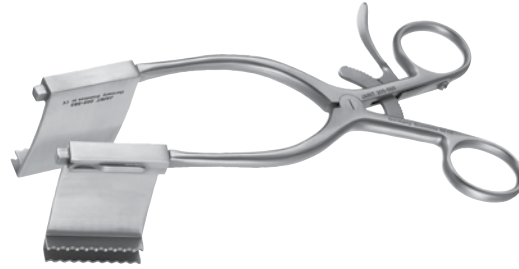
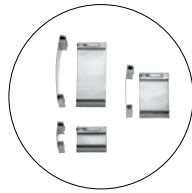

### Darling Popliteal Retractor, Self-Retaining

Catalog #	Description
205-260	Left: overall length 7" (184mm), total opening 3 <sup>3</sup> / <sub>4</sub> " (95mm) Short blade, width 1" (25mm), depth 2 <sup>5</sup> / <sub>8</sub> " (68mm), left Long blade, width 1 <sup>5</sup> / <sub>8</sub> " (40mm), depth 2 <sup>5</sup> / <sub>8</sub> " (68mm), left
205-261	Right: overall length 7" (184mm), total opening 3 <sup>3</sup> / <sub>4</sub> " (95mm) Short blade, width 1" (25mm), depth 2 <sup>5</sup> / <sub>8</sub> " (68mm), right Long blade, width 1 <sup>5</sup> / <sub>8</sub> " (40mm), depth 2 <sup>5</sup> / <sub>8</sub> " (68mm), right



### Ochsner Vascular Retractor, Self-Retaining, Swivel Blades, Flexible Arms

Catalog #	Description
205-570	Overall length 8" (203mm), Total Opening 5 <sup>1</sup> / <sub>2</sub> " (140mm) Arm length: 3 <sup>1</sup> / <sub>4</sub> " (83mm) Blades: width 1" (25mm), depth 2" (52mm)



### Finochietto Rib Spreaders, Curved Stainless Steel Arms

Catalog #	Description
300-100	Child size Spread: 5 <sup>5</sup> / <sub>8</sub> " (142mm) Arm length: 5 <sup>1</sup> / <sub>4</sub> " (138mm) Blades: 1 <sup>3</sup> / <sub>4</sub> " wide x 1 <sup>1</sup> / <sub>2</sub> " deep (45mm x 38mm)
300-105	Adult size, medium Spread: 8" (203mm) Arm length: 7 <sup>1</sup> / <sub>4</sub> " (184mm) Blades: 2 <sup>5</sup> / <sub>8</sub> " wide x 2" deep (67mm x 51mm)
300-115	Adult size, large Spread: 8 <sup>3</sup> / <sub>4</sub> " (222mm) Arm length: 7 <sup>1</sup> / <sub>4</sub> " (184mm) Blades: 2 <sup>3</sup> / <sub>4</sub> " wide x 2 <sup>5</sup> / <sub>8</sub> " deep (70mm x 66mm)



### Replacement Parts

Catalog #	Description
300-HDG-100	Replacement Handle/Gear
300-HDS-105	Replacement Handle/Gear

### Finochietto Infant Rib Spreader straight, stainless steel arms

Catalog #	Description
300-200	Spread: 3" (75mm) Arm length: 3" (75mm) Blades: <sup>3</sup> / <sub>4</sub> " x <sup>3</sup> / <sub>4</sub> " (19mm x 19mm)



### Finochietto Infant Rib Spreader curved stainless steel arms

Catalog #	Description
300-202	Spread: 2 <sup>3</sup> / <sub>4</sub> " (70mm) Arm length: 2 <sup>1</sup> / <sub>4</sub> " (58mm) Blades: <sup>7</sup> / <sub>8</sub> " x <sup>7</sup> / <sub>8</sub> " (21mm x 21mm)



**Finochietto Infant Rib Spreader-Approximator**

straight stainless steel arms

Catalog #	Description
300-225	Spread: 3 1/2" (89mm) Arm length: 2 5/8" (68mm) Blades: 7/8" x 3/4" (21mm x 19mm)



**Bailey-Finochietto Pediatric Rib Spreader**

arms and blades aluminum, ratchet bar stainless steel

Catalog #	Description
320-518	Spread: 2 1/2" (65mm) Arm length: 2 1/8" (55mm) Blades: 5/8" x 5/8" deep (15mm x 15mm)



**Titanium**

**Bailey-Finochietto Pediatric Rib Spreader**

Catalog #	Description
320-517TI	Spread: 2 3/4" (70mm) Arm length: 2 3/8" (60mm) Blades: 5/8" x 3/4" deep (16mm x 20mm)



### Haight Pediatric Rib Spreader

fixed stainless steel blades

Catalog #	Description
300-210	Spread: 4 <sup>3</sup> / <sub>4</sub> " (120mm) Arm length: 2 <sup>1</sup> / <sub>2</sub> " (64mm) Blades: 1 <sup>1</sup> / <sub>8</sub> " x 1 <sup>1</sup> / <sub>8</sub> " (30mm x 30mm)
300-211	Spread: 4 <sup>3</sup> / <sub>4</sub> " (120mm) Arm length: 3 <sup>1</sup> / <sub>2</sub> " (89mm) Blades: 1 <sup>1</sup> / <sub>8</sub> " x 1 <sup>1</sup> / <sub>8</sub> " (30mm x 30mm)



### Replacement Parts

Catalog #	Description
300-THC-211	Thumb Screw Assembly
300-HDS-105	Replacement Handle/Gear

### Haight-Finocchio Pediatric Rib Spreader

aluminum arms and blades, stainless steel ratchet bar

Catalog #	Description
300-213	Spread: 3 <sup>7</sup> / <sub>8</sub> " (98mm) Arm length: 3 <sup>1</sup> / <sub>8</sub> " (79mm) Blades: 1 <sup>1</sup> / <sub>4</sub> " x 1 <sup>1</sup> / <sub>8</sub> " (31mm x 27mm)



### Tuffier Rib Spreaders

Catalog #	Description
300-150	Roughened blades Spread: 6¾" (170mm) Arm length: 4¼" (108mm) Blades: 1⅞" wide x 2" deep (47mm x 51mm)
300-151	Grooved blades Spread: 6¾" (170mm) Arm length: 4¼" (108mm) Blades: 1⅞" wide x 2" deep (47mm x 51mm)



### Replacement Parts

Catalog #	Description
300-ST5-150	Replacement Locking Screw
300-TSG-150	Replacement Thumb Screw and Gear
300-TSG-151	Replacement Thumb Screw and Gear

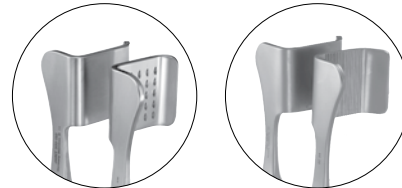

### Burford Rib Spreader

Catalog #	Description
300-175	2 pair of interchangeable blades, arms and blades stainless steel, Spread: 7¾" (197mm) Arm length: 7¾" (197mm) Small blades: 1¼" wide x 2½" deep (32mm x 65mm) Large blades: 2½" wide x 3¼" deep (65mm x 82mm)



### Replacement Parts

Catalog #	Description
300-BLD-175	Replacement Set of 4 Blades
300-HDG-175	Replacement Handle/Gear
300-LBL-175IL	Replacement Large Blade Left
300-LBL-175IR	Replacement Large Blade Right
300-SBL-175IL	Replacement Small Blade Left
300-SBL-175IR	Replacement Small Blade Right
300-LBL-175	Replacement Large Blade 1PR
300-SBL-175	Replacement Small Blade 1PR
300-SLB-175	Replacement Slide Bar Lock
300-KLS-175	Replacement Knurled Lock Screw 1 PR



### Burford Rib Spreader

Catalog #	Description
300-180	2 pair of interchangeable blades, arms and blades aluminum, Spread: 8" (203mm) Arm length: 7½" (192mm) Small blades: 1⅝" wide x 2⅛" deep (40mm x 60mm) Large blades: 2⅜" wide x 2⅜" deep (60mm x 60mm)



### Replacement Parts

Catalog #	Description
300-SBL-180	Replacement Small Blade Set
300-SBL-180IL	Replacement Small Blade Left
300-SBL-180IR	Replacement Small Blade Right
300-LBL-180IL	Replacement Large Blade Left
300-LBL-180IR	Replacement Small Blade Right
300-LBL-180	Replacement Large Blade Set

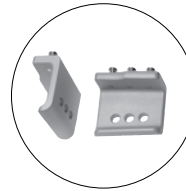

### Burford-Finochietto Rib Spreader

Catalog #	Description
300-183	Infant-child Size, 4 pairs of blades, Spread: 6" (154mm) Arm length: 4¼" (108mm) Blade #1: ⅞" x ⅞" (22mm x 23mm) Blade #2: 1⅛" x 1¼" (29mm x 32mm) Blade #3: 1⅛" x 1¾" (29mm x 44mm) Blade #4: 1⅞" x 1¾" (48mm x 44mm)

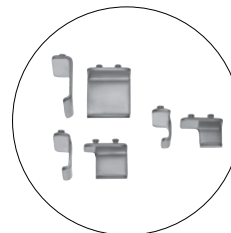

### Harken Rib Spreader and Scalpula Retractor

Catalog #	Description
300-185	2 pair of stainless steel blades, Spread: 11" (280mm) Arm length: 8¼" (210mm) Fixed blades: 2½" x 1⅞" (65mm x 49mm) Scalpula blades: 2" x 2" (51mm x 51mm)



### Replacement Parts

Catalog #	Description
300-BLS-185	Replacement Scalpula Blades



### Ankeney Sternal Retractor, Adult

six swivel blades, with suture holding springs

Catalog #	Description
300-165	Spread: 7½" (190mm) Arm length: 11¾" (300mm) Blades: 1⅜" x 1¼" deep (35mm x 32mm)
300-166	Set of 6 blades: 1⅜" x 2" (35mm x 52mm)



### Ankeney Sternal Retractor, Child

aluminum arms with stainless steel rack

Catalog #	Description
300-160	Spread: 4⅞" (125mm) Arm length: 4½" (115mm) Blades: ¾" x 1" deep (20mm x 25mm)



### Himmelstein Sternal Retractor

stainless steel

Catalog #	Description
300-205	Spread: 6" (152mm) Arm length: 5¾" (145mm) Blades: 1¾" x 1¼" deep (35mm x 32mm)



### Morse Sternal Retractor

stainless steel, child size

Catalog #	Description
300-250	Spread: 6" (152mm) Arm length: 4¾" (121mm) Blades: 7⁄8" x 5⁄8" (22mm x 16mm)



### Morse Sternal Retractor

stainless steel, adult size

Catalog #	Description
300-251	Spread: 7¾" (195mm) Arm length: 6" (152mm) Blades: 1½" x 1" (29mm x 24mm)



### Replacement Parts

Catalog #	Description
300-BLS-251	Replacement Set of Blades 1 Set
300-HDG-251	Replacement Handle
300-HDG-253	Replacement Gear



### Favaloro-Morse Sternal Retractor

stainless steel

Catalog #	Description
300-253	Spread: 7¾" (195mm) Arm length: 6" (152mm) Blades: 1⅝" x 1⅛" (42mm x 29mm)

#### Replacement Parts

Catalog #	Description
300-SRW-253	Replacement Screw
300-BLS-253	Replacement Blade Set 1 Set (4)
300-HDG-251	Replacement Handle
300-HDG-253	Replacement Gear

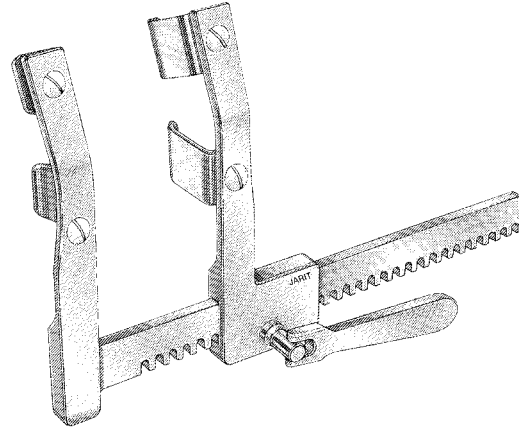

### Cooley Sternal Retractors

stainless steel

Catalog #	Description
300-260	Child size Spread: 5⅞" (130mm) Arm length: 4½" (113mm) Blades: 1¾" x 1" (46mm x 25mm)
300-261	Adult size Spread: 6½" (165mm) Arm length: 5½" (140mm) Blades: 2" x 1⅜" (51mm x 34mm)
300-262	Extra large size Spread: 7¾" (194mm) Arm length: 6¼" (158mm) Blades: 4" x 1⅛" (102mm x 29mm)



#### Replacement Parts

Catalog #	Description
300-HDG-261	Replacement Handle/Gear

### Cooley Neonatal Sternal Retractor

arms and blades aluminum, ratchet bar stainless steel

Catalog #	Description
320-510	Spread: 3 1/8" (79mm) Arm length: 2 1/8" (54mm) Blades: 5/8" x 3/8" (17mm x 10mm)



### Cooley Pediatric Sternal Retractor

arms and blades aluminum, ratchet bar stainless steel

Catalog #	Description
320-515	Spread: 3 1/8" (79mm) Arm length: 2 1/4" (58mm) Blades: 5/8" x 1/2" (16mm x 14mm)
320-516	Spread: 4" (102mm) Arm length: 3" (77mm) Blades: 3/4" x 5/8" (19mm x 17mm)
320-514	Spread: 4 5/8" (117mm) Arm length: 3 1/8" (79mm) Blades: 1 1/8" x 3/4" (30mm x 20mm)



### Castaneda Sternal Retractors

arms and blades aluminum, ratchet bar stainless steel

Catalog #	Description
300-190	Newborn size Spread: 2 1/2" (65mm) Arm length: 2 3/8" (60mm) Blades: 1 3/8" x 1/2" (34mm x 13mm)
300-192	Infant size Spread: 3 1/8" (80mm) Arm length: 3 1/8" (80mm) Blades: 1 3/4" x 1/2" (45mm x 13mm)
300-194	Child size Spread: 4 3/4" (120mm) Arm length: 5" (127mm) Blades: 2 3/8" x 3/4" (60mm x 17.5mm)



### Bailey Rib Contractor, Adult

Catalog #	Description
300-230	7¾" (194mm)

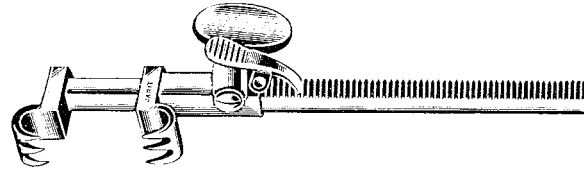

#### Replacement Parts

Catalog #	Description
300-THC-230	Replacement Thumbscrew Assembly

### Bailey Rib Contractor, Pediatric

Catalog #	Description
300-231	6" (154mm)

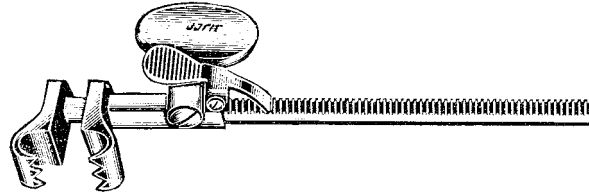

#### Replacement Parts

Catalog #	Description
300-THC-230	Replacement Thumbscrew Assembly

### Bailey-Gibbon Rib Contractor

Catalog #	Description
300-235	7¾" (194mm)

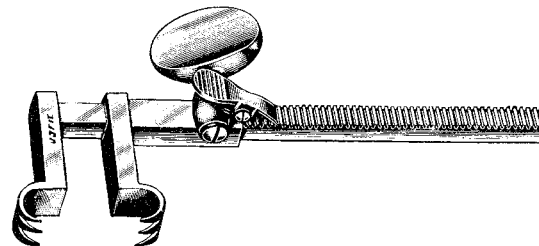

#### Replacement Parts

Catalog #	Description
300-THC-230	Replacement Thumbscrew Assembly
300-SGA-235	Replacement Screw Gear Assembly

### Lemmon Sternal Approximator, Adult

Catalog #	Description
300-238	7" (180mm)

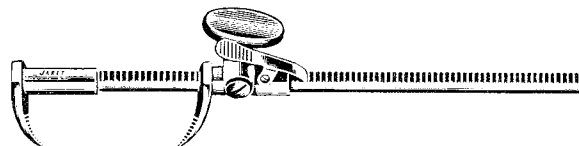

ALL DIMENSIONS ARE APPROXIMATE

Catalog #

**NEWBORN**

Castaneda	300-190	Aluminum body and frame
Castaneda	300-192	Aluminum body and frame
Cooley	320-510	Aluminum arms and blades, Stainless Steel ratchet bar
Bailey-Finochietto	320-518	Aluminum body and frame
Bailey-Finochietto	320-517TI	Titanium

**INFANT TO YOUNG CHILDREN**

Cooley	320-515	Aluminum arms and blades, Stainless Steel ratchet bar
Cooley	320-516	Aluminum arms and blades, Stainless Steel ratchet bar
Cooley	320-514	Aluminum arms and blades, Stainless Steel ratchet bar
Castaneda	300-194	Aluminum body and frame
Finochietto	300-225	
Finochietto	300-200	
Haight-Finochietto	300-213	Aluminum arms and blades, Stainless Steel ratchet bar
Finochietto	300-202	
Haight	300-210	
Haight	300-211	

**OLDER CHILD 6-10 YEARS**

Ankeney	300-160	
Cooley	300-260	
Morse	300-250	
Cooley	300-261	
Finochietto	300-100	
Burford	300-183	
Tuffier	300-151	
Tuffier	300-150	

**ADULT**

Ankeney	300-165	
Blades	300-166	
Himmelstein	300-205	
Cooley	300-262	
Morse	300-251	
Favaloro-Morse	300-253	
Burford	300-180	Aluminum arms and blades, Stainless Steel ratchet bar
Small Blades		
Large Blades		
Finochetto-Medium	300-105	
Finochetto	300-115	
Buford	300-175	
Small Blades		
Large Blades		
Harken	300-185	
Fixed Blades		
Scapula Blades		

Blade Style	Maximum Spread	Blade Width	Blade Depth	Arm Length	Page #
Sternal, Single, Fixed	2 1/2" (6.5cm)	1 1/4" (3.3cm)	1/2" (1.3cm)	2 1/8" (5.4cm)	358
Sternal, Single, Fixed	2 1/2" (8.8cm)	1 3/4" (4.5cm)	5/8" (1.7cm)	3 1/8" (7.9cm)	358
Sternal, Single, Fixed	2 3/4" (7cm)	1 1/16" (1.7cm)	1/2" (1.4cm)	2 1/8" (5.5cm)	358
Rib, Single, Fixed	2 1/2" (6.5cm)	1/2" (1.5cm)	1/2" (1.5cm)	2 1/8" (5.5cm)	351
Rib, Single, Fixed	2 7/8" (7.2cm)	3/4" (2cm)	3/4" (2cm)	2 1/4" (5.9cm)	351
Sternal, Single, Fixed	3 3/8" (8.7cm)	5/8" (1.6cm)	5/8" (1.6cm)	2 1/4" (5.6cm)	358
Sternal, Single, Fixed, with Teeth	3 1/2" (8.9cm)	3/4" (1.9cm)	3/4" (1.9cm)	3" (7.6cm)	358
Sternal, Single, Fixed	3 3/4" (9.6cm)	1 1/8" (2.9cm)	7/8" (2cm)	3" (7.8cm)	358
Sternal, Single, Fixed	4 1/8" (10.5cm)	2 3/8" (6cm)	7/8" (2.2cm)	5" (12.8cm)	358
Rib, Single, Fixed, with Rib Approximator	3" (7.5cm)	3/4" (2cm)	7/8" (2.2cm)	2 3/8" (6cm)	351
Rib, Single, Fixed, Straight Arms	3 1/4" (8.3cm)	3/4" (1.9cm)	3/4" (1.9cm)	2 3/4" (7cm)	350
Rib, Single, Fixed	3 1/2" (9cm)	1 3/16" (3cm)	1 3/8" (3.5cm)	3 1/8" (8cm)	352
Rib, Single, Fixed, Curved Arms	3 3/4" (6.9cm)	3/4" (2.1cm)	7/8" (2.2cm)	2 1/4" (5.6cm)	350
Rib, Single, Fixed	4 3/4" (12cm)	1 3/16" (3cm)	1 3/8" (3.5cm)	2 1/2" (6.4cm)	352
Rib, Single, Fixed	4 3/4" (12cm)	1 3/16" (3cm)	1 3/8" (3.5cm)	3 1/2" (9cm)	352
Sternal, 4 Swivel Blades	4 3/4" (12cm)	3/4" (1.9cm)	1" (2.5cm)	4 1/2" (11.4cm)	355
Sternal, Single, Fixed	5 1/4" (13.3cm)	1 3/4" (4.5cm)	1" (2.7cm)	4 1/2" (11.4cm)	357
Sternal, 4 Swivel Blades	6" (15.5cm)	7/8" (2.2cm)	5/8" (1.8cm)	4 7/8" (12.4cm)	356
Sternal, Single, Fixed	6 1/2" (16.5cm)	1 1/2" (3.9cm)	2" (5.1cm)	5 1/2" (13.9cm)	357
Rib, Single, Fixed, Curved Arms	5 1/2" (13.8cm)	1 3/4" (4.4cm)	1 3/4" (4.3cm)	5 1/4" (13.5cm)	350
Rib, Single, Interchangeable	6 1/4" (16cm)		1" (2.3cm)	4 1/8" (10.5cm)	354
			1 1/4" (3.3cm)	1" (2.5cm)	
			1 3/4" (4.3cm)	1 3/8" (3.5cm)	
			1 3/4" (4.3cm)	1 3/8" (3.5cm)	
			1 3/4" (4.3cm)	2" (5cm)	
Rib, Single, Fixed, Grooved Blades	6 7/8" (17.4cm)	1 3/4" (4.4cm)	2" (5.1cm)	4 1/4" (10.8cm)	353
Rib, Single, Fixed, Roughened Blades	6 7/8" (17.4cm)	1 3/4" (4.4cm)	2" (5.1cm)	4 1/4" (10.8cm)	353
Sternal, 6 Swivel Blades	7" (19.7cm)	1 3/8" (3.5cm)	1 3/8" (3.5cm)	13" (33cm)	355
			1 3/8" (3.5cm)	2" (5.2cm)	355
Sternal, Single, Swivel Blades	7 1/4" (18.5cm)	1 3/8" (3.5cm)	1 1/8" (3cm)	5 3/4" (14.7cm)	356
Sternal, Fixed	7 1/4" (18.5cm)	4" (10.2cm)	1 1/8" (3cm)	6" (15.5cm)	357
Sternal, 4 Swivel Blades	9" (23cm)	1 1/8" (2.9cm)	1" (2.4cm)	5 3/4" (14.7cm)	356
Sternal, 4 Swivel Blades	9" (23cm)	1 1/8" (3cm)	1 1/2" (4cm)	6" (15.2cm)	357
Rib, Single, Interchangeable	7" (17.5cm)		2 1/2" (6.2cm)	7 5/8" (19.5cm)	354
			2 1/2" (6.2cm)	2" (5.3cm)	
			2 1/2" (6.2cm)	2 7/8" (7.3cm)	
Rib, Single, Fixed, Medium, Curved Arms	7 7/8" (20cm)	2 5/8" (6.6cm)	2 1/8" (5.5cm)	7 1/4" (18.4cm)	350
Rib, Single, Fixed, Large, Curved Arms	7 7/8" (20cm)	2 5/8" (6.6cm)	2 7/8" (7.3cm)	7 1/4" (18.4cm)	350
Rib, Single, Interchangeable	8" (20.5cm)		7 5/8" (19.5cm)	353	
			2 1/2" (6.4cm)	2" (5cm)	
			2 1/2" (6.4cm)	3 1/8" (8cm)	
Rib, Single, Fixed, with Scapula Blades	11" (28cm)		8 1/2" (21.5cm)	355	
			2 1/2" (6.4cm)	2" (5.3cm)	
			2" (4.9cm)	2" (5.1cm)	

**Plain Rib Shears**

Catalog #	Description
300-300	9" (230mm)

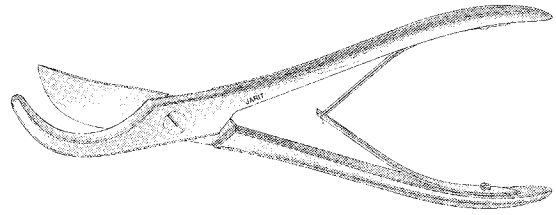

**Gluck Rib Shears**

Catalog #	Description
300-302	7½" (190mm)

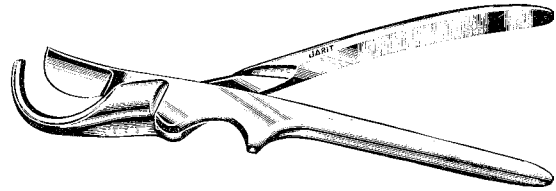

**Sauerbruck Rib Shears**

Catalog #	Description
300-304	10" (256mm)

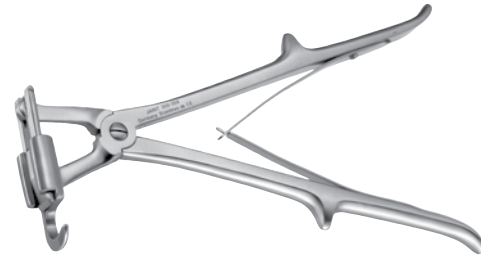

**Stille-Giertz Rib Shears**

Catalog #	Description
300-305	10" (252mm)



**Bethune Rib Shears**

Catalog #	Description
300-310	14" (353mm)



**Replacement Parts**

Catalog #	Description
300-SPS-310	Replacement Spring and Screw



**Bethune-Coryllos Rib Shears, Left**

<u>Catalog #</u>	<u>Description</u>
300-315	14½" (370mm)



**Bethune-Coryllos Rib Shears, Right**

<u>Catalog #</u>	<u>Description</u>
300-316	14½" (370mm)

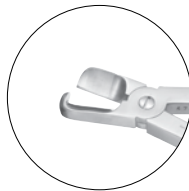

### Ruskin-Liston Bone Splitting Forceps

14mm cutting jaw, narrow jaw

Catalog #	Description
230-310	7¼" (182mm), straight
230-311	7¼" (182mm), up-angled
230-SPS-305	Replacement Spring and Screws
230-SPS-306	Replacement Spring and Screws



### Stille-Liston Bone Cutting Forceps

Catalog #	Description
230-320	10¾" (270mm), straight, 32.7mm cutting jaws
230-321	10¾" (270mm), up-angled, 27.3mm cutting jaws

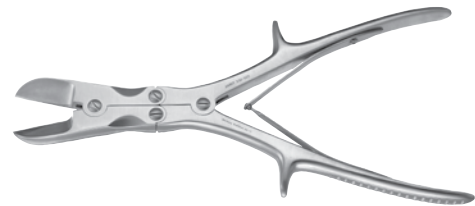

### Stille-Horsley Bone Cutting Forceps

Catalog #	Description
230-325	9¾" (250mm), S-shaped, 25mm cutting edge



### Ruskin-Mini Bone Rongeurs

Catalog #	Description
230-195	6" (155mm), straight, 2mm bite
230-196	6" (155mm), curved, 2mm bite
230-197	6" (155mm), full curved, 3mm bite
230-200	6" (155mm), curved, 4mm bite

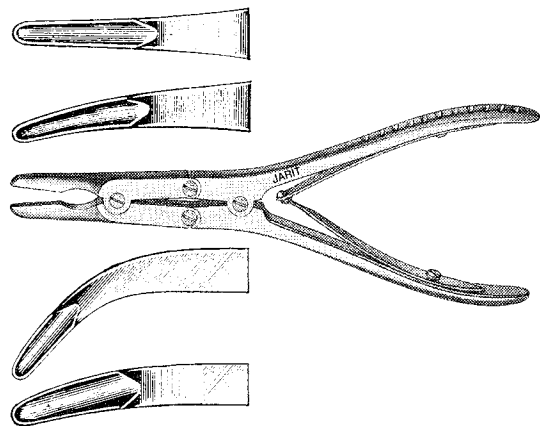

### Replacement Parts

Catalog #	Description
230-SPS-196	Replacement Spring and Screw



**Ruskin Rongeurs**

Catalog #	Description
230-210	7¼" (185mm), straight, 5mm bite
230-211	7¼" (185mm), curved, 5mm bite
230-214	7¼" (185mm), straight, 6mm bite
230-215	7¼" (185mm), curved, 6mm bite



**Ruskin-Jay Rongeur**

Catalog #	Description
230-216	8" (202mm), heavy duty, light curved, 6mm bite



**Ruskin Angular Duckbill Rongeur**

Catalog #	Description
230-218	7¼" (181mm), 6mm bite



**Stille- Luer Rongeurs**

straight, 10mm bite

Catalog #	Description
230-230	8¾" (225mm)
230-235	10" (255mm)

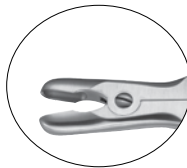

**Stille- Luer Rongeurs**

curved, 10mm bite

Catalog #	Description
230-231	8¾" (225mm)
230-236	10" (255mm)

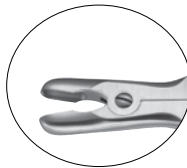

**Stille- Luer Angular Duckbill Rongeur**

9" (230mm)

Catalog #	Description
230-240	6mm bite

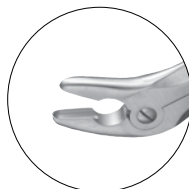

**Echlin Angular Duckbill Rongeurs**

Catalog #	Description
230-245	9" (230mm), 2mm bite
230-246	9" (230mm), 3mm bite
230-247	9" (230mm), 4mm bite
230-SPS-246	Replacement Spring and Screw

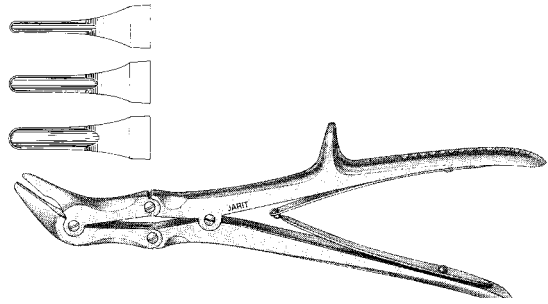

**Stille-Luer-Echlin Angular Duckbill Rongeur**

Catalog #	Description
230-250	9" (230mm), 6mm bite

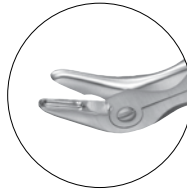

**Leksell Rongeurs**  
slight curve

Catalog #	Description
230-260	9 1/4" (237mm), 3mm bite
230-261	9 1/4" (237mm), 8mm bite
230-262	9 1/4" (237mm), 5mm bite

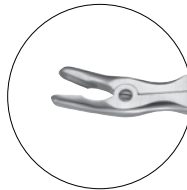

**Dale Thoracic Rongeurs**  
3mm bite, slight curve

Catalog #	Description
230-280	13 1/2" (343mm)



**Sauerbruch Rib Rongeurs**  
square bite

Catalog #	Description
230-275	12" (305mm), 5/8" (16mm) wide jaw
230-276	12" (305mm), 3/4" (19mm) wide jaw

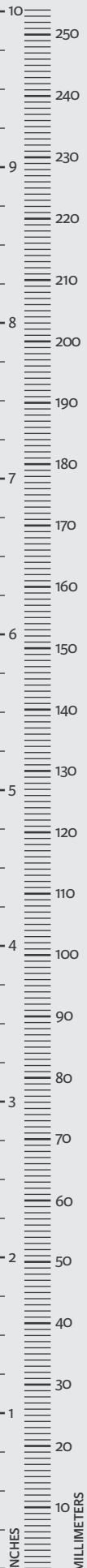
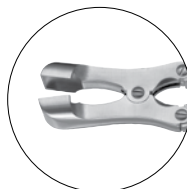

### Doyen Raspatories

Catalog #	Description
300-400	6½" (165mm), 6mm x 40mm large blade, left
300-402	6½" (165mm), 6mm x 40mm large blade, right
300-405	7¼" (183mm), 5mm x 29mm small blade, left
300-407	7¼" (183mm), 5mm x 29mm small blade, right

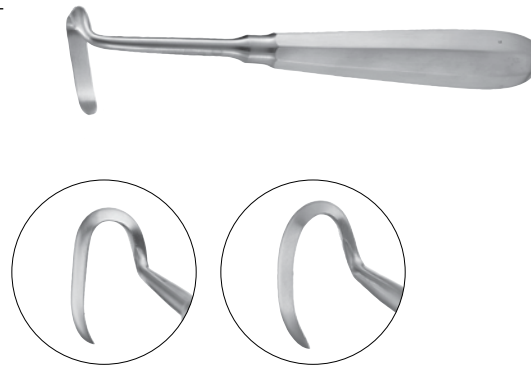

### Matson-Alexander Rib Stripper

Catalog #	Description
300-410	8½" (215mm)



### Matson Rib Stripper and Elevator

Catalog #	Description
300-411	8¾" (221mm)



### Alexander-Farabeuf Periosteotome

Catalog #	Description
300-415	8¼" (209mm)



### Alexander Periosteotome, Pediatric

Catalog #	Description
300-416	5⅞" (148mm)



### Lebsche Sternum Knife

Catalog #	Description
300-425	9¾" (245mm)



**Adson Dura Hook**

Catalog #	Description
285-225	7¾" (200mm), 6.5mm long, sharp tip



**Adson Dura Hook**

Catalog #	Description
285-227	8" (202mm), 7mm long, blunt tip



**Dandy Nerve Hook**

Catalog #	Description
285-230	9" (230mm), 5mm long, blunt tip



**Smithwick Sympathectomy Hook and Dissector**

Catalog #	Description
285-315	12¼" (312mm)



**Penfield Dissector No. 4, Slightly Curved**

Catalog #	Description
285-368	8" (205mm)



**Freer Double-Ended Elevators**

7¾" (195mm), sharp-blunt blades

Catalog #	Description
285-379	6.5mm blades
285-380	4.5mm blades



### Metzenbaum-Nelson Scissors, Stainless

Catalog #	Description
305-100	9¼" (235mm), straight
305-101	9¼" (232mm), curved
305-105	11¼" (286mm), straight
305-106	11¼" (286mm), curved
305-110	14½" (367mm), curved

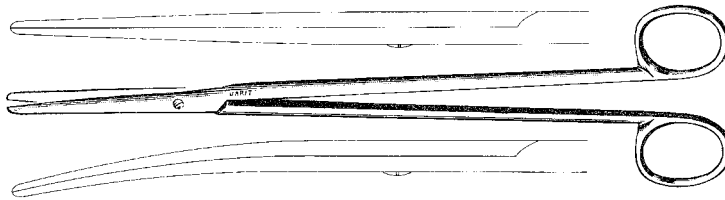

### Metzenbaum-Nelson Scissors, Carb-Edge

Catalog #	Description
101-266	9¼" (233mm), straight, blunt tips
101-267	9¼" (233mm), curved, blunt tips
101-275	9¼" (233mm), straight, delicate tips
101-276	9¼" (233mm), curved, delicate tips
101-278	9¼" (233mm), straight, sharp tips
101-279	9¼" (233mm), curved, sharp tips
101-269	10¼" (260mm), curved, blunt tips
101-270	11¼" (285mm), curved, blunt tips
101-272	12¼" (310mm), curved, blunt tips
101-256	14¼" (364mm), curved, blunt tips

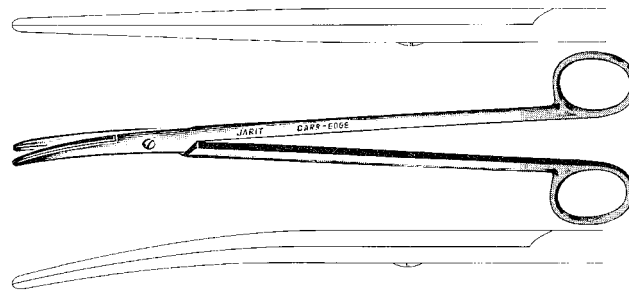

### Metzenbaum Scissors, Supercut

Catalog #	Description
102-122	7" (180mm), curved
102-125	9¼" (232mm), curved
102-126	10¼" (260mm), curved
102-128	11¼" (285mm), curved
102-129	12" (302mm), curved
102-127	14" (356mm), curved

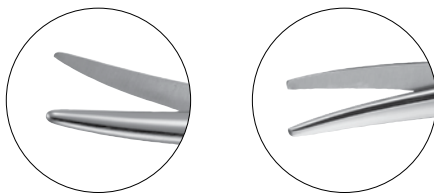

### Jorgenson Scissors

Catalog #	Description
305-120	8¾" (222mm)



### Cooley Scissors

Catalog #	Description
305-125	7½" (191mm)



### Willauer Scissors

Catalog #	Description
305-130	10¼" (260mm), straight
305-131	10¼" (260mm), curved
305-135	12" (305mm), straight
305-136	12" (303mm), curved

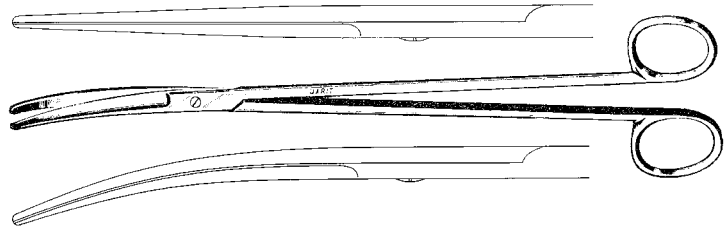

### Mayo-Harrington Scissors

Catalog #	Description
305-140	9" (230mm), straight
305-141	9" (230mm), curved
305-145	11" (280mm), straight
305-146	11" (280mm), curved

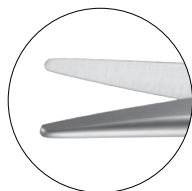

### Mayo-Harrington Scissors, Carb-Edge

Catalog #	Description
101-225	9" (230mm), straight
101-226	9" (230mm), curved
101-230	14¼" (361mm), straight
101-232	14¼" (361mm), curved

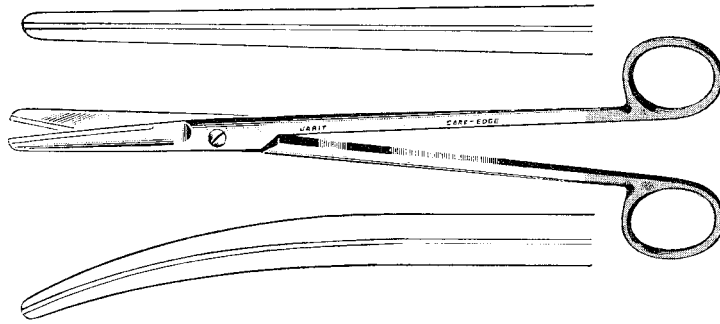

### Mayo-Harrington Scissors, Supercut

Catalog #	Description
102-115	9" (230mm), straight
102-116	9" (230mm), curved
102-113	10" (256mm), straight
102-118	11" (280mm), curved
102-114	12" (305mm), straight

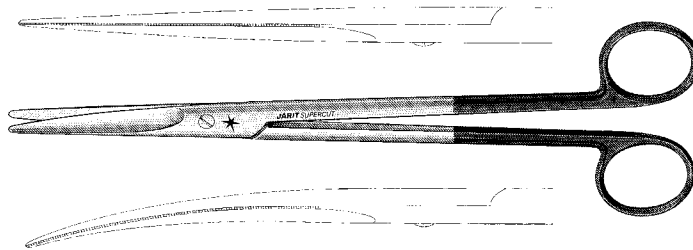

**Lillehei-Potts Scissors, 7" (180mm)**

Catalog #	Description
100-240	Straight blades, blunt tips
100-241	Curved blades, blunt tips
100-242	Straight blades, sharp tips
100-243	Curved blades, sharp tips
100-244	Straight blades, tenotomy tips
100-245	Curved blades, tenotomy tips

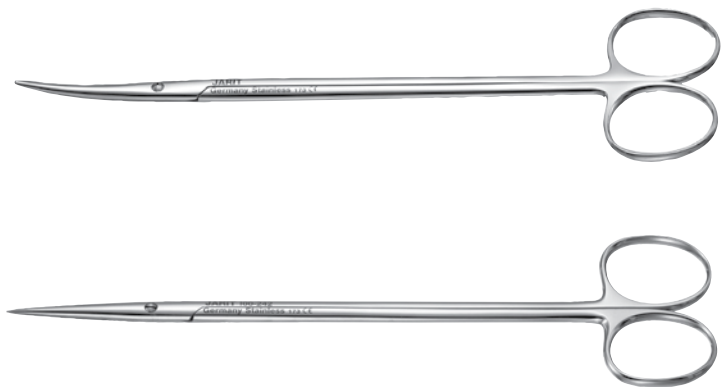

**Lillehei-Potts Scissors, 9" (230mm), Supercut**

Catalog #	Description
102-305	Curved blades, 34mm sharp tips
102-306	Curved blades, 34mm blunt tips
102-307	Curved blades, 14mm tenotomy tips

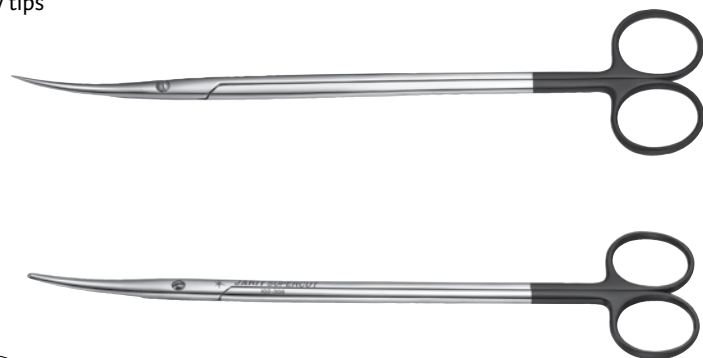



**Reynolds Scissors, Narrow Tip, Curved**

Catalog #	Description
100-295	5 5/8" (143mm), plain edge, very narrow tips
100-296	5 5/8" (143mm), serrated edge, very narrow tips
100-297	7" (179mm), plain edge, very narrow tips
100-298	7" (179mm), serrated edge, very narrow tips

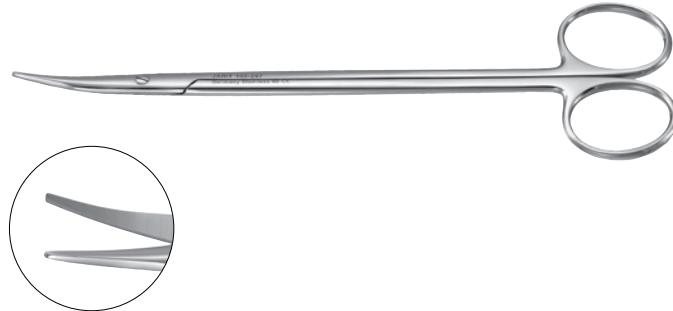

**Jamison-Metzenbaum Scissors, Narrow Tip, Curved**

Catalog #	Description
100-300	6" (155mm)
100-302	7" (180mm)
100-304	8" (205mm)
100-306	9" (230mm)

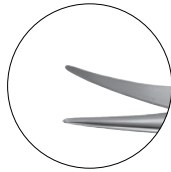

**Jamison-Metzenbaum Scissors, Supercut, Curved**

Catalog #	Description
102-300	5 5/8" (143mm)
102-302	7" (180mm)



**Metzenbaum Scissors, Delicate Pattern (Mirror Finish)**

Catalog #	Description
100-261	7" (178mm), curved

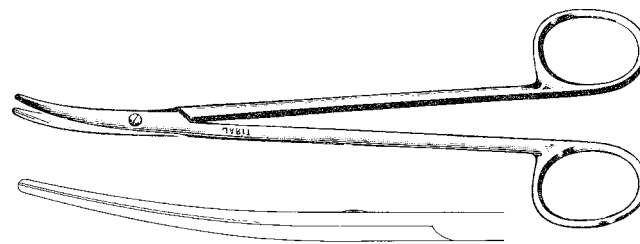

**Metzenbaum-Lahey Scissors, Carb-Edge**

Catalog #	Description
101-251	5 3/4" (145mm), curved

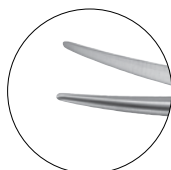

**Metzenbaum Scissors, Carb-Edge**

Catalog #	Description
101-258	7" (179mm), curved, blunt/blunt tips
101-259	7" (179mm), curved, delicate sharp/sharp tips
101-260	7" (179mm), straight, delicate, blunt/blunt tips
101-261	7" (179mm), curved, delicate, blunt/blunt tips
101-265	8" (206mm), curved, blunt/blunt tips

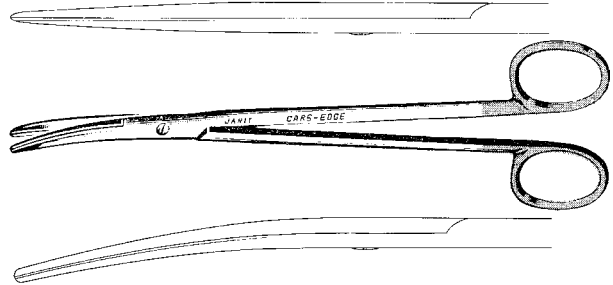

**Metzenbaum Scissors, Supercut**

Catalog #	Description
102-120	5 5/8" (143mm), curved
102-122	7" (180mm), curved
102-310	7" (180mm), curved, delicate
102-311	7 3/4" (200mm), curved, delicate
102-125	9 1/4" (232mm), curved
102-126	10 1/4" (260mm), curved
102-128	11 1/4" (285mm), curved
102-129	12" (302mm), curved
102-127	14" (356mm), curved

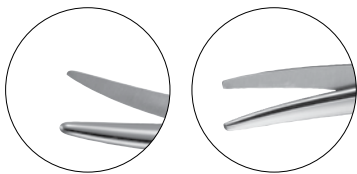

**Reynolds, Petit Point Scissors, Carb-Edge**

curved, one blade serrated

Catalog #	Description
101-255	5 1/8" (130mm)

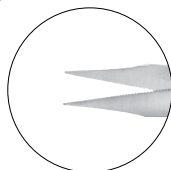

### Reynolds, Petit Point Scissors, Supercut

Catalog #	Description
102-245	5 1/8" (129mm), curved, tenotomy tips

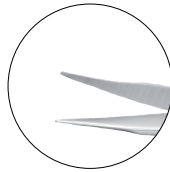

### Flat Tip Scissors, Tenotomy Tips, Supercut

Catalog #	Description
102-313	7" (177mm), curved

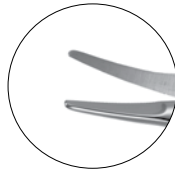

### Potts-Smith Dissecting Scissors, Curved

Catalog #	Description
310-290	5 3/4" (145mm)
310-291	7 1/4" (184mm)
310-292	9 1/4" (232mm)



### Satinsky Vascular Scissors

Catalog #	Description
310-300	9 1/2" (243mm), curved shanks, acutely curved tips



### DeMartel Vascular Scissors, Curved

Catalog #	Description
310-302	6 3/4" (174mm), blunt tips
310-303	6 3/4" (172mm), sharp tips

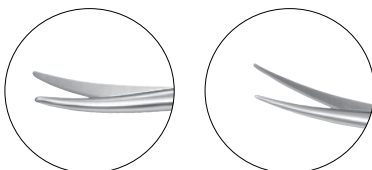

**Endarterectomy Vascular Scissors**

Catalog #	Description
310-330	6¾" (172mm), curved

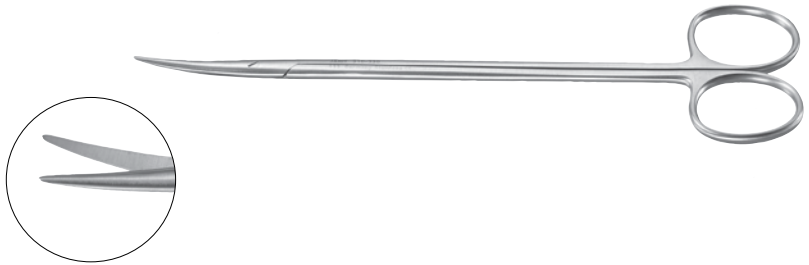

**Endarterectomy Vascular Scissors, Supercut**

Catalog #	Description
102-315	6¾" (173mm), curved

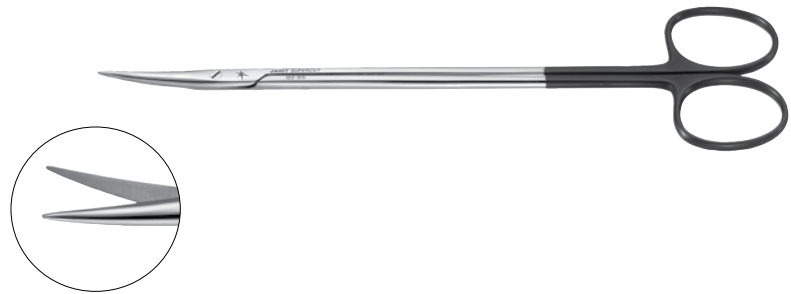

**DeBakey Endarterectomy Vascular Scissors**

Catalog #	Description
310-349	7" (178mm), full curve

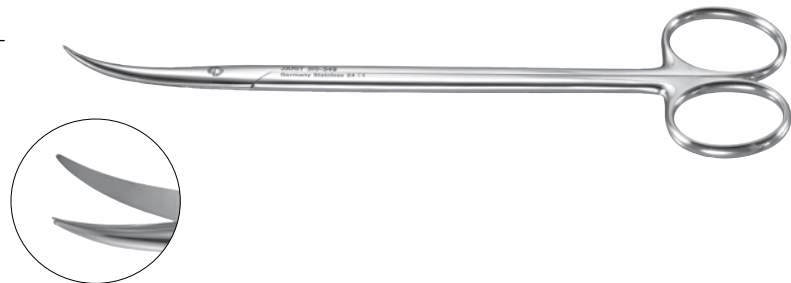

**Lincoln Vascular Scissors**

Catalog #	Description
310-367	10" (255mm), straight
310-368	10" (254mm), curved
310-369	6¾" (174mm), straight
310-370	6¾" (173mm), curved

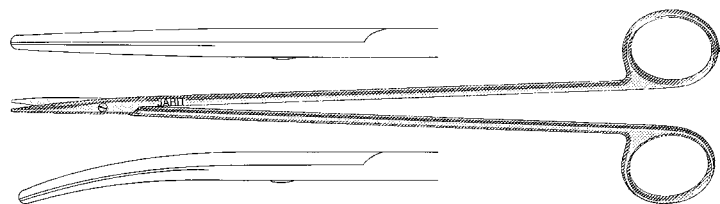

### Church Vascular Scissors

Catalog #	Description
310-375	7" (175mm), straight
310-376	7" (175mm), curved

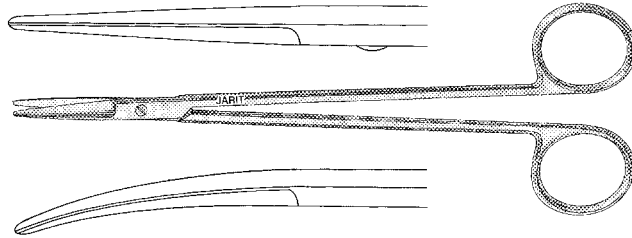

### Mattox-Potts Scissors

Catalog #	Description
310-304	5 3/8" (137mm), 45° angle, 22mm blades



### You-Potts Scissors, Fine 10mm Blades

Catalog #	Description
310-305	7" (178mm), 45° angle
310-306	7" (178mm), 90° angle
310-307	7" (178mm), 120° angle

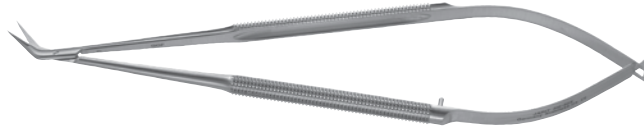
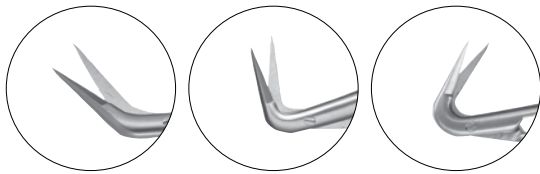

### Yasargil Vascular Scissors, Bayonet Handle

Catalog #	Description
310-308	7 3/4" (195mm), 45° angle, 13mm blades

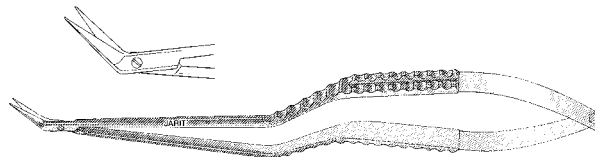

310-309	7" (178mm), left circumflex coronary artery scissors, 125° angle, 10.5mm reverse angle blades
---------	---

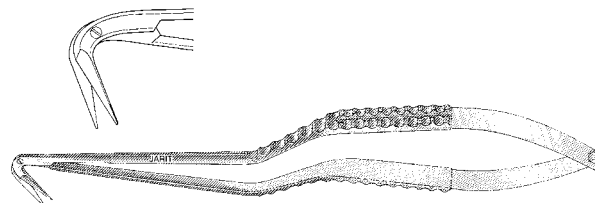

**Potts-Smith Vascular Scissors**

Catalog #	Description
310-310	7½" (189mm), 25° angle, 22mm blades
310-315	7¼" (185mm), 45° angle, 22mm blades
310-320	7" (180mm), 60° angle, 19mm blades

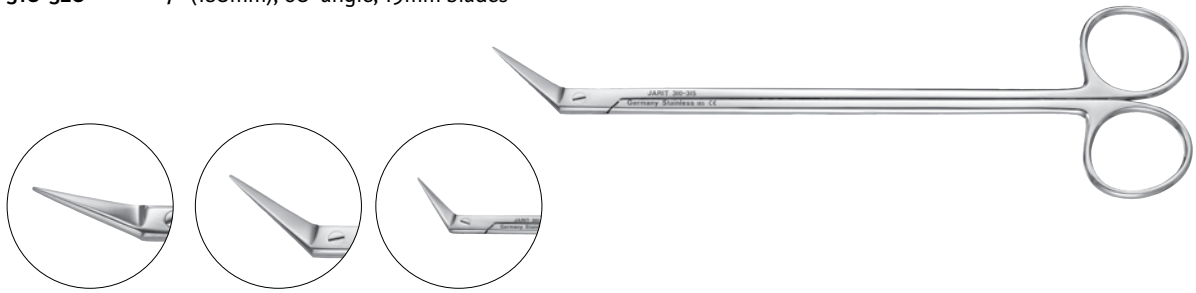

**Potts-Smith Vascular Scissors, Supercut**

Catalog #	Description
102-320	7½" (189mm), 25° angle, 22mm blades
102-321	7¼" (185mm), 45° angle, 20mm blades
102-322	7" (180mm), 60° angle, 19mm blades

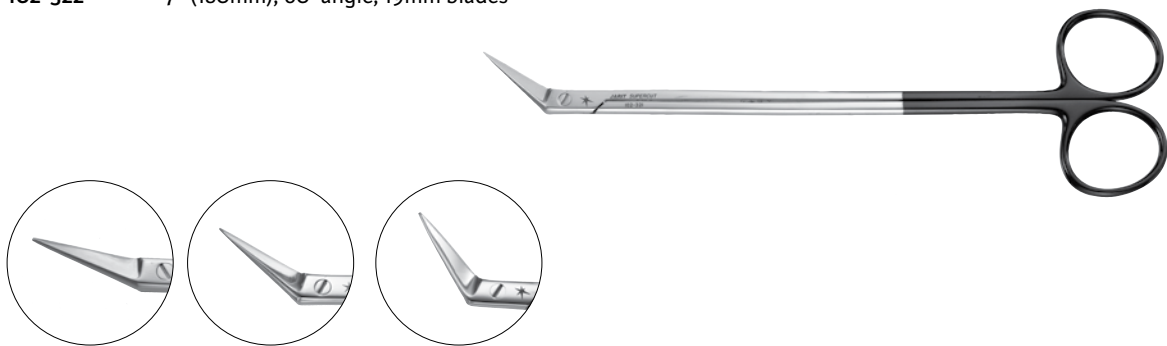

**DeBakey-Potts Vascular Scissors, 23mm Blades**

Catalog #	Description
310-332	6½" (168mm), 25° angle
310-333	6½" (168mm), 45° angle
310-334	6¼" (158mm), 60° angle

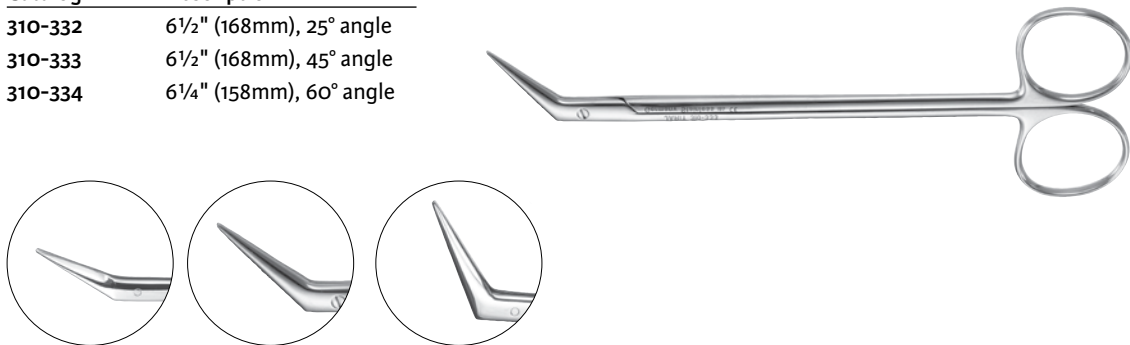

### DeBakey Vascular Scissors, 23mm Blades

Catalog #	Description
310-340	6½" (168mm), 25° angle
310-341	6½" (168mm), 45° angle
310-342	6¼" (158mm), 60° angle
310-343	9" (230mm), 25° angle
310-344	9" (230mm), 45° angle
310-345	8¾" (221mm), 60° angle



### Diethrich Coronary Artery Scissors

Catalog #	Description
310-350	7" (182mm), 12mm blades, 25° angle
310-351	7" (180mm), 13mm blades, 45° angle
310-352	7" (177mm), 13mm blades, 60° angle
310-353	7" (172mm), 13.5mm blades, 90° angle
310-354	7" (172mm), 12.5mm blades, 125° angle



### Diethrich Coronary Artery Scissors, Extra Delicate Blade

Catalog #	Description
311-350	7" (182mm), 14mm blades, 25° angle
311-351	7" (180mm), 14mm blades, 45° angle
311-352	7" (177mm), 14mm blades, 60° angle
311-353	7" (176mm), 14mm blades, 90° angle
311-354	7" (176mm), 14mm blades, 125° angle

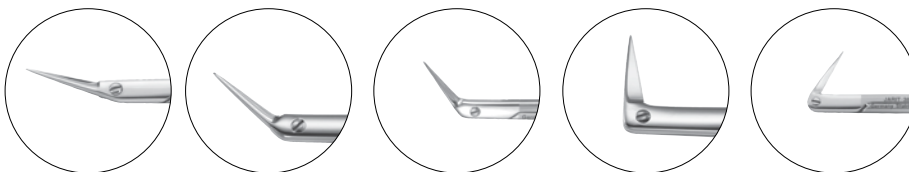

**Diethrich Coronary Artery Scissors, Supercut**

Catalog #	Description
102-350	7¼" (182mm), 25° angle, 12mm blades
102-351	7" (180mm), 45° angle, 13mm blades
102-352	7" (177mm), 60° angle, 13mm blades
102-353	6¾" (170mm), 90° angle, 13.5mm blades
102-354	6¾" (172mm), 125° angle, 11mm blades



**Diethrich Circumflex Artery Scissors, with Stabilizing Bar**

Catalog #	Description
310-360	6¾" (172mm), 130° angle, 13mm blades

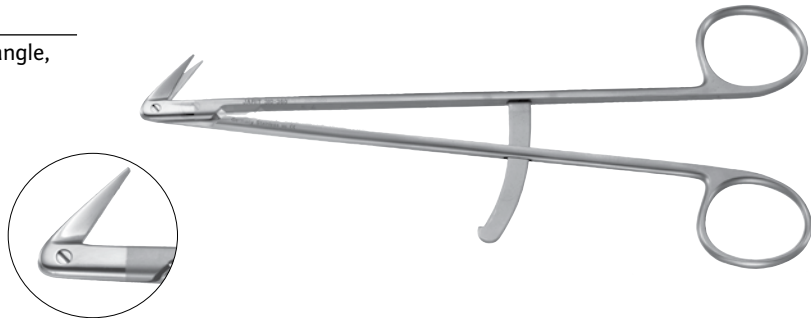

**Diethrich Circumflex Artery Scissors, with Stabilizing Bar, Supercut**

Catalog #	Description
102-360	6¾" (172mm), 130° angle, 13mm blades





### Diethrich-Potts Peripheral Vascular Scissors

Catalog #	Description
310-355	5 <sup>3</sup> / <sub>8</sub> " (138mm), 25° angle, 12mm blades
310-356	5 <sup>3</sup> / <sub>8</sub> " (138mm), 45° angle, 13mm blades
310-357	5 <sup>1</sup> / <sub>4</sub> " (133mm), 60° angle, 13mm blades
310-358	5" (126mm), 90° angle, 13.5mm blades

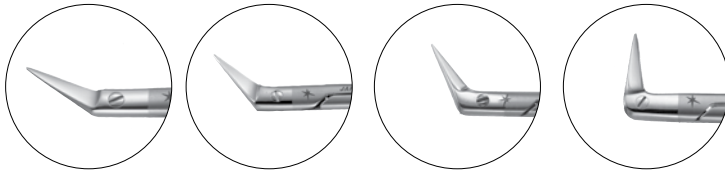

### Favaloro Coronary Artery Scissors

Catalog #	Description
310-374	6 <sup>3</sup> / <sub>4</sub> " (170mm), 130° angle, 9.5mm blades



### Favaloro Coronary Artery Scissors, Supercut

Catalog #	Description
102-374	6 <sup>1</sup> / <sub>4</sub> " (158mm), 125° angle, 9.5mm blades



### Karmody In-Situ Valve Scissors

Catalog #	Description
310-535	6" (152mm), working shaft, serrated blades, blunt tips

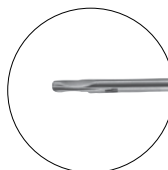

**Valve Leaflet Excision Scissors**

Catalog #	Description
310-540	4 <sup>3</sup> / <sub>8</sub> " (110mm), 45° angled on the flat



**Potts Finger Arteriotomy Scissors**

Catalog #	Description
310-542	5 <sup>3</sup> / <sub>8</sub> " (135mm), 45° angled to the flat

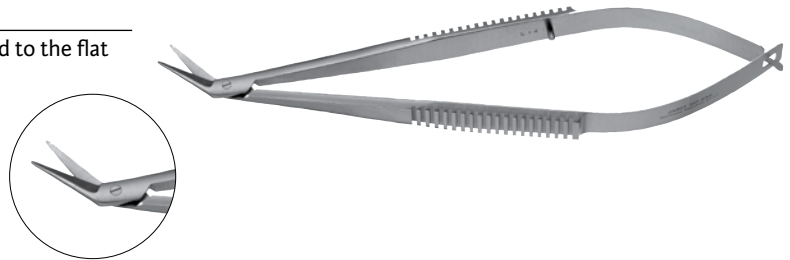

**Dennis Micro Scissors, Round Handle, Counter Balanced**

7<sup>1</sup>/<sub>4</sub>" (184mm), double action, 9mm micro blades

Catalog #	Description
277-058	Straight blades
277-059	Curved blades



**Jacobson Micro Scissors, Flat Handle**

Catalog #	Description
277-120	7" (180mm), straight, 15mm blades
277-121	7" (180mm), curved, 15mm blades
277-122	6 <sup>3</sup> / <sub>4</sub> " (172mm), angled to the side, 10mm blades

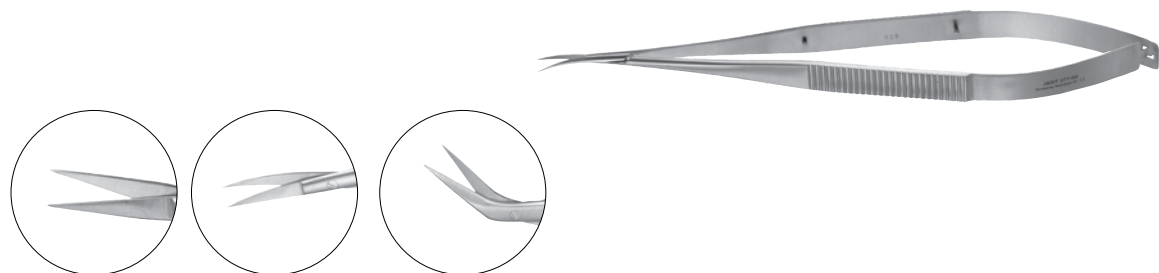

### Jacobson Micro Scissors, Flat Handle, Bayonet

Catalog #	Description
277-130	7¼" (185mm), straight, 13mm regular blades
277-131	7¼" (185mm), curved, 13mm regular blades
277-132	7¼" (185mm), angled on edge, 10mm regular blades
277-135	7¼" (185mm), straight, 11mm micro blades
277-136	7¼" (185mm), curved, 11mm micro blades

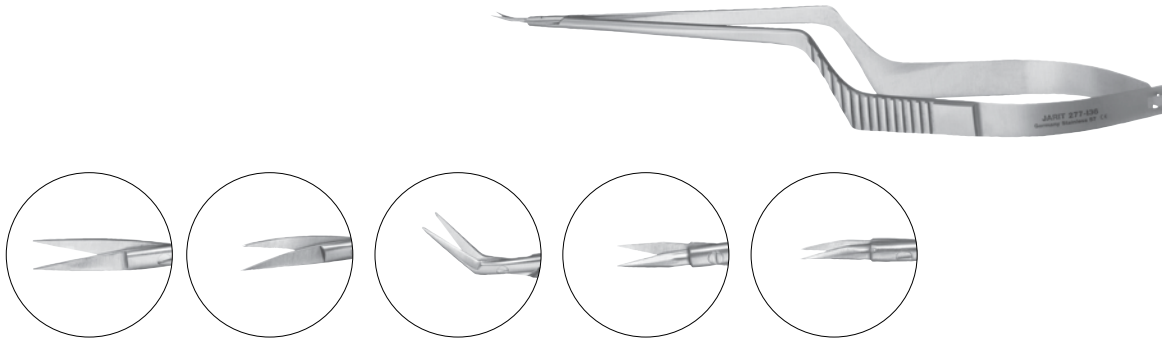

### Jacobson Micro Scissors, Round Handle

Micro Fine 9mm Blades

Catalog #	Description
277-335	6¾" (170mm), 25° angle
277-336	6¾" (170mm), 45° angle
277-337	6¾" (170mm), 60° angle
277-338	6½" (165mm), 90° angle
277-339	6½" (165mm), 120° angle

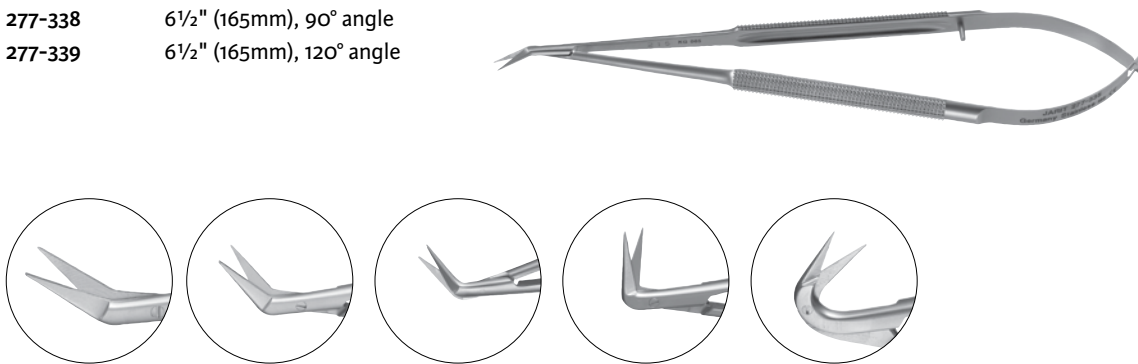

**Jacobson Micro Scissors, Flat Wide Handle**

micro fine 9mm blades

Catalog #	Description
277-330	6½" (165mm), 25° angle
277-331	6½" (165mm), 45° angle
277-332	6½" (165mm), 60° angle
277-333	6¼" (159mm), 90° angle
277-334	6¼" (159mm), 120° angle



**Jacobson Micro Scissors, Flat Handle**

7" (178mm), 12mm blades

Catalog #	Description
277-123	Straight blades, blunt tips
277-124	Curved blades, blunt tips

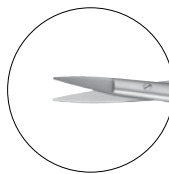

**Brolly-Adson Forceps, 1.2mm tips**

Catalog #	Description
130-246	6" (152mm), straight, serrated tips
130-247	6" (152mm), curved, serrated tips
130-248	6" (152mm), straight, Stardust tips
130-249	6" (152mm), straight, 1 x 2 teeth

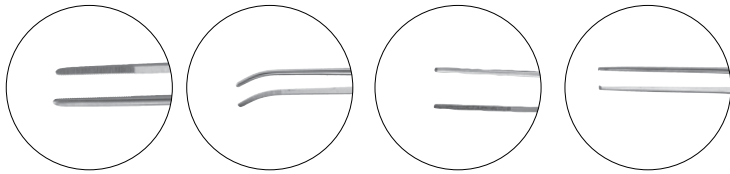

**Brown Tissue Forceps, double row of 8 x 8 teeth**

Catalog #	Description
130-265	6" (151mm)
130-266	8" (202mm)
130-267	10" (251mm)



**Nelson Tissue Forceps, 6 x 7 teeth**

Catalog #	Description
130-370	6" (151mm)
130-375	7" (178mm)
130-280	9" (228mm)



### Russian Tissue Forceps, (Mirror Finish)

Manufactured from high grade German surgical stainless steel which is ground and polished to a mirror finish

Catalog #	Description
130-390	5 <sup>7</sup> / <sub>8</sub> " (150mm)
130-392	7 <sup>3</sup> / <sub>4</sub> " (200mm)
130-395	10 <sup>1</sup> / <sub>4</sub> " (258mm)
130-394	12" (305mm)
130-396	14" (355mm)

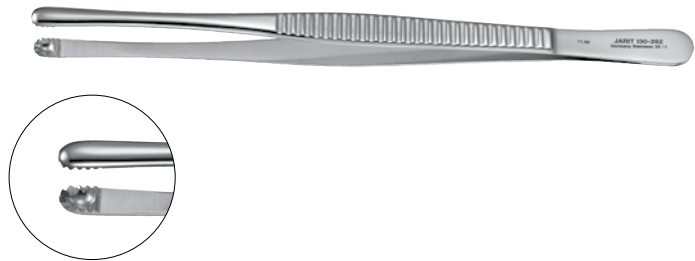

### Russian Tissue Forceps, (Matte Finish)

Manufactured from high grade German surgical stainless steel which is glass beaded to a matte finish

Catalog #	Description
129-390	5 <sup>7</sup> / <sub>8</sub> " (150mm)
129-392	7 <sup>3</sup> / <sub>4</sub> " (200mm)
129-395	10 <sup>1</sup> / <sub>4</sub> " (258mm)

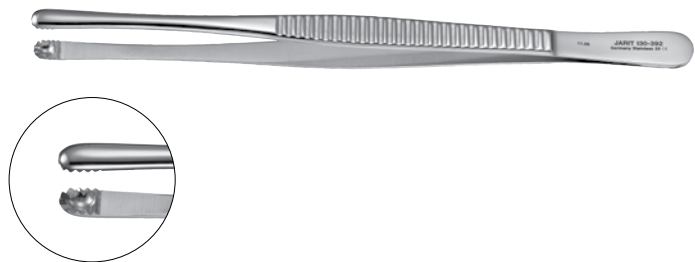

### Singley Tissue Forceps

Catalog #	Description
135-250	9" (229mm)
135-248	14" (356mm)



### Selman Tissue Forceps

3.8mm round cup with teeth

Catalog #	Description
135-252	6" (155mm)
135-253	8" (205mm)
135-254	9 <sup>3</sup> / <sub>4</sub> " (250mm)



**Wangensteen Tissue Forceps, Carb-Bite**

Catalog #	Description
135-256	6" (151mm)
135-257	9" (230mm)
135-258	10" (257mm)



**Mills Coronary Mammary Tissue Forceps**

Catalog #	Description
310-528	7" (180mm), ring tip (1.0mm OD x 0.5mm ID)



**Wheeler-Type Plaque and Vessel Forceps, Cardio-Grip™ Serrations**

Catalog #	Description
130-296	5 5/8" (142mm)
130-297	7 1/4" (182mm)
130-298	9" (226mm)



**Reul Coronary Tissue Forceps, Delicate, Carb-Bite**

Catalog #	Description
130-437	8" (206mm), 1.6mm wide x 12mm length jaw



**Potts-Smith Dressing Forceps, Serrated**

Catalog #	Description
130-350	7" (180mm)
130-355	8¼" (209mm)
130-360	9¾" (249mm)
130-367	10¼" (260mm)
130-365	11¾" (301mm)

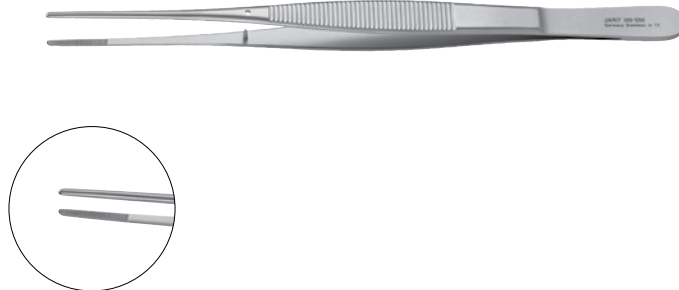

**Potts-Smith Tissue Forceps, 1 x 2 teeth**

Catalog #	Description
130-352	7¼" (184mm)
130-357	8¼" (210mm)
130-362	9¾" (249mm)
130-368	10¼" (260mm)
130-366	12" (305mm)



**Potts-Smith Tissue Forceps, Carb-Bite**

Catalog #	Description
130-353	7¼" (184mm)
130-358	8" (202mm)
130-363	9½" (241mm)
130-369	10¼" (261mm)



**Evans Tissue Forceps, Carb-Bite**

Catalog #	Description
130-383	9¾" (250mm)





**Cushing Dressing Forceps**

straight, serrated, scraper end

Catalog #	Description
130-400	6¾" (170mm), 1.5mm tip
130-445	7¾" (200mm), 2mm tip

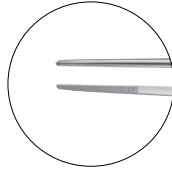

**Cushing Tissue Forceps**

straight, 1 x 2 teeth, scraper end

Catalog #	Description
130-405	6¾" (171mm), 1.5mm tip
130-446	7¾" (200mm), cross serrated, 2mm tip

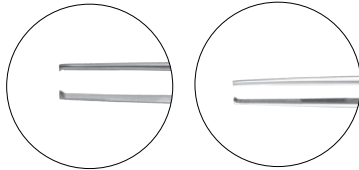

**Cushing Dressing Forceps**

bayonet, serrated, scraper end

Catalog #	Description
130-410	7¼" (183mm), 1.7mm tip
130-420	7¾" (200mm), 1.9mm tip

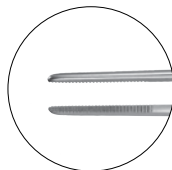

**Cushing Tissue Forceps**

bayonet, 1 x 2 teeth, scraper end

Catalog #	Description
130-415	7¼" (181mm), 1.7mm tip
130-421	7¾" (200mm), 1.7mm tip



**Cushing Dressing and Tissue Forceps**

Gutsch handle, straight, scraper end

Catalog #	Description
130-425	7" (178mm), serrated, 1.5mm wide tips
130-430	7" (178mm), 1 x 2 teeth, 1.5mm wide tips
130-435	7" (178mm), 1 x 2 teeth, serrated, 1.5mm wide tips

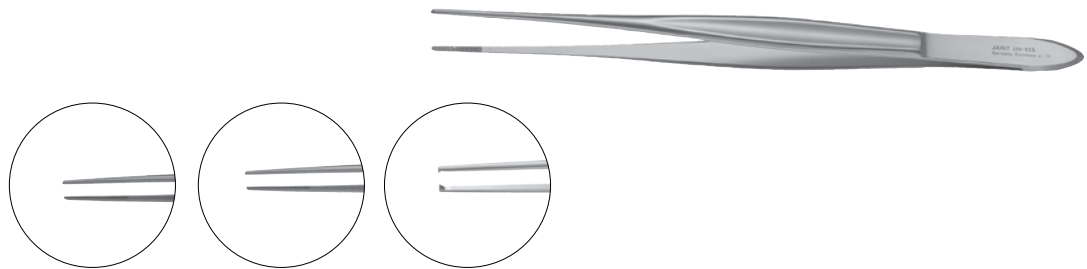

**Cushing Needle and Tissue Pulling Forceps, Carb-Bite**

straight, semi-sharp dissecting end, Gutsch handle

Catalog #	Description
122-530	7" (176mm), 1.8mm wide x 12mm length jaw, standard
122-535	7" (176mm), 1.6mm wide x 12mm length jaw, delicate



**Cushing Tissue Forceps, Carb-Bite**

square dissecting end, Gutsch handle

Catalog #	Description
130-417	7" (176mm), 1.8mm wide x 12mm length jaw, angled



**Cushing Dressing Forceps, Carb-Bite**

square dissecting end, bayonet

Catalog #	Description
130-418	7½" (191mm), 1.8mm wide x 14mm length jaw

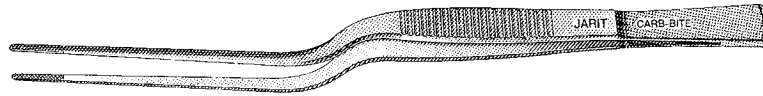

**Cushing-Brown Tissue Forceps**

double row of 9 x 9 delicate teeth, scraper end

Catalog #	Description
130-440	6¾" (174mm), straight

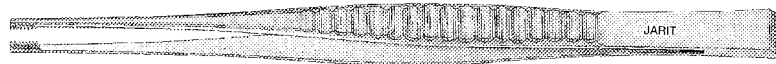

**Cushing-Brown Tissue Forceps**

bayonet, double row of 9 x 9 delicate teeth, scraper end

Catalog #	Description
130-442	7" (180mm)

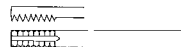

**Gerald Forceps, Cardio-Grip (DeBakey) Type Teeth**

straight, 1.2mm wide tips

Catalog #	Description
285-126	7" (180mm)
285-132	7¾" (200mm)
285-130	9½" (240mm)

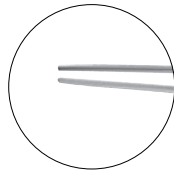

**Gerald Dressing Forceps**

straight, narrow, 1.3mm wide tips

Catalog #	Description
285-120	7" (175mm), serrated tips
285-128	9¼" (233mm), serrated tips
285-135	9¾" (250mm), cross-serrated tips

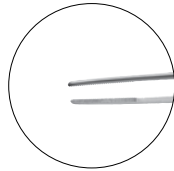

**Gerald Tissue Forceps**

straight, narrow, 1 x 2 teeth

Catalog #	Description
285-125	7" (176mm), 1.3mm wide tips
285-127	7½" (192mm), 1.4mm wide tips
285-129	9¼" (233mm), 1.4mm wide tips

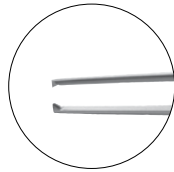

**Gerald Needle and Tissue Pulling Forceps, Carb-Bite**

straight, 1 x 2 teeth, 12mm length serrated tips

Catalog #	Description
122-570	7" (176mm), 1.2mm wide tips

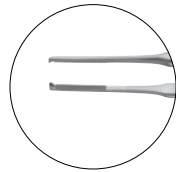

**Bonney Needle and Tissue Pulling Forceps, Carb-Bite**

straight, 1 x 2 teeth

Catalog #	Description
122-520	6 <sup>3</sup> / <sub>4</sub> " (173mm), 3.4mm wide tips

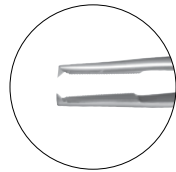

**DeBakey Needle and Tissue Pulling Forceps, Carb-Bite**

straight, 3 x 6 teeth, 2.0mm tips

Catalog #	Description
122-540	5 <sup>7</sup> / <sub>8</sub> " (150mm)
122-542	7 <sup>3</sup> / <sub>4</sub> " (197mm)
122-544	9 <sup>1</sup> / <sub>2</sub> " (240mm)

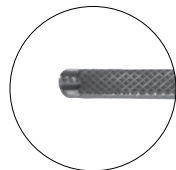

**DeBakey Needle and Tissue Pulling Forceps, Carb-Bite**

straight, 3 x 6 teeth, 1.5mm wide tips

Catalog #	Description
122-541	5 <sup>7</sup> / <sub>8</sub> " (150mm)
122-543	7 <sup>3</sup> / <sub>4</sub> " (197mm)
122-545	9 <sup>1</sup> / <sub>2</sub> " (240mm)

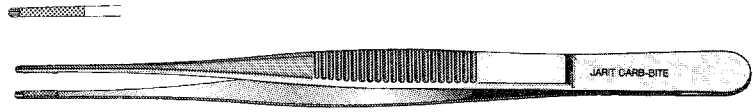

**Ferris-Smith Needle and Tissue Pulling Forceps, Carb-Bite**

1 x 2 teeth, 12.5mm length serrated tips

Catalog #	Description
122-550	6 <sup>3</sup> / <sub>4</sub> " (174mm), 3mm wide tips



**Semkin Needle and Tissue Pulling Forceps, Carb-Bite**

6" (153mm), 1 x 2 teeth, 12mm length serrated tips

Catalog #	Description
122-590	Standard, 1.7mm wide tips
122-591	Delicate, 1mm wide tips



**Skinner Needle and Tissue Pulling Forceps, Carb-Bite**

9¼" (232mm), 1 x 2 teeth, 8mm length serrated tips

Catalog #	Description
122-600	Standard, 4.5mm wide tips
122-601	Delicate, 2.6mm wide tips
122-602	Micro, 2mm wide tips



**DeBakey-Diethrich Vascular Tissue Forceps**

straight, extra delicate, 1mm tips

Catalog #	Description
320-050	6" (152mm), 20mm length serrated tips
320-051	7¾" (197mm), 20mm length serrated tips
320-052	9½" (241mm), 20mm length serrated tips

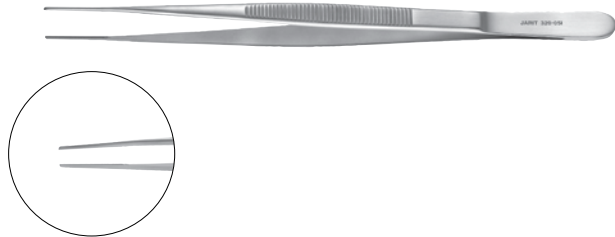

**DeBakey-Diethrich Coronary Artery Forceps**

straight, delicate, 1.5mm tips

Catalog #	Description
320-113	5⅞" (150mm), 24mm length serrated tips
320-114	7¾" (195mm), 24mm length serrated tips
320-115	9½" (240mm), 24mm length serrated tips
320-099	11¾" (300mm), 24mm length serrated tips



**DeBakey Vascular Tissue Forceps**

angled, standard, 2mm tips

Catalog #	Description
320-105	5⅞" (148mm), 21.5mm length serrated tips
320-106	7½" (192mm), 21.5mm length serrated tips
320-107	9¼" (237mm), 21.5mm length serrated tips

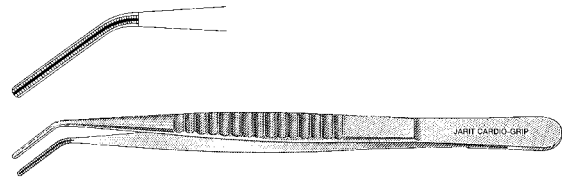

**DeBakey Vascular Tissue Forceps**

straight, standard, 2mm tips

Catalog #	Description
320-110	5⅞" (150mm), 24mm length serrated tips
320-111	7¾" (195mm), 24mm length serrated tips
320-112	9½" (240mm), 24mm length serrated tips
320-109	11¾" (300mm), 24mm length serrated tips
320-108	14¼" (360mm), 24mm length serrated tips





### DeBakey Thoracic Tissue Forceps

straight, heavy, 2.8mm tips

Catalog #	Description
320-100	5 <sup>7</sup> / <sub>8</sub> " (150mm), 24mm length serrated tips
320-101	7 <sup>3</sup> / <sub>4</sub> " (195mm), 24mm length serrated tips
320-102	9 <sup>1</sup> / <sub>2</sub> " (240mm), 24mm length serrated tips
320-103	11 <sup>3</sup> / <sub>4</sub> " (300mm), 24mm length serrated tips
320-104	14 <sup>1</sup> / <sub>4</sub> " (360mm), 24mm length serrated tips

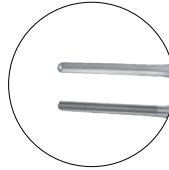

### DeBakey Thoracic Tissue Forceps

straight, extra heavy, 3.2mm tips

Catalog #	Description
320-070	5 <sup>7</sup> / <sub>8</sub> " (150mm), 24mm length serrated tips
320-071	7 <sup>3</sup> / <sub>4</sub> " (195mm), 24mm length serrated tips
320-072	9 <sup>1</sup> / <sub>2</sub> " (240mm), 24mm length serrated tips
320-073	11 <sup>3</sup> / <sub>4</sub> " (300mm), 24mm length serrated tips
320-074	14 <sup>1</sup> / <sub>4</sub> " (360mm), 24mm length serrated tips

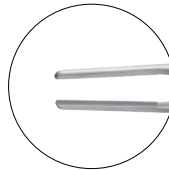

### Cooley Vascular Tissue Forceps

straight, standard, 2mm tips

Catalog #	Description
320-116	5 <sup>7</sup> / <sub>8</sub> " (150mm), 24mm length serrated tip
320-117	7 <sup>3</sup> / <sub>4</sub> " (195mm), 24mm length serrated tips
320-118	9 <sup>1</sup> / <sub>2</sub> " (240mm), 24mm length serrated tips

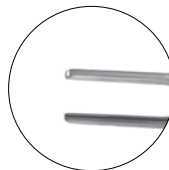

### Cooley Vascular Tissue Forceps

straight, delicate, 1.2mm cross-serrated tips

Catalog #	Description
320-119	7 <sup>3</sup> / <sub>4</sub> " (200mm), 1.2mm wide x 18mm length serrated tips

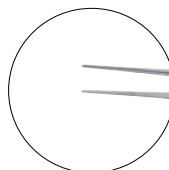

**Microsurgical Forceps with Platform**

7" (180mm) round handle

Catalog #	Description
277-040	Straight, 0.5mm micro tip
277-044	Curved, 0.5mm micro tip
277-042	Straight, 1mm micro tip
277-046	Curved, 1mm micro tip
277-041	Straight, 0.5mm 1 x 2 teeth
277-045	Curved, 0.5mm 1 x 2 teeth
277-043	Straight, 1mm 1 x 2 teeth
277-047	Curved, 1mm 1 x 2 teeth

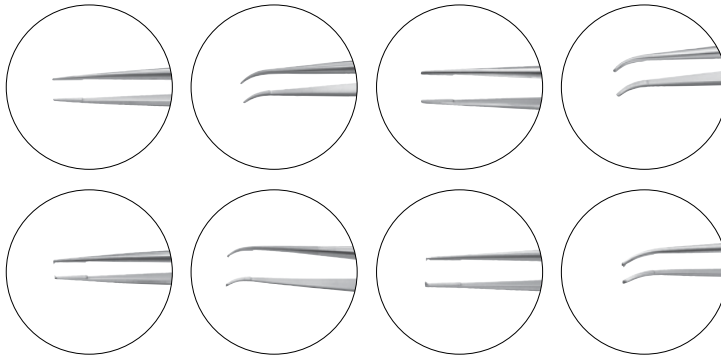

**Rhoton-Type Suture Tying Forceps, Round Handle with Platform Tips**

6mm platform

Catalog #	Description
277-049	7" (180mm), straight

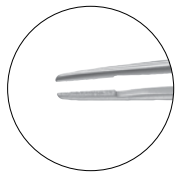

**Micro Suture Tying Forceps, Round Handle with Platform Tips**

6mm platform

Catalog #	Description
277-080	6" (152mm), straight
277-081	6" (152mm), curved

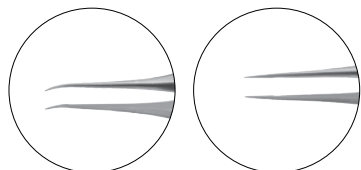

**Micro Forceps, Round Handle, Stardust**

straight, extra delicate, .8mm micro tips

Catalog #	Description
279-149	7¼" (181mm)



**Micro Forceps, Round Handle, Stardust**

straight, delicate, 1mm platform tips

Catalog #	Description
279-100	7¼" (184mm), straight
279-101	8¼" (210mm), straight
279-102	9" (229mm), straight



**Micro Forceps, Round Handle, Stardust**

curved, delicate, 1mm platform tips

Catalog #	Description
279-105	7¼" (184mm), straight
279-106	8¼" (210mm), straight
279-107	9" (229mm), straight



**Micro Forceps, Round Handle, Stardust**

straight, delicate, 1mm 1 x 2 teeth

Catalog #	Description
279-150	7¼" (181mm), straight



**Dennis Micro Forceps, Round Handle, Counter Balance**

delicate, 1mm Stardust platform tips

Catalog #	Description
279-158	7" (178mm), straight
279-159	7" (178mm), curved
279-125	8¼" (212mm), straight

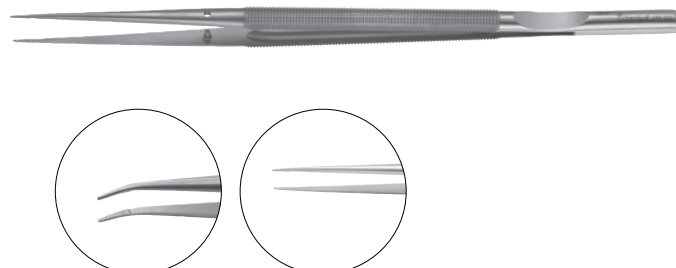

**Micro Ring Forceps, Stardust**

delicate, 1mm ring tips

Catalog #	Description
279-110	7¼" (184mm), straight
279-130	7¼" (181mm), curved
279-111	8¼" (210mm), straight
279-131	8¼" (210mm), curved
279-112	9" (229mm), straight

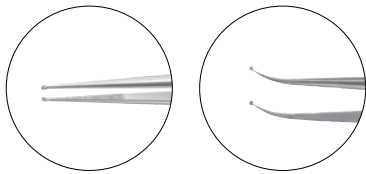

**Dennis Micro Ring Forceps, Round Handle, Counter Balance**

delicate, 1mm Stardust tips

Catalog #	Description
279-113	6" (152mm), straight
279-114	6" (152mm), curved
279-115	7¼" (186mm), straight
279-116	7¼" (186mm), curved
279-117	8¼" (209mm), straight
279-118	8¼" (209mm), curved
279-119	9" (230mm), straight
279-120	9" (230mm), curved
279-121	10" (254mm), straight
279-122	10" (254mm), curved

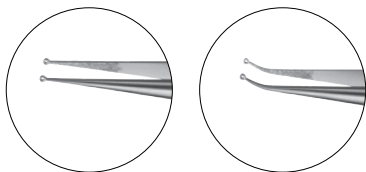

### Pennington Tissue Forceps

Catalog #	Description
305-200	8¼" (212mm), jaw width 10mm

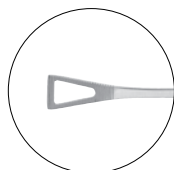

### Collins Tissue Forceps

Catalog #	Description
305-205	9" (229mm), jaw width 25mm

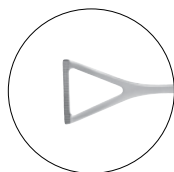

### Duval Lung Forceps

Catalog #	Description
305-210	8" (205mm), jaw width 28mm
305-215	9" (228mm), jaw width 28mm

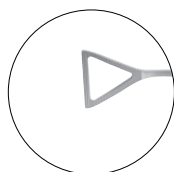

### Lovelace Lung Forceps

Catalog #	Description
305-220	7¼" (186mm), jaw width 28mm

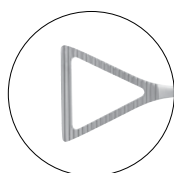

**Allis-Willauer Tissue Forceps**

5 x 6 teeth

Catalog #	Description
305-230	10" (255mm), jaw width 6.5mm
305-231	11" (282mm), jaw width 5.7mm
305-233	13¾" (350mm), jaw width 5.7mm

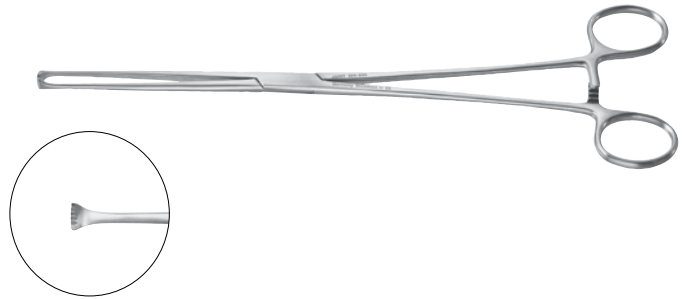

**Kantrowitz Thoracic Forceps**

Catalog #	Description
305-294	6" (152mm)
305-295	7¾" (195mm)
305-296	9½" (240mm)
305-297	10¾" (272mm)



**Petit-Point Jacobson Mosquito Forceps, very delicate**

Catalog #	Description
105-092	7¼" (185mm), slightly curved
105-093	7¼" (185mm), fully curved

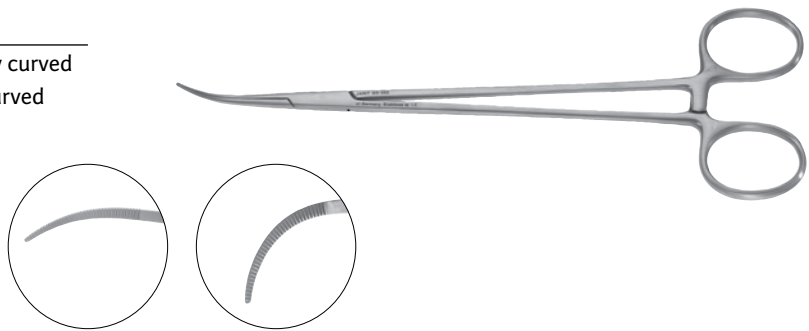

**Ochsner Forceps, Very Fine Serrated Jaws**

Catalog #	Description
105-235	4⅝" (116mm), 90 degree angle

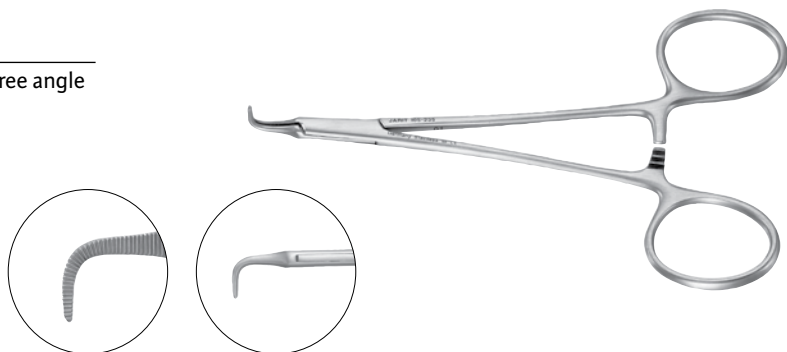

### Bainbridge Forceps, Longitudinal Serrations

Catalog #	Description
105-300	5 <sup>7</sup> / <sub>8</sub> " (150mm), 40mm length jaws
105-302	5 <sup>7</sup> / <sub>8</sub> " (150mm), 40mm length jaws
105-304	7 <sup>1</sup> / <sub>4</sub> " (185mm), 60mm length jaws
105-306	7 <sup>1</sup> / <sub>4</sub> " (185mm), 60mm length jaws



### Bainbridge Forceps, DeBakey serrations

Catalog #	Description
320-228	8" (203mm), straight, delicate, 63mm jaws
320-229	8" (203mm), curved, delicate, 61mm jaws



### Diethrich Right Angle Clamps

Catalog #	Description
140-232	4 <sup>7</sup> / <sub>8</sub> " (124mm)
140-233	5 <sup>3</sup> / <sub>8</sub> " (138mm)
340-234	7" (180mm)

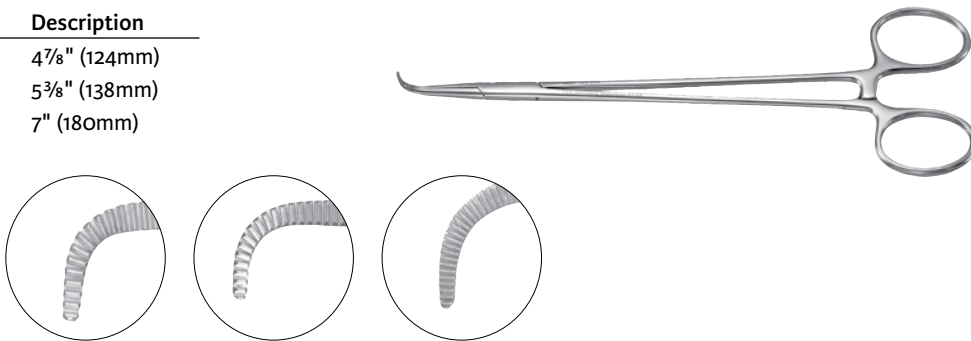

### Gemini Artery Clamps

Catalog #	Description
140-329	5 <sup>3</sup> / <sub>8</sub> " (137mm)
140-330	7 <sup>1</sup> / <sub>2</sub> " (190mm)
140-331	8" (205mm)
140-332	9" (230mm)
140-333	11" (280mm)
140-335	14 <sup>1</sup> / <sub>4</sub> " (360mm)



**Coller Artery Forceps, Full Horizontal Serrations**

Catalog #	Description
105-330	Slight curve, 9¼" (238mm)
105-331	Strong curve, 9¼" (234mm)
105-332	Right angle, 8¾" (225mm)

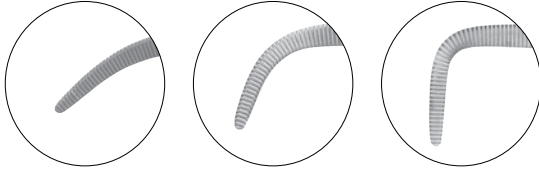

**Storey Artery Forceps, Cross Serrations**

Catalog #	Description
105-340	Slight curve, 8¾" (225mm)
105-341	Strong curve, 8¾" (225mm)
105-342	Right angle, 8½" (214mm)

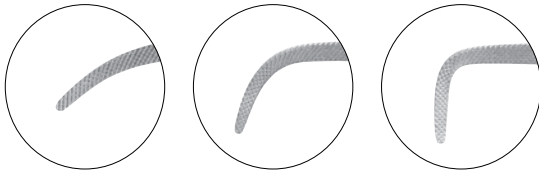

**Meeker Artery Clamp**

Catalog #	Description
140-231	7¼" (181mm)
305-300	10¾" (275mm)



**Lawrence Forceps**

Catalog #	Description
305-305	7¼" (187mm)
305-306	11" (280mm)

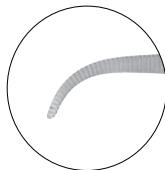



**Bridge Deep Surgery Forceps**

Catalog #	Description
305-308	Curved, 7½" (191mm)
305-309	Straight, 11" (279mm)
305-310	Curved, 11" (279mm)

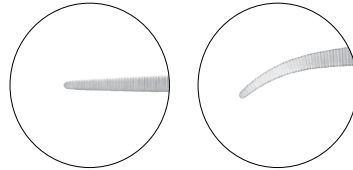

**Julian Thoracic Artery Forceps**

Catalog #	Description
305-320	9½" (240mm), slightly curved

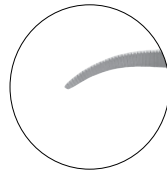

**Woodward Thoracic Artery Forceps**

Catalog #	Description
305-325	8¾" (220mm), slightly curved

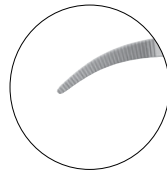

**Thoracic Mosquito Forceps**

Catalog #	Description
305-330	7¼" (184mm)
305-332	7¼" (185mm)
305-337	9¼" (232mm)



**Heiss Artery Forceps**

8" (205mm)

Catalog #	Description
305-350	Straight
305-351	Half curved
305-352	Full curved

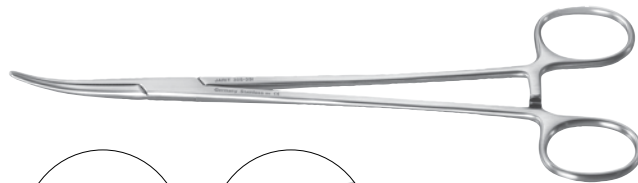
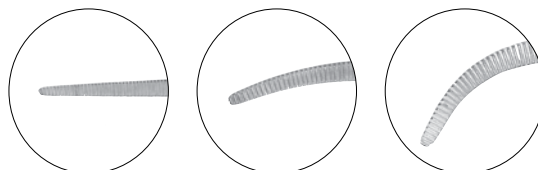

**Vanderbilt University Deep Vessel Clamp**

Catalog #	Description
305-355	9" (228mm)

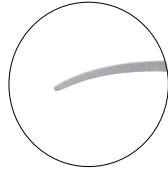

**Bengolea Forceps**

Catalog #	Description
305-359	8½" (215mm)

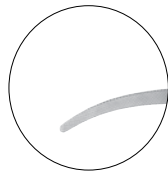

**Crafoord (Coller) Artery Forceps**

Catalog #	Description
305-360	7½" (191mm)
305-362	9¾" (248mm)

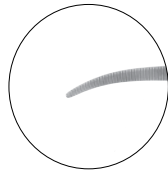

**Sarot Artery Forceps**

Catalog #	Description
305-363	7¾" (195mm)
305-365	9¾" (248mm)
305-366	13¾" (350mm)

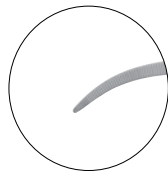

**DeBakey-Collier Artery Forceps**

Catalog #	Description
305-367	8" (202mm)
305-368	10" (253mm)
305-369	14" (356mm)

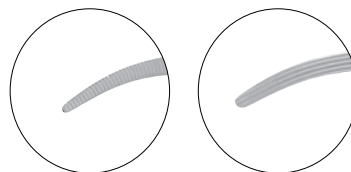

### Lahey Gall Duct Forceps

Catalog #	Description
140-205	7½" (191mm)
140-206	7¾" (195mm), delicate
140-228	7½" (190mm), cross serrated tips

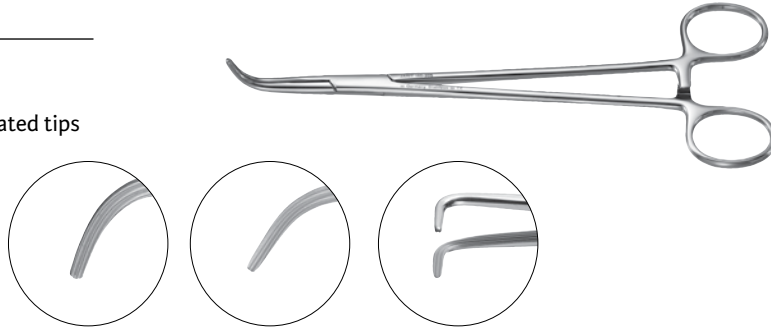

### Lahey Thoracic Forceps

Catalog #	Description
305-370	9" (226mm), full curved
305-372	9" (228mm), full curved, delicate
305-373	8½" (216mm), 90° angle, delicate

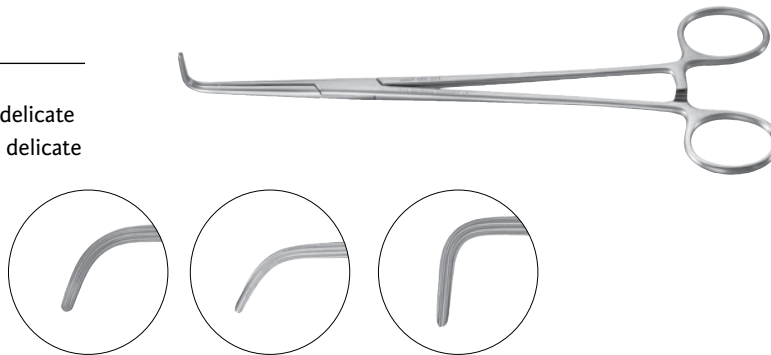

### Mixer Forceps, Pediatric

Catalog #	Description
140-216	5¾" (138mm), curved
140-217	5" (127mm), right angle

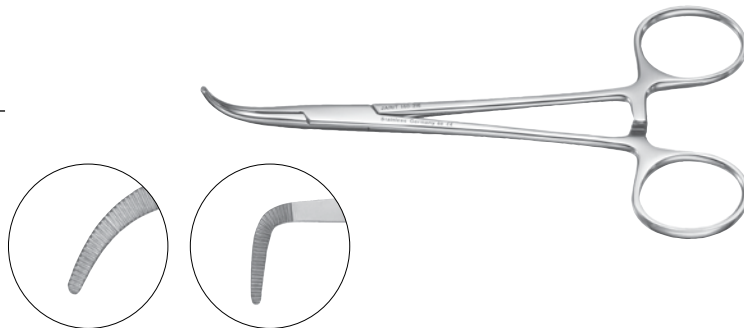

### Petit-Point Mixer Forceps

right angle

Catalog #	Description
140-218	5¾" (137mm), partial jaw serrations

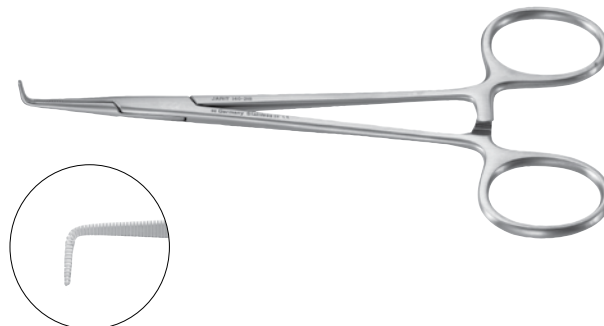

**Petit-Point Mixer Forceps**

right angle

Catalog #	Description
140-223	7¼" (185mm), full jaw serrations

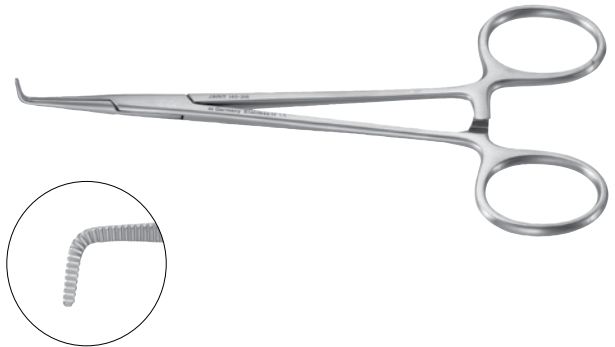

**Mixer Forceps, Full Horizontal Serrations**

Catalog #	Description
140-224	6¼" (160mm)
140-225	7" (175mm)

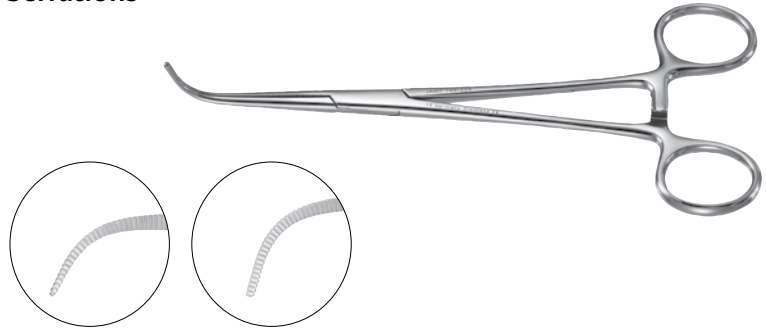

**Mixer Forceps, Partial Horizontal Serrations**

Catalog #	Description
140-226	8¾" (224mm)
140-230	9¼" (232mm)

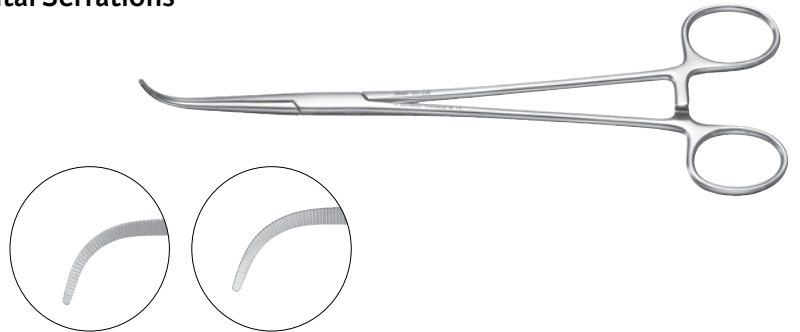

**Mixer Forceps, Longitudinal Serrations**

Catalog #	Description
305-380	10¾" (274mm), full curved



### Mixer Forceps

11" (280mm), delicate

Catalog #	Description
305-385	Horizontal serrations
305-386	Longitudinal serrations with cross serrated tips

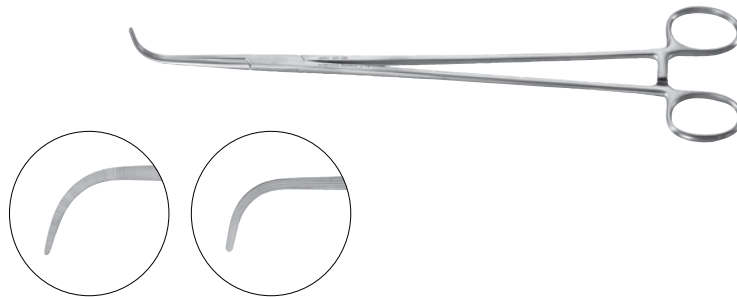

### Mixer Forceps, Longitudinal Serrations

delicate, cross serrated tips

Catalog #	Description
305-388	8¾" (220mm)
305-389	10¼" (260mm)

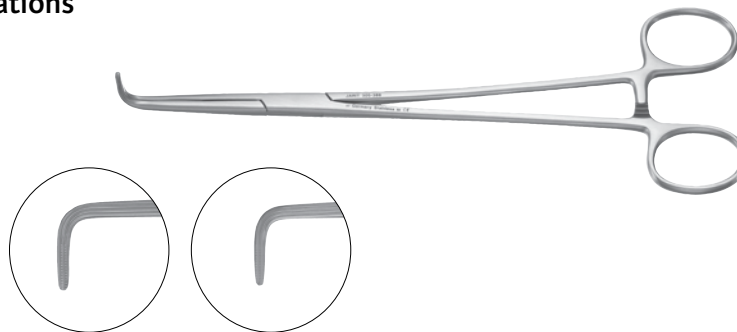

### Harrington Mixer Forceps, Longitudinal Serrations

right angle

Catalog #	Description
305-390	12" (305mm), heavy pattern
305-395	12¼" (311mm), light pattern
305-396	14¼" (360mm), light pattern

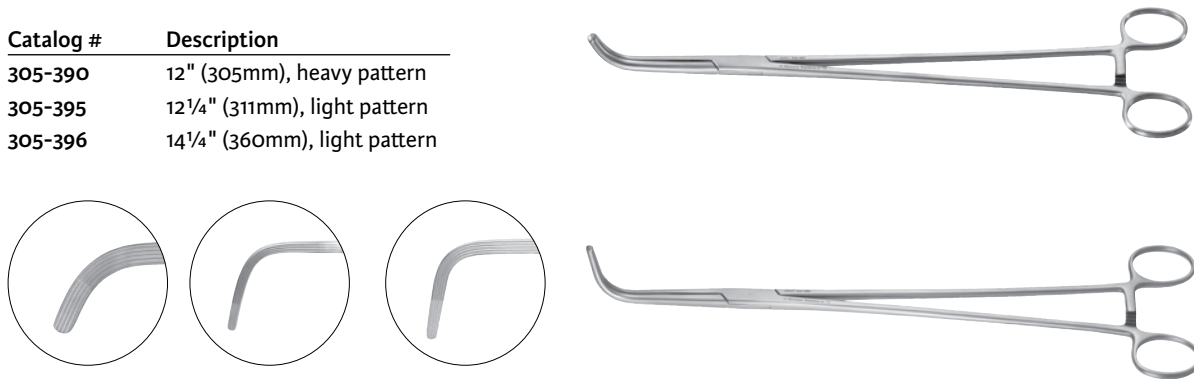

### Carmalt Forceps, Cross-Serrated Tips

Catalog #	Description
305-397	12¼" (313mm), jaw length 2¾" (71mm)



**Rochester-Pean Forceps**

Catalog #	Description
305-398	11¾" (300mm), jaw length 3⅞" (99mm)
305-399	14" (354mm), jaw length 4⅜" (111mm)

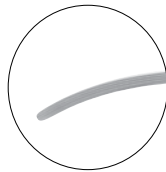

**Rummel Thoracic Artery Forceps**

Catalog #	Description
305-400	"A" curve, 9½" (240mm)
305-401	"B" curve, 9½" (240mm)
305-402	"C" curve, 9¼" (235mm)
305-403	"D" curve, 9" (230mm)

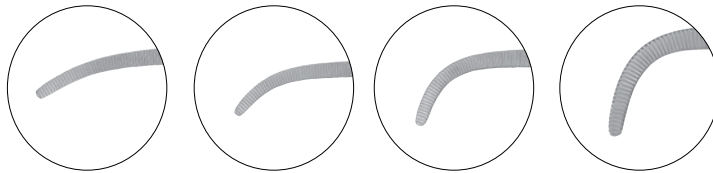

**DeBakey Thoracic Dissecting Forceps, Cardio-Grip**

Catalog #	Description
305-405	8" (203mm), "C" curve
305-406	8" (203mm), "D" curve
305-407	8½" (216mm), "C" curve
305-408	8½" (216mm), "D" curve

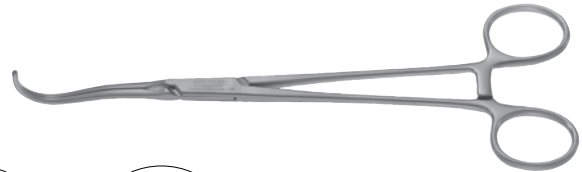
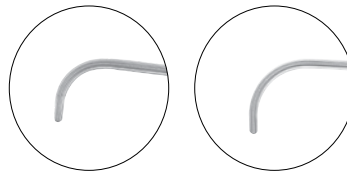

**Jones Thoracic Clamp**

Catalog #	Description
305-431	9" (229mm)

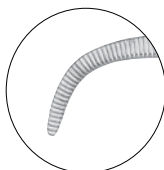

### Semb Ligature Carrier

Catalog #	Description
305-441	9½" (240mm)



### DeBakey-Semb Ligature Carrier

Catalog #	Description
320-274	11" (280mm), jaw working length 3" (75mm), length of serrations ¾" (20mm)

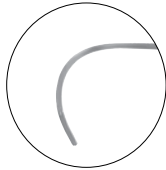

### Sarot Bronchus Clamps

8¾" (225mm), total jaw length 2¾" (60mm), jaw working length 1¾" (35mm)

Catalog #	Description
305-450	Right
305-451	Left

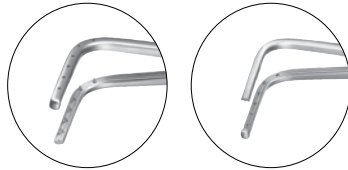

### Rummel Tourniquets

Catalog #	Description
305-500	Adult size, 12" (307mm)
305-501	Child size, 8¼" (209mm)
305-498	Obturator only, adult size (Crochet Hook), 11" (280mm)
305-499	Obturator only, child size (Crochet Hook), 8½" (215mm)

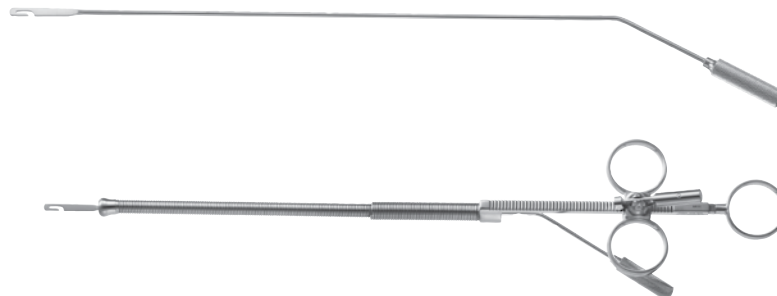

**Webster Needle Holders, Carb-Bite**

3600 teeth per square inch, for use with 5.0 and 6.0 suture

Catalog #	Description
121-119	4 <sup>5</sup> / <sub>8</sub> " (118mm), serrated jaws
121-118	4 <sup>5</sup> / <sub>8</sub> " (118mm), smooth jaws



**Fell Needle Holders, Carb-Bite**

4000 teeth per square inch, for use with 2.0, 3.0 and 4.0 suture

Catalog #	Description
121-270	5 <sup>1</sup> / <sub>4</sub> " (132mm), 1.8mm wide x 13mm length jaws
121-271	6 <sup>1</sup> / <sub>4</sub> " (159mm), 2mm wide x 13mm length jaws
121-272	7" (178mm), 2mm wide x 14mm length jaws
121-273	8" (203mm), 2mm wide x 15mm length jaws
121-274	9" (227mm), 1.9mm wide x 16mm length jaws

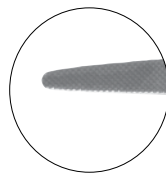

**Crile-Wood Needle Holders, Carb-Bite**

4000 teeth per square inch, for use with 4.0, 5.0 and 6.0 suture  
curved jaw

Catalog #	Description
121-126	7 <sup>1</sup> / <sub>2</sub> " (188mm)
121-127	9 <sup>1</sup> / <sub>4</sub> " (232mm)

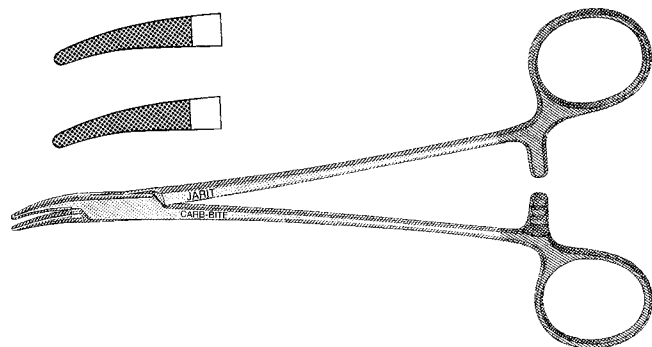
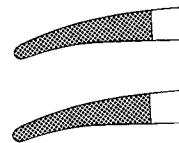

INCHES  
MILLIMETERS



**Crile-Wood Needle Holders, Carb-Bite, (Satin Finish)**

4000 teeth per square inch, for use with 4.0, 5.0 and 6.0 suture  
Manufactured from high grade German surgical stainless steel which is ground and polished to a satin finish

Catalog #	Description
121-130	6" (152mm)
121-131	7" (180mm)
121-132	8" (205mm)
121-133	9" (231mm)
121-134	10½" (267mm)
121-129	12¼" (311mm)
121-128	14" (356mm)



**Crile-Wood Needle Holders, Carb-Bite, (Matte Finish)**

4000 teeth per square inch, for use with 4.0, 5.0 and 6.0 suture  
Manufactured from high grade German surgical stainless steel which is glass beaded to a matte finish

Catalog #	Description
123-130	6" (152mm)
123-131	7" (180mm)
123-132	8" (205mm)



**Mayo-Hegar Needle Holders, Carb-Bite, (Satin Finish)**

2500 teeth per square inch, for use with 1.0, 2.0, 3.0 and 4.0 suture  
Manufactured from high grade German surgical stainless steel which is ground and polished to a satin finish

Catalog #	Description
121-135	6¼" (160mm)
121-140	7¼" (187mm)
121-145	8" (206mm)
121-146	9½" (240mm)
121-142	10¾" (263mm)
121-143	11" (280mm)
121-147	11¾" (300mm)
121-144	13¾" (350mm)

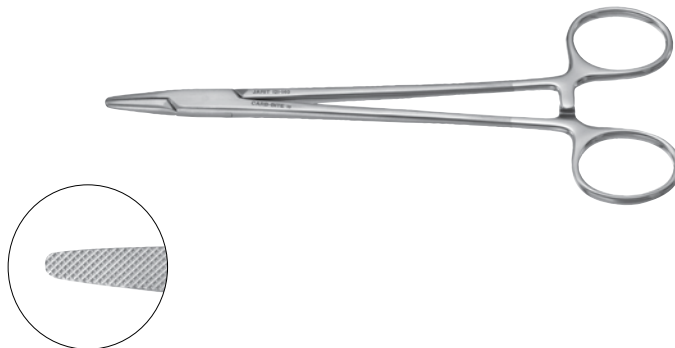

**Mayo-Hegar Needle Holder, Carb-Bite, (Matte Finish)**

2500 teeth per square inch, for use with 1.0, 2.0, 3.0 and 4.0 suture

Manufactured from high grade German surgical stainless steel which is glass beaded to a matte finish

Catalog #	Description
123-135	6 1/4" (160mm)
123-140	7 1/4" (187mm)
123-145	8" (206mm)

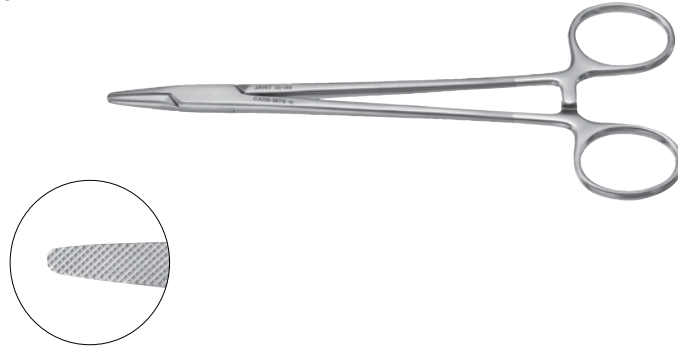

**Ryder Needle Holders, Carb-Bite**

4000 teeth per square inch, for use with 4.0, 5.0 and 6.0 suture

Catalog #	Description
121-160	5" (126mm)
121-161	5 7/8" (149mm)
121-162	7 1/4" (184mm)
121-163	8" (202mm)
121-164	9" (230mm)
121-165	10 1/4" (262mm)

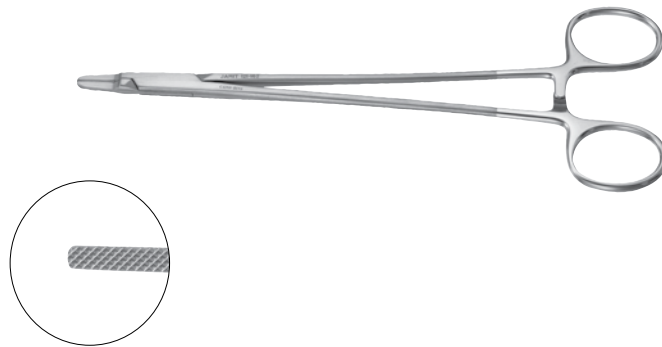

**Petit-Point Ryder Needle Holders, Carb-Bite**

7000 teeth per square inch, for use with 4.0, 5.0 and 6.0 suture  
serrated jaws

Catalog #	Description
121-170	4 7/8" (124mm)
121-172	6 1/4" (156mm)
121-174	7" (176mm)
121-176	7 3/4" (200mm)
121-177	9" (228mm)

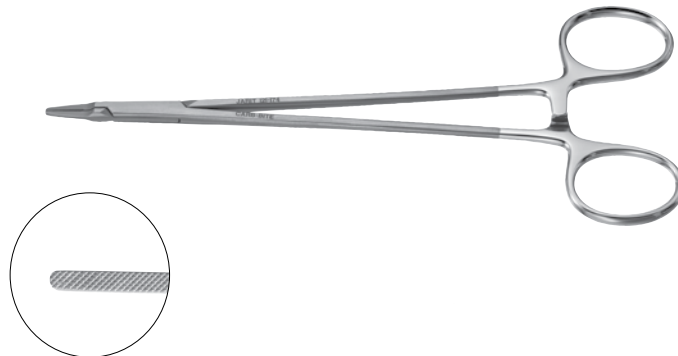

**Petit-Point Ryder Needle Holders, Carb-Bite**

smooth jaws, for use with 4.0, 5.0 and 6.0 suture

Catalog #	Description
121-171	4 <sup>7</sup> / <sub>8</sub> " (124mm)
121-173	6 <sup>1</sup> / <sub>4</sub> " (156mm)
121-175	7" (176mm)
121-179	7 <sup>3</sup> / <sub>4</sub> " (200mm)
121-178	9" (228mm)

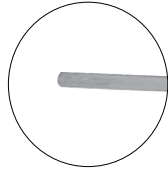

**Hufnagel-Ryder Needle Holder, Carb-Bite**

4000 teeth per square inch, for use with 4.0, 5.0 and 6.0 suture

Catalog #	Description
121-166	8 <sup>3</sup> / <sub>4</sub> " (225mm)

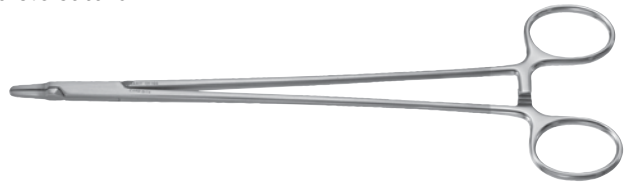
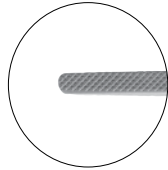

**Cooley Intracardiac Needle Holders, Carb-Bite**

4000 teeth per square inch, for use with 2.0, 3.0 and 4.0 suture

Catalog #	Description
121-216	7" (179mm)
121-217	8" (202mm)
121-218	9" (229mm)
121-219	10 <sup>1</sup> / <sub>4</sub> " (261mm)

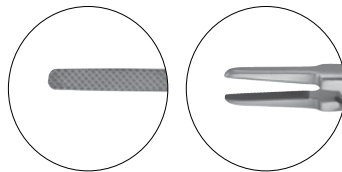

**Masson Needle Holder, Carb-Bite**

2500 teeth per square inch, for use with 1.0, 2.0, 3.0 and 4.0 suture

Catalog #	Description
121-180	10 <sup>1</sup> / <sub>2</sub> " (268mm)

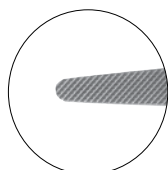

**Diethrich Microvascular Needle Holders, Carb-Bite**

7000 teeth per square inch, for use with 6.0 and 7.0 suture

Catalog #	Description
121-181	7" (180mm)
121-182	7¾" (200mm)
121-183	9" (230mm)

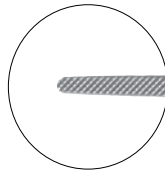

**DeBakey Vascular Needle Holders, Carb-Bite**

7000 teeth per square inch, for use with 5.0, 6.0 and 7.0 suture

Catalog #	Description
121-184	5⅞" (150mm)
121-185	7" (178mm)
121-186	8" (205mm)
121-187	9" (230mm)
121-188	10¼" (260mm)
121-189	12¼" (311mm)

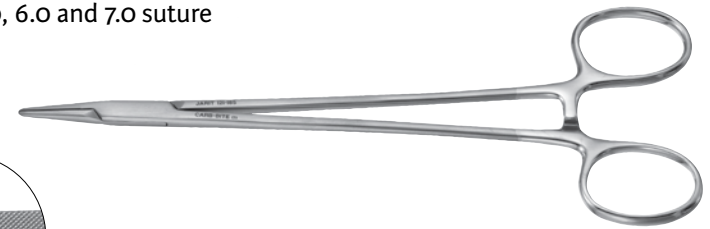
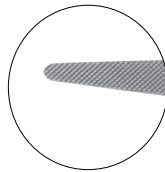

**Finochietto Needle Holder, Carb-Bite**

2500 teeth per square inch, for use with 2.0, 3.0 and 4.0 suture

Catalog #	Description
121-192	10¼" (262mm)

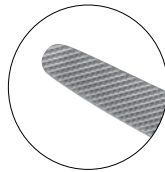

**DeBakey Needle Holder, Carb-Bite**

4000 teeth per square inch, for use with 4.0, 5.0 and 6.0 suture

Catalog #	Description
121-193	9" (230mm)

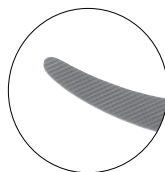

**Stratte Valve Needle Holders, Carb-Bite**

2500 teeth per square inch, for use with 2.0, 3.0 and 4.0 suture

Catalog #	Description
121-195	9" (227mm), double curved
121-196	10" (254mm), double curved, delicate tip

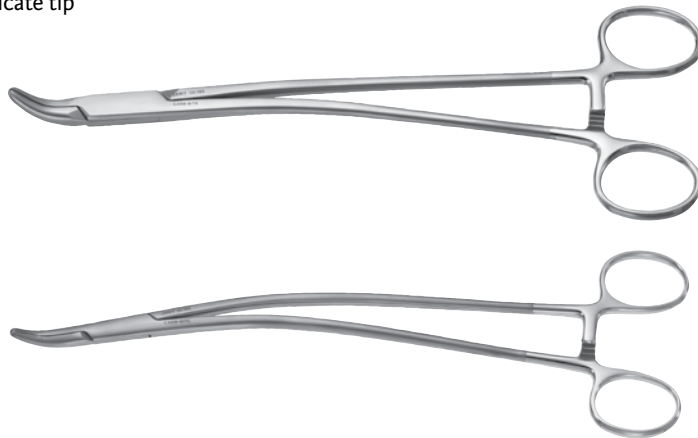
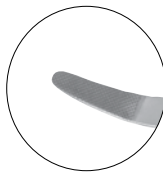
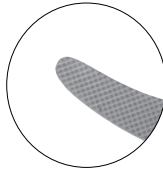

**Petit-Point Sarot Needle Holders, Carb-Bite**

4000 teeth per square inch, for use with 5.0 and 6.0 suture

Catalog #	Description
121-197	5 7/8" (150mm), delicate
121-198	6 3/4" (169mm), delicate

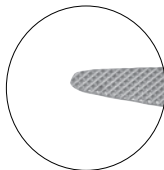

**Sarot Needle Holders, Carb-Bite**

2500 teeth per square inch, for use with 4.0, 5.0 and 6.0 suture

Catalog #	Description
121-200	7 1/4" (182mm)
121-205	10 1/4" (258mm)

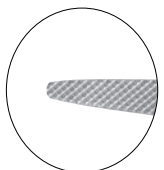

**Julian Needle Holders, Carb-Bite**

4000 teeth per square inch, for use with 4.0, 5.0 and 6.0 suture

Catalog #	Description
121-206	8¼" (210mm), straight
121-207	8¼" (210mm), curved

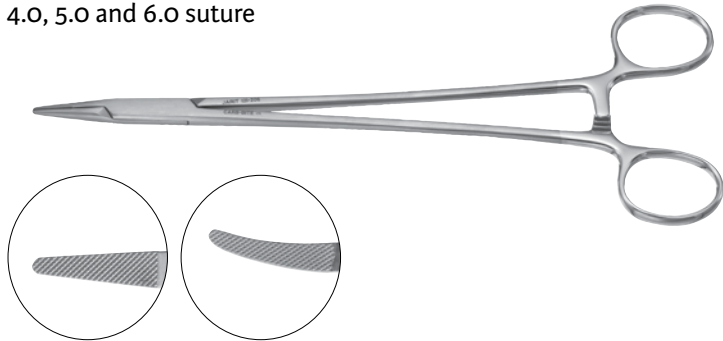

**Microvascular Needle Holders, Carb-Bite**

4000 teeth per square inch, for use with 4.0, 5.0 and 6.0 suture

Catalog #	Description
121-211	6" (152mm)
121-212	7¼" (184mm)
121-213	8" (203mm)
121-214	9" (228mm)
121-215	10½" (267mm)

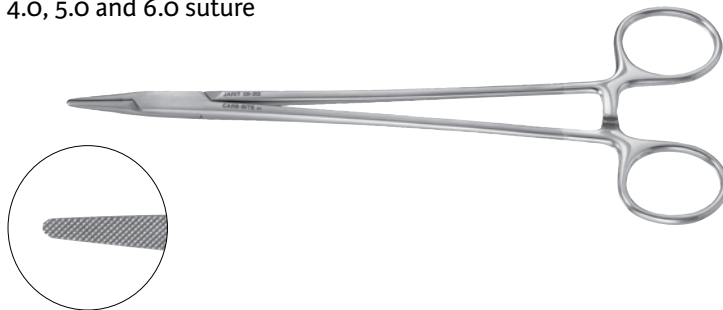

**Micro Needle Holders, Stardust**

straight, 1.6mm tips, for use with 5.0 and 6.0 suture

Catalog #	Description
277-400	5" (127mm)
277-402	5¾" (146mm)
277-404	6¼" (160mm)
277-407	7½" (190mm)
277-410	7½" (190mm), left handed
277-411	8¾" (225mm)
277-414	9¾" (250mm)

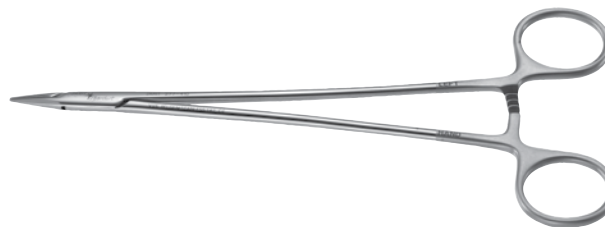

**Micro Needle Holders, Stardust**

curved, 1mm tips, for use with 5.0 and 6.0 suture

Catalog #	Description
277-401	5" (127mm)
277-403	5¾" (146mm)
277-406	6¼" (160mm)
277-409	7½" (190mm)
277-413	8¾" (225mm)
277-415	9¾" (250mm)



**"Low Ryder" Needle Holders, Stardust**

straight, 2mm tips, for use with 5.0, 6.0 and 7.0 suture

Catalog #	Description
277-405	6¼" (160mm)
277-408	7½" (190mm)
277-412	8¾" (225mm)

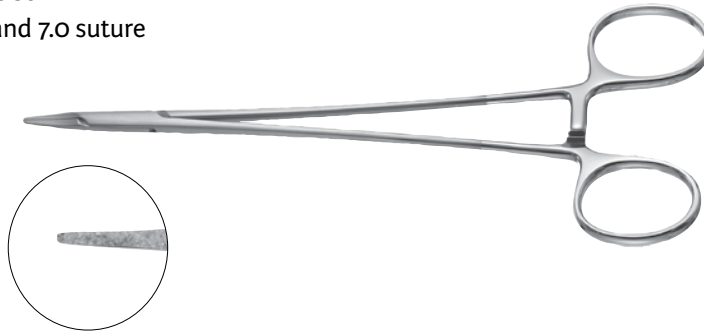

**Castroviejo Style Microsurgical Needle Holders, Carb-Bite**

1mm tips, for use with 5.0, 6.0 and 7.0 suture  
serrated jaws

Catalog #	Description
121-229	7" (178mm)
121-229NL	7" (178mm) (Non Locking)
121-231	8½" (216mm)
121-231NL	8½" (216mm) (Non Locking)



**Castroviejo Style Microsurgical Needle Holders, Carb-Bite**

1mm tips, for use with 5.0, 6.0 and 7.0 suture  
smooth jaws

Catalog #	Description
121-228	7" (178mm)
121-228NL	7" (178mm) (Non Locking)
121-230	8½" (216mm)
121-230NL	8½" (216mm) (Non Locking)

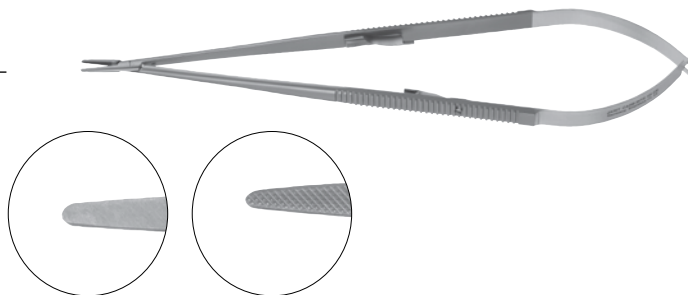

**Rubio Sternal Needle Holder and Wire Twister, Carb-Bite**

4000 teeth per square inch, for use with 1.0 and 2.0 suture

Catalog #	Description
121-250	5¼" (132mm)



**Sternal Needle Holder and Wire Twister, Carb-Bite**

4000 teeth per square inch, for use with 1.0 and 2.0 suture

Catalog #	Description
121-255	7" (176mm)

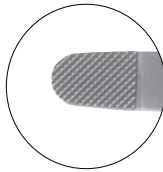

**Wire Twisters, Carb-Bite**

2500 teeth per square inch, for use with 1.0 and 2.0 suture

Catalog #	Description
121-257	6" (155mm), short delicate jaws
121-258	6" (155mm), short blunt jaws

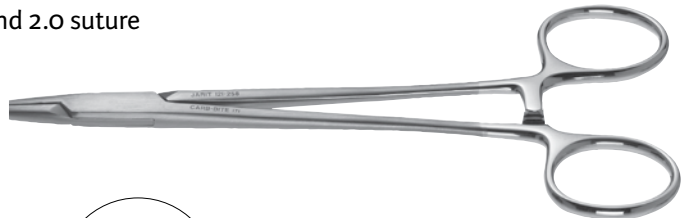
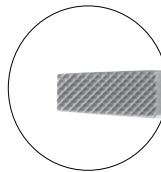
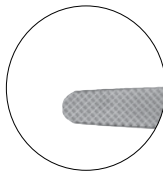

**Berry Sternal Needle Holder and Wire Twister, Carb-Bite**

1800 teeth per square inch, for use with 1.0 and 2.0 suture

Catalog #	Description
121-260	7 1/4" (186mm), heavy duty 5mm blunt jaws

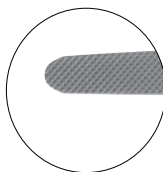

**Cooley-Baumgarten, Sternal Wire Twister, Carb-Bite**

2500 teeth per square inch, for use with 1.0 and 2.0 suture

Catalog #	Description
121-265	8" (205mm), heavy duty, square 5mm blunt jaws

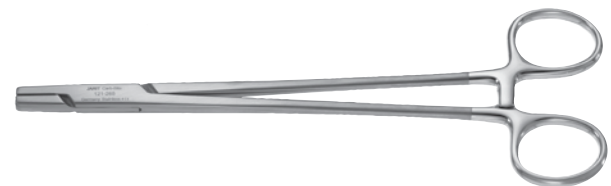
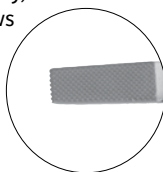



### Cooley Graft Suction Tube

Catalog #	Description
310-103	14" (357mm), 8mm wide tip

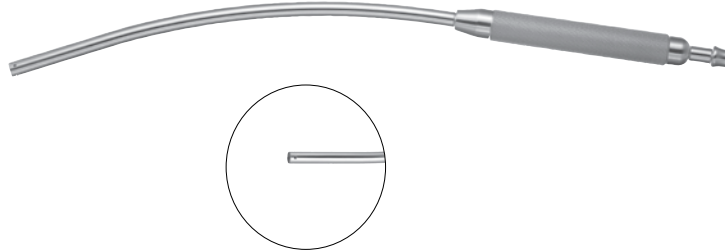

### Cooley Vascular Suction Tube

Catalog #	Description
310-105	12" (307mm), 6mm wide tip
310-TIP-105	Replacement Tip pkg/12ea

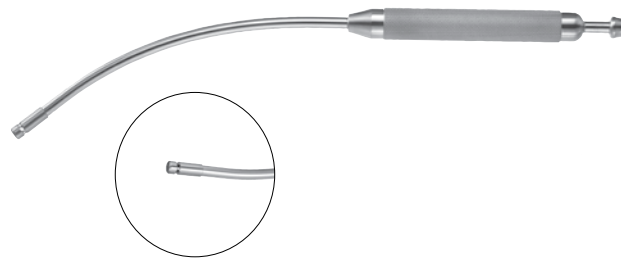

### Cooley Intracardiac Suction Tube

Catalog #	Description
310-108	12 1/4" (309mm), detachable 10mm tip
310-TIP-108	Replacement Tip pkg/12ea

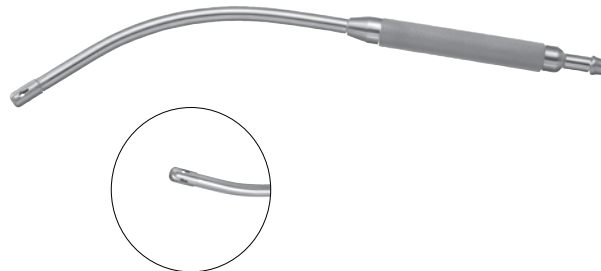

### Cooley Sump-Suction Tube

entire tube removable from handle

Catalog #	Description
310-110	30° angle, 14 1/4" (362mm), 8mm wide tip
310-SFT-110	Replacement Shaft
310-TIP-110	Replacement Tip pkg/12ea
310-112	Right angle, 11 1/4" (287mm), 7mm wide tip
310-TIP-112	Replacement Tip pkg/12ea

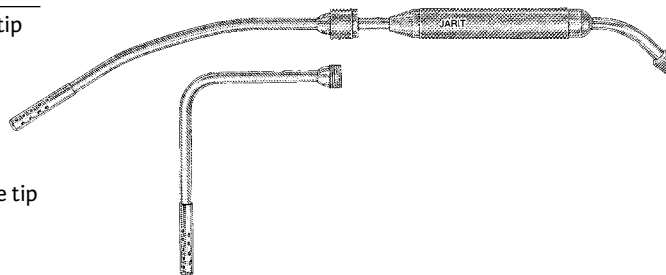

### Diethrich Coronary Artery Bypass Kit

Catalog #	Description
<b>310-380</b>	Coronary Artery Bypass Kit Set consisting of:
<b>310-350</b>	1ea Coronary Artery Scissors, 7¼" (182mm), 25° angle
<b>350-351</b>	1ea Coronary Artery Scissors, 7" (180mm), 45° angle
<b>310-352</b>	1ea Coronary Artery Scissors, 7" (177mm), 60° angle
<b>310-353</b>	1ea Coronary Artery Scissors, 6¾" (172mm), 90° angle
<b>310-360</b>	1ea Circumflex Artery Scissors, 6¾" (172mm), 130° angle
<b>140-330</b>	1ea Gemini Clamp, 7" (180mm)
<b>320-114</b>	2ea DeBakey-Diethrich Coronary Artery Forceps, 7¾" (195mm)
<b>320-170</b>	2ea Diethrich Micro Coronary Bulldog Clamps, 8mm
<b>320-172</b>	2ea Diethrich Micro Coronary Bulldog Clamps, 12mm
<b>310-383</b>	2ea Heparin Flushing Needle, 2" (51mm)
<b>310-385</b>	1ea Set of 9 Garrett Vascular Dilators, 8¼" (210mm)
<b>310-381</b>	1ea Instrument Case

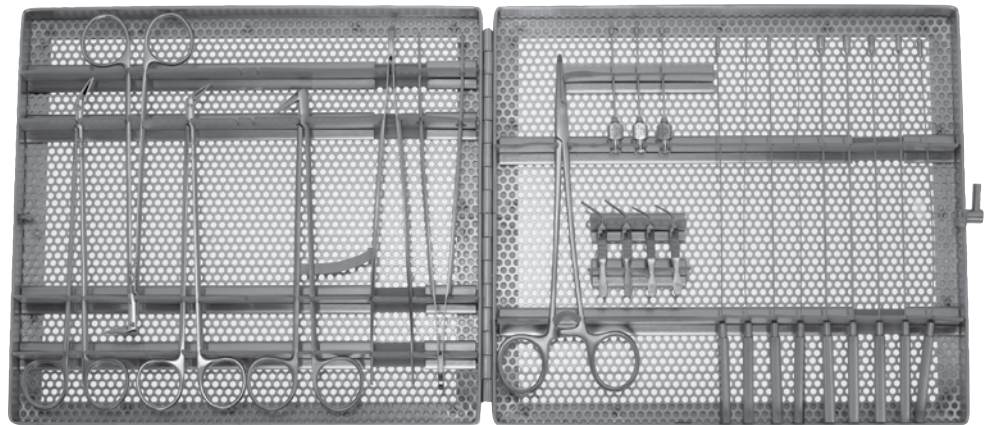

### Stopcock, Female to Male Luer Lock Tip

Catalog #	Description
<b>310-377</b>	Female luer lock right-side connection



### Luer Lock Adaptor

Catalog #	Description
310-378	For 1/8" tubing, male luer lock to hose end



### Stoney Heparin Injector

Catalog #	Description
310-379	1 7/8" (48mm)



### DeBakey Heparin Cannula

Catalog #	Description
310-382	6 1/4" (160mm), malleable, 5mm tip



### Heparin Flushing Needle

Catalog #	Description
310-383	2" (51mm), malleable, 3mm tip



### DeBakey Heparin Cannula

Catalog #	Description
310-384	2 1/8" (54mm), malleable, 3.5r



### Garrett Vascular Dilator Set

Catalog #	Description
310-385	8¼" (210mm), set of 9, with holder

### Garrett Vascular Dilators (Individual Sizes)

8¼" (210mm)

Catalog #	Description
310-386	1.0mm tip size
310-387	1.5mm tip size
310-388	2.0mm tip size
310-389	2.5mm tip size
310-390	3.0mm tip size
310-391	3.5mm tip size
310-392	4.0mm tip size
310-393	4.5mm tip size
310-394	5.0mm tip size

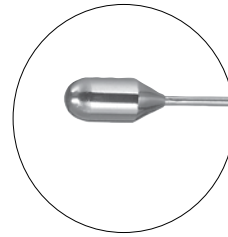

### Garrett Vascular Dilator Set

Catalog #	Description
310-395	5½" (140mm), set of 9, with holder

### Garrett Vascular Dilators (Individual Sizes)

5½" (140mm)

Catalog #	Description
310-396	1.0mm tip size
310-397	1.5mm tip size
310-398	2.0mm tip size
310-399	2.5mm tip size
310-400	3.0mm tip size
310-401	3.5mm tip size
310-402	4.0mm tip size
310-403	4.5mm tip size
310-404	5.0mm tip size



**Garrett Vascular Dilator Case, (not included with set)**

Catalog #	Description
310-405	9" x 5 1/8" x 3/4" (230mm x 130mm x 20mm)

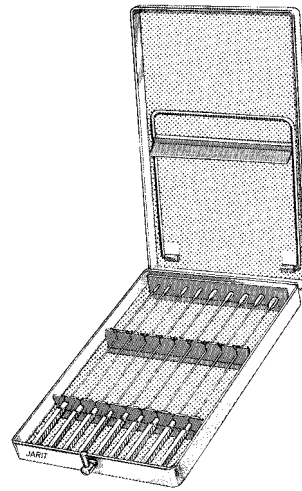

**Garrett Vascular Dilator Holder**

Catalog #	Description
310-406	7 3/4" (200mm)
310-407	5 1/2" (140mm)



**Cooley Vascular Dilator Set**

5 1/8" (130mm), set of 6

Catalog #	Description
310-410	malleable silver shaft

**Cooley Vascular Dilators (Individual Sizes)**

5 1/8" (130mm)

Catalog #	Description
310-411	0.5mm tip size
310-412	1.0mm tip size
310-413	1.5mm tip size
310-414	2.0mm tip size
310-415	2.5mm tip size
310-416	3.0mm tip size



### DeBakey Vascular Dilator Set

Catalog #	Description
310-450	7½" (190mm), set of 12

### DeBakey Vascular Dilators (Individual Sizes)

7½" (190mm)

Catalog #	Description
310-451	1.0mm tip size
310-452	1.5mm tip size
310-453	2.0mm tip size
310-454	2.5mm tip size
310-455	3.0mm tip size
310-456	4.0mm tip size
310-457	5.0mm tip size
310-458	6.0mm tip size
310-459	7.0mm tip size
310-460	8.0mm tip size
310-461	9.0mm tip size
310-462	10.0mm tip size



### DeBakey Vascular Dilator Case, (not included in set)

Catalog #	Description
310-465	9¼" x 5¾" x ½" (232mm x 146mm x 13mm)



### Serrefine Forceps

Catalog #	Description
105-260	1½" (37mm), straight
105-261	1½" (37mm), curved
105-262	2¾" (59mm), straight
105-263	2¾" (59mm), curved



### Bulldog Clamp Applying Forceps

Catalog #	Description
310-430	9¼" (235mm)



### John Hopkins Bulldog Clamps

Catalog #	Description
310-431	1½" (38mm), straight, 12mm serrated jaws
310-432	1⅞" (48mm), straight, 16mm serrated jaws
310-433	2¼" (57mm), straight, 20mm serrated jaws
310-436	3" (76mm), straight, 39mm serrated jaws
310-440	1½" (38mm), curved, 12mm serrated jaws
310-441	1⅞" (48mm), curved, 16mm serrated jaws
310-442	2¼" (57mm), curved, 20mm serrated jaws
310-445	3" (76mm), curved, 39mm serrated jaws



### Lemmon Intima Dissectors

7" (175mm), 3.5mm wide dissector blade

Catalog #	Description
310-480	Slight curve
310-481	Medium curve
310-482	Full curve



**Olivecrona Double Ended Dissectors**

Catalog #	Description
310-485	7¼" (185mm), delicate
310-486	9½" (241mm), delicate
310-487	7¾" (196mm), heavy
310-488	9½" (241mm), heavy



**Tubbs Mitral Valve Dilator**

7¾" (200mm) overall working length

Catalog #	Description
310-520	Maximum blade opening 1¾" (45mm)

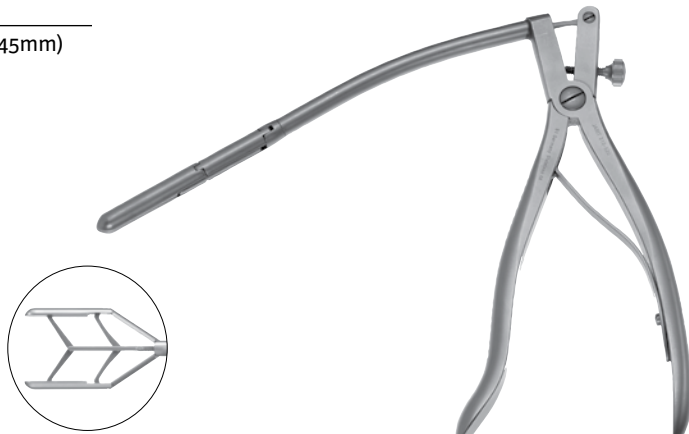

**Bailey Aortic Valve Rongeur**

4½" (115mm) overall working length

Catalog #	Description
310-522	3.1mm x 7.8mm jaws





### Deep Arteriotomy Spring Retractor

3<sup>3</sup>/<sub>8</sub>" (86mm)

Catalog #	Description
310-530	Blades 1/2" x 7/16" (12.8mm x 11.1mm)

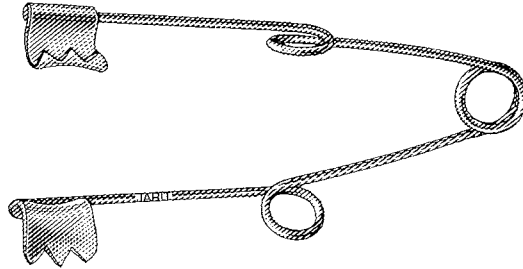

### In-Situ Bypass Hooks

7" (178mm)

Catalog #	Description
310-532	2mm round tip
310-533	3mm ball tip

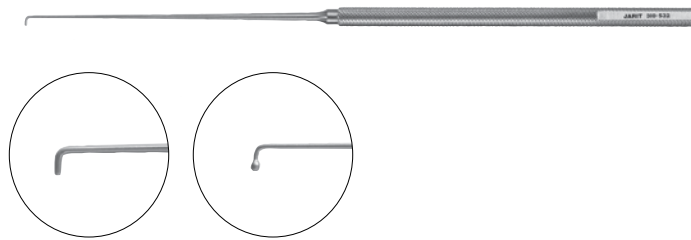

### Ball Nerve Hooks

Catalog #	Description
310-545	7 <sup>1</sup> / <sub>4</sub> " (185mm), 10mm angled tip
310-544	7 <sup>3</sup> / <sub>4</sub> " (197mm), 25mm angled tip



### Mills Endarterectomy Spatula

7" (175mm)

Catalog #	Description
310-547	1.5mm blade



### Plaque Retrievers

Catalog #	Description
310-551	Mini: 6½" (165mm), curved jaws 2" (50mm)
310-550	Short: 7¼" (185mm), angled jaws 5/16" (8mm)
310-549	Long: 8" (202mm), angled jaws 1½" (30mm)

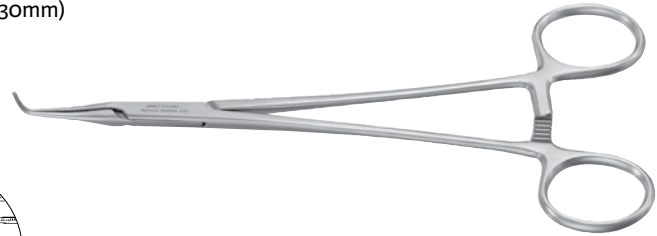

### Nabatoff Vein Stripper

Catalog #	Description
160-120	Complete set in stainless steel case
160-HDL-120	Replacement T-Handle
160-CBL-120	Replacement Cable 35"
160-OLV-120-3	Replacement 3mm olive
160-OLV-120-6	Replacement 6mm olive
160-OLV-120-9	Replacement 9mm olive
160-OLV-120-12	Replacement 12mm olive
160-TIP-120	Replacement Tip for Suction Tube pkg/12ea



### Crawford-Cooly Graft Tuner

Catalog #	Description
310-570	18" (457mm), light curve, 10mm inside diameter



**Dardik Vascular Tuner**

Catalog #	Description
310-575	19½" (498mm), 8mm inner diameter, 10mm outer diameter
310-576	25¼" (642mm), 12mm inner diameter, 14mm outer diameter

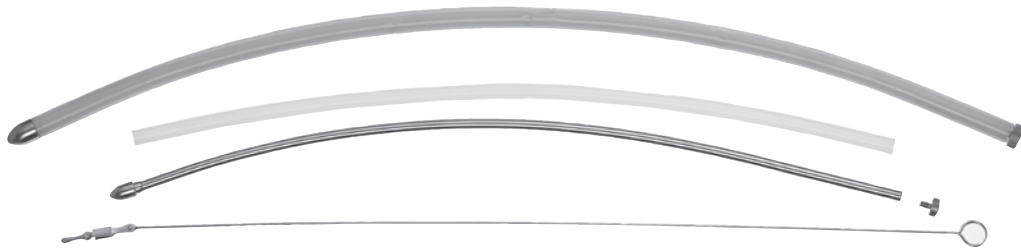

**DeBakey Femoral Bypass Tuner**

20¾" (525mm), malleable stainless steel shaft

Catalog #	Description
310-580	Tip size ⅝" x 1⅛" (30mm x 16mm)



### Mediastinal Dissecting Forceps

Catalog #	Description
295-296	11 <sup>3</sup> / <sub>4</sub> " (300mm), straight working length 4 <sup>1</sup> / <sub>2</sub> " (115mm), 16mm serrated tip



# Integra™ Cardiovascular Clamps I; Abdominal and Thoracic Instruments

## **Introduction:**

Jarit added hundreds of new cardiovascular instruments into an already extensive line of cardiovascular and thoracic instruments. The Jarit® line is now a comprehensive offering of high quality, precision instruments that meet the general and specific clinical needs of almost any cardiothoracic or vascular surgeon. We now offer a complete line of specially crafted instruments from delicate, atraumatic clamps and micro needle holders to the demanding bone cutting forceps and rib spreaders. Each instrument is made with high grade surgical stainless steel with exacting standards which provide the right "feel" surgeons demand.

### DeBakey Aortic Aneurysm Clamps

Catalog #	Description
320-280	10" (254mm), DeBakey serrations, jaw working length 3 1/8" (78mm)
320-282	10 1/2" (265mm), DeBakey serrations, jaw working length 3 1/2" (88mm)
320-284	12 1/4" (311mm), 2 x 3 DeBakey serrations, jaw working length 3 7/8" (100mm)
320-286	13" (333mm), 2 x 3 DeBakey serrations, jaw working length 4 7/8" (125mm)



### Cooley Aortic Aneurysm Clamp

Catalog #	Description
320-438	10 1/2" (267mm), Cooley serrations, jaw working length 3" (76mm)



### Howard-DeBakey Aortic Aneurysm Clamp

Catalog #	Description
320-288	11 3/4" (300mm), curved shanks, curved jaws, jaw working length 3 7/8" (100mm)



### Zanger Abdominal Aorta Clamps

Catalog #	Description
320-292	8" (202mm), DeBakey serrations, jaw working length 3 <sup>5</sup> / <sub>8</sub> " (92mm)
320-293	9 <sup>3</sup> / <sub>4</sub> " (250mm), DeBakey serrations, jaw working length 3 <sup>3</sup> / <sub>8</sub> " (85mm)
320-294	11" (280mm), 2 x 3 DeBakey serrations, jaw working length 4 <sup>1</sup> / <sub>8</sub> " (120mm)



### Wylie Abdominal Aorta Clamp

Catalog #	Description
320-291	9 <sup>3</sup> / <sub>4</sub> " (245mm), angled shanks, curved jaws, jaw working length 2 <sup>3</sup> / <sub>4</sub> " (60mm), jaw depth 20mm
320-290	10 <sup>1</sup> / <sub>4</sub> " (260mm), angled shanks, curved jaws, jaw working length 3 <sup>1</sup> / <sub>8</sub> " (65mm), jaw depth 20mm



### Wylie Hypogastric Clamp

Catalog #	Description
320-289	8 <sup>1</sup> / <sub>2</sub> " (215mm), angled shanks, curved jaws, jaw working length 2 <sup>3</sup> / <sub>4</sub> " (65mm)



### Cherry Supraceliac Clamp, 60° Handle, Double Curve

Catalog #	Description
320-287	12 <sup>1</sup> / <sub>2</sub> " (319mm), angled shanks, curved jaws, jaw working length 5 <sup>3</sup> / <sub>4</sub> " (122mm)



### Lemole-Strong Aorta Clamp

Catalog #	Description
320-257	8¼" (210mm), straight shanks, jaw working length 2" (44mm), depth 7⁄8" (22mm)
320-258	8¼" (210mm), angled shanks, jaw working length 2" (44mm), depth 7⁄8" (22mm)

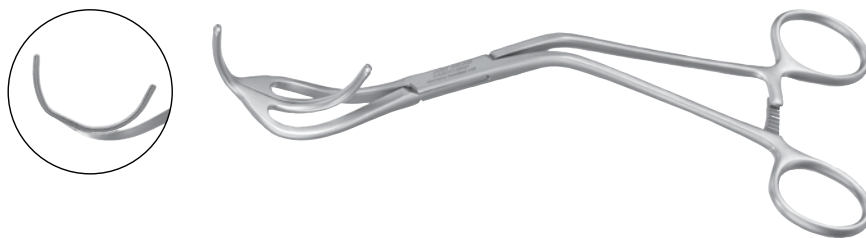

### Bahnsen Aortic Clamp

Catalog #	Description
320-263	9¼" (235mm), angled shanks, curved jaws, jaw working length 2¾" (75mm)

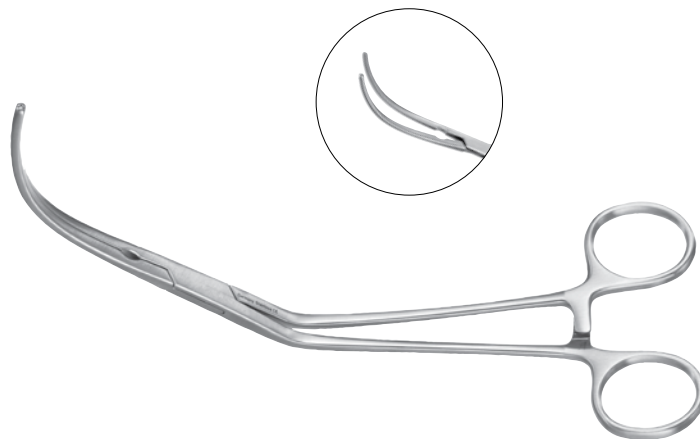

### Lambert Abdominal Aortic Aneurysm Clamp

Catalog #	Description
320-266	9¼" (235mm), angled shanks, curved jaws, jaw working length 2" (50mm)





**Grant Abdominal Aortic Aneurysm Clamps ("Texas Twister")**

2 x 3 DeBakey jaw serrations

Catalog #	Description
320-269	10" (255mm), jaw working length 1¾" (50mm), 2" (50mm) beyond curve
320-264	10½" (267mm), jaw working length 2⅝" (65mm), 2½" (65mm) beyond curve



**DeBakey Aorta Clamp (Sidewinder)**

2 x 3 DeBakey jaw serrations

Catalog #	Description
320-245	10¾" (270mm), jaw working length 2¼" (60mm) beyond curve



**Jarit Aortic Aneurysm Clamp**

DeBakey jaw serrations

Catalog #	Description
320-357	10¾" (270mm), jaw working length 2⅞" (55mm) beyond curve



**Beall-Morris Aorta Clamps**

2 x 3 DeBakey jaw serrations

Catalog #	Description
320-267	8¼" (210mm), curved shanks, angled jaws, jaw working length 2¾" (67mm) wide jaws
320-259	8¾" (225mm), curved shanks, angled jaws, jaw working length 3¾" (95mm) delicate jaws
320-268	11" (279mm), curved shanks, angled jaws, jaw working length 3" (70mm) std jaws



### Cooley Iliac Clamps

Catalog #	Description
320-494	8 <sup>3</sup> / <sub>4</sub> " (220mm), jaw working length 2 <sup>1</sup> / <sub>2</sub> " (67mm), overall jaw length 75mm
320-495	10 <sup>1</sup> / <sub>4</sub> " (260mm), jaw working length 2 <sup>1</sup> / <sub>2</sub> " (67mm), overall jaw length 75mm

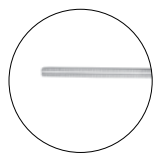

### Cooley Aorta Clamps

Catalog #	Description
320-243	10 <sup>3</sup> / <sub>4</sub> " (276mm), jaw working length 2 <sup>1</sup> / <sub>4</sub> " (55mm), depth 5 <sup>8</sup> / <sub>8</sub> " (15mm)
320-244	10" (255mm), jaw working length 3" (70mm), depth 3 <sup>4</sup> / <sub>4</sub> " (17mm)

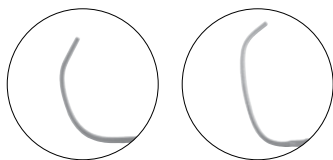

### Ochsner Aorta Clamp

Catalog #	Description
320-242	9 <sup>1</sup> / <sub>2</sub> " (240mm), angled shanks, jaw working length 2 <sup>7</sup> / <sub>8</sub> " (60mm), depth 3 <sup>4</sup> / <sub>4</sub> " (18mm)



### Diethrich Aorta Clamp

Catalog #	Description
320-246	7 <sup>3</sup> / <sub>4</sub> " (200mm), angled shanks, jaw working length 2" (47mm), depth 5 <sup>8</sup> / <sub>8</sub> " (16mm)

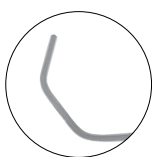

### Kay Aorta Clamp

Catalog #	Description
320-247	7¾" (200mm), angled shanks, jaw working length 2¼" (45mm), depth 1⅛" (32mm)



#### Titanium

### Lambert-Kay Aorta Clamp

Catalog #	Description
320-728TI	7¾" (200mm), jaw working length 1⅞" (48mm), depth ¾" (23mm)



### Lambert-Kay Aorta Clamp

Catalog #	Description
320-248	7¾" (200mm), angled shanks, jaw working length 2" (50mm), depth ¾" (32mm)



### Wylie "J" Clamp

Catalog #	Description
320-249	8" (203mm), curved shanks, jaw working length 1¾" (45mm), depth 1⅛" (32mm)



### DeBakey Tangential Occlusion Clamps

Catalog #	Description
320-320	7¾" (197mm), jaw working length 1¾" (45mm), depth ½" (12mm)
320-322	10" (254mm), jaw working length 2⅛" (55mm), depth ¾" (18mm)
320-324	10¼" (260mm), jaw working length 2½" (60mm), depth ¾" (18mm)
320-326	10½" (265mm), jaw working length 2⅝" (65mm), depth ¾" (18mm)
320-328	11" (279mm), jaw working length 3" (80mm), depth ¾" (18mm)



### Cooley Tangential Occlusion Clamps

Catalog #	Description
320-447	7¾" (194mm), jaw working length 1" (25mm), depth ⅝" (8mm)
320-448	7¾" (195mm), jaw working length 1⅛" (30mm), depth ⅝" (10mm)
320-449	8" (202mm), jaw working length 1½" (38mm), depth ⅝" (10mm)

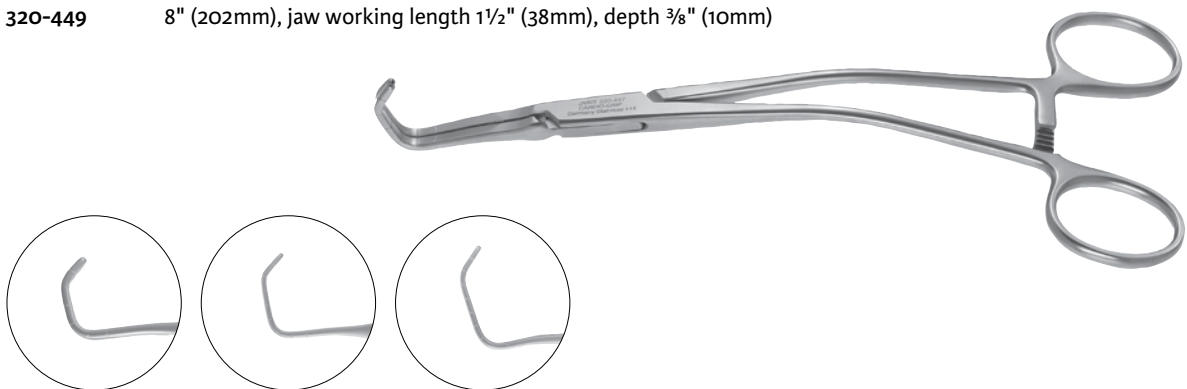

### Cooley Partial Occlusion Clamps

Catalog #	Description
320-335	8" (205mm), jaw working length 1" (23mm), depth 1/4" (7mm)
320-336	8 1/4" (210mm), jaw working length 1 1/2" (35mm), depth 3/8" (8mm)
320-337	8 3/4" (225mm), jaw working length 2" (52mm), depth 1/2" (12mm)
320-338	9 1/4" (235mm), jaw working length 2 3/8" (60mm), depth 1/2" (12mm)
320-339	11" (280mm), jaw working length 2 7/8" (120mm), depth 1/2" (12mm)

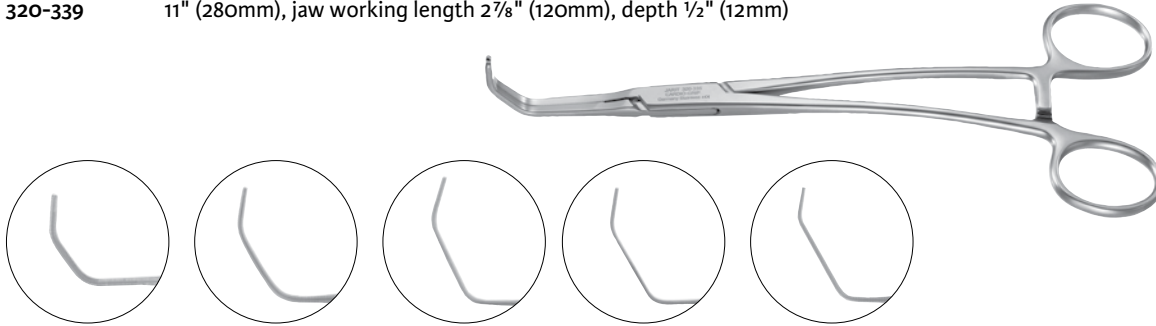

### Beck Aorta Clamps

Catalog #	Description
320-296	8" (203mm), straight shanks, jaw working length 1 1/4" (40mm), depth 1/4" (10mm)
320-297	8 1/2" (213mm), straight shanks, jaw working length 1 3/4" (45mm), depth 3/8" (10mm)
320-298	8 1/2" (216mm), straight shanks, jaw working length 2 5/8" (67mm), depth 3/8" (10mm)

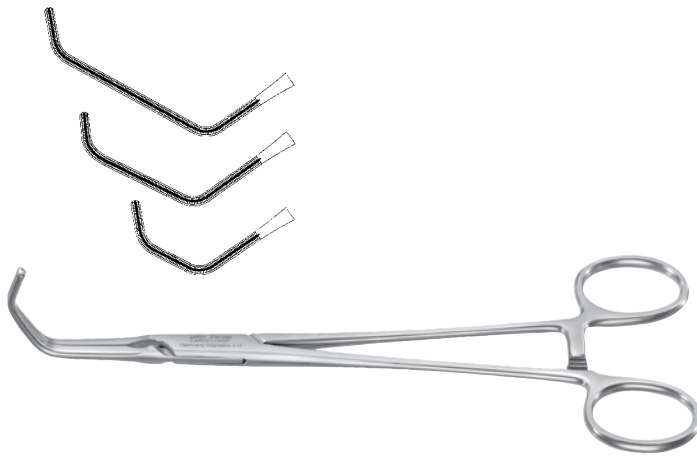

### Satinsky Vena Cava Clamps

Catalog #	Description
320-390	9 1/2" (240mm), jaw working length 2" (55mm), depth 3/8" (15mm), large
320-391	9 1/2" (240mm), jaw working length 1 5/8" (45mm), depth 3/8" (13mm), medium
320-392	9 1/2" (240mm), jaw working length 1 3/8" (35mm), depth 1/4" (10mm), small

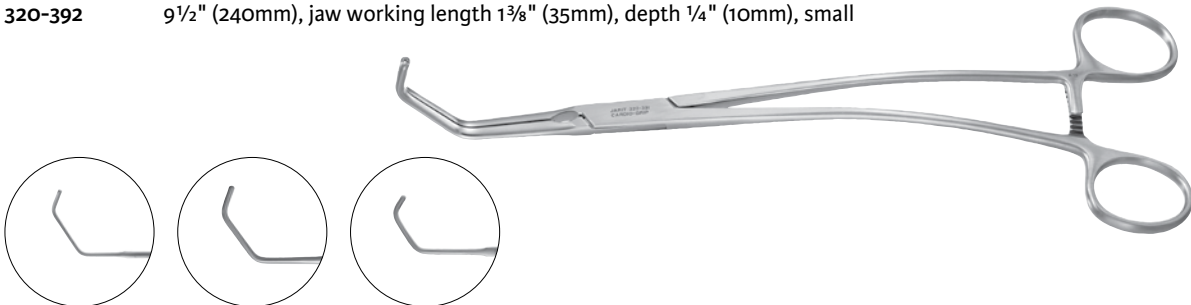

### Satinsky Vena Cava Clamps

Catalog #	Description
310-204	6¼" (160mm), cross-serrated, pediatric sizes, jaw working length 30mm, jaw depth 8mm
310-200	9½" (240mm), cross-serrated, jaw working length 55mm, jaw depth 12mm
310-202	10½" (265mm), cross-serrated, heavy, jaw working length 50mm, jaw depth 12mm

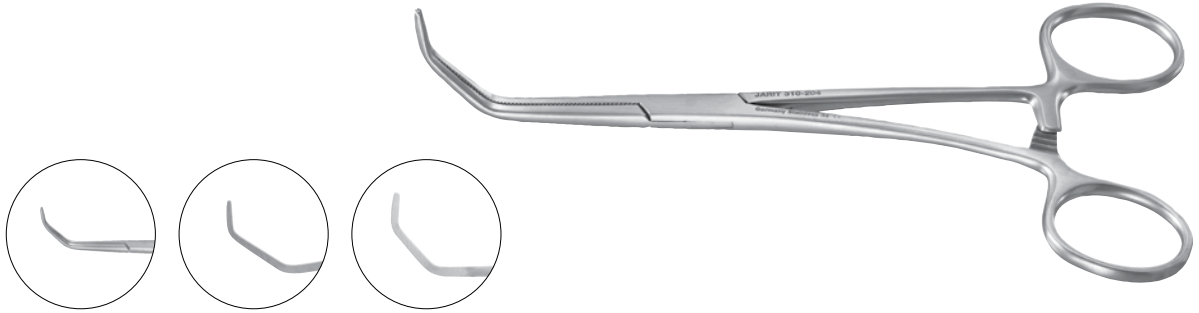

### Glover Auricular Appendage Clamp

Catalog #	Description
320-375	9½" (241 mm), jaw working length 1⅞" (45mm), depth ¼" (7mm)



### Reynolds Clamps

Catalog #	Description
320-483	50°, 7" (180mm), angled shanks, jaw working length 1¼" (33mm), depth ⅜" (5mm), small
320-484	50°, 7" (180mm), angled shanks, jaw working length 1⅜" (35mm), depth ⅜" (5mm), large
320-485	85°, 6½" (165mm), angled shanks, jaw working length 1⅞" (29mm), depth ⅜" (5mm), small
320-486	85°, 6½" (165mm), angled shanks, jaw working length 1¼" (32mm), depth ⅜" (5mm), large

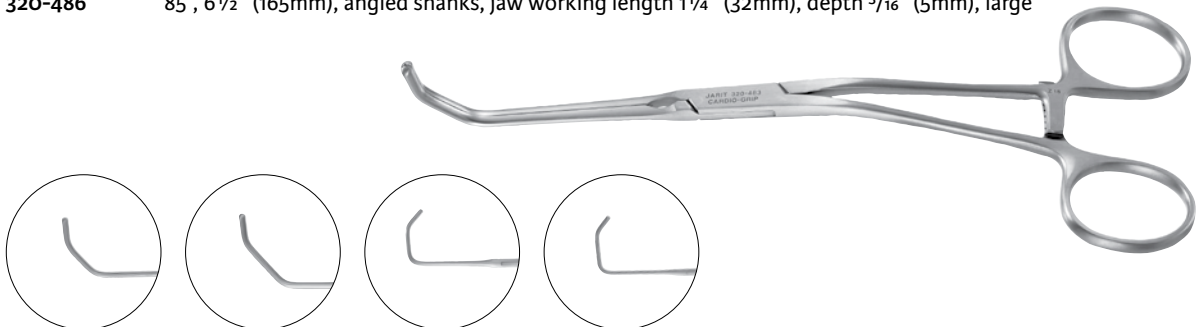

### Harken Auricle Clamps

Catalog #	Description
320-380	10" (255mm), no. 1 curve, jaw working length 2¾" (70mm)
320-381	9¾" (245mm), no. 2 curve, jaw working length 2¼" (57mm)
320-382	9½" (240mm), no. 3 curve, jaw working length 2" (50mm), jaw depth ¾" (10mm)
320-383	9¾" (245mm), no. 4 curve, jaw working length 1¾" (45mm)

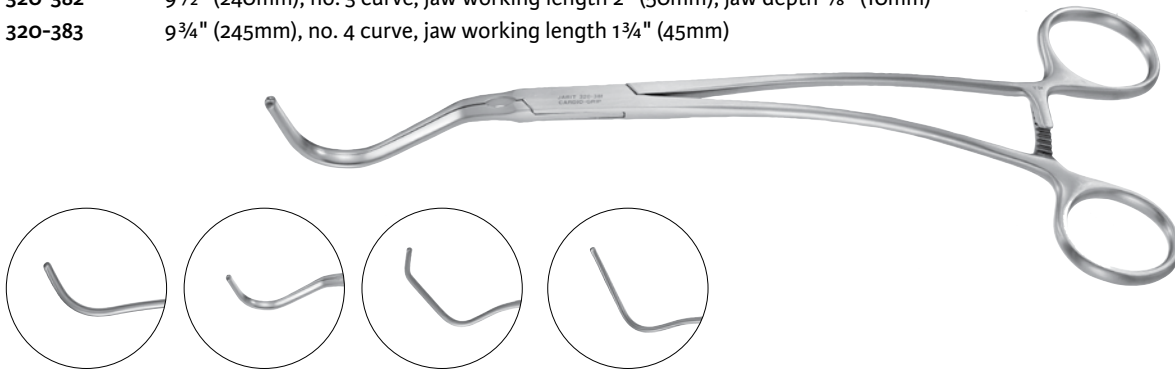

### Glover Clamps

Catalog #	Description
320-370	8¼" (210mm), straight shanks, spoon shaped jaws, jaw working length 2" (50mm)
320-372	10¼" (260mm), straight shanks, spoon shaped jaws, jaw working length 2½" (65mm)
320-360	8¼" (210mm), straight shanks, standard curve, jaw working length 2" (50mm)
320-361	9½" (240mm), straight shanks, extra long curve, jaw working length 2½" (65mm)
320-362	7¼" (185mm), straight shanks, acutely curved, jaw working length 2" (50mm)
320-363	8¾" (220mm), straight shanks, extra long acute curve, jaw working length 2⅝" (60mm)

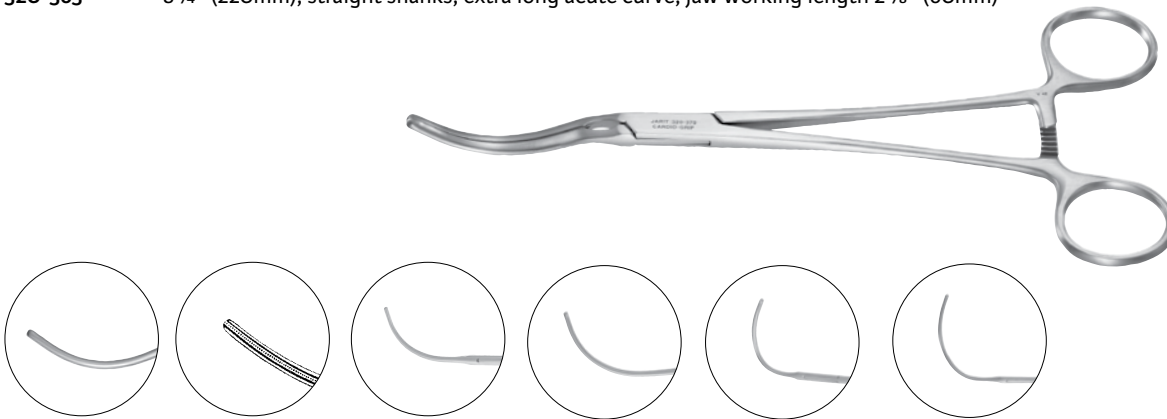

### DeBakey-Bahnson Clamps

Catalog #	Description
320-275	11 <sup>1</sup> / <sub>4</sub> " (283mm), jaw working length 3" (76mm), light curve
320-276	11" (280mm), jaw working length 2 <sup>1</sup> / <sub>2</sub> " (66mm), medium curve
320-277	10 <sup>3</sup> / <sub>4</sub> " (270mm), jaw working length 2" (50mm), acute curve



### DeBakey-Vascular Clamps

Catalog #	Description
320-270	9 <sup>3</sup> / <sub>4</sub> " (245mm), curved shanks, curved jaws, jaw working length 2" (50mm)
320-272	9 <sup>3</sup> / <sub>4</sub> " (250mm), curved shanks, fully curved jaws, jaw working length 3" (75mm), jaw depth 30mm



### Coolley Multi-Purpose Clamps

Catalog #	Description
320-472	8" (203mm), jaw working length 1 <sup>3</sup> / <sub>8</sub> " (35mm), depth 5/ <sub>8</sub> " (16mm)
320-473	8" (203mm), jaw working length 1 <sup>5</sup> / <sub>8</sub> " (40mm), depth 3/ <sub>4</sub> " (19mm)





### DeBakey Multi-Purpose Clamps, 60° Angle

Catalog #	Description
320-302	8¼" (210mm), jaw working length 2⅛" (55mm)
320-304	9½" (241mm), jaw working length 2¾" (70mm)
320-300	10" (254mm), jaw working length 1⅝" (40mm)
320-306	12" (305mm), jaw working length 4" (100mm)

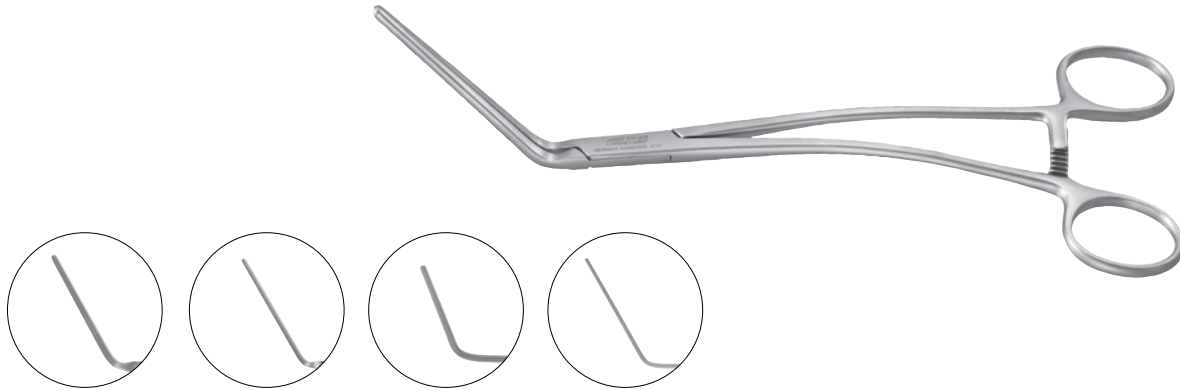

### Leland Jones Peripheral Vascular Clamps

Catalog #	Description
320-215	7¾" (195mm), straight jaws, jaw working length 2¾" (70mm)
320-216	7¾" (195mm), 15° angle jaws, jaw working length 2¾" (70mm)
320-217	7½" (190mm), 30° angle jaws, jaw working length 2¾" (70mm)

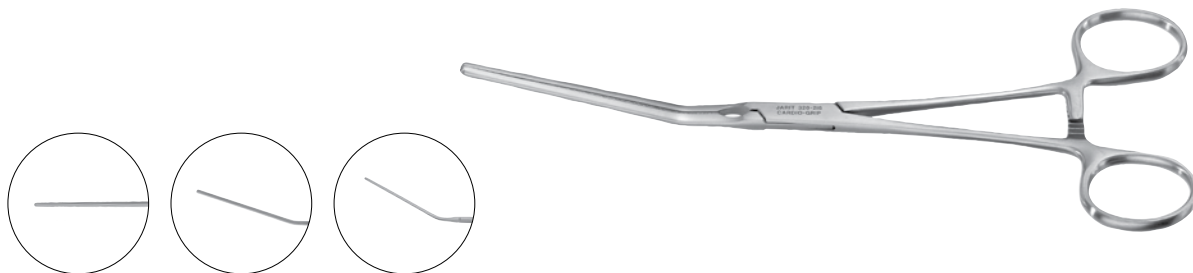

### Cooley Peripheral Vascular Clamps

Catalog #	Description
320-209	6¾" (171mm), straight shanks, straight jaws, jaw working length 1¾" (45mm)
320-210	6½" (165mm), curved shanks, 55° angle jaws, jaw working length 1⅝" (40mm)
320-211	6¾" (171mm), curved shanks, 55° angle jaws, jaw working length 1¾" (45mm)
320-212	7¼" (182mm), curved shanks, 55° angle jaws, jaw working length 2½" (63mm)
320-213	7" (178mm), curved shanks, 45° angle jaws, jaw working length 2" (50mm)
320-214	6¼" (160mm), straight shanks, curved jaws, jaw working length 1⅝" (40mm)

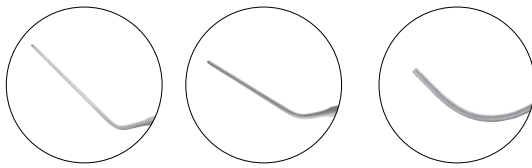

### DeBakey Peripheral Vascular Clamps

Catalog #	Description
320-250	7¼" (185mm), curved shanks, angled jaws, jaw working length 2⅜" (60mm)
320-255	7¾" (200mm), curved shanks, curved jaws, jaw working length 3" (76mm), S-shape

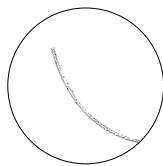
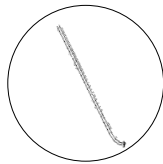

### DeBakey Aortic Exclusion Clamp

Catalog #	Description
320-260	7½" (190mm), curved shanks, curved jaws, jaw working length 2⅞" (72mm), S-shape



### DeBakey Peripheral Vascular Clamp

Catalog #	Description
320-265	6¼" (157mm), straight shanks, curved jaws, jaw working length 1⅝" (40mm)



### Bainbridge Clamps, Longitudinal Serrations

Catalog #	Description
105-300	5⅞" (150mm), straight, 1⅝" (40mm) length jaws
105-302	5⅞" (150mm), curved, 1⅝" (40mm) length jaws
105-304	7¼" (185mm), straight, 2⅜" (60mm) length jaws
105-306	7¼" (185mm), curved, 2⅜" (60mm) length jaws

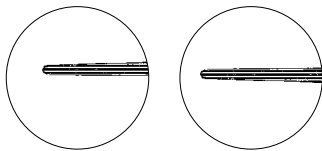

### DeBakey-Bainbridge Clamps, DeBakey Serrations

Catalog #	Description
320-228	8" (203mm), straight jaws, jaw working length 2½" (63mm), delicate
320-229	8" (203mm), curved jaws, jaw working length 2⅜" (61mm), delicate

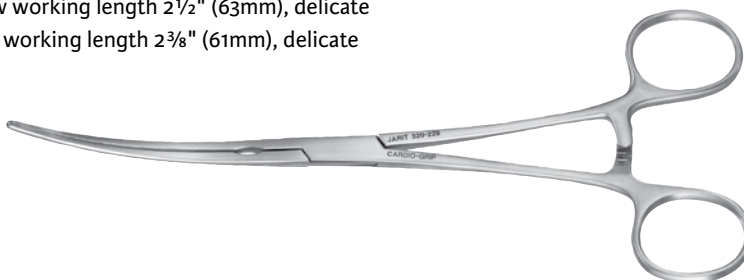
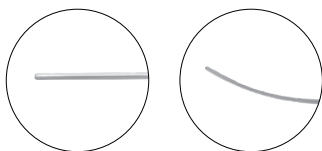

**DeBakey Bulldog Clamps, Ring Handle**

Catalog #	Description
320-180	5 1/8" (130mm), straight shanks, straight jaws, jaw working length 1 5/8" (40mm)
320-182	5 1/8" (130mm), straight shanks, curved jaws, jaw working length 1 5/8" (40mm)
320-185	5 1/8" (130mm), curved shanks, 45° angle jaws, jaw working length 1 5/8" (40mm)
320-187	3 7/8" (100mm), straight shanks, 90° angle jaws, jaw working length 1 5/8" (40mm)
320-190	4 7/8" (125mm), curved shanks, curved jaws, jaw working length 1 5/8" (42mm), S-shape

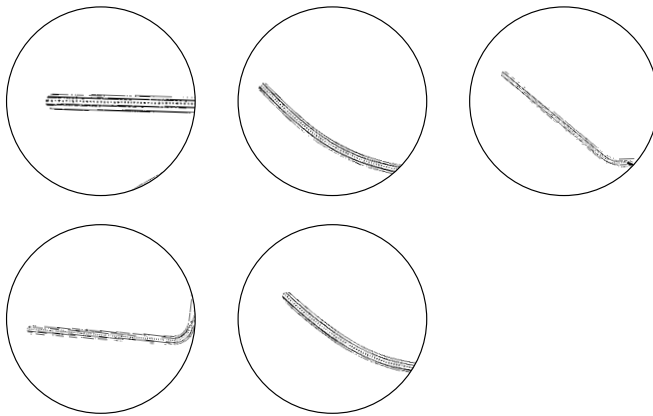

**DeBakey Coarctation Clamps**

Catalog #	Description
320-230	8 3/4" (222mm), straight shanks, straight jaws, jaw working length 2 3/8" (60mm)
320-231	8 3/4" (222mm), angled shanks, straight jaws, jaw working length 2 3/8" (60mm)

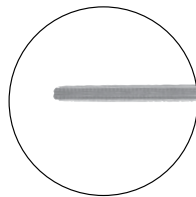

### Glover Coarctation Clamps

Catalog #	Description
320-238	9" (228mm), straight shanks, straight jaws, jaw working length 2¼" (57mm)
320-239	8¾" (222mm), angled shanks, straight jaws, jaw working length 2⅜" (60mm)
320-240	10" (257mm), straight shanks, straight jaws, jaw working length 2¾" (70mm)
320-241	10" (257mm), angled shanks, straight jaws, jaw working length 2¾" (70mm)



### Cooley Coarctation Clamps

Catalog #	Description
320-397	8¾" (222mm), straight shanks, straight jaws, jaw working length 2¼" (57mm)
320-398	8½" (217mm), angled shanks, straight jaws, jaw working length 2¼" (57mm)
320-399	9¼" (235mm), angled shanks, straight jaws, jaw working length 3" (76mm)



### Crafoord Coarctation Clamps

Catalog #	Description
310-214	9¾" (245mm), longitudinal serrations, jaw working length 2¾" (70mm)



### Cooley Patent Ductus Clamps

Catalog #	Description
320-395	8½" (213mm), straight shanks, straight jaws, jaw working length 1⅞" (30mm)
320-396	8½" (213mm), angled shanks, straight jaws, jaw working length 1⅞" (30mm)



### DeBakey Patent Ductus Clamps

Catalog #	Description
320-233	7¾" (194mm), straight shanks, straight jaws, jaw working length 1⅞" (30mm)
320-234	7½" (191mm), angled shanks, straight jaws, jaw working length 1¼" (32mm)

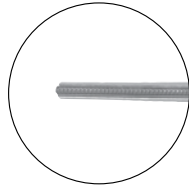

### Glover Patent Ductus Clamps

Catalog #	Description
320-235	8" (205mm), straight shanks, straight jaws, jaw working length 1⅞" (30mm)
320-236	8" (205mm), angled shanks, straight jaws, jaw working length 1⅞" (30mm)

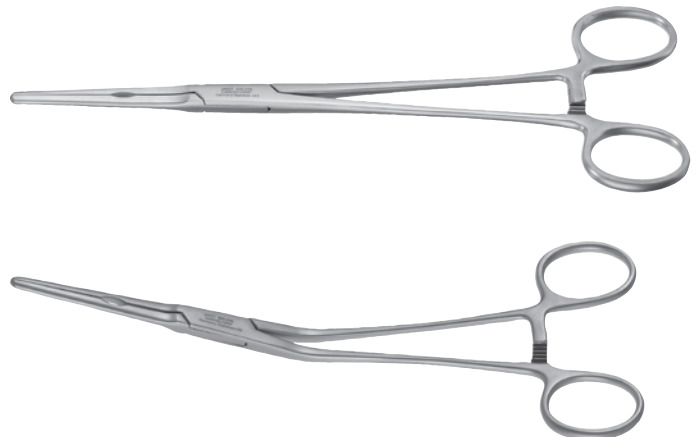
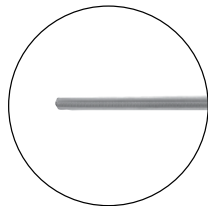

### Gregory Profunda Clamps

Catalog #	Description
320-218	5" (128mm), jaw working length 1 $\frac{5}{8}$ " (40mm), delicate
320-220	6" (152mm), jaw working length 1 $\frac{3}{4}$ " (45mm)
320-221	7 $\frac{1}{4}$ " (187mm), jaw working length 2 $\frac{3}{8}$ " (60mm)
320-222	7 $\frac{3}{4}$ " (197mm), jaw working length 2 $\frac{3}{4}$ " (70mm)

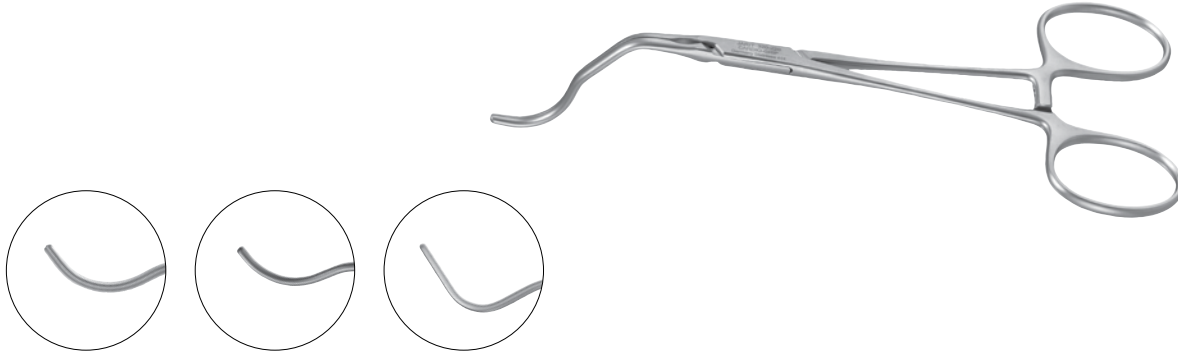

### Dale Femoral-Popliteal Clamps

Catalog #	Description
320-225	7" (178mm), jaw working length 2" (50mm), depth 1/2" (12mm), small
320-226	7" (178mm), jaw working length 2 $\frac{1}{8}$ " (55mm), depth 3/4" (19mm), medium
320-227	7" (178mm), jaw working length 2 $\frac{1}{8}$ " (55mm), depth 1" (25mm), large



### Renal Artery Clamps

Catalog #	Description
320-480	Overall jaw length 2 $\frac{3}{8}$ " (60mm), jaw working length 3/4" (20mm)
320-481	Overall jaw length 2 $\frac{7}{8}$ " (73mm), jaw working length 1" (25mm)
320-482	overall jaw length 4" (100mm), jaw working length 1 $\frac{1}{8}$ " (30mm)

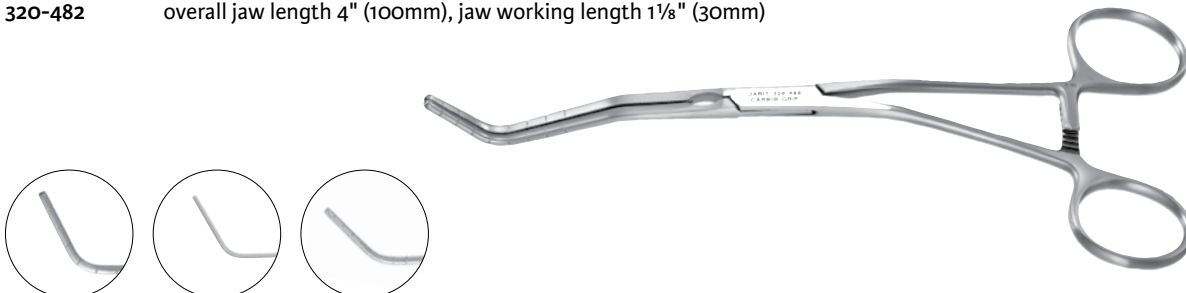

### Henly Vacular Clamp

Catalog #	Description
320-262	7¾" (200mm), double angled jaws, jaw working length 3⅛" (80mm)

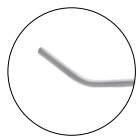

### Demos Tibial Artery Clamp

Catalog #	Description
320-223	8¼" (210mm), jaw working length 1⅝" (42mm), perpendicular ring handle



### DeBakey Multi-Purpose Clamps, 90° angle

Catalog #	Description
320-312	7" (180mm), jaw working length 2⅛" (55mm)
320-314	8½" (215mm), jaw working length 3" (75mm)
320-310	9" (230mm), jaw working length 1⅝" (40mm)
320-316	10¾" (275mm), jaw working length 4⅛" (105mm)



### Lee Right Angle and Bronchus Clamps

Catalog #	Description
320-200	9" (230mm), right angle clamp, jaw working length 1⅝" (40mm) beyond angle
320-205	9¾" (250mm), bronchus clamp, jaw working length 1⅝" (40mm) beyond angle





### Sarot Bronchus Clamps

Catalog #	Description
305-450	8¾" (225mm), jaw working length 1⅜" (35mm), right
305-451	8¾" (225mm), jaw working length 1⅜" (35mm), left

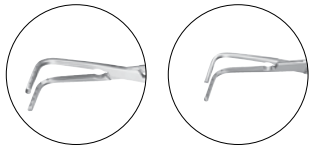

### Harken Auricle Clamps

Catalog #	Description
310-190	Cross-serrated, no. 1 curve, 9½" (243mm), jaw working length 1¾" (45mm), jaw depth ¾" (20mm)
310-191	Cross-serrated, no. 2 curve, 9¾" (248mm), jaw working length 1¾" (45mm), jaw depth ⅝" (15mm)
310-192	Cross-serrated, no. 3 curve, 9¼" (235mm), jaw working length 1¾" (45mm), jaw depth ⅜" (10mm)
310-193	Cross-serrated, no. 4 curve, 9¼" (235mm), jaw working length 1¾" (45mm), jaw depth ¾" (20mm)

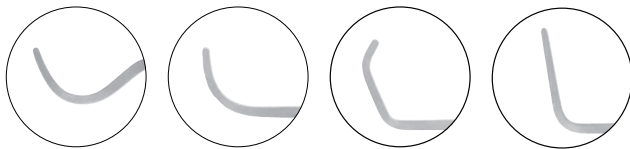

### Stille Vessel Clamps

Catalog #	Description
475-500	8¾" (225mm), horizontal serrations, jaw working length 2⅞" (74mm)



### Mayo (Guyon) Vessel Clamp

Catalog #	Description
475-505	10½" (265mm), horizontal serrations, jaw working length 2" (52mm)



### Herrick Kidney Clamp

Catalog #	Description
475-510	9" (228mm), longitudinal serrations, jaw working length 2" (52mm)



### Wertheim Pedicle Clamp

Catalog #	Description
475-520	10½" (265mm), horizontal serrations, jaw working length 2" (52mm)



### Wertheim-Cullen Pedicle Clamp

Catalog #	Description
475-525	8¼" (211mm), longitudinal serrations, jaw working length 2¾" (60mm)



**Integra<sup>™</sup>**  
**Cardiovascular**  
**Clamps II;**  
**Pediatric and**  
**Peripheral Vascular**  
**Instruments**

**Ochsner Forceps, Very Fine Serrated Jaws**

Catalog #	Description
105-235	4 5/8" (116mm), 90° angle

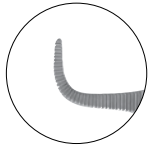

**Bainbridge Forceps, with longitudinal serrations**

Catalog #	Description
105-300	5 7/8" (150mm), straight, 40mm jaws
105-302	5 7/8" (150mm), curved, 40mm jaws

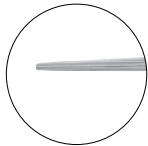

**Mixer Forceps, Pediatric**

1.7mm tips

Catalog #	Description
140-216	5 1/4" (133mm), curved
140-217	5" (126mm), right angle

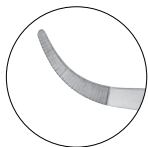

**Petit-Point Mixer Forceps, Right Angle**

Catalog #	Description
140-218	5 3/8" (137mm)



### Gemini Artery Clamp

1.3mm wide x 22.5mm length jaws

Catalog #	Description
140-329	5 <sup>3</sup> / <sub>8</sub> " (137mm)

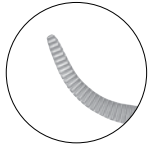

### Vascular Hemostatic Forceps

fine pattern, serrated jaws

Catalog #	Description
320-630	5 <sup>5</sup> / <sub>8</sub> " (144mm), straight, 28mm jaws
320-631	5 <sup>5</sup> / <sub>8</sub> " (143mm), curved, 27mm jaws
320-632	5 1/2" (139mm), full curve, 23mm jaws
320-633	5 <sup>5</sup> / <sub>8</sub> " (142mm), straight, 1 x 2 teeth, 27mm jaws
320-634	5 1/2" (141mm), curved, 1 x 2 teeth, 26mm jaws

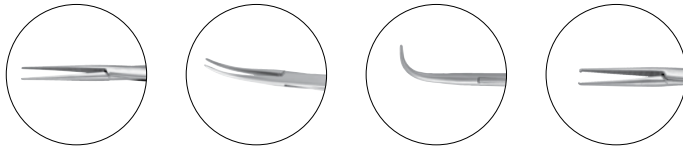

### Bailey Forceps

very fine 1mm jaws w/full serrations

Catalog #	Description
320-650	7" (180mm), 30° angle
320-651	7" (178mm), 60° angle
320-652	6 <sup>3</sup> / <sub>4</sub> " (174mm), 90° angle



**Noon AV Fistula Clamp**

50° angle

Catalog #	Description
320-192	4¾" (120mm), jaw working length 25mm



**Gregory Miniature Vascular Clamps**

curved shanks, ring handle, extra light

Catalog #	Description
320-193	4¾" (110mm), jaw working length 12mm, curved shanks, curved jaws, S-shaped
320-194	4¾" (122mm), jaw working length 25mm, curved shanks, 45° angle jaws

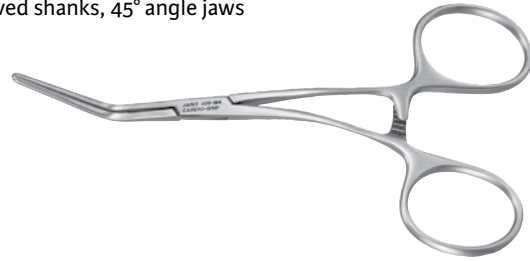
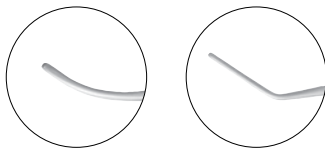

**Selman Peripheral Blood Vessel Forceps, Cooley Serrations**

Catalog #	Description
320-195	4¾" (121mm), straight jaws, jaw working length ½" (13mm)
320-196	5¼" (133mm), straight jaws, jaw working length 1" (25mm)
320-197	4¾" (121mm), angled jaws, jaw working length ½" (13mm)
320-198	5¼" (133mm), angled jaws, jaw working length 1" (25mm)

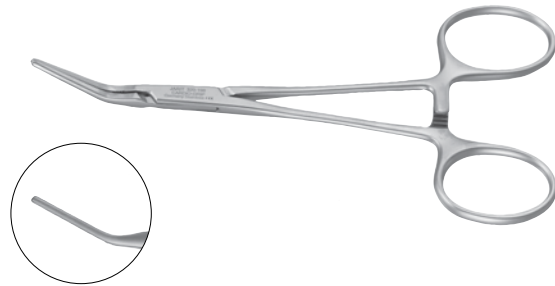

**DeBakey Multi-Purpose Clamps, Jaw Length 1¾" (35mm)**

Catalog #	Description
320-460	6½" (165mm), 30° angle, jaw working length 35mm
320-461	6" (160mm), 60° angle, jaw working length 35mm
320-462	5½" (145mm), 90° angle, jaw working length 35mm



### Cooley Multi-Purpose Clamps

Catalog #	Description
320-450	6½" (165mm), 30° angle, jaw working length 35mm
320-451	6¼" (160mm), 60° angle, jaw working length 35mm
320-452	5¾" (145mm), 90° angle, jaw working length 35mm



### Castaneda Multi-Purpose Clamps

Catalog #	Description
320-600	5½" (130mm), straight, jaw working length 35mm
320-601	5" (126mm), 30° angle, jaw working length 35mm
320-602	4⅞" (124mm), 50° angle, jaw working length 35mm
320-603	3⅞" (100mm), 90° angle, jaw working length 35mm

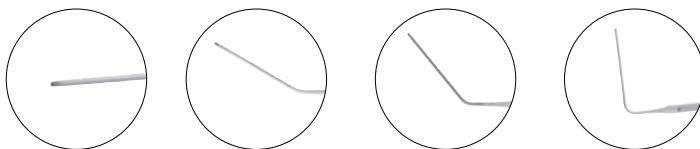

### Cooley Pediatric Multi-Purpose Clamps, 90° Angle

Catalog #	Description
320-416	4½" (115mm), jaw working length ¾" (20mm)
320-417	4½" (115mm), jaw working length 1" (25mm)
320-418	4½" (115mm), jaw working length 1⅜" (35mm)



### Dardik Multi-Purpose Clamps, "D" Clamp

Catalog #	Description
320-800	5 3/4" (146mm), jaw working length 1" (27mm), straight
320-801	5 3/4" (146mm), jaw working length 1 1/4" (30mm), 15° angle
320-802	5 3/4" (146mm), jaw working length 1 1/4" (30mm), 30° angle
320-803	5 3/4" (146mm), jaw working length 1 1/4" (30mm), 45° angle
320-804	5 1/8" (130mm), jaw working length 1 1/4" (30mm), 90° angle
320-810	6 1/4" (160mm), jaw working length 1 1/2" (41mm), straight
320-811	6 1/2" (165mm), jaw working length 1 1/2" (42mm), 15° angle
320-812	6 1/4" (160mm), jaw working length 1 1/2" (41mm), 30° angle
320-813	6" (155mm), jaw working length 1 1/2" (42mm), 45° angle
320-814	5 1/8" (130mm), jaw working length 1 1/2" (44mm), 90° angle

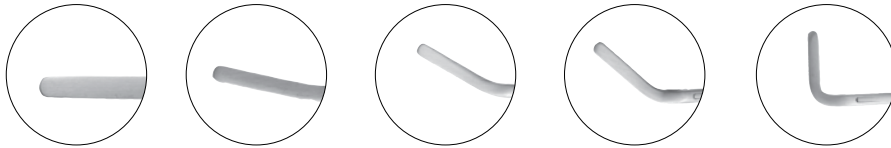



**Titanium**

**Micro Clamps, Pediatric, DeBakey Serrations**

Catalog #	Description
320-700TI	4¾" (121mm), straight shanks, jaw working length 1¼" (28mm)



320-701TI	4⅝" (119mm), slightly angled shanks, jaw working length 1¼" (28mm)
-----------	--



320-702TI	4⅜" (110mm), angled shanks, jaw working length 7⁄8" (22mm)
-----------	--



320-708TI	4⅜" (110mm), acutely angled shanks, jaw working length 1¼" (30mm)
-----------	---



**Titanium**

**Micro Clamps, Pediatric, DeBakey Serrations**

Catalog #	Description
320-703TI	4 <sup>3</sup> / <sub>8</sub> " (110mm), straight shanks, 45° angled jaw, jaw working length 1" (25mm)



320-709TI	4 <sup>1</sup> / <sub>2</sub> " (114mm), straight shanks, 45° angled jaw, jaw working length 1 <sup>1</sup> / <sub>8</sub> " (30mm)
-----------	---



320-704TI	4" (102mm), straight shanks, 60° angled jaw, jaw working length 7 <sup>7</sup> / <sub>8</sub> " (23mm)
-----------	--



320-710TI	4 <sup>3</sup> / <sub>8</sub> " (110mm), straight shanks, 60° angled jaw, jaw working length 1 <sup>1</sup> / <sub>8</sub> " (30mm)
-----------	---



Titanium

Micro Clamps, Pediatric, DeBakey Serrations

Catalog #	Description
320-706TI	4 1/8" (105mm), straight shanks, jaw working length 1/2" (14mm), jaw depth 1/4" (4mm)



320-705TI	4 1/8" (105mm), slightly angled shanks, jaw working length 1/2" (14mm), jaw depth 1/4" (6mm)
-----------	--



320-711TI	4 3/8" (112mm), slightly angled shanks, jaw working length 7/8" (22mm), jaw depth 1/4" (6mm)
-----------	--



**Titanium**

**Micro Clamps, Pediatric, DeBaKey Serrations**

Catalog #	Description
320-707TI	4 1/8" (105mm), slightly angled shanks, jaw working length 5/8" (16mm), jaw depth 3/8" (5mm)



320-712TI	4 3/8" (112mm), slightly angled shanks, jaw working length 7/16" (11mm), jaw depth 3/8" (4mm)
-----------	---



320-713TI	4 5/8" (118mm), straight shanks, spoon-shaped, jaw working length 1/2" (13mm), jaw depth 1/4" (4mm)
-----------	---



### DeBakey Patent Ductus Clamps, Delicate

Catalog #	Description
320-199	6" (152mm), straight shanks, jaw working length 1¼" (33mm), 1.9mm tips
320-453	6¾" (172mm), straight shanks, jaw working length 1⅜" (34mm), 2.8mm tips
320-454	6½" (165mm), angled shanks, jaw working length 1⅞" (30mm), 2.8mm tips

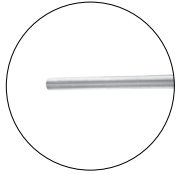

### Cooley Patent Ductus Clamps

Catalog #	Description
320-400	6¼" (160mm), straight shanks, straight jaws, jaw working length 1⅞" (30mm), 2.1mm tips
320-401	6¼" (159mm), angled shanks, straight jaws, jaw working length 1⅞" (30mm), 2.1mm tips



### DeBakey Coarctation Clamps, Delicate

Catalog #	Description
320-455	7¼" (182mm), straight shanks, straight jaws, jaw working length 1¾" (45mm), 2.8mm tips
320-456	7" (178mm), angled shanks, straight jaws, jaw working length 1¾" (43mm), 2.8mm tips
320-457	7" (180mm), straight shanks, spoon-shaped jaws, jaw working length 1¾" (43mm), 2.8mm tips

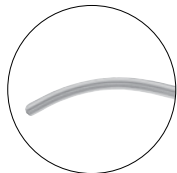
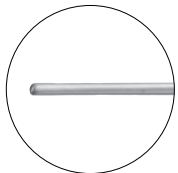

### Cooley Coarctation Clamps

Catalog #	Description
320-405	6 <sup>3</sup> / <sub>4</sub> " (171mm), angled shanks, straight jaws, jaw working length 1 <sup>5</sup> / <sub>8</sub> " (42mm), 2.1mm tips
320-403	6 <sup>3</sup> / <sub>4</sub> " (171mm), straight shanks, straight jaws, jaw working length 1 <sup>3</sup> / <sub>4</sub> " (45mm), 2.1mm tips
320-406	6 <sup>3</sup> / <sub>4</sub> " (170mm), straight shanks, curved jaws, jaw working length 1 <sup>5</sup> / <sub>8</sub> " (42mm), 2.1mm tips
320-410	7" (180mm), straight shanks, spoon-shaped jaws, jaw working length 2" (50mm), 2.1mm tips



### Cooley Pediatric Clamps

Catalog #	Description
320-411	5 <sup>1</sup> / <sub>2</sub> " (140mm), straight shanks, straight jaws, jaw working length 1 <sup>1</sup> / <sub>8</sub> " (30mm), 1.9mm tips
320-412	5 <sup>1</sup> / <sub>2</sub> " (140mm), straight shanks, angled jaws, jaw working length 1 <sup>1</sup> / <sub>8</sub> " (30mm), 1.9mm tips
320-413	5 <sup>3</sup> / <sub>4</sub> " (146mm), angled shanks, straight jaws, jaw working length 1 <sup>1</sup> / <sub>8</sub> " (30mm), 1.9mm tips
320-414	5 <sup>1</sup> / <sub>2</sub> " (140mm), straight shanks, spoon-shaped jaws, jaw working length 1 <sup>1</sup> / <sub>8</sub> " (30mm), 1.9mm tips

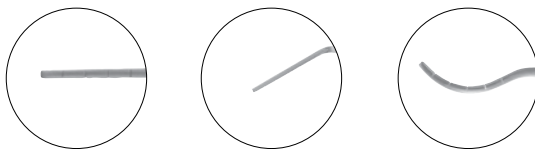

### DeBakey Peripheral Vascular Clamp

Catalog #	Description
320-265	6¼" (157mm), curved jaws, jaw working length 1⅝" (40mm), jaw depth ⅜" (10mm)



### Beck Vessel Clamps

Catalog #	Description
320-470	5⅞" (150mm), straight shanks, jaw working length 1⅞" (28mm), depth ⅝" (15mm)
320-471	6" (155mm), straight shanks, jaw working length 1⅝" (40mm), depth ¾" (18mm)

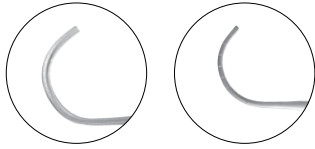

### Cooley, Multi-Purpose Clamps, Angled Shanks

Catalog #	Description
320-474	Small: 6¾" (170mm), Ligature Carrier, jaw length 1⅜" (35mm), depth ½" (12mm), length of serrations ¾" (20mm)
320-475	Medium: 6½" (165mm), jaw length 1½" (38mm), depth ⅝" (15mm)
320-476	Large: 6½" (165mm), jaw length 2" (50mm), depth ¾" (18mm)

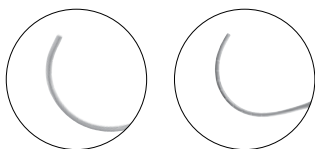

**Kitzmilller Clamps, Cooley Serrations, Jaw Length 1 1/8" (30mm), Stainless Steel**

Catalog #	Description
320-540	5 1/4" (133mm), left angled, jaw working length 3/8" (10mm)
320-542	5 1/4" (133mm), right angled, jaw working length 3/8" (10mm)

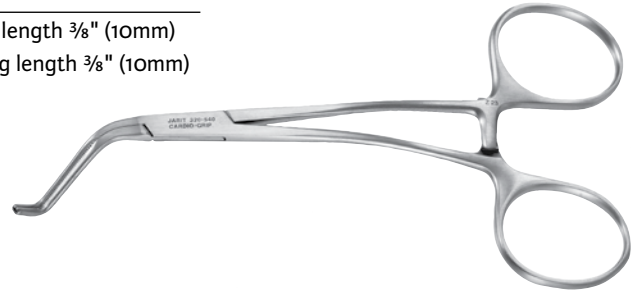

**Titanium**

**Kitzmilller Micro Clamps, DeBakey Serrations, Jaw Length 7/8" (23mm)**

Catalog #	Description
320-540TI	4 1/4" (108mm), left angled, jaw working length 5/16" (8mm)
320-542TI	4 1/4" (108mm), right angled, jaw working length 5/16" (8mm)

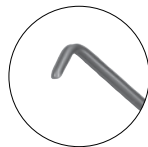



**Cooley Neonatal Vascular Clamps**

Catalog #	Description
320-500	5 1/8" (130mm), straight shanks, straight jaws, jaw working length 1 1/2" (37mm)

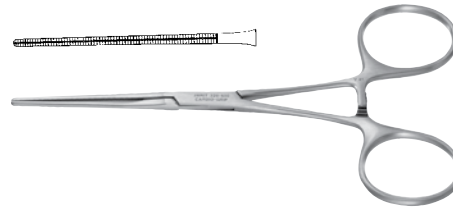

320-501	5 1/8" (130mm), angled shanks, straight jaws, jaw working length 1 1/2" (37mm)
---------	--

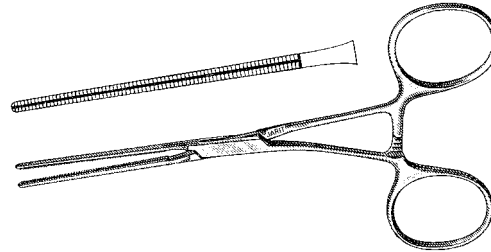

320-502	4 7/8" (125mm), curved shanks, angled jaws, jaw working length 1 3/8" (35mm)
---------	--

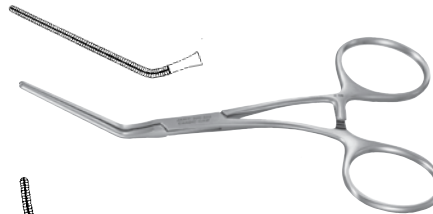

320-503	4 3/4" (122mm), straight shanks, curved jaws, working jaw length 1 1/8" (30mm)
---------	--

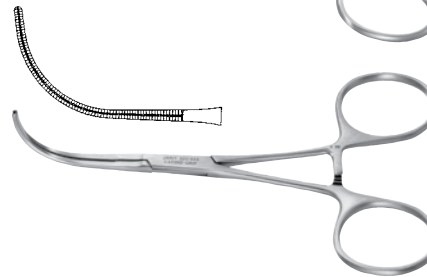

**Anastomosis Partial Occlusion Clamp**

Catalog #	Description
320-504	4 3/4" (120mm), curved shanks, jaw working length 1/2" (14mm), depth 3/16" (5mm)



**Carotid Clamp**

Catalog #	Description
320-505	4 7/8" (125mm), jaw length 1 3/8" (34mm), jaw working length 1/2" (12mm)

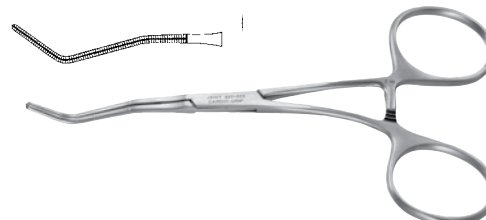

**Calman Carotid Closure Clamp**

Catalog #	Description
320-520	4 <sup>3</sup> / <sub>8</sub> " (110mm), jaw working length 1 <sup>1</sup> / <sub>8</sub> " (28mm), jaw depth <sup>3</sup> / <sub>16</sub> " (5mm)

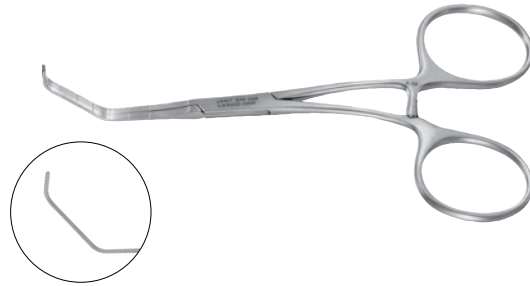

**Thompson Carotid Closure Clamp**

Catalog #	Description
320-525	6" (152mm), jaw working length 1" (25mm), jaw depth <sup>3</sup> / <sub>16</sub> " (4mm)

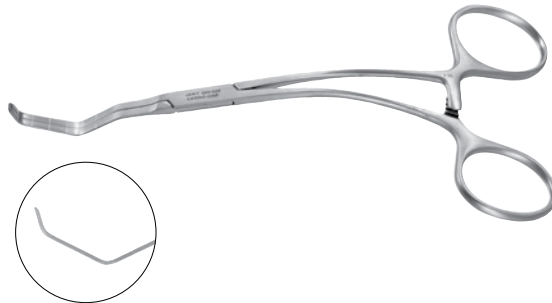

**Dennis Carotid Clamp**

DeBaakey atraumatic serrations

Catalog #	Description
320-261	7" (178mm), 2.5mm wide x 16mm jaw working length

(Not Pictured)

**Example Clamp**

Catalog #	Description
320-530	6 <sup>1</sup> / <sub>4</sub> " (159mm), jaw working length 1 <sup>1</sup> / <sub>4</sub> " (32mm), jaw depth <sup>1</sup> / <sub>4</sub> " (7mm)

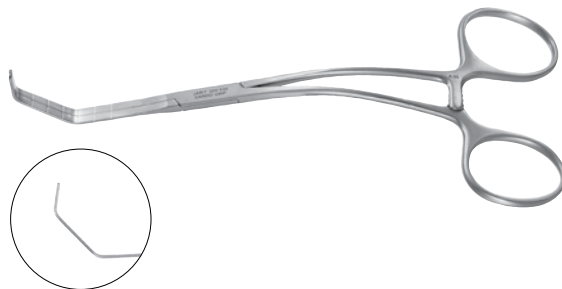

**Kartchner Internal Carotid Clamp**

Catalog #	Description
320-535	6 <sup>1</sup> / <sub>4</sub> " (160mm), jaw length 1 <sup>3</sup> / <sub>4</sub> " (45mm), jaw working length <sup>1</sup> / <sub>2</sub> " (12mm)

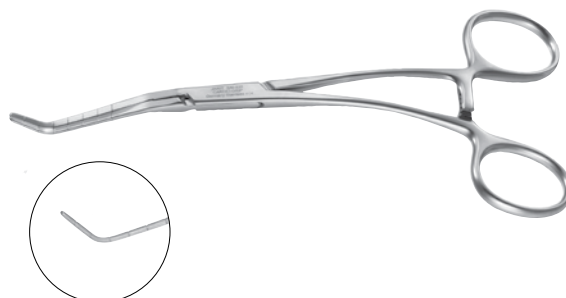

### Gregory Profunda Clamp

Catalog #	Description
320-218	5" (128mm), jaw working length 1 1/8" (29mm), delicate



### Beck Miniature Aorta Clamp

Catalog #	Description
320-487	6 1/2" (165mm), jaw working length 1 1/8" (30mm), jaw depth 3/16" (5mm)

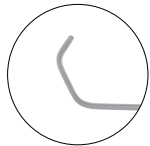

### Subramanian Miniature Aorta Clamp

Catalog #	Description
320-490	6" (152mm), jaw working length 1 1/8" (30mm) beyond curve

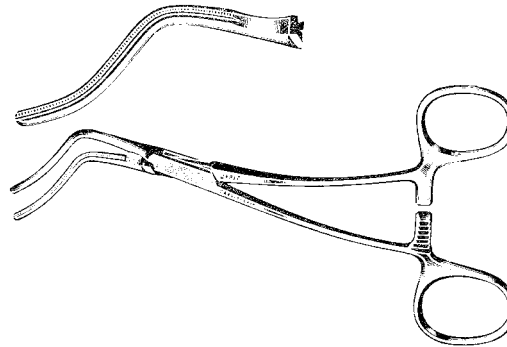

### Cooley-Satinsky Clamp

Catalog #	Description
320-415	5 1/2" (140mm), jaw working length 1 1/8" (28mm), jaw depth 1/4" (7mm)



### Cooley Pediatric Vascular Clamps

Catalog #	Description
320-506	5½" (140mm), curved shanks, jaw working length ⅝" (16mm), jaw depth 3/16" (5mm)
320-507	5½" (140mm), curved shanks, jaw working length ½" (12mm), jaw depth 3/16" (5mm)
320-508	5½" (140mm), curved shanks, jaw working length ⅝" (8mm), jaw depth 3/16" (5mm)



### Cooley Vascular Clamps, 90° Angle

Catalog #	Description
320-440	6½" (165mm), jaw working length 1⅝" (27mm), jaw depth ¼" (7mm)
320-441	6½" (165mm), jaw working length 1¼" (32mm), jaw depth ¼" (7mm)

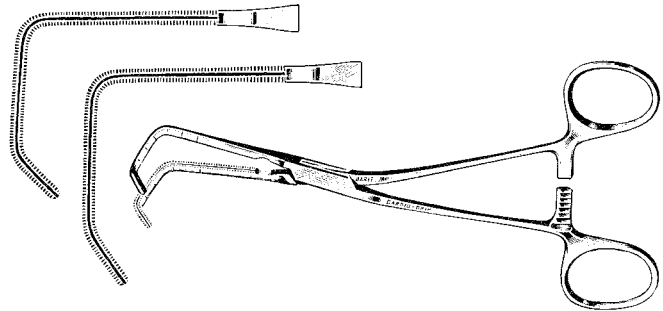

### Cooley Vascular Clamps, 60° Angle

7" (175mm)

Catalog #	Description
320-445	Small, jaw working length 1¼" (32mm), jaw depth ¼" (7mm)
320-446	Large, jaw working length 1½" (37mm), jaw depth ¼" (7mm)

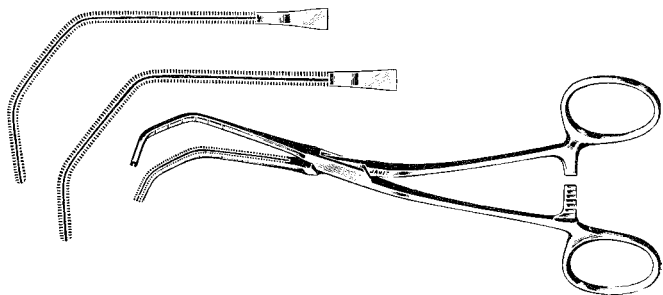

### Reynolds Clamps, 85° Angle

Catalog #	Description
320-485	6½" (165mm), jaw working length 1⅛" (29mm), jaw depth ⅜" (5mm)
320-486	6½" (165mm), jaw working length 1¼" (32mm), jaw depth ⅜" (5mm)

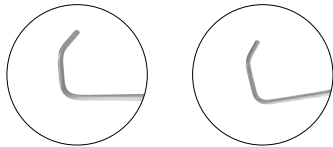

### Anastomosis Clamps

Catalog #	Description
320-420	6¾" (170mm), angled shanks, jaw working length ¾" (20mm), jaw depth ⅜" (5mm), DeBakey serrations
320-422	7" (175mm), angled shanks, jaws angled left, jaw working length ¾" (20mm), jaw depth ¼" (7mm), Cooley serrations

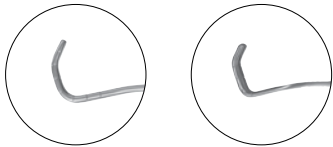

### Anastomosis Clamp

Catalog #	Description
320-425	6¾" (170mm), jaw working length ⅞" (22mm), jaw depth ¼" (7mm), Cooley serrations

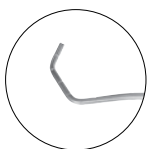

### Castaneda Anastomosis Clamps

Catalog #	Description
320-610	5 <sup>7</sup> / <sub>8</sub> " (150mm), jaw working length 5 <sup>5</sup> / <sub>8</sub> " (15mm), jaw depth 1 <sup>1</sup> / <sub>4</sub> " (6mm)
320-611	5 <sup>3</sup> / <sub>4</sub> " (146mm), jaw working length 3 <sup>3</sup> / <sub>4</sub> " (18mm), jaw depth 1 <sup>1</sup> / <sub>4</sub> " (6mm)
320-612	5 <sup>7</sup> / <sub>8</sub> " (150mm), jaw working length 1" (25mm), jaw depth 1 <sup>1</sup> / <sub>4</sub> " (6mm)

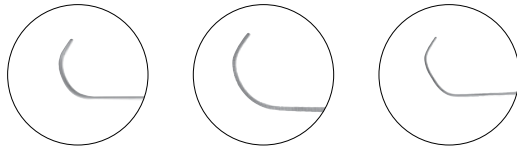

### Derra Anastomosis Clamps

Catalog #	Description
320-430	6 <sup>3</sup> / <sub>4</sub> " (170mm), jaw working length 3 <sup>3</sup> / <sub>4</sub> " (20mm), jaw depth 7 <sup>7</sup> / <sub>16</sub> " (11mm), small
320-431	6 <sup>3</sup> / <sub>4</sub> " (170mm), jaw working length 1" (25mm), jaw depth 1 <sup>1</sup> / <sub>2</sub> " (13mm), medium
320-432	6 <sup>3</sup> / <sub>4</sub> " (170mm), jaw working length 1 <sup>1</sup> / <sub>8</sub> " (30mm), jaw depth 5 <sup>5</sup> / <sub>8</sub> " (15mm), large

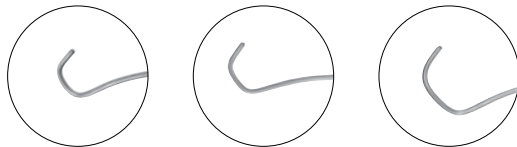

### Cooley-Derra Anastomosis Clamps

Catalog #	Description
320-435	6 <sup>1</sup> / <sub>2</sub> " (163mm), jaw working length 3 <sup>3</sup> / <sub>4</sub> " (20mm), jaw depth 7 <sup>7</sup> / <sub>16</sub> " (11mm), small
320-436	6 <sup>3</sup> / <sub>4</sub> " (170mm), jaw working length 1" (25mm), jaw depth 1 <sup>1</sup> / <sub>2</sub> " (13mm), medium
320-437	6 <sup>1</sup> / <sub>2</sub> " (165mm), jaw working length 1 <sup>1</sup> / <sub>8</sub> " (30mm), jaw depth 5 <sup>5</sup> / <sub>8</sub> " (15mm), large



### Derra Partial Occlusion Clamps

Catalog #	Description
320-433	4½" (115mm), angled shanks, jaw working length ¾" (10mm), jaw depth ⅜" (10mm), short, small curve
320-463	4½" (115mm), angled shanks, jaw working length ⅝" (16mm), jaw depth ⅜" (10mm), short, medium curve
320-464	4¾" (120mm), angled shanks, jaw working length 1⅛" (28mm), jaw depth ⅜" (10mm), short, large curve
320-465	5½" (140mm), curved shanks, jaw working length ¾" (18mm), jaw depth ⅜" (10mm), small curve
320-466	5½" (140mm), curved shanks, jaw working length ⅞" (22mm), jaw depth ⅜" (10mm), medium curve
320-467	5¾" (145mm), curved shanks, jaw working length 1" (25mm), jaw depth ⅜" (10mm), large curve

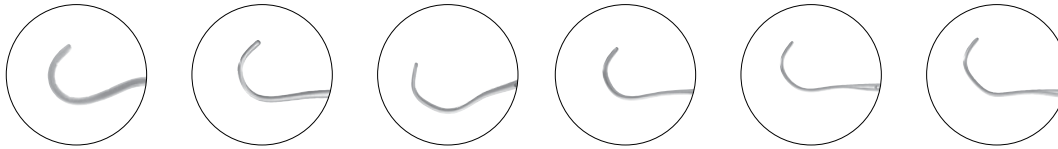

### Castaneda Partial Occlusion Clamp

Catalog #	Description
320-604	4⅞" (124mm), jaw working length 1" (24mm), jaw depth ⅝" (8mm), spoon-shape

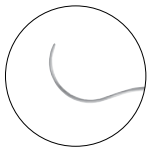

Jarit® Petit-Point® instruments feature a matched and balanced set of fine, delicate hemostats, soft-tension intestinal clamps, delicate scissors, and needle holders, for pediatric and other delicate procedures.

**Petit-Point Mosquito Forceps**

Catalog #	Description
105-090	3 <sup>7</sup> / <sub>8</sub> " (100mm), straight
105-091	3 <sup>7</sup> / <sub>8</sub> " (100mm), curved
105-095	4 <sup>3</sup> / <sub>4</sub> " (120mm), straight
105-096	4 <sup>3</sup> / <sub>4</sub> " (120mm), curved
105-098	6" (152mm), straight
105-099	6" (152mm), curved
285-107	7 <sup>1</sup> / <sub>4</sub> " (184mm), straight
285-108	7 <sup>1</sup> / <sub>4</sub> " (184mm), curved



**Petit-Point Jacobson Mosquito Forceps**

very delicate, 7<sup>1</sup>/<sub>4</sub>" (185mm), serrated jaws

Catalog #	Description
105-092	Slightly curved
105-093	Fully curved

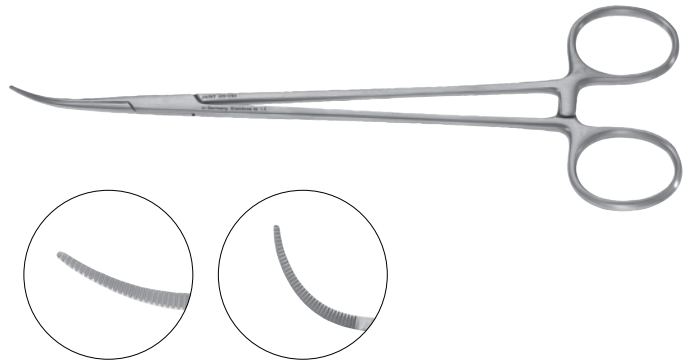

**Ochsner Forceps, Very Fine Serrated Jaws**

Catalog #	Description
105-235	4 <sup>5</sup> / <sub>8</sub> " (116mm), 90° angle

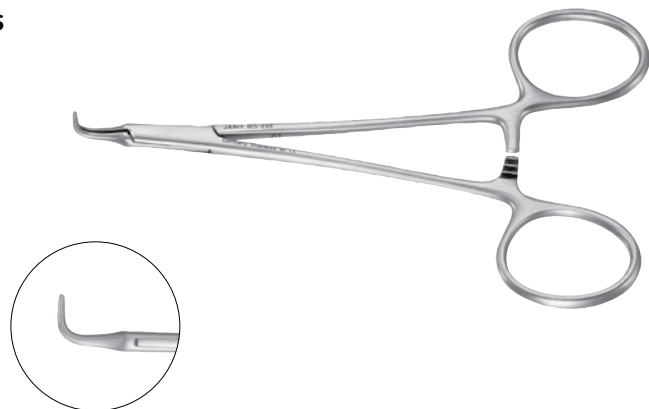



**Vascular Hemostatic Forceps**

fine pattern, serrated jaws

Catalog #	Description
320-630	5 <sup>5</sup> / <sub>8</sub> " (144mm), straight
320-635	6 <sup>1</sup> / <sub>2</sub> " (166mm), straight
320-640	7 <sup>1</sup> / <sub>4</sub> " (186mm), straight
320-631	5 <sup>5</sup> / <sub>8</sub> " (143mm), curved
320-636	6 <sup>1</sup> / <sub>2</sub> " (165mm), curved
320-641	7 <sup>1</sup> / <sub>4</sub> " (185mm), curved
320-632	5 <sup>5</sup> / <sub>8</sub> " (137mm), full curve
320-637	6 <sup>1</sup> / <sub>2</sub> " (160mm), full curve
320-642	7 <sup>1</sup> / <sub>4</sub> " (181mm), full curve

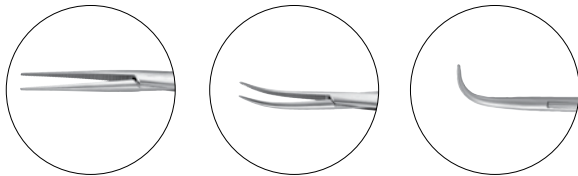

**Vascular Hemostatic Forceps**

fine pattern, 1 x 2 teeth

Catalog #	Description
320-633	5 <sup>5</sup> / <sub>8</sub> " (142mm), straight
320-638	6 <sup>1</sup> / <sub>2</sub> " (163mm), straight
320-643	7" (175mm), straight
320-634	5 <sup>1</sup> / <sub>2</sub> " (141mm), curved
320-639	6 <sup>1</sup> / <sub>2</sub> " (162mm), curved
320-644	7" (175mm), curved

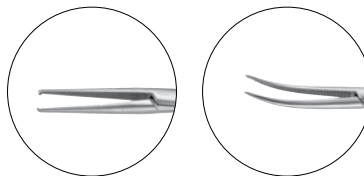

**Bailey Forceps**

very fine 1mm jaws w/full serrations

Catalog #	Description
320-650	7" (180mm), 30°
320-651	7" (178mm), 60°
320-652	6 <sup>3</sup> / <sub>4</sub> " (174mm), 90°



**DeBakey-Bainbridge Clamps, DeBakey Serrations**

Catalog #	Description
320-228	8" (203mm), straight, delicate, 63mm jaws
320-229	8" (203mm), curved, delicate, 61mm jaws

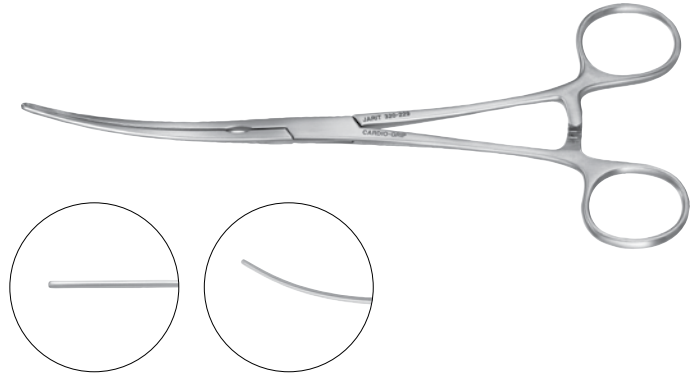

**Sternal Chest Tube Passers**

Catalog #	Description
320-620	9½" (240mm), without ratchet
320-621	9½" (240mm), with ratchet
320-622	13½" (340mm), without ratchet

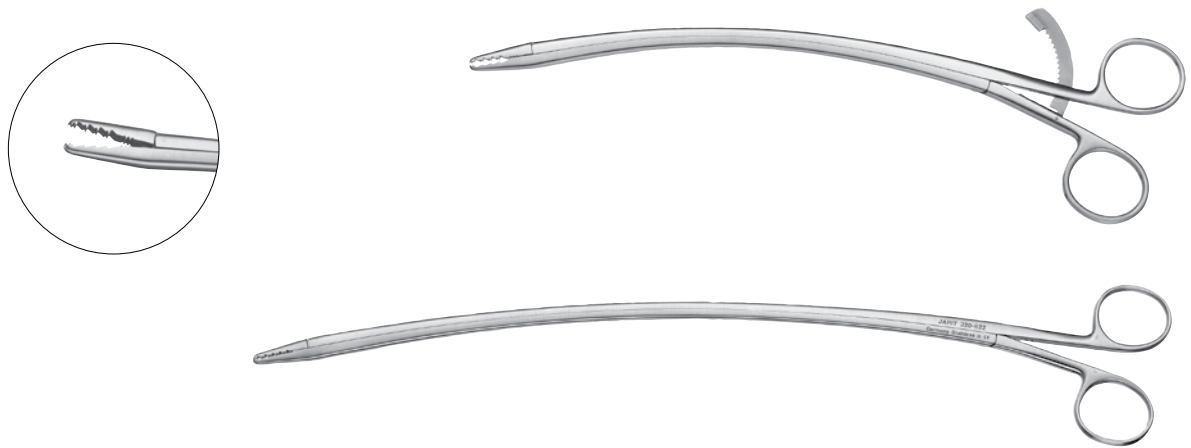

### Castaneda Suture Tag Forceps

3<sup>5</sup>/<sub>8</sub>" (93mm), numbered for identification, 14mm smooth jaws

Catalog #	Description
320-615	No. 1
320-616	No. 2
320-617	No. 3
320-618	No. 4



### Gregory Stay Suture Clamps

4<sup>3</sup>/<sub>4</sub>" (121mm), 14.5mm smooth jaws (for tricuspid valve)

Catalog #	Description
320-625	5/8" (16mm), gold band
320-626	3/4" (19mm), gold band
320-627	1 <sup>5</sup> / <sub>8</sub> " (41mm), gold band

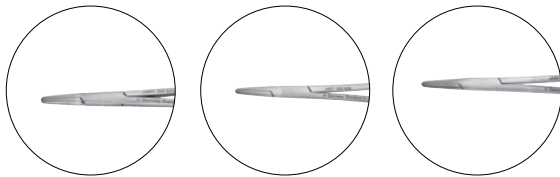

### Adson Hemostatic Forceps, Fine Tips

Catalog #	Description
285-103	8 <sup>1</sup> / <sub>2</sub> " (215mm), straight
285-104	8 <sup>1</sup> / <sub>2</sub> " (215mm), curved
285-105	7 <sup>1</sup> / <sub>2</sub> " (190mm), straight
285-106	7 <sup>1</sup> / <sub>2</sub> " (190mm), curved

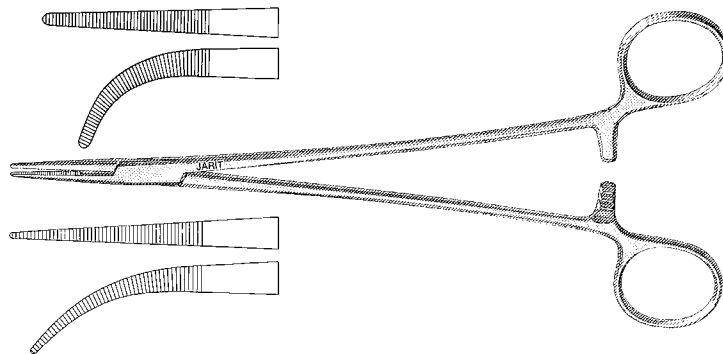

**Schmidt Tonsil Forceps, (Mirror Finish)**

Manufactured from high grade German surgical stainless steel which is ground and polished to a mirror finish

Catalog #	Description
450-310	7½" (190mm), half curved, closed rings



**Schmidt Tonsil Forceps, (Matte Finish)**

Manufactured from high grade German surgical stainless steel which is glass beaded to a matte finish

Catalog #	Description
449-310	7½" (190mm), half curved, closed rings



**Javid Carotid Artery Bypass Clamps**

Catalog #	Description
320-550	6¾" (160mm), 3.5mm ring
320-555	7¼" (182mm), 6.3mm ring

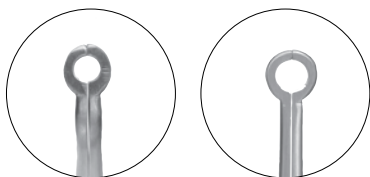

### Cooley Vena Cava Catheter Clamp

jaw working length 45mm

Catalog #	Description
320-560	Child size, 6½" (165mm), 24FR
320-562	Child size, 7½" (190mm), 26FR
320-564	Adult size, 7½" (190mm), 28FR
320-566	Adult size, 7½" (190mm), 30FR
320-568	Adult size, 7½" (190mm), 32FR
320-570	Adult size, 7½" (190mm), 34FR
320-572	Adult size, 7½" (190mm), 36FR

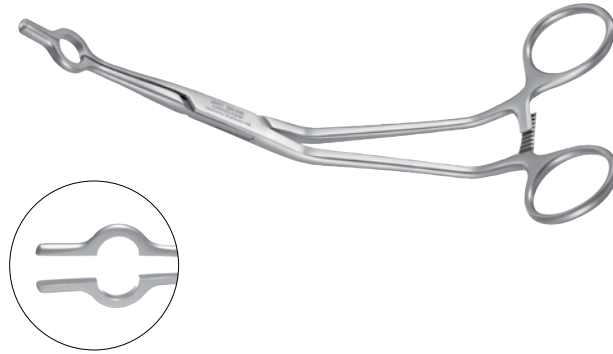

### Tube Occluding Forceps Delicate

Catalog #	Description
110-150	6½" (165mm)



### Tube Occluding Forceps Delicate

Catalog #	Description
110-154	5¾" (145mm), beveled edges, delicate jaws with smooth inner surfaces



### Vorse Tube Occluding Forceps

Catalog #	Description
110-155	6" (154mm)
110-157	7½" (189mm)
110-159	8" (204), heavy jaw



**Tube Occluding Forceps, with U-Shaped Guard**

Catalog #	Description
110-160	6" (154mm)
110-161	7½" (189mm)
110-162	8" (204), heavy jaw



**Glover Bulldog Clamps**

adjusting screw to regulate tension

straight, with DeBakey type jaws

Catalog #	Description
320-120	1⅞" (48mm), jaw working length 20mm, 1.8mm wide jaws
320-125	2¾" (69mm), jaw working length 30mm, 1.8mm wide jaws
320-130	3⅜" (85mm), jaw working length 45mm, 1.8mm wide jaws
320-135	5⅛" (131mm), jaw working length 60mm, 2.2mm wide jaws



### Glover Bulldog Clamps

adjusting screw to regulate tension  
curved, with DeBakey type jaws

Catalog #	Description
320-122	1¾" (45mm), jaw working length 15mm, 1.8mm wide jaws
320-127	2½" (64mm), jaw working length 25mm, 1.8mm wide jaws
320-132	3⅜" (80mm), jaw working length 35mm, 1.8mm wide jaws
320-137	4¾" (120mm), jaw working length 50mm, 2.2mm wide jaws



### Glover Bulldog Clamp

adjusting screw to regulate tension

Catalog #	Description
320-148	2" (51mm), jaw working length 31mm, 90 degree, 1.7mm wide jaws



### Cooley Bulldog Clamps

adjusting screw to regulate tension  
straight, with Cooley type jaws

Catalog #	Description
320-140	2" (51mm), jaw working length 22mm, 1.7mm wide jaws
320-142	2⅝" (69mm), jaw working length 30mm, 1.7mm wide jaws
320-144	3⅜" (86mm), jaw working length 47mm, 1.7mm wide jaws
320-146	5" (127mm), jaw working length 60mm, 2.6mm wide jaws



### Cooley Bulldog Clamps

adjusting screw to regulate tension  
curved, with Cooley type jaws

Catalog #	Description
320-141	1¾" (44mm), jaw working length 18mm, 1.6mm wide jaws
320-143	2½" (64mm), jaw working length 25mm, 1.6mm wide jaws
320-145	3" (76mm), jaw working length 35mm, 1.6mm wide jaws
320-147	4½" (114mm), jaw working length 45mm, 2.5mm wide jaws



### DeBakey Cross-Action Bulldog Clamps, 2.7kg Tension

straight, with DeBakey type jaws

Catalog #	Description
320-150	3⅛" (80mm), jaw working length 23mm, 2.9mm wide jaws
320-155	3½" (90mm), jaw working length 33mm, 2.9mm wide jaws
320-160	4⅛" (105mm), jaw working length 48mm, 2.9mm wide jaws
320-165	4¾" (120mm), jaw working length 68mm, 2.9mm wide jaws



### DeBakey Cross-Action Bulldog Clamps, 2.7kg Tension

curved, with DeBakey type jaws

Catalog #	Description
320-152	3" (75mm), jaw working length 23mm, 2.9mm wide jaws
320-157	3⅜" (85mm), jaw working length 33mm, 2.9mm wide jaws
320-162	3⅞" (100mm), jaw working length 45mm, 2.9mm wide jaws
320-167	4½" (115mm), jaw working length 68mm, 2.9mm wide jaws





### Gregory Cross-Action "soft" Bulldog Clamps

1.5kg Tension, with DeBaKey type teeth

Catalog #	Description
320-065	Right angle, short, 4¼" (107mm), jaw working length 16mm, 3.0mm wide jaws
320-179	Right angle, long, 4¾" (110mm), jaw working length 54mm, 3.0mm wide jaws
320-066	Straight, short, 3¾" (87mm), jaw working length 30mm, 2.9mm wide jaws
320-067	Straight, long, 4" (102mm), jaw working length 45mm, 2.8mm wide jaws
320-068	Curved body with right angle tip, long 4¾" (120mm), jaw working length 65mm, 2.7mm wide jaws



### Weldon Miniature Bulldog Clamps, Fine Serrated Jaws

Catalog #	Description
320-168	Straight, 1⅜" (34mm), jaw working length 14mm, 0.8mm wide jaws
320-169	Curved, 1¼" (32mm), jaw working length 13mm, 0.8mm wide jaws



**Jacobson Micro-Coronary Bulldog Clamps, Fine Serrated Jaws**

Catalog #	Description
320-177	Straight, 17/8" (48mm), jaw working length 20mm, 1.1mm wide jaws
320-178	Curved, 13/4" (44mm), jaw working length 15mm, 1.1mm wide jaws



**Diethrich Micro-Coronary Bulldog Clamps, 55gms Tension, Fine Serrated Jaws**

Catalog #	Description
320-170	13/4" (44mm), jaw working length 8mm, 1.1mm wide angled jaws
320-171	17/8" (49mm), jaw working length 8mm, 1.2mm wide straight jaws
320-172	13/4" (46mm), jaw working length 12mm, 1.2mm wide angled jaws
320-173	21/8" (53mm), jaw working length 12mm, 1.2mm wide straight jaws
320-174	17/8" (49mm), jaw working length 18mm, 1.2mm wide angled jaws
320-175	23/8" (59mm), jaw working length 18mm, 1.2mm wide straight jaws



**Diethrich Micro-Coronary Bulldog Clamps, 180kg Tension, Fine Serrated Jaws**

Catalog #	Description
320-172ST	13/4" (46mm), jaw working length 12mm, 1.2mm wide angled jaws
320-175ST	21/8" (53mm), jaw working length 12mm, 1.2mm wide straight jaws

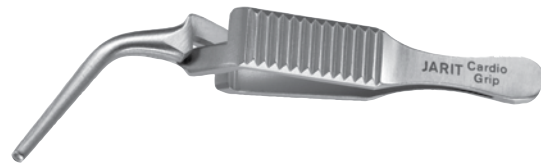

**Integra™**  
Titanium  
Instruments

**Titanium**

**Micro Clamps, Pediatric, DeBakey Serrations, Titanium**

Catalog #	Description
320-700TI	4¾" (121mm), straight shanks, jaw working length 1⅛" (28mm)



320-701TI	4⅝" (119mm), slightly angled shanks, jaw working length 1⅛" (28mm)
-----------	--



320-702TI	4⅜" (110mm), angled shanks, jaw working length ⅞" (22mm)
-----------	--



320-708TI	4⅜" (110mm), acutely angled shanks, jaw working length 1⅛" (30mm)
-----------	---



Titanium

**Micro Clamps, Pediatric, DeBakey Serrations. Titanium**

Catalog #	Description
320-703TI	4 <sup>3</sup> / <sub>8</sub> " (110mm), straight shanks, 45° angled jaw, jaw working length 1" (25mm)



320-709TI	4 <sup>1</sup> / <sub>2</sub> " (114mm), straight shanks, 45° angled jaw, jaw working length 1 <sup>1</sup> / <sub>8</sub> " (30mm)
-----------	---



320-704TI	4" (102mm), straight shanks, 60° angled jaw, jaw working length 7 <sup>7</sup> / <sub>8</sub> " (23mm)
-----------	--



320-710TI	4 <sup>3</sup> / <sub>8</sub> " (110mm), straight shanks, 60° angled jaw, jaw working length 1 <sup>1</sup> / <sub>8</sub> " (30mm)
-----------	---



**Titanium**

**Micro Clamps, Pediatric, DeBakey Serrations, Titanium**

Catalog #	Description
320-706TI	4 1/8" (105mm), straight shanks, jaw working length 1/2" (14mm), jaw depth 1/4" (4mm)



320-705TI	4 1/8" (105mm), slightly angled shanks, jaw working length 1/2" (14mm), jaw depth 1/4" (6mm)
-----------	--



320-711TI	4 3/8" (112mm), slightly angled shanks, jaw working length 7/8" (22mm), jaw depth 1/4" (6mm)
-----------	--



Titanium

**Micro Clamps, Pediatric, DeBakey Serrations, Titanium**

Catalog #	Description
320-707TI	4 1/8" (105mm), slightly angled shanks, jaw working length 5/8" (16mm), jaw depth 3/8" (5mm)



320-712TI	4 3/8" (112mm), slightly angled shanks, jaw working length 7/16" (11mm), jaw depth 3/8" (4mm)
-----------	---



320-713TI	4 5/8" (118mm), straight shanks, spoon-shaped, jaw working length 1/2" (13mm), jaw depth 1/4" (4mm)
-----------	---



**Titanium**

**Kitzmiller Micro Clamps, DeBakey Serrations, Titanium**

Catalog #	Description
320-540TI	4 1/4" (108mm), left angled, jaw working length 5 1/6" (8mm)
320-542TI	4 1/4" (108mm), right angled, jaw working length 5 1/6" (8mm)



Right



Left



**Lambert-Kay Aorta Clamp, Titanium**

for abdominal and thoracic surgery

Catalog #	Description
320-728TI	7 3/4" (200mm), jaw working length 1 7/8" (48mm), jaw depth 7/8" (23mm)





**Titanium**
**Jarit Stardust® Needle Holders**

Unique metallurgical process bonds tungsten carbide particles to the jaws. Extra hardness assures durability and firm grip without damaging needles.

**Microvascular Needle Holders, Titanium, Stardust**

straight, for use with 3.0, 4.0, and 5.0 suture

Catalog #	Description
124-100TI	7¼" (185mm)
124-101TI	8¾" (220mm)
124-102TI	9¾" (250mm)

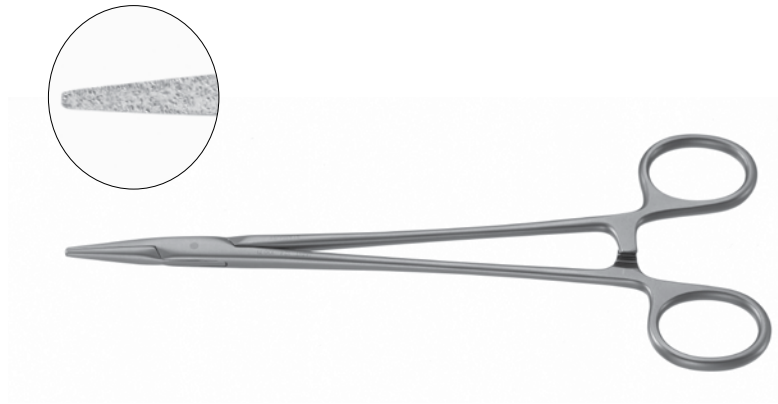
**Richards Micro Needle Holders, Titanium, Stardust**

extra fine, straight, 1mm tips, for use with 5.0, 6.0, and 7.0 suture

Catalog #	Description
124-105TI	6¼" (156mm)
124-106TI	7" (178mm)



**Titanium**

**Ryder Needle Holders, Titanium, Stardust**  
straight, 1.5mm tips, for use with 5.0 and 6.0 suture

Catalog #	Description
124-108TI	6 1/4" (157mm)
124-109TI	7" (175mm)
124-110TI	7 3/4" (195mm)

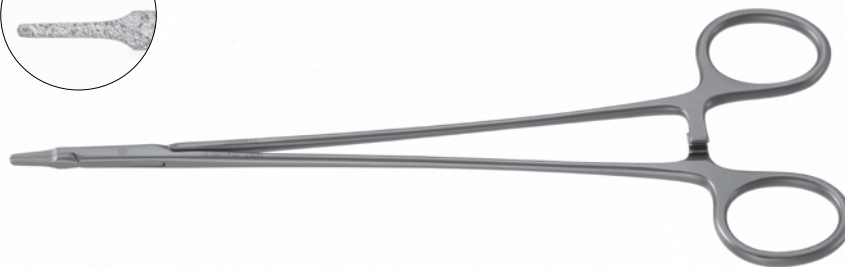
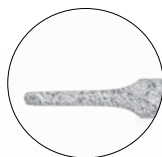

**Ryder Needle Holders, Titanium, Carb-Bite**  
straight, 1.7mm tips, for use with 4.0, 5.0, and 6.0 suture

Catalog #	Description
121-161TI	6 1/4" (157mm)
121-162TI	7" (175mm)
121-163TI	7 3/4" (195mm)

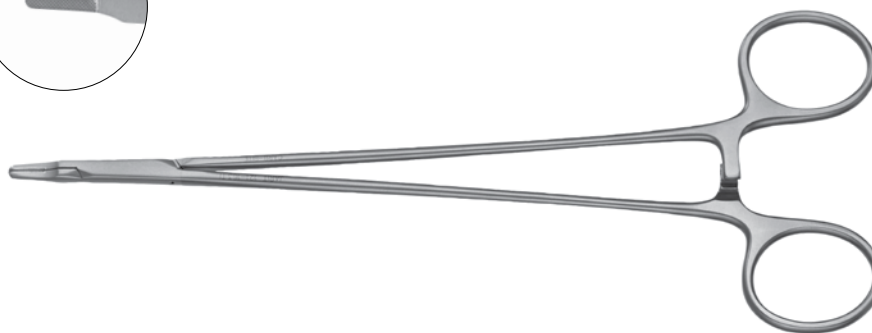
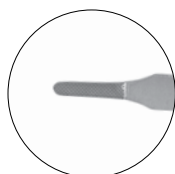

**Titanium**

**DeBakey Forceps, Round Handle, Titanium**  
straight, 1.8mm tips

Catalog #	Description
320-111TI	7 1/8" (181mm)

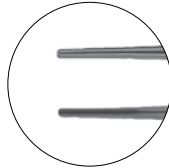

**DeBakey Forceps, Titanium**  
straight, 2.5mm tips

Catalog #	Description
320-084TI	7 3/4" (197mm)
320-085TI	9 1/2" (241mm)

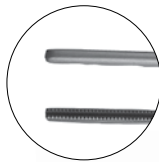

**DeBakey Forceps, Titanium**  
straight, 2.5mm tips

Catalog #	Description
320-083TI	6" (150mm)

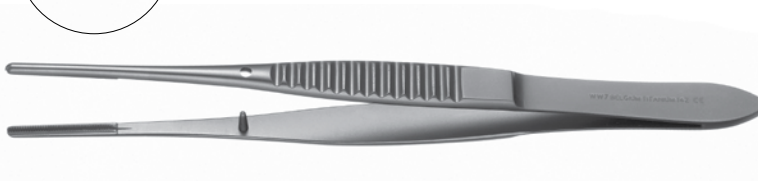
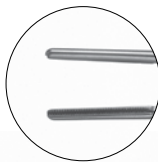

**Cushing Tissue Forceps, Titanium**  
sharp dissecting end, Gutsch handle  
straight, delicate, 1.2mm serrated tips

Catalog #	Description
130-425TI	7" (176mm), delicate 1.2mm serrated tips

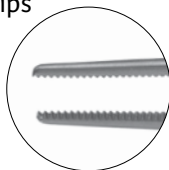

**Titanium**

**Jarit Micro Stardust Needle Holder, Titanium, Flat Handle, Low Profile Box Lock**

0.8mm micro tip

Catalog #	Description
278-080TI	7" (180mm), flat handles, straight jaws, with catch
278-082TI	8 1/4" (210mm), flat handles, straight jaws, with catch



**Jarit Micro Stardust Needle Holder, Titanium, Round Handle, Low Profile Box Lock**

0.7mm micro tip

Catalog #	Description
278-141TI	4 3/4" (120mm), straight jaws, with catch
278-093TI	7" (180mm), straight jaws, with catch
278-095TI	7 3/4" (200mm), straight jaws, with catch
278-097TI	10" (255mm), straight jaws, with catch
278-140TI	4 3/4" (120mm), straight jaws, without catch
278-142TI	4 3/4" (120mm), curved jaws, without catch



**Jarit Micro Stardust Needle Holder, Titanium, Round Handle, Low Profile Box Lock**

0.8mm micro tip

Catalog #	Description
278-108TI	5 7/8" (148mm), straight jaws, with catch
278-111TI	7" (178mm), straight jaws, with catch
278-113TI	7 3/4" (200mm), straight jaws, with catch

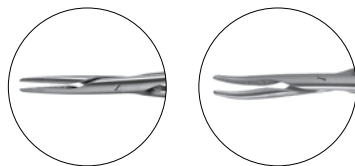

**Titanium**

**Jarit Micro Stardust Needle Holder, Titanium**

round handle, with catch, low profile box lock, delicate 1.2mm tip

Catalog #	Description
278-143TI	4¾" (120mm), curved jaws
278-145TI	5⅞" (148mm), straight jaws
278-147TI	5⅞" (148mm), curved jaws,
278-069TI	7" (178mm), straight jaws
278-071TI	7" (178mm), curved jaws
278-078TI	7¾" (200mm), curved jaws

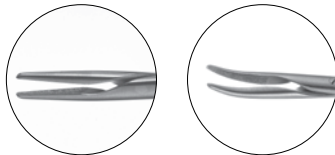

**Jarit Micro Stardust Needle Holder, Titanium**

round handle, without catch, low profile box lock, delicate 1.2mm tip

Catalog #	Description
278-144TI	5⅞" (148mm), straight jaws
278-146TI	5⅞" (148mm), curved jaws
278-070TI	7" (178mm), straight jaws,
278-072TI	7" (178mm), curved jaws
278-077TI	7¾" (200mm), straight jaws
278-079TI	7¾" (200mm), curved jaws

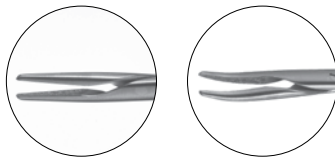

**Jacobson Stardust Needle Holder, Titanium**

round handle, low profile box lock, heavy style, 2mm tip

Catalog #	Description
278-171TI	7½" (190mm), straight jaws, with catch
278-172TI	5⅞" (148mm), curved jaws, with catch
278-173TI	7" (178mm), straight jaws, without catch
278-174TI	7" (178mm), curved jaws, without catch

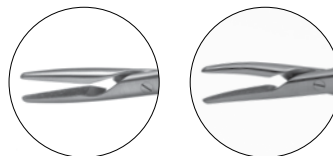

**Titanium**

**DeBakey-Dietrich Coronary Artery Forceps, Titanium**

round handle, delicate 1.2mm tips

Catalog #	Description
320-113TI	6 1/8" (156mm)
320-114TI	7 1/8" (180mm)
320-115TI	8 1/4" (210mm)

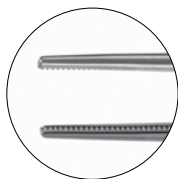

**DeBakey Forceps, Titanium**

flat handle, 1.5mm tips

Catalog #	Description
320-080TI	6" (150mm)
320-081TI	7 3/4" (195mm)
320-082TI	9 1/2" (241mm)

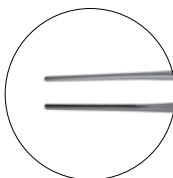

**Dennis Micro Ring Forceps, Titanium**

with contour balance, round handle, straight, 1mm Stardust tips

Catalog #	Description
279-110TI	7 1/4" (181mm)
279-111TI	8 1/8" (210mm)
279-112TI	9 1/8" (229mm)

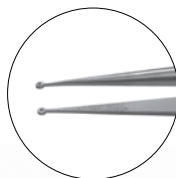

Titanium

**Bailey-Finochietto Pediatric Rib Spreader, Titanium**

Catalog #	Description
320-517TI	Spread: 2¾" (70mm), Arm length: 2⅜" (60mm) Blades: ⅝" x ¾" deep (16mm x 20mm)



**Titanium**

**Rhoton-Type Dissectors, Titanium**

round, 7½" (190mm)

Catalog #	Description
277-260TI	1mm blade, #1
277-261TI	2mm blade, #2
277-262TI	3mm blade, #3



**Rhoton-Type Elevators, Titanium**

7½" (190mm)

Catalog #	Description
277-263TI	Curved, #4
277-264TI	Angled, #5



**Rhoton-Type Spatula Dissectors, Titanium**

7½" (190mm)

Catalog #	Description
277-265TI	Small, #6
277-266TI	Medium, #7
277-267TI	Large, #8



**Rhoton-Type Hooks, Titanium**

7½" (190mm)

Catalog #	Description
277-268TI	90° angle, semi-sharp, #9
277-269TI	90° angle, blunt, #10
277-270TI	45° angle, semi-sharp, #11



**Rhoton-Type Needle, Titanium**

7½" (190mm)

Catalog #	Description
277-271TI	Straight, #12





**Titanium**

**Rhoton-Type Currettes, Titanium**

7½" (190mm)

Catalog #	Description
277-272TI	Straight, #13
277-273TI	Angled, #14



**Rhoton-Type Ball-Dissectors, Titanium**

7½" (190mm)

Catalog #	Description
277-274TI	90° angle, 3mm, #15
277-276TI	Straight, #16
277-277TI	90° angle, 5mm, #17
277-278TI	40° angle, 4mm, #18
277-279TI	40° angle, 8mm, #19



**Rhoton-Type Instrument Rack**

Catalog #	Description
277-275TI	For 19 stainless steel or titanium instruments, 277-260TI through 277-279TI, 10" x 8¾" x 1" (255mm x 223mm x 25mm)

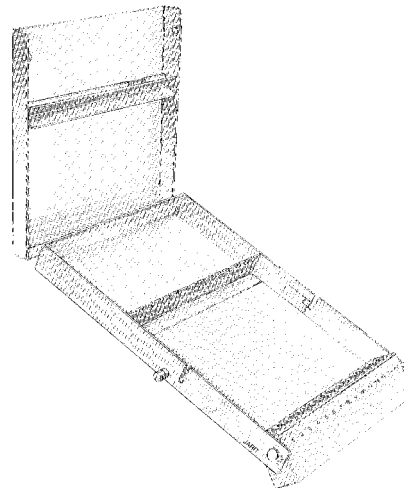

**Titanium**

**Jarit Micro Stardust Needle Holder, Titanium**  
flat handles, low profile box lock, 0.8mm micro tip

Catalog #	Description
278-080TI	7" (180mm), straight jaws, with catch
278-082TI	8¼" (210mm), straight jaws, with catch



**Jarit Micro Stardust Needle Holder, Titanium**  
round handles, low profile box lock, 0.8mm micro tip

Catalog #	Description
278-093TI	7" (180mm), straight jaws, with catch
278-095TI	7¾" (200mm), straight jaws, with catch
278-097TI	10" (255mm), straight jaws, with catch



**Jarit Micro Stardust Needle Holder, Titanium**  
round handles, low profile box lock, 0.8mm micro tip

Catalog #	Description
278-108TI	5⅞" (148mm), straight jaws, with catch
278-111TI	7" (178mm), straight jaws, with catch
278-113TI	7¾" (200mm), straight jaws, with catch



**Titanium**

**Jarit Stardust® Micro Suture Forceps**

A matched set of forceps designed for tissue manipulation and needle guide. Unique metallurgical process bonds tungsten carbide particles to the jaws. Extra hardness assures durability and firm grip without damaging needles.

**Jarit Micro Forceps, Titanium, Round Handle, Stardust Platform Tips**

Catalog #	Description
279-093TI	7¼" (184mm), straight
279-094TI	7¼" (184mm), curved
279-097TI	8¼" (210mm), straight
279-098TI	10" (254mm), straight

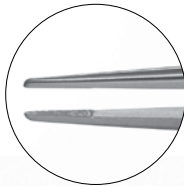

**Jarit Micro Ring Forceps, Titanium, Stardust Tips**

Catalog #	Description
279-083TI	6" (152mm), 1mm ring tips
279-088TI	6" (152mm), 2mm ring tips
279-084TI	7⅞" (181mm), 1mm ring tips
279-089TI	7⅞" (181mm), 2mm ring tips

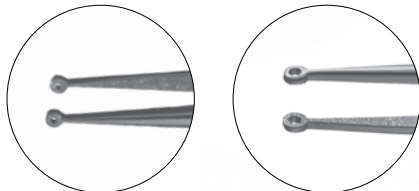

**Titanium**

**Gerald Stardust Forceps, Titanium, Delicate 0.8mm Platform Tips**

Catalog #	Description
279-150TI	7" (178mm)
279-151TI	8" (203mm)



**Gerald Forceps, Titanium**  
delicate 1mm DeBakey tips

Catalog #	Description
285-131TI	7" (180mm)
285-132TI	8 1/4" (210mm)

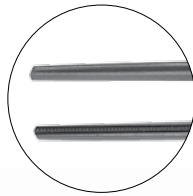

**Cushing Tissue Forceps, Titanium, Semi-Sharp Dissecting End, Gutsch Handle**

Catalog #	Description
130-425TI	7" (176mm), delicate 1.2mm serrated tips

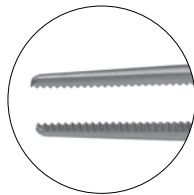

**Titanium**

**Jarit Stardust Micro Suture Forceps, Titanium**  
tungsten carbide coated, round handles with counter-balance

straight,  
with tying platform

Catalog #	Description
279-100TI	7¼" (184mm)
279-101TI	8¼" (210mm)
279-102TI	9" (229mm)



micro ring,  
(1.0mm OD x 0.5mm ID)

Catalog #	Description
279-110TI	7¼" (181mm)
279-111TI	8¼" (210mm)
279-112TI	9" (229mm)



**Titanium**

**Jewelers Style Forceps**  
style 1: fine

Catalog #	Description
355-170TI	4 <sup>3</sup> / <sub>4</sub> " (120mm)

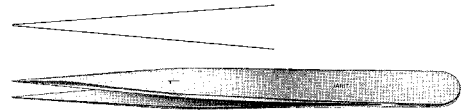

**Jewelers Style Forceps**  
style 3: very fine

Catalog #	Description
355-171TI	4 <sup>3</sup> / <sub>4</sub> " (120mm)



**Jewelers Style Forceps**  
style 7: very fine, curved

Catalog #	Description
355-175TI	4 <sup>5</sup> / <sub>8</sub> " (118mm)

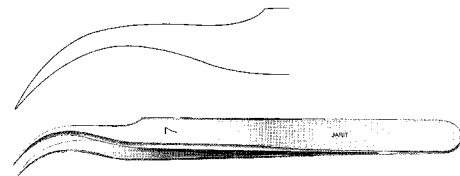

**Integra™**  
Ophthalmic  
Instruments and  
General Surgical  
Instruments

**McPherson Eye Speculum**

3 1/8" (80mm)

Catalog #	Description
350-090	14mm blades, 45mm spread

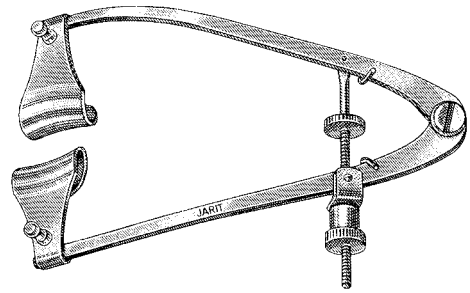

**Barraquer Eye Specula**

solid blades

Catalog #	Description
350-092	1 1/2" (37mm), 11mm blades, 18mm spread, pediatric size
350-093	1 5/8" (40mm), 14mm blades, 20mm spread

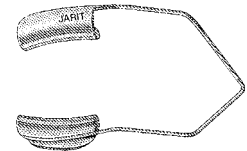

**Barraquer Eye Specula**

open wire blades

Catalog #	Description
350-094	1 1/8" (30mm), 9mm blades, 15mm spread, pediatric size
350-095	1 5/8" (40mm), 14mm blades, 18mm spread

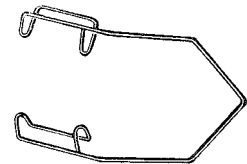

**Kratz-Barraquer Eye Speculum**

1 5/8" (42mm), open wire blades

Catalog #	Description
350-096	15mm blades, 18mm spread

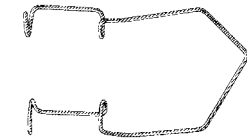

**Sauer Eye Speculum, Infant**

1 1/4" (31mm)

Catalog #	Description
350-097	11mm blades, 20mm spread

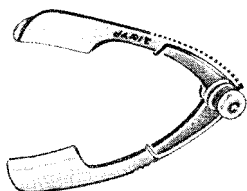



**Alfonso Eye Speculum, Newborn**

1¾" (44mm)

Catalog #	Description
350-098	5mm blades, 27mm spread

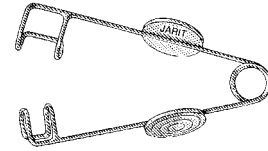

**Williams Eye Specula**

Catalog #	Description
350-100	2⅝" (67mm), 11mm blades, 26mm spread
350-101	3⅛" (79mm), 15mm blades, 32mm spread

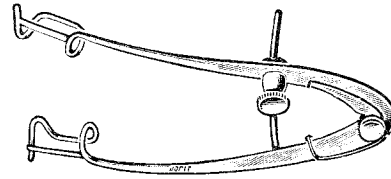

**Lancaster Eye Speculum**

3⅛" (79mm)

Catalog #	Description
350-105	15mm blades, 32mm spread

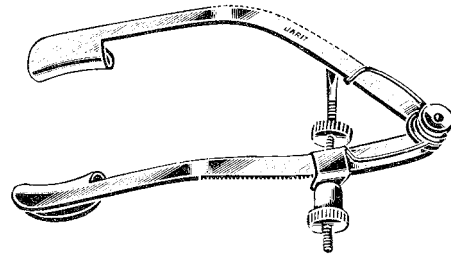

**Wiener Eye Speculum**

2" (50mm)

Catalog #	Description
350-110	14mm blades, 25mm spread

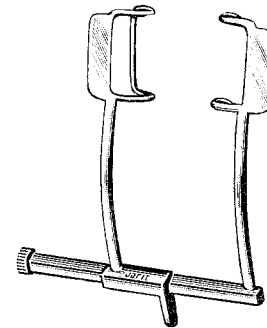

**Cook Eye Speculum, Infant**

1½" (37mm)

Catalog #	Description
350-112	with locking screw, 7.5mm blades, 21mm spread

350-TSC-112 Replacement Thumb Screw pkg/2ea

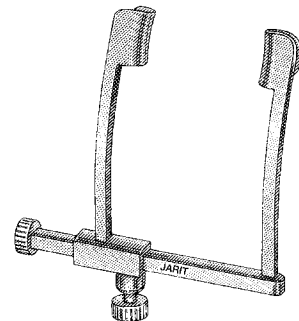

**Maumenee-Park Eye Speculum**

3 7/8" (80mm)

Catalog #	Description
350-118	Fenestrated blades and canthus bar, 14.5mm blades, 43mm spread

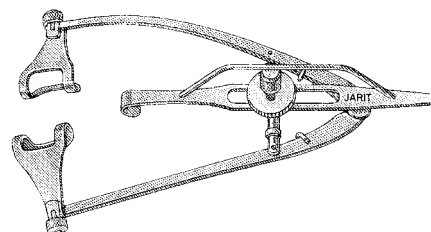

**Maumenee-Park Eye Speculum**

3 7/8" (80mm)

Catalog #	Description
350-119	Fenestrated blades and canthus bar, 14.5mm blades, 40mm spread

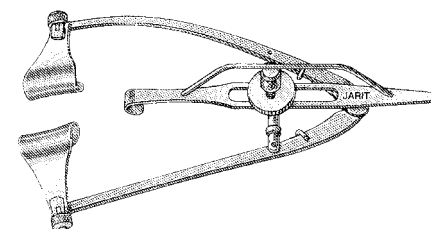

**Park-Guyton Eye Speculum**

3 7/8" (80mm)

Catalog #	Description
350-120	Fenestrated blades and canthus bar, 14mm blades, 43mm spread

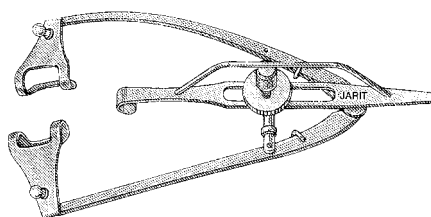

**Park-Guyton Eye Speculum**

3 7/8" (80mm)

Catalog #	Description
350-121	Solid blades and canthus bar, 14.5mm blades, 40mm spread

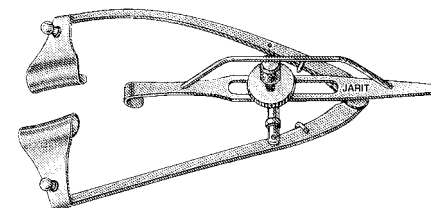

**Castroviejo Eye Specula**

3 5/8" (92mm)

Catalog #	Description
350-125	13.5mm blades, 34mm spread
350-126	15.5mm blades, 35mm spread

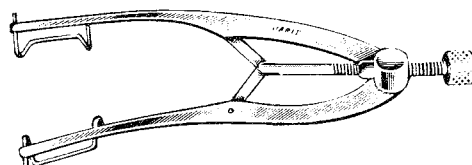

**Stevenson Lacrimal Sac Retractor**

Catalog #	Description
350-140	3mm deep semi-sharp prongs, 20mm spread

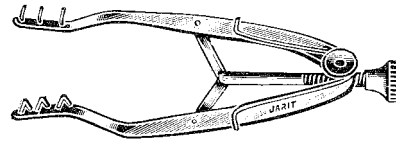

**Agricola Lacrimal Sac Retractor**

Catalog #	Description
350-142	4mm deep sharp prongs, 30mm spread

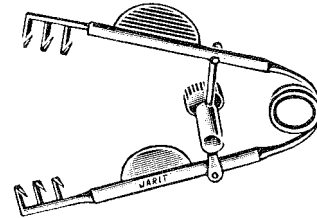

**Goldstein Lacrimal Sac Retractor**

Catalog #	Description
350-144	4mm deep sharp prongs, 17mm spread

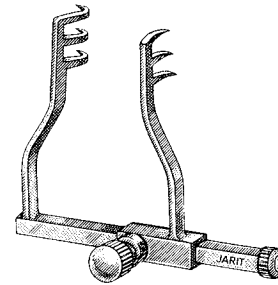

**Desmarres Lid Retractors**

5 1/2" (140mm)

Catalog #	Description
350-149	Size 0: 10mm
350-150	Size 1: 12mm
350-151	Size 2: 14mm
350-152	Size 3: 16mm
350-153	Size 4: 18mm

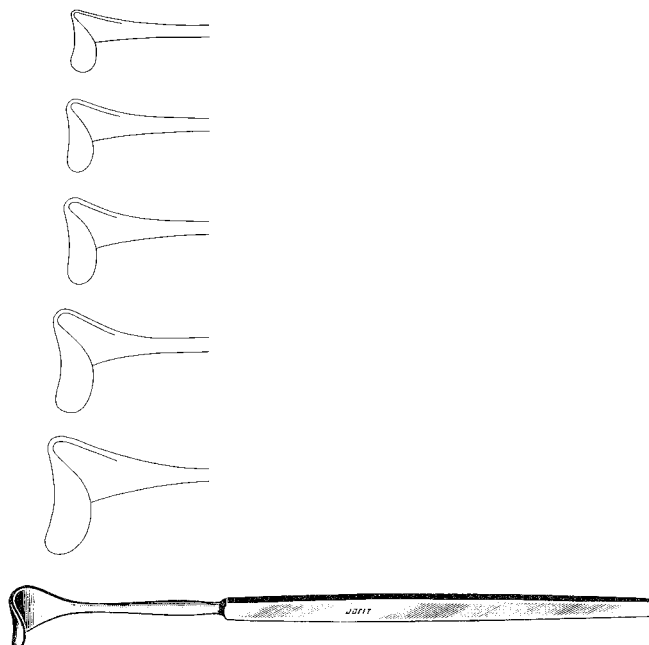

**Jaffe Lid Retractor**

1<sup>5</sup>/<sub>8</sub>" (40mm), pair

Catalog #	Description
350-155	15mm wide curved blades



**Schepens Orbital Retractor**

6" (150mm)

Catalog #	Description
350-160	14mm wide x 60mm blade

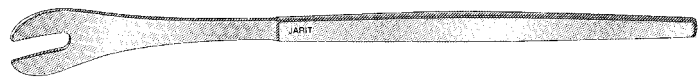

**Wheeler Discission Knife**

4<sup>1</sup>/<sub>2</sub>" (114mm)

Catalog #	Description
350-210	1.3mm x 18mm blade



**Paufique Garft Knife**

4<sup>1</sup>/<sub>8</sub>" (105mm)

Catalog #	Description
350-250	1.6mm x 1.75mm angled blade

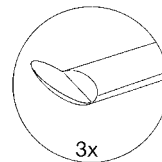

**Gill Corneal Knives**

4<sup>3</sup>/<sub>4</sub>" (120mm), 3.3mm x 8mm blade

Catalog #	Description
350-255	Straight
350-256	Curved

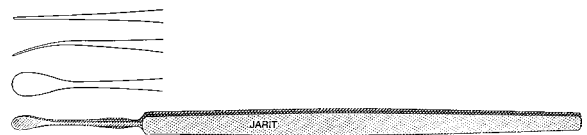

**Tooke Corneal Knife**

4<sup>1</sup>/<sub>2</sub>" (115mm)

Catalog #	Description
350-260	3mm x 18mm blade



**Castroviejo Blade Breaker and Holder**

5 1/8" (130mm)

Catalog #	Description
350-290	12mm smooth jaws, round knurled handle with end lock

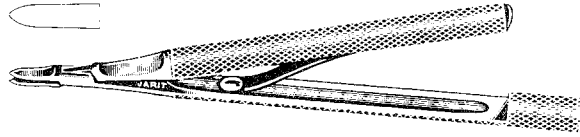

**Barraquer Blade Breaker and Holder**

4 3/8" (110mm)

Catalog #	Description
350-292	12mm smooth jaws, flat grooved handle with spring lock

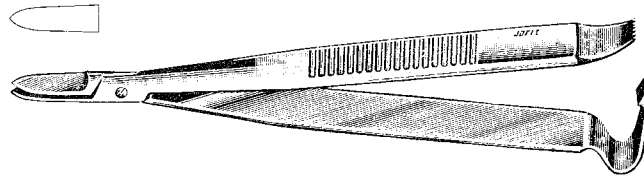

**Castroviejo Blade Breaker and Holder**

5 5/8" (143mm)

Catalog #	Description
350-294	12mm Stardust jaws, round knurled handle with slide lock

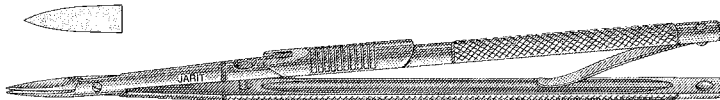

**Meyhoeffer Chalazion Currettes**

5" (127mm)

Catalog #	Description
350-300	Size 3-0: 0.5mm diameter
350-301	Size 2-0: 1mm diameter
350-302	Size 0: 1.5mm diameter
350-303	Size 1: 2mm diameter
350-304	Size 2: 2.5mm diameter
350-305	Size 3: 3mm diameter

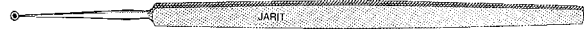

**Gills-Welsh Curette Capsule Polisher**

5 1/8" (130mm)

Catalog #	Description
350-310	2mm cup, 45° angled shaft, 8mm from tip to bend



**Dix Foreign Body Spud**

4 3/4" (121mm)

Catalog #	Description
350-320	Blade 2.3mm wide x 16mm long

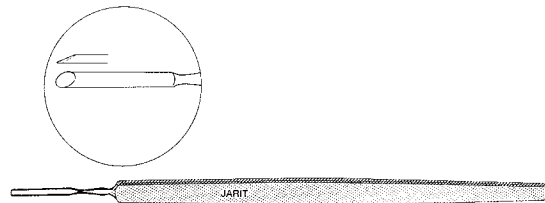

**Francis Foreign Body Spud**

4 5/8" (117mm)

Catalog #	Description
350-321	Blade 1.1mm wide x 1.3mm long

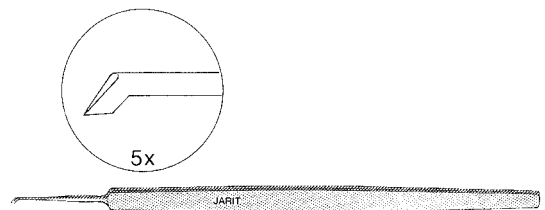

**La Force Foreign Body Spud**

Catalog #	Description
350-322	4¾" (120mm)

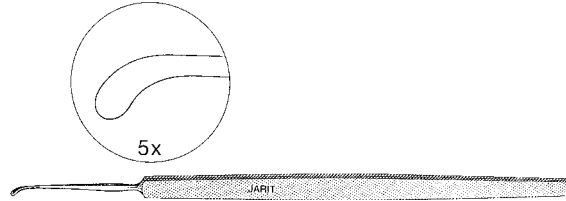

**Foreign Body Spud  
w/ spear point**

Catalog #	Description
350-325	4⅞" (124mm), 2.5mm, curved blade

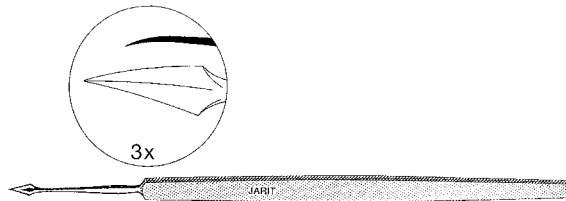

**Magnetic Eye Probe  
w/ foreign body loop**

Catalog #	Description
350-330	4¾" (120mm)

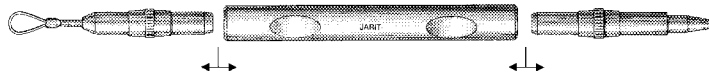

**Fixation Hooks**

5" (127mm), 2 sharp prongs

Catalog #	Description
350-340	1.5mm spread between tips
350-341	2.0mm spread between tips

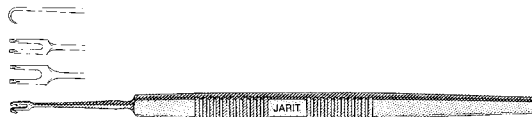

**Tyrell Hooks**

4¾" (120mm), 2mm

Catalog #	Description
350-344	Sharp
350-345	Blunt

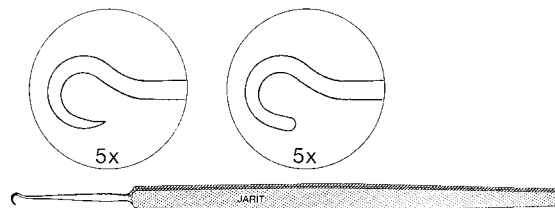

**Shepard Iris Hook**

4⅞" (124mm)

Catalog #	Description
350-347	1mm, blunt

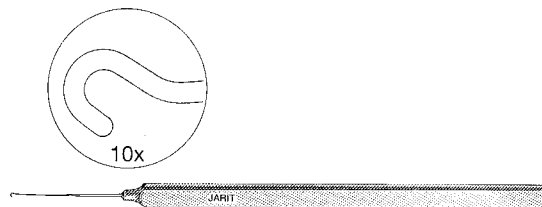

**Bonn Iris Hook**

4⅞" (124mm)

Catalog #	Description
350-348	0.3mm, blunt

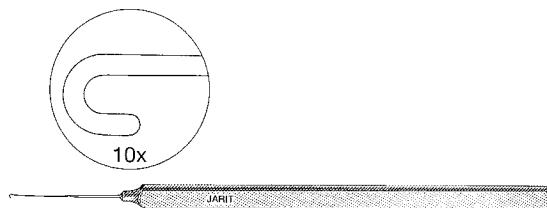

**Hirschman Iris Hook**

4¾" (121mm)

Catalog #	Description
350-349	0.75mm hook, 45° angled shaft, 9mm from tip to bend

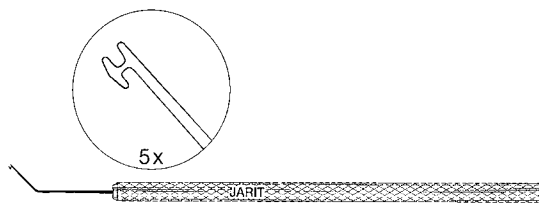



**Von Graefe Strabismus Hooks**

5½" (140mm)

Catalog #	Description
350-350	Size 1: 7.8mm hook
350-351	Size 2: 9.5mm hook
350-352	Size 3: 11.5mm hook

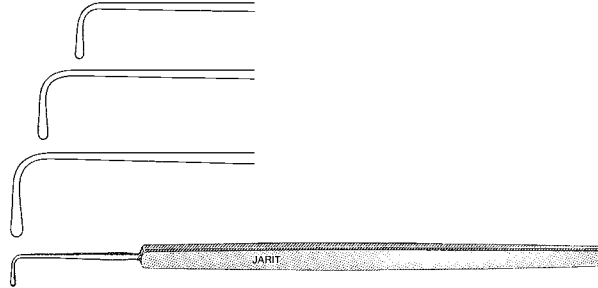

**Jameson Muscle Hooks**

5" (127mm)

Catalog #	Description
350-353	8mm hook, 1.4mm tip

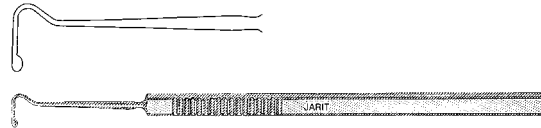

**Jameson Muscle Hooks**

5¼" (127mm)

Catalog #	Description
350-354	11mm hook, 1.8mm tip

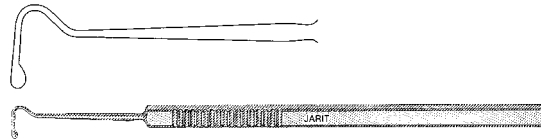

**Stevens Tenotomy Hook**

4⅞" (124mm)

Catalog #	Description
350-355	6mm hook

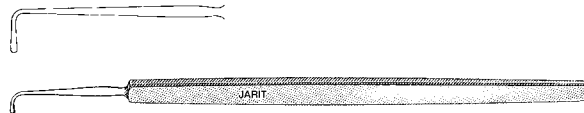

**Green Strabismus Hook**

5⅛" (130mm)

Catalog #	Description
350-357	10mm hook

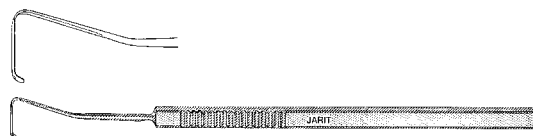

**O'Connor Hook**

4 7/8" (124mm)

Catalog #	Description
350-360	4.5mm hook

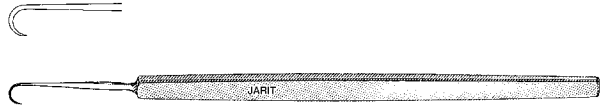

**Clayman Iris Hook**

4 5/8" (117mm)

Catalog #	Description
350-362	0.3mm hook, 45° angled shaft, 9mm from tip to bend

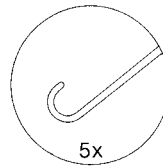

**Clayman Iris Hook**

4 1/2" (114mm)

Catalog #	Description
350-363	0.2mm hook, 45° angled shaft, 10mm from tip to bend

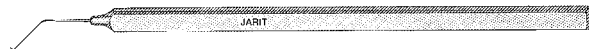
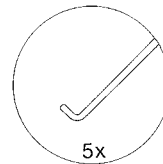

**Sinskey Iris and I.O.L. Hook**

4 1/2" (114mm)

Catalog #	Description
350-365	0.2mm hook

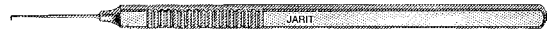
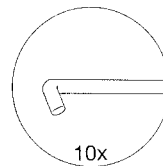

**Sinskey Modified Hook**

4 3/4" (121mm)

Catalog #	Description
350-366	0.2mm hook, curved shaft

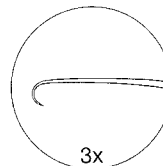

**Knolle Iris Hook**

4 7/8" (124mm)

Catalog #	Description
350-368	0.5mm hook

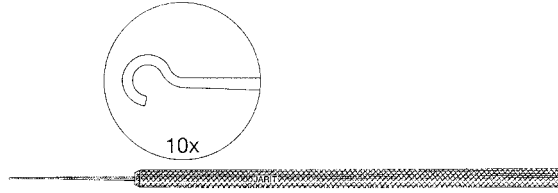

**Kuglen Iris Hook and Lens Manipulator**

4 5/8" (117mm)

Catalog #	Description
350-369	0.5mm "K" hook

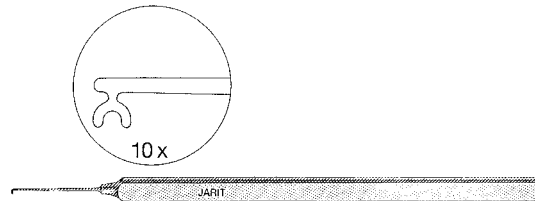

**Guthrie Fixation Hooks**

Catalog #	Description
350-370	4 3/4" (120mm), 1.5mm spread between the tips
350-371	5" (127mm), 2.5mm spread between the tips

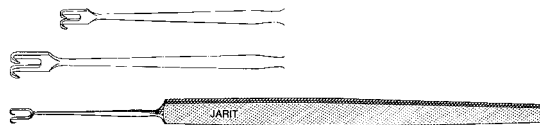

**Gass Retinal Detachment Hook**

5 3/4" (146mm)

Catalog #	Description
350-372	13mm hook

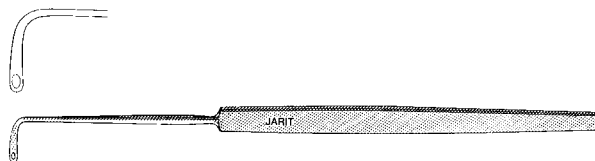

**Burch Fixation Pick**

5" (127mm)

Catalog #	Description
350-377	3mm spread between points

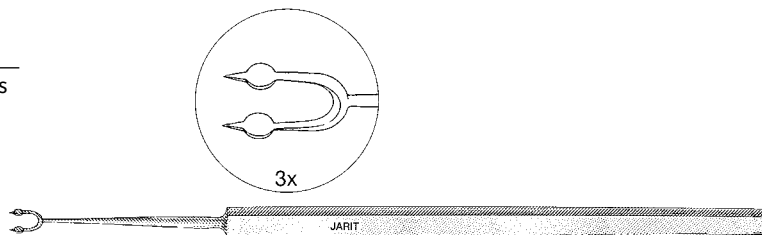

**Scleral Twist Fixation Hooks**

4 1/4" (109mm), 1mm tips

Catalog #	Description
350-380	Right
350-381	Left

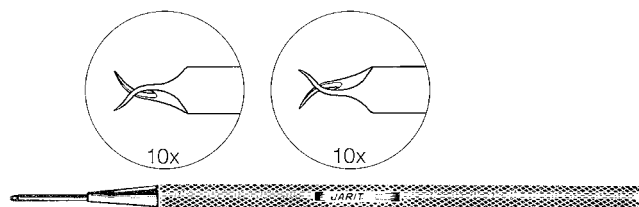

**Barraquer Iris Spatula**

4 1/2" (114mm)

Catalog #	Description
350-383	0.25mm x 15mm angled blade

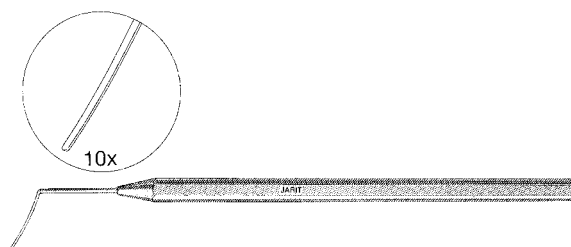

**Knolle Lens Nucleus Spatula and Gauge**

5" (127mm)

Catalog #	Description
350-384	30mm blade, with markings at 5mm, 6mm, and 7mm from tip

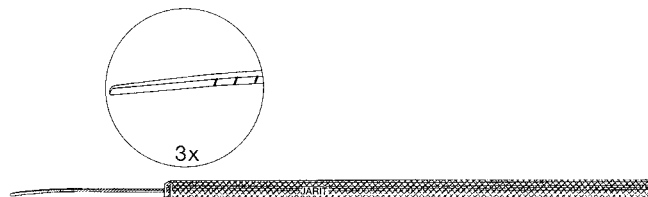

**Hirschman Iris Lens Spatula**

4 7/8" (124mm)

Catalog #	Description
350-385	10mm angled blade, notched on sides and tip

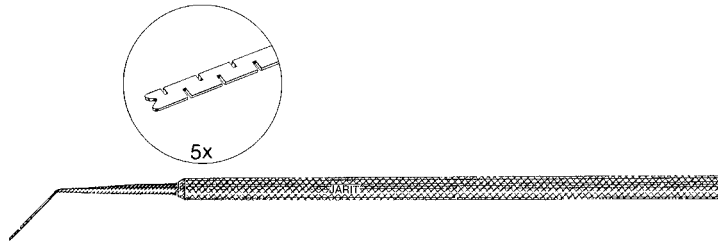

**Kimura Platinum Spatula**

5 7/8" (149mm)

Catalog #	Description
350-387	3.5mm wide x 30mm long blade



**Wheeler Cyclodialysis Spatula**

5 1/4" (134mm)

Catalog #	Description
350-390	Double ended, silver, 2mm x 22mm blades



**Castroviejo Cyclodialysis Spatula**

5" (127mm)

Catalog #	Description
350-392	Double ended, 0.5mm x 10mm and 15mm blades

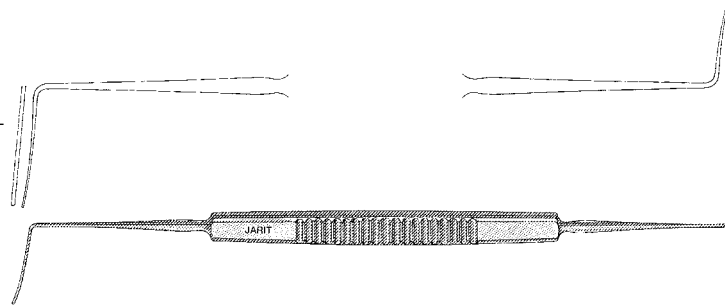

**Wecker Iris Spatula**

5 1/8" (129mm)

Catalog #	Description
350-395	Malleable, silver, 2.6mm x 30mm blade



**Barraquer Cyclodialysis Spatula**

4 3/4" (120mm)

Catalog #	Description
350-397	0.5mm x 15mm angled blade, round knurled handle

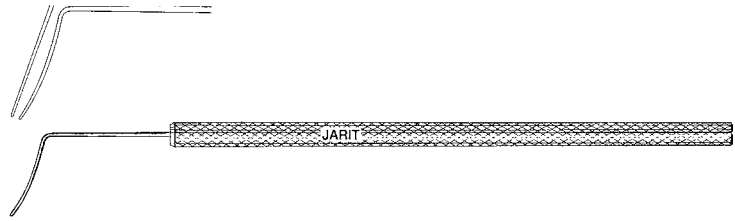

**Barraquer Iris Spatula**

3 1/2" (90mm)

Catalog #	Description
350-398	0.5mm x 15mm angled blade, hexagonal handle

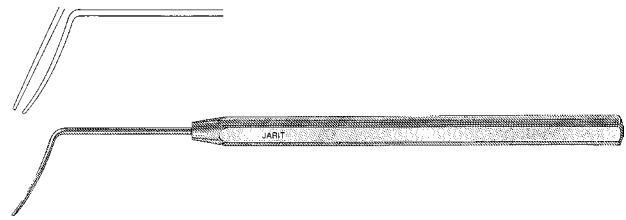

**Castroviejo Synechia Spatula**

5" (127mm)

Catalog #	Description
350-400	Double ended, 0.5mm x 10mm and 15mm blades

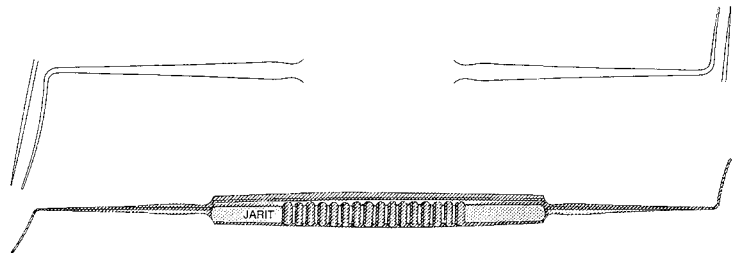

**Culler Iris Spatula**

5" (127mm)

Catalog #	Description
350-405	Sterling silver blade, 1mm x 28mm

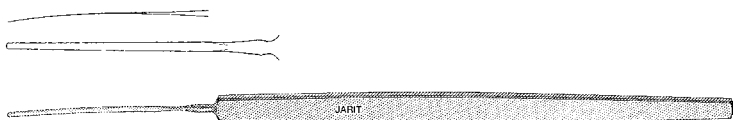

**Bechert Nucleus Rotator**

4 1/2" (113mm)

Catalog #	Description
350-410	"Y" shape tip, shaft angled 7mm from tip to bend

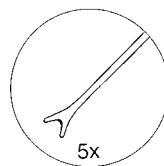

**Lewis Lens Loop**

5½" (140mm)

Catalog #	Description
350-415	6mm wide x 7mm loop

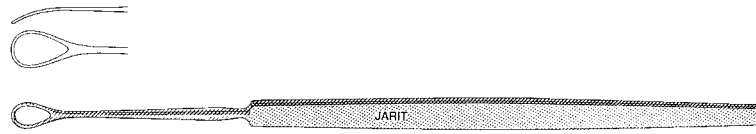

**New Orleans Lens Loop**

5½" (140mm)

Catalog #	Description
350-420	5mm wide x 10mm loop

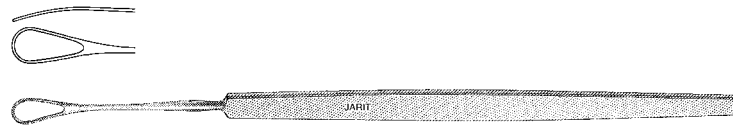

**Wilder Lens Loop**

5½" (140mm)

Catalog #	Description
350-425	4mm wide x 15mm loop, serrated

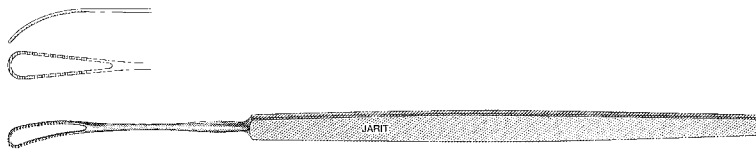

**Gills-Welsh Lens Loop**

4¾" (121mm)

Catalog #	Description
350-430	Double-ended, 5mm wide x 7mm loop, olive tip on opposite end

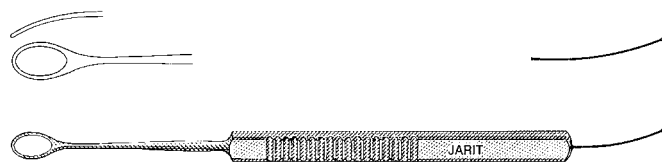

**Simcoe Nucleus Loop**

5½" (140mm)

Catalog #	Description
350-435	Double-ended, 4mm wide x 13mm left and right loops, serrated

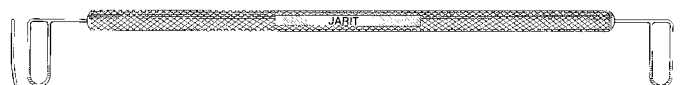

**Bunge Evisceration Spoon**

5 7/16" (138mm)

Catalog #	Description
350-440	Large, 12mm diameter

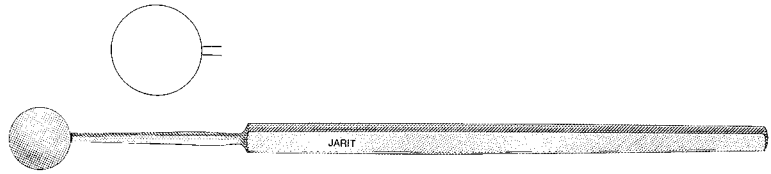

**Bunge Evisceration Spoon**

5 1/4" (132mm)

Catalog #	Description
350-441	Small, 8mm diameter

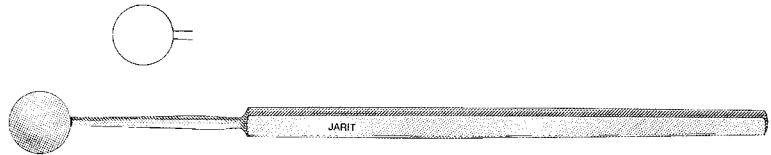

**Wells Enucleation Spoon**

5 3/4" (145mm)

Catalog #	Description
350-445	21mm wide

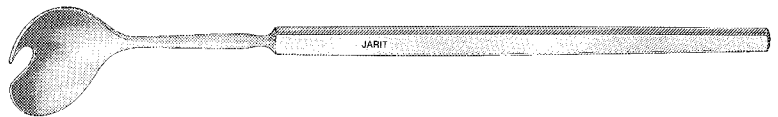



**Eye Dressing Forceps**

3<sup>7</sup>/<sub>8</sub>" (99mm)

Catalog #	Description
355-090	Delicate, serrated, straight, 0.5mm wide at tip

**Eye Dressing Forceps**

3<sup>7</sup>/<sub>8</sub>" (99mm)

Catalog #	Description
355-100	Serrated, straight, 0.8mm wide at tip

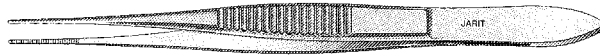

**Eye Dressing Forceps**

3<sup>7</sup>/<sub>8</sub>" (99mm)

Catalog #	Description
355-091	Delicate, serrated, half curved, 0.5mm wide at tip

**Eye Dressing Forceps**

3<sup>7</sup>/<sub>8</sub>" (99mm)

Catalog #	Description
355-101	Serrated, half curved, 0.8mm wide at tip

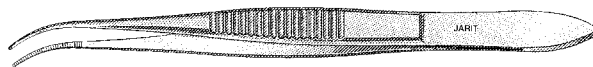

**Eye Dressing Forceps**

3<sup>7</sup>/<sub>8</sub>" (99mm)

Catalog #	Description
355-092	Delicate, serrated, full curve, 0.5mm wide at tip

**Eye Dressing Forceps**

3<sup>7</sup>/<sub>8</sub>" (99mm)

Catalog #	Description
355-102	Serrated, full curve, 0.8mm wide at tip

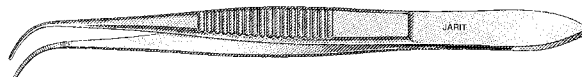

**Iris Forceps**

3 7/8" (99mm)

Catalog #	Description
355-095	Delicate, straight, 1 x 2 teeth, 0.6mm wide at tip

**Iris Forceps**

3 7/8" (99mm)

Catalog #	Description
355-110	Straight, 1 x 2 teeth, 0.8mm wide at tip



**Iris Forceps**

3 7/8" (99mm)

Catalog #	Description
355-096	Delicate, half curved, 1 x 2 teeth, 0.6mm wide at tip

**Iris Forceps**

3 7/8" (99mm)

Catalog #	Description
355-111	Half curved, 1 x 2 teeth, 0.8mm wide at tip



**Iris Forceps**

3 7/8" (99mm)

Catalog #	Description
355-097	Delicate, full curve, 1 x 2 teeth, 0.6mm wide at tip

**Iris Forceps**

3 7/8" (99mm)

Catalog #	Description
355-112	Full curve, 1 x 2 teeth, 0.8mm wide at tip

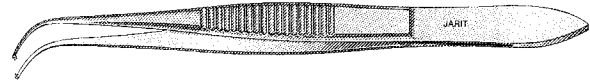

**Von Graefe Iris Forceps**

2 3/4" (72mm), straight, 0.7mm tip

Catalog #	Description
355-115	Serrated
355-116	1 x 2 teeth

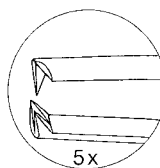
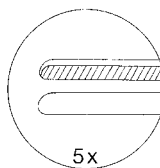

**Von Graefe Iris Forceps**

2¾" (72mm), curved, 0.7mm tip

Catalog #	Description
355-117	Serrated
355-118	1 x 2 teeth

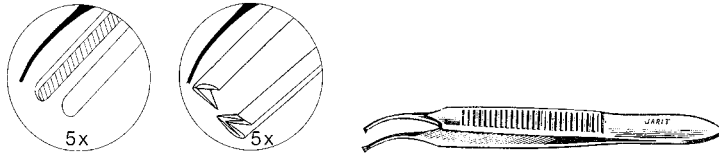

**Gill Iris Forceps**

3" (75mm)

Catalog #	Description
355-119	Curved, 0.5mm tip, 1 x 2 teeth

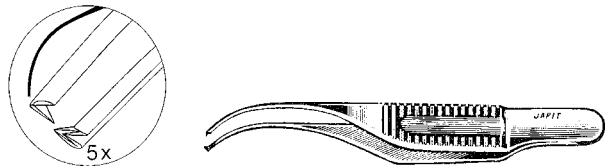

**Bishop-Harmon Iris Forceps**

Catalog #	Description
355-120	3½" (88mm), 0.6mm, 1 x 2 teeth
355-121	3¼" (82mm), 0.5mm, 1 x 2 teeth, extra delicate
355-122	3¼" (82mm), 0.4mm, 1 x 2 teeth, micro-surgery
355-123	3¾" (85mm), 0.6mm, serrated

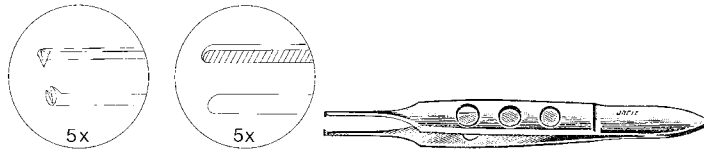

**Gill Iris Forceps**

3" (75mm)

Catalog #	Description
355-125	Curved, 0.7mm tip, 1 x 2 teeth down

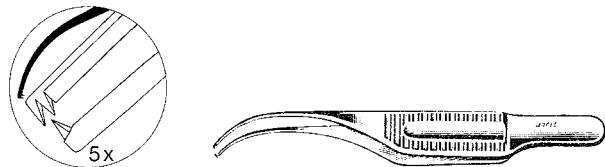

**Gill Iris Forceps**

3" (75mm)

Catalog #	Description
355-126	Curved, cross-serrated, .05mm tip

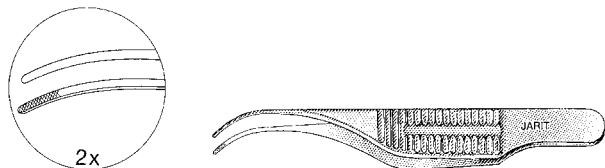

**Botvin Iris Forceps**

3" (75mm)

Catalog #	Description
355-128	Bayonet-shaped, cross-serrated, .05mm tip

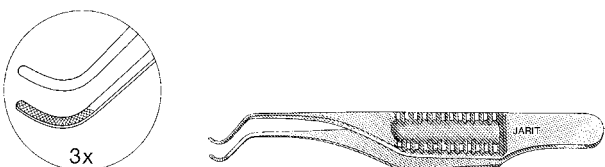

**Von Graefe Fixation Forceps**

4 3/8" (112mm)

Catalog #	Description
355-130	Plain, 4.5mm jaws

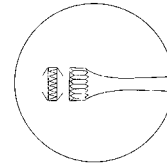

**Von Graefe Fixation Forceps**

4 3/8" (112mm)

Catalog #	Description
355-131	with Catch, 4.5mm jaws

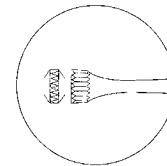

**Thorpe Conjunctival Fixation Forceps**

3 3/4" (95mm)

Catalog #	Description
355-132	2 x 3 teeth with (3mm) tying platform

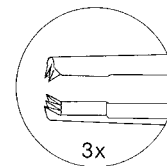

**Elsching Fixation Forceps**

4 1/8" (106mm)

Catalog #	Description
355-135	1 x 2 teeth (0.8mm tip)

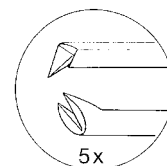

**Bracken Fixation Forceps**

4" (103mm)

Catalog #	Description
355-137	1 x 2 teeth (0.8mm tip)

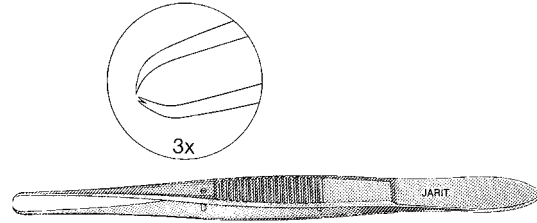

**Green Fixation Forceps**

4" (103mm)

Catalog #	Description
355-138	10mm jaws with fine teeth

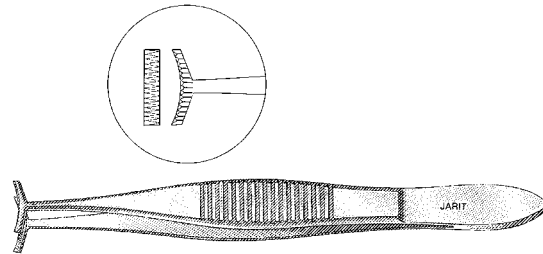

**Lester Fixation Forceps**

3 7/8" (97mm)

Catalog #	Description
355-140	1 x 2 teeth (0.55mm tip)

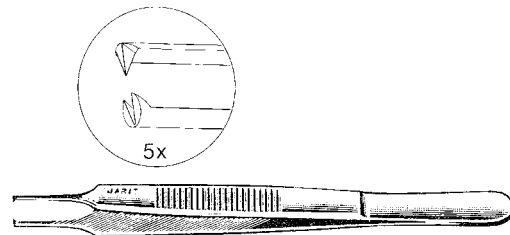

**Lester Fixation Forceps**

3 3/4" (96mm)

Catalog #	Description
355-141	2 x 3 teeth (1.1mm tip)

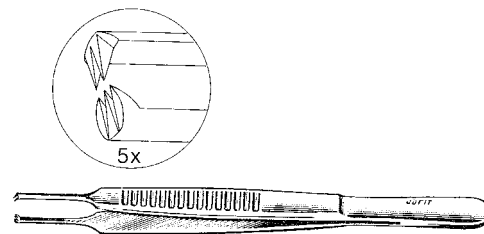

**Bonn Suture Forceps**

3¾" (96mm)

Catalog #	Description
355-142	0.12mm teeth, 4mm tying platform

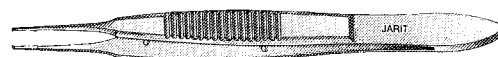
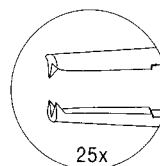

**Bonn Iris Forceps**

2¾" (70mm)

Catalog #	Description
355-143	Original pattern, 0.12mm teeth without tying platform

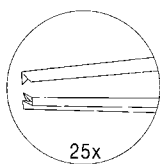

**Bonn Iris Forceps**

2¾" (70mm)

Catalog #	Description
355-144	0.12mm teeth, 4mm tying platform

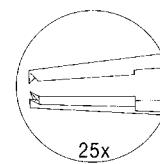

**Troutman-Barraquer Utility Forceps (Colibri-Type)**

2⅞" (73mm), teeth at 45° angle, 6.5mm tying platform

Catalog #	Description
355-145	0.12mm teeth
355-146	0.3mm teeth
355-147	0.5mm teeth

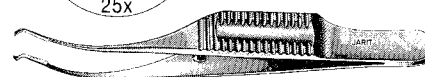
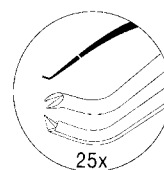

**Castroviejo Colibri Forceps**

4 1/8" (104mm)

Catalog #	Description
355-148	Wide handle, 0.12mm teeth, 7mm tying platform

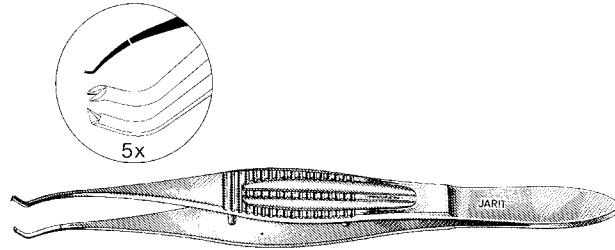

**Castroviejo Corneo-Scleral Suture Forceps**

3 7/8" (100mm), 6mm tying platform

Catalog #	Description
355-150	0.5mm teeth
355-151	0.9mm teeth
355-152	1.5mm teeth

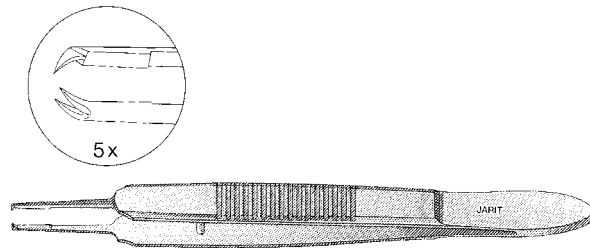

**Girard Corneo-Scleral Forceps (Colibri-Type)**

4 1/8" (104mm)

Catalog #	Description
355-155	For left hand, round knurled handle, 0.12mm teeth, 6mm tying platform

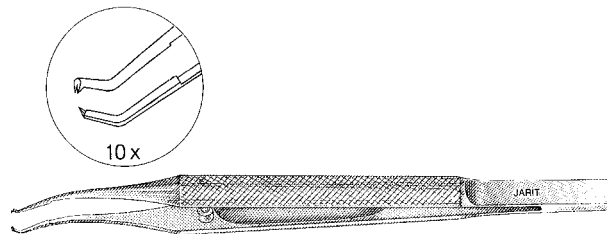

**Girard Corneo-Scleral Forceps (Colibri-Type)**

4 1/8" (104mm)

Catalog #	Description
355-156	For right hand, round knurled handle, 0.12mm teeth, 6mm tying platform

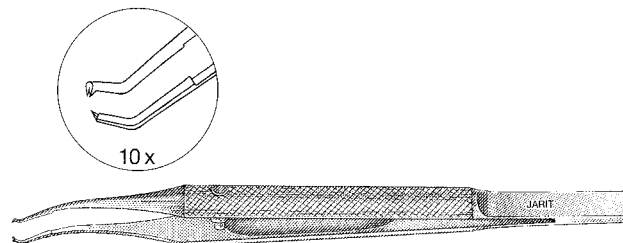

**Castroviejo Suture Tying Forceps**

4 1/4" (108mm), wide handle, 6mm tying platform

Catalog #	Description
355-159	0.12mm teeth
355-160	0.3mm teeth
355-161	0.5mm teeth
355-162	0.9mm teeth
355-163	1.5mm teeth

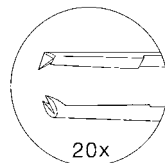

**Pierse Colibri Forceps**

3" (76mm)

Catalog #	Description
355-165	0.1mm Pierse type tip
355-166	0.2mm Pierse type tip

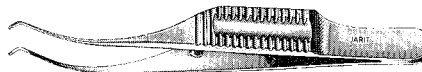
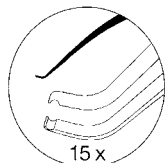

**Castroviejo Fixation Forceps**

4 1/4" (108mm), wide handle without tying platform

Catalog #	Description
355-168	0.3mm teeth
355-169	0.5mm teeth

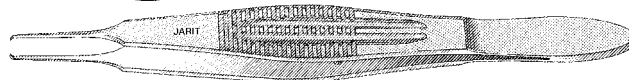
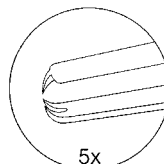



**Jewelers Style Forceps**

style #1: fine

Catalog #	Description
355-170	4 <sup>3</sup> / <sub>4</sub> " (120mm)

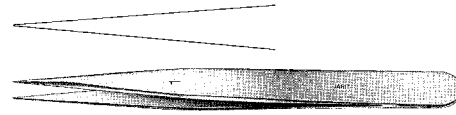

**Jewelers Style Forceps**

style #3: very fine

Catalog #	Description
355-171	4 <sup>3</sup> / <sub>4</sub> " (120mm)

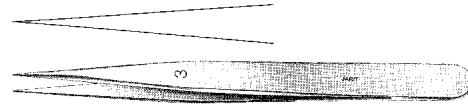

**Jewelers Style Forceps**

style #3C: very fine

Catalog #	Description
355-172	4 <sup>3</sup> / <sub>8</sub> " (110mm)

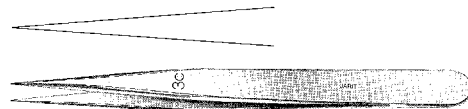

**Jewelers Style Forceps**

style #4: very fine

Catalog #	Description
355-173	Style 4: very fine, 4 <sup>3</sup> / <sub>8</sub> " (110mm)

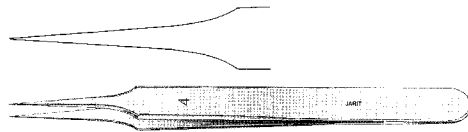

**Jewelers Style Forceps**

style #5: very fine

Catalog #	Description
355-174	Style 5: very fine, 4 <sup>3</sup> / <sub>8</sub> " (110mm)

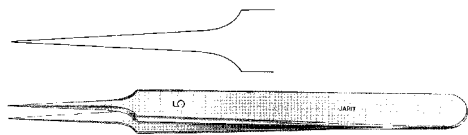

**Jewelers Style Forceps**

style #7: very fine

Catalog #	Description
355-175	4 <sup>1</sup> / <sub>2</sub> " (115mm)

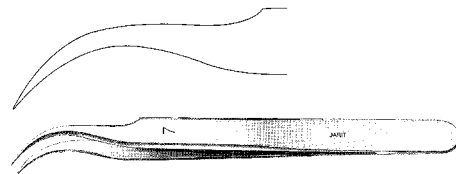

**Titanium**

**Jewelers Style Forceps, Titanium**

style #1: fine

Catalog #	Description
355-170TI	4 3/4" (120mm)

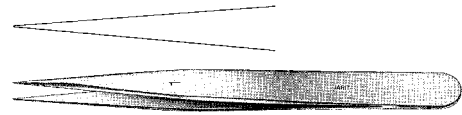

**Jewelers Style Forceps, Titanium**

style #3: very fine

Catalog #	Description
355-171TI	4 3/4" (120mm)

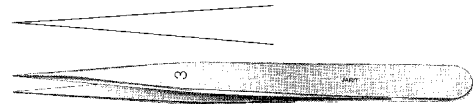

**Jewelers Style Forceps, Titanium**

style #7: very fine

Catalog #	Description
355-175TI	4 5/8" (118mm)

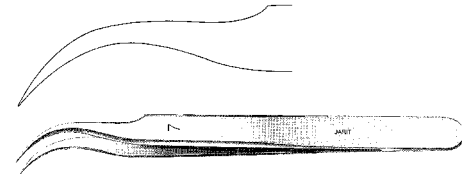

**Nugent Utility Forceps**

4 1/4" (108mm), 45° angled jaws (9.5mm)

Catalog #	Description
355-177	Smooth
355-178	Serrated

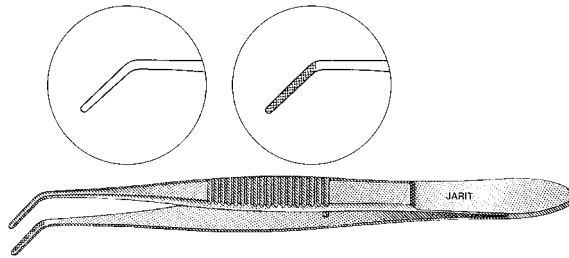

**Wills Hospital Utility Forceps**

4" (101mm)

Catalog #	Description
355-179	Cross-serrated (tips 14mm)

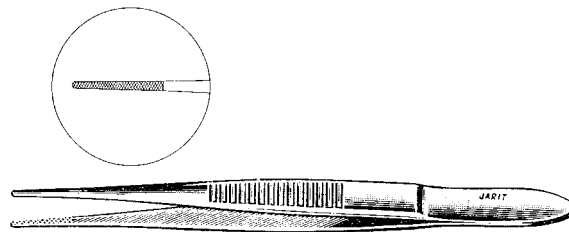

**McCullough Utility Forceps**

4" (101mm)

Catalog #	Description
355-180	Cross-serrated (tips 14mm)

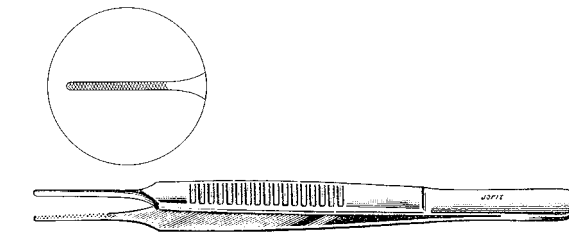

**McCullough Utility Forceps**

4" (101mm)

Catalog #	Description
355-181	1 x 2 teeth, cross-serrated (tips 14mm)

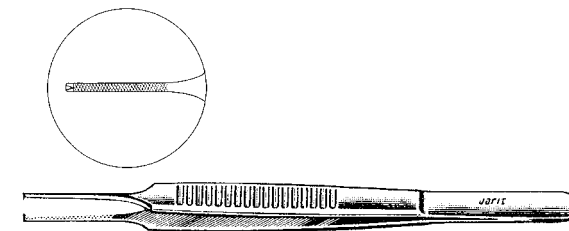

**Harms Suture Tying Forceps**

4 1/4" (108mm), wide handle, 6.5mm tying platform

Catalog #	Description
355-182	Straight
355-184	Curved

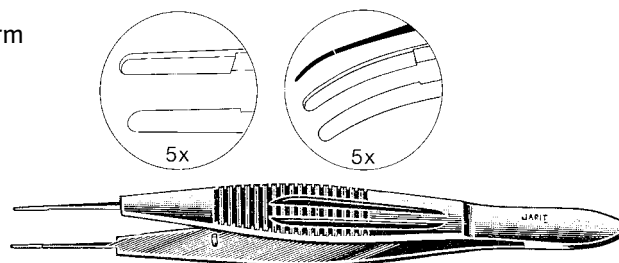

**Harms Suture Tying Forceps**

3 7/8" (100mm), regular handle, 6.2mm tying platform

Catalog #	Description
355-183	Straight
355-185	Curved

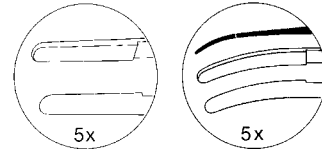

**Castroviejo Suture Tying Forceps**

4 1/8" (106mm)

Catalog #	Description
355-187	5mm tying platform

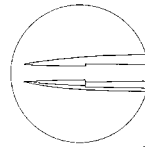

**Troutman-Barraquer Corneal Utility Forceps (Colibri-Type)**

3" (76mm)

Catalog #	Description
355-188	0.12mm teeth

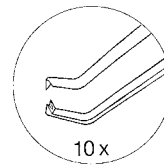

**Polack Double Corneal Forceps (Colibri-Type)**

2 7/8" (72mm)

Catalog #	Description
355-189	4mm long tips with 1 x 2 teeth

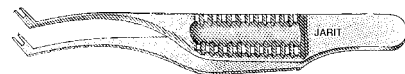
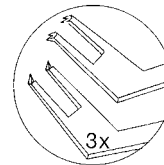

**Bonaccolto Utility Forceps**

4 3/8" (110mm), cross serrated

Catalog #	Description
355-191	1.25mm wide platform
355-192	1.75mm wide platform

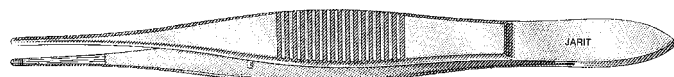
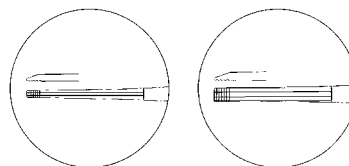

**Chandler Iris Forceps**

3" (75mm)

Catalog #	Description
355-193	0.5mm wide tips

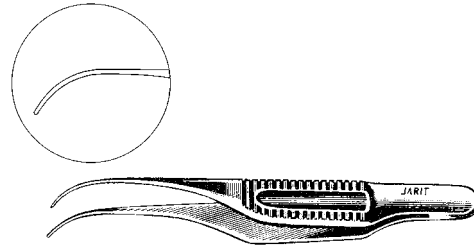

**Schaaf Foreign Body Forceps**

Catalog #	Description
355-200	3 3/4" (95mm)

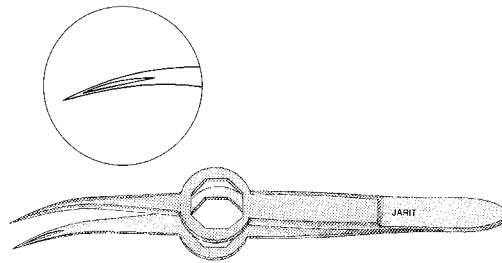

**Watzke Sleeve Spreading Forceps**

4 5/8" (117mm)

Catalog #	Description
355-202	cross-action, 0.65mm x 9.5mm serrated angled tip

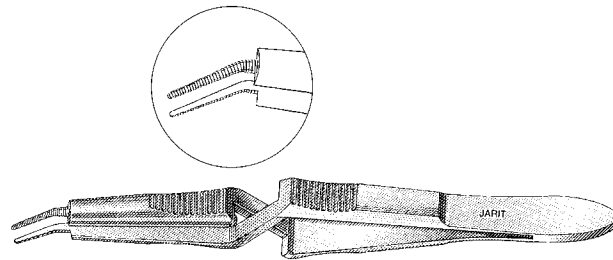

**Sauer Suture Forceps**

3 3/8" (87mm)

Catalog #	Description
355-203	0.6mm 1 x 2 teeth

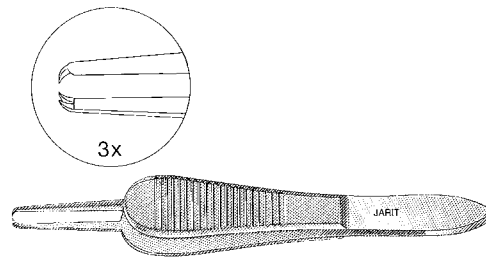

**McPherson Suture Tying Forceps**

3½" (89mm)

Catalog #	Description
355-205	Straight, 5.1mm tying platform

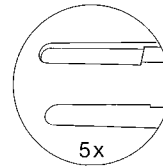

**McPherson Suture Tying Forceps**

3½" (89mm)

Catalog #	Description
355-206	Angled, 5.1mm tying platform

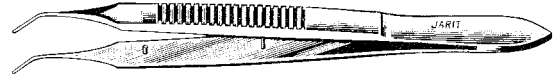
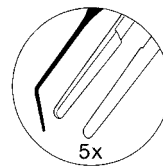

**McPherson Micro Corneal Forceps**

3½" (89mm)

Catalog #	Description
355-210	Straight, 1 x 2 teeth, 5.1mm tying platform

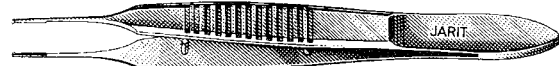
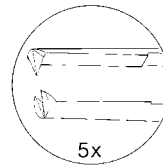

**McPherson Micro Corneal Forceps**

3½" (89mm)

Catalog #	Description
355-212	Angled, 0.4mm 1 x 2 teeth, 5.1mm tying platform

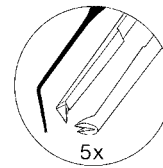

**Kelman-McPherson Suture Tying Forceps**

3<sup>3</sup>/<sub>8</sub>" (86mm)

Catalog #	Description
355-214	Angled, 0.4mm wide x 7.5mm tying platform

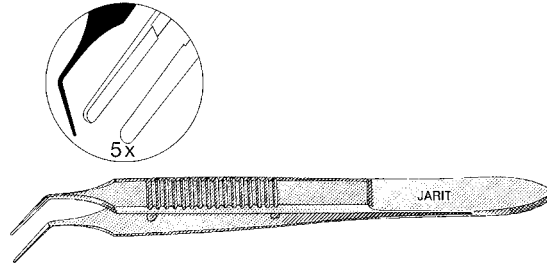

**Kelman-McPherson Micro Corneal Forceps**

3<sup>3</sup>/<sub>8</sub>" (86mm)

Catalog #	Description
355-215	Angled, 0.4mm x 2 teeth, 7.5mm tying platform

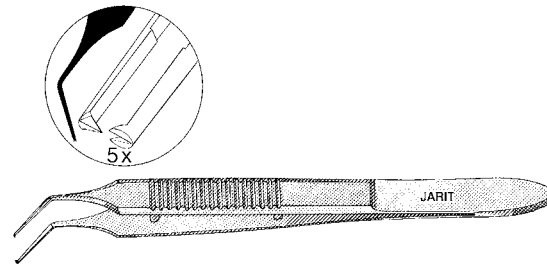

**Sheets-McPherson Tying Forceps**

3<sup>3</sup>/<sub>8</sub>" (86mm)

Catalog #	Description
355-218	45° angled jaws, 1.5mm cross-serrated tips, 10mm tying platform

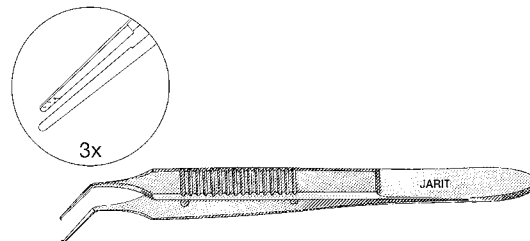

**Sinskey Tying Forceps**

4<sup>3</sup>/<sub>8</sub>" (110mm)

Catalog #	Description
355-220	Straight, 0.5mm x 7.5mm tying platform

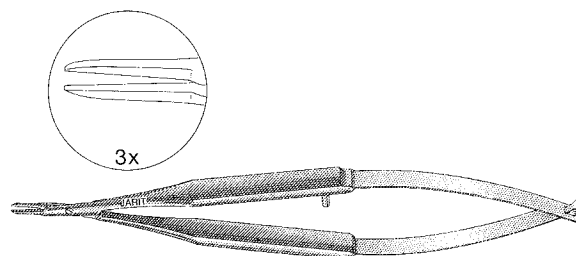

**Shepard Tying Forceps**

4 3/8" (111mm)

Catalog #	Description
355-225	Straight, wide handle, 0.4mm x 4.5mm tying platform

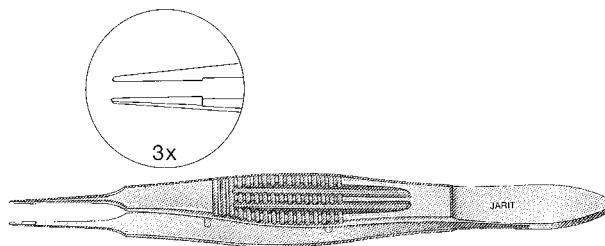

**Shepard Tying Forceps**

4 1/4" (108mm)

Catalog #	Description
355-226	45° angle, wide handle, 0.4mm wide x 5mm tying platform

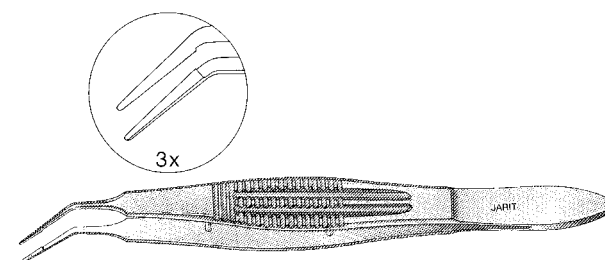

**Suture and Tying Forceps**

4 1/4" (108mm)

Catalog #	Description
355-230	Wide handle, 0.6mm wide x 7.3mm tying platform

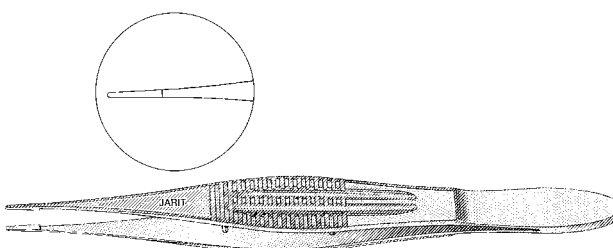

**Fine Tying Forceps**

4 1/4" (108mm)

Catalog #	Description
355-235	Wide handle, curved tips with tying surface

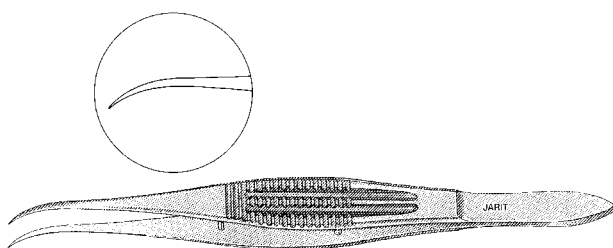



**Ziegler Cilia Forceps**

3 1/2" (90mm)

Catalog #	Description
355-250	4mm wide x 3mm tapered tips



**Littauer Cilia Forceps**

3 1/2" (90mm)

Catalog #	Description
355-255	3.5mm wide x 3.2mm tips



**Douglass Cilia Forceps**

3 1/2" (90mm)

Catalog #	Description
355-260	2.5mm wide tips



**Gradle Cilia Forceps**

3 7/8" (98mm)

Catalog #	Description
355-263	2.3mm wide platform

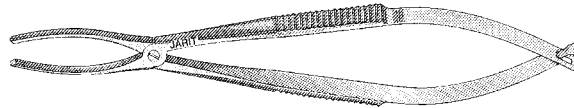

**Barraquer Cilia Forceps**

3 7/8" (98mm)

Catalog #	Description
355-265	8.5mm long platform



**Clayman Lens Forceps**

4 7/8" (123mm)

Catalog #	Description
355-280	Curved shafts, 2.4mm angled tips

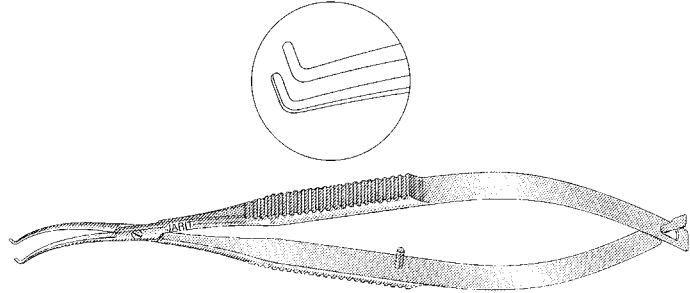

**Thornton Intraocular Lens Forceps**

3 3/8" (87mm)

Catalog #	Description
355-285	12mm angled jaws 45°

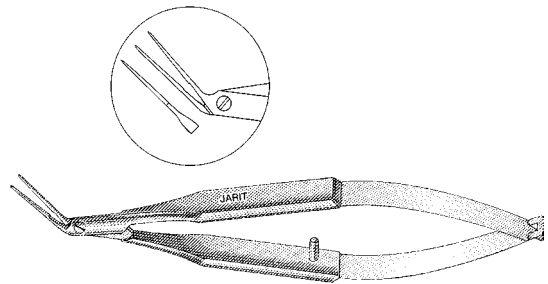

**Lambert Chalazion Forceps**

3<sup>5</sup>/<sub>8</sub>" (92mm)

Catalog #	Description
355-300	8mm inside diameter of fenestrated jaw

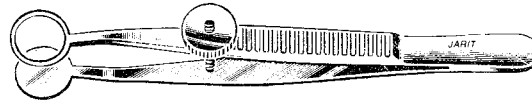

**Heath Chalazion Forceps**

3<sup>7</sup>/<sub>8</sub>" (99mm)

Catalog #	Description
355-303	11mm x 14mm inside diameter of fenestrated jaw

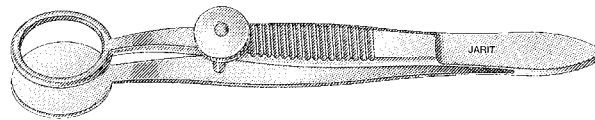

**Hunt Chalazion Forceps**

3<sup>7</sup>/<sub>8</sub>" (99mm)

Catalog #	Description
355-305	12mm inside diameter of fenestrated jaw

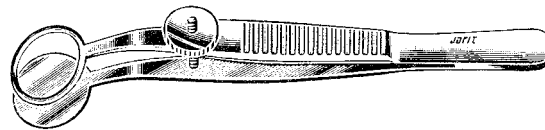

**Desmarres Chalazion Forceps**

3<sup>1</sup>/<sub>2</sub>" (89mm)

Catalog #	Description
355-310	12mm x 17mm inside diameter of fenestrated jaw
355-311	12.5mm x 23mm inside diameter of fenestrated jaw
355-312	17mm x 28mm inside diameter of fenestrated jaw

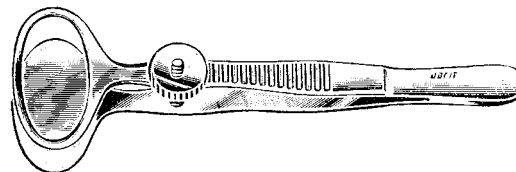

**Francis Chalazion Forceps**

3<sup>7</sup>/<sub>8</sub>" (99mm)

Catalog #	Description
355-315	12 x 14mm inside diameter of fenestrated jaw

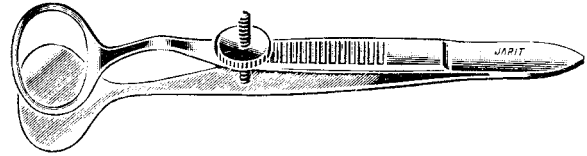

**Lordan Chalazion Forceps**

3<sup>3</sup>/<sub>4</sub>" (95mm)

Catalog #	Description
355-320	7.5 x 12mm inside dimensions of fenestrated jaw

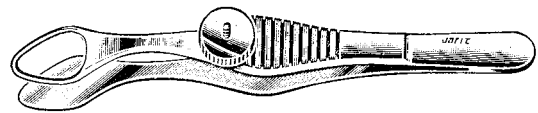

**Snellen Entropium Forceps**

3<sup>7</sup>/<sub>8</sub>" (97mm), 35mm wide solid plate

Catalog #	Description
355-340	Left
355-341	Right

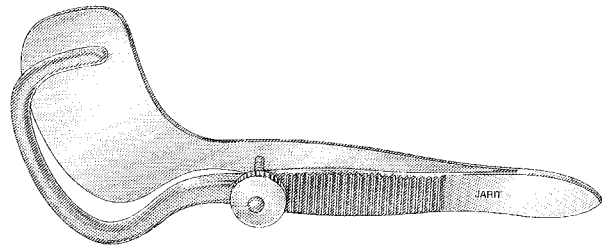

**Arruga Capsule Forceps**

4" (102mm)

Catalog #	Description
355-350	Capsule size 1.8mm x 3mm

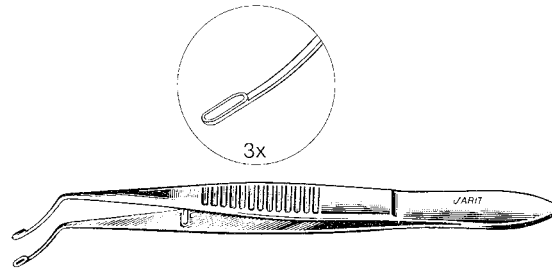

**Capsule Fragment and Clot Forceps**

2¼" (56mm)

Catalog #	Description
355-360	2mm platform and 1mm microscopic cups on inner jaw surface

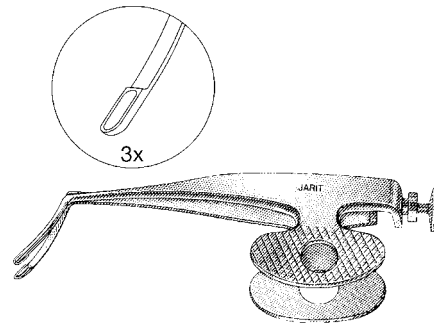

**Berke Ptosis Clamp**

3⅞" (100mm)

Catalog #	Description
355-370	20mm jaws

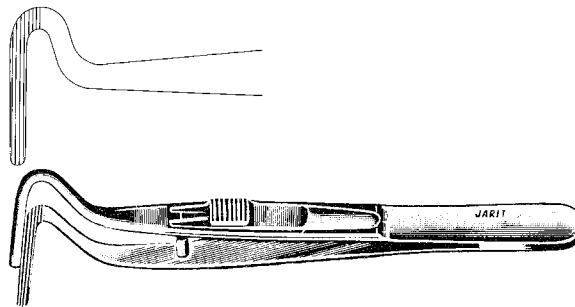

**Jameson Muscle Recession Forceps**

3⅞" (100mm)

Catalog #	Description
355-375	Left, 12mm jaws
355-376	Left, 7mm jaws
355-377	Right, 12mm jaws
355-378	Right, 7mm jaws

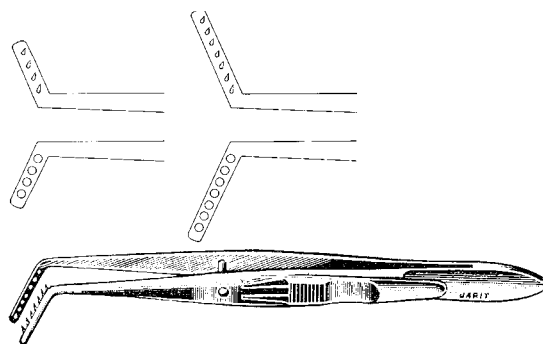

**Troutman Superior Rectus Forceps**

4⅛" (105mm)

Catalog #	Description
355-380	45° angle, 10mm from tip to bend

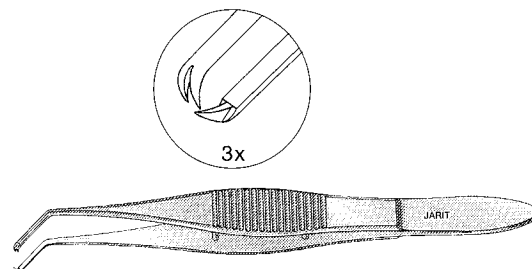

**Kalt Needle Holder**

5½" (140mm)

Catalog #	Description
355-400	12mm jaws, straight, serrated thumb plate with lock

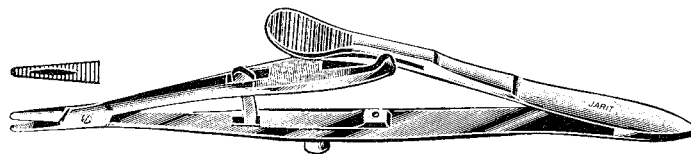

**Castroviejo Needle Holders, Flat Serrated Handles**

for use with 5.0 and 6.0 sutures  
5½" (140mm), 11.5mm smooth jaws,  
delicate tips 1.5mm

Catalog #	Description
355-404	Curved, locking
355-404NL	Curved, non-locking
355-405	Straight, locking
355-405NL	Straight, non-locking

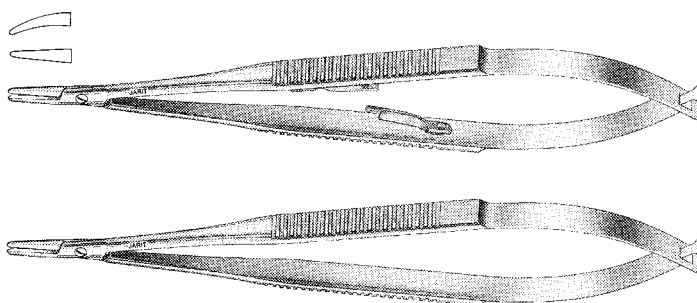

**Castroviejo Needle Holders, Flat Serrated Handles**

for use with 5.0 and 6.0 sutures  
5½" (140mm), 10.5mm smooth jaws,  
extra delicate tips 1.2mm

Catalog #	Description
355-406	Straight, locking
355-406NL	Straight, non-locking
355-407	Curved, locking
355-407NL	Curved, non-locking

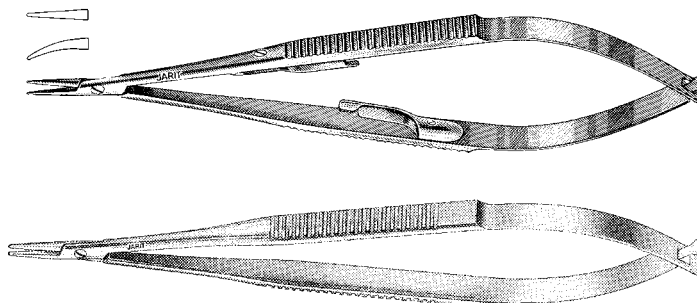

**Castroviejo Needle Holders, Wide Serrated Handles**

for use with 6.0, 7.0 and 8.0 sutures  
5" (127mm), 9mm smooth jaws,  
microsurgery tips 0.6mm

Catalog #	Description
355-408	Straight, non-locking
355-409	Curved, non-locking
355-410	Straight, locking
355-411	Curved, locking

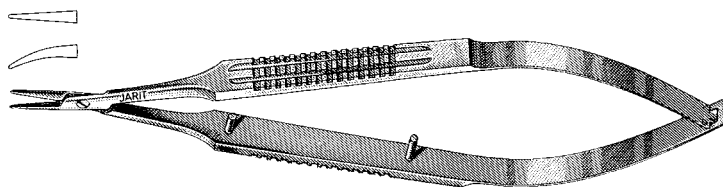

**Castroviejo Needle Holders, Carb-Bite**

flat serrated handles, for use with 6.0 and 7.0 sutures  
5½" (140mm), 11mm straight jaws,  
extra delicate tips 1.2mm

Catalog #	Description
355-412	Smooth, locking
355-412NL	Smooth, non-locking
355-413	Serrated, locking
355-413NL	Serrated, non-locking

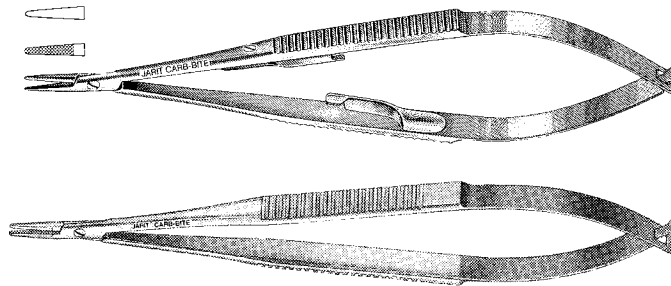

**Castroviejo Micro Stardust Needle Holders**

4¾" (120mm), round handle, 0.7mm micro tip

Catalog #	Description
278-220	Straight jaws, locking
278-221	Curved jaws, locking
278-222	Straight jaws, non-locking
278-223	Curved jaws, non-locking

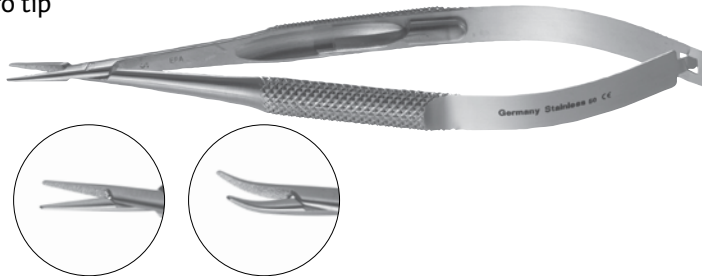

**Barraquer Needle Holders**

round knurled handles,  
5¼" (133mm), 9mm curved jaws,  
microsurgery tips .75mm

Catalog #	Description
355-415	Locking
355-416	Non-locking

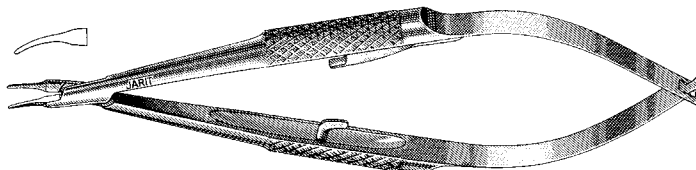

**Barraquer Needle Holders**

round knurled handles,  
4¾" (120mm), 10mm smooth jaws,  
microsurgery tips .7mm

Catalog #	Description
355-430	Straight, non-locking
355-432	Straight, locking
355-434	Curved, non-locking
355-436	Curved, locking

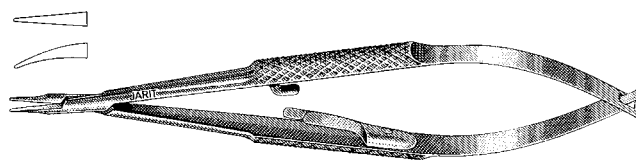

### McPherson Needle Holders

flat serrated handles,  
4" (102mm), 10mm smooth jaws,  
microsurgery tips .75mm

Catalog #	Description
355-450	Straight, non-locking
355-451	Straight, locking
355-452	Curved, non-locking
355-453	Curved, locking

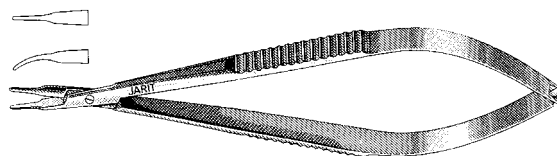

### Anis Needle Holders

round knurled handle without lock,  
5" (127mm), 8mm smooth jaws,  
microsurgery tips .6mm

Catalog #	Description
355-460	Straight
355-464	Curved

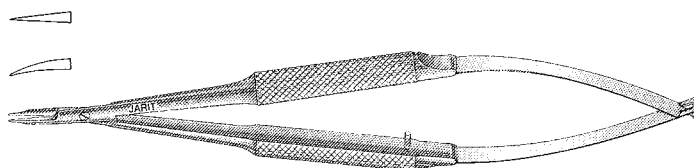

### Anis Needle Holders

round knurled handle with lock,  
5" (127mm), 8mm smooth jaws,  
microsurgery tips .6mm

Catalog #	Description
355-462	Straight
355-466	Curved

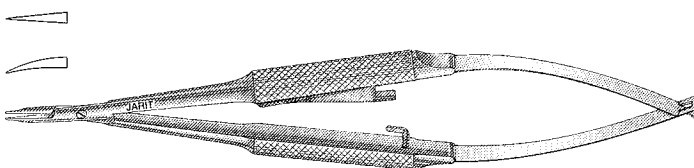

### Cohan Miniature Needle Holders

round knurled handles,  
4 1/8" (105mm), 7.5mm smooth curved jaws,  
microsurgery tips .6mm

Catalog #	Description
355-470	Non-locking
355-472	Locking

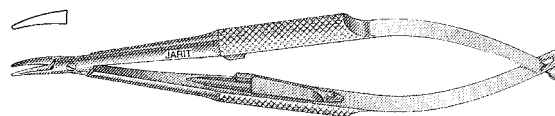

### Troutman Needle Holder

round serrated handle,  
4 5/8" (117mm), 10mm smooth curved jaws,  
delicate tips 1mm

Catalog #	Description
355-475	Non-locking

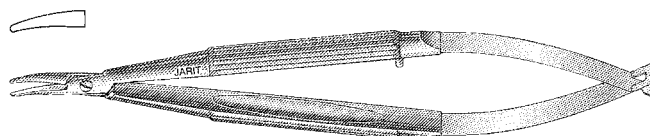



**Knapp Iris Scissors, Sharp-Sharp**

4" (103mm), 25mm blades

Catalog #	Description
360-090	Straight
360-093	Curved

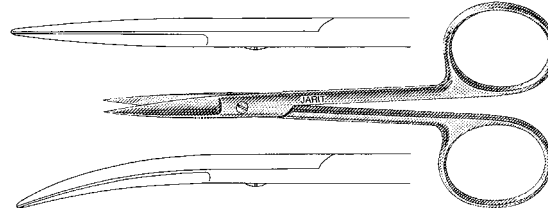

**Knapp Iris Scissors, Sharp-Blunt**

4" (103mm), 25mm blades

Catalog #	Description
360-091	Straight
360-094	Curved

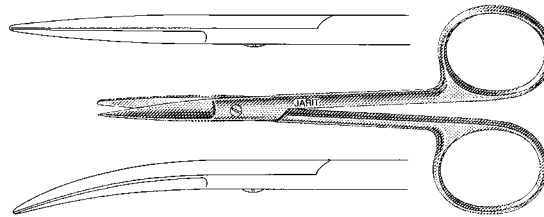

**Knapp Iris Scissors, Blunt-Blunt**

4" (103mm), 25mm blades

Catalog #	Description
360-092	Straight
360-095	Curved

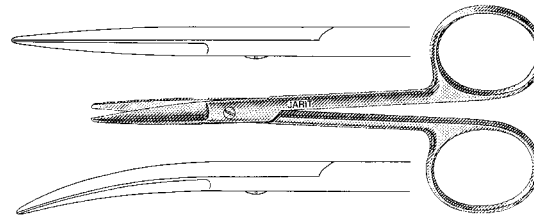

**Iris Scissors, Sharp-Sharp, (Mirror Finish)**

4<sup>5</sup>/<sub>8</sub>" (116mm), 25mm blades

Manufactured from high grade German surgical stainless steel which is ground and polished to a mirror finish

Catalog #	Description
360-100	Straight
360-101	Curved

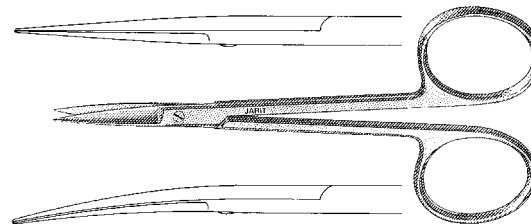

**Iris Scissors, Sharp-Sharp, (Matte Finish)**

4<sup>5</sup>/<sub>8</sub>" (116mm), 25mm blades

Manufactured from high grade German surgical stainless steel which is glass beaded to a matte finish

Catalog #	Description
359-100	Straight
359-101	Curved

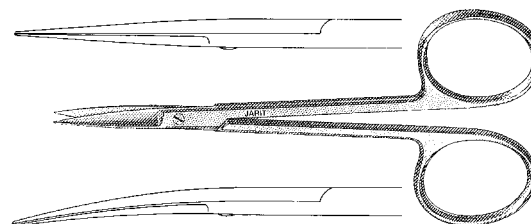

**Iris Scissors, Carb-Edge**  
4½" (114mm), 25mm blades

Catalog #	Description
101-300	Straight
101-301	Curved

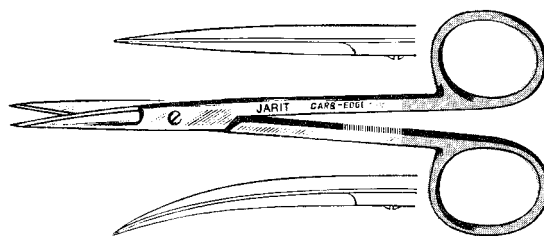

**Iris Scissors, Supercut**  
4⅝" (116mm), 25mm blades

Catalog #	Description
102-130	Straight
102-131	Curved

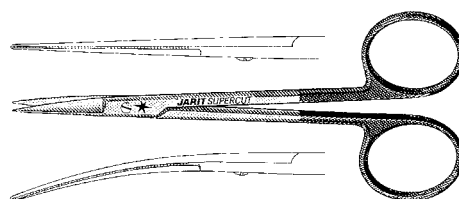

**Iris Scissors, Angled on the Side**  
(Mirror Finish)

Catalog #	Description
360-102	4½" (115mm), 27mm blades

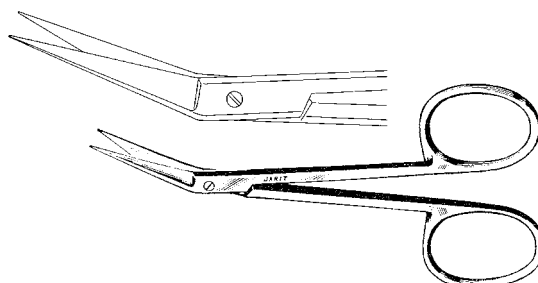

**Iris Scissors, Angled on the Side, Probe Point**  
(Mirror Finish)

Catalog #	Description
360-103	4½" (115mm), 27mm blades

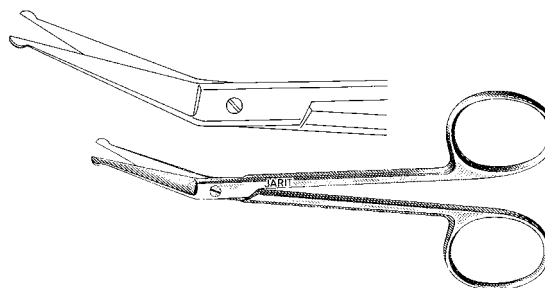

**Iris Scissors, Sharp-Sharp**  
(Mirror Finish)

Catalog #	Description
360-104	3¾" (94mm), straight, 22mm blades
360-105	3¾" (94mm), curved, 22mm blades
360-110	4⅛" (105mm), extra delicate, straight, 22mm blades
360-111	4⅛" (105mm), extra delicate, curved, 22mm blades

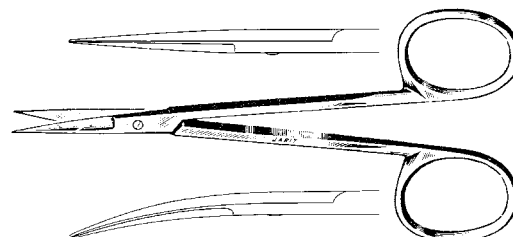

**Wilmer Conjunctival Scissors, Angled on the Flat**

Catalog #	Description
360-115	4 1/8" (105mm), delicate, 15mm blades

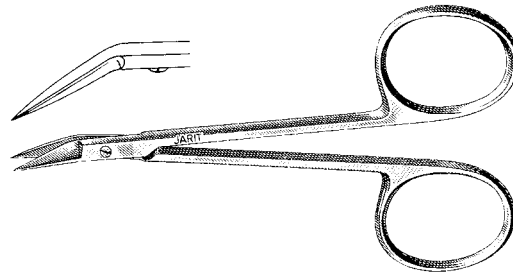

**Iris Scissors, Large Finger Rings**

3 7/8" (98mm), 22mm blades, (Satin Finish)

Catalog #	Description
360-117	Straight
360-118	Curved

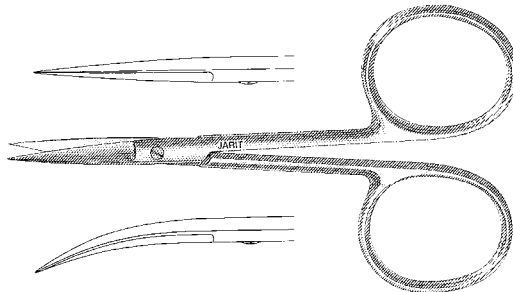

**Iris Scissors, Sharp-Sharp**

4" (103mm), delicate, 26mm blades, (Mirror Finish)

Catalog #	Description
360-120	Straight
360-121	Curved

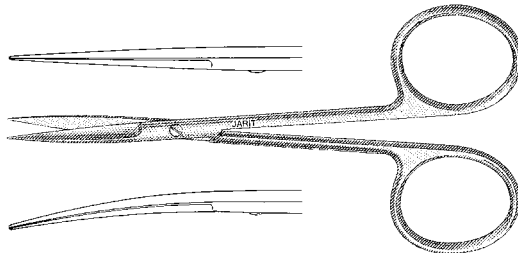

**Iris Scissors, Flat Shanks, Sharp-Sharp**

4 1/8" (104mm), 22mm blades, (Mirror Finish)

Catalog #	Description
360-122	Straight
360-123	Curved

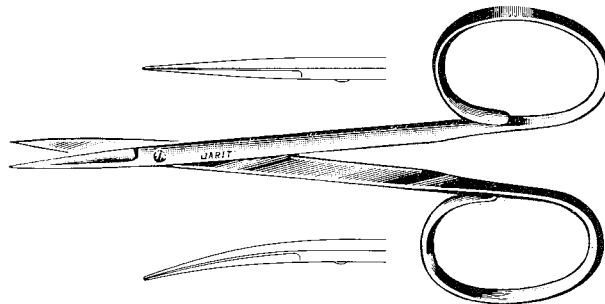

**Iris Scissors, Flat Shanks, Sharp-Sharp**

3 3/4" (96mm), delicate, 13.5mm blades, (Mirror Finish)

Catalog #	Description
360-125	Straight
360-126	Curved

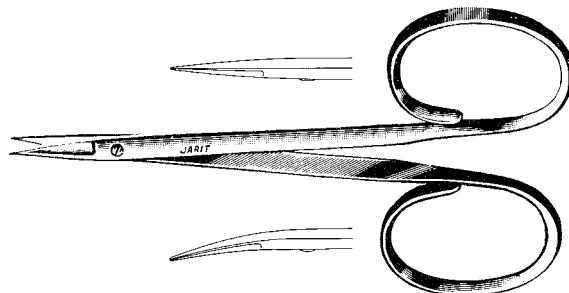

**Eye Utility Scissors, Flat Shanks, Blunt-Blunt**

3 7/8" (97mm), 16mm blades

Catalog #	Description
360-127	Straight
360-128	Curved

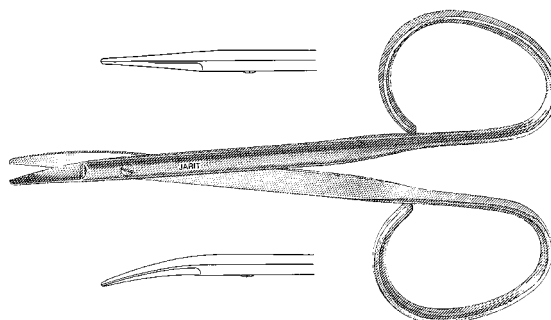

**Strabismus Scissors**

4 1/2" (115mm), 30mm blades

Catalog #	Description
360-130	Straight
360-131	Curved

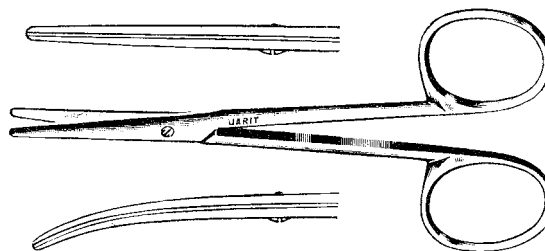

**Strabismus Scissors, Carb-Edge**

4 1/2" (114mm), 29mm blades

Catalog #	Description
101-310	Straight
101-311	Curved

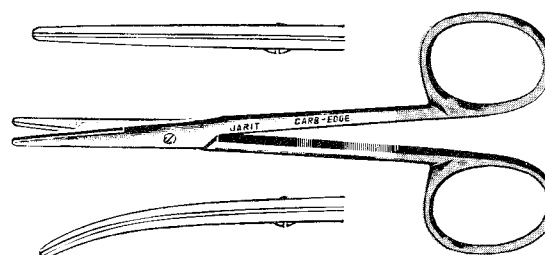

**Strabismus Scissors, Flat Shanks**

4 1/8" (106mm), 30mm blades

Catalog #	Description
360-134	Straight
360-135	Curved

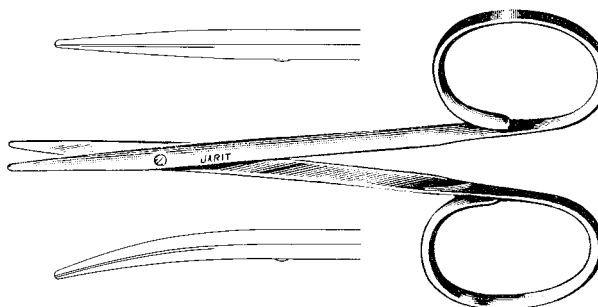

**Stevens Tenotomy Scissors, Blunt-Blunt**

Catalog #	Description
360-138	4½" (115mm), 13mm blades, straight, slender pattern
360-139	4½" (115mm), 13mm blades, curved, slender pattern
360-140	4½" (109mm), 12mm blades, straight, standard pattern
360-141	4½" (109mm), 12mm blades, curved, standard pattern

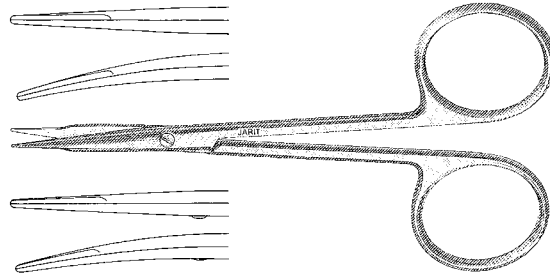

**Stevens Tenotomy Scissors, Blunt-Blunt**

3⅞" (98mm), flat shanks, 13mm blades

Catalog #	Description
360-142	Straight
360-143	Curved

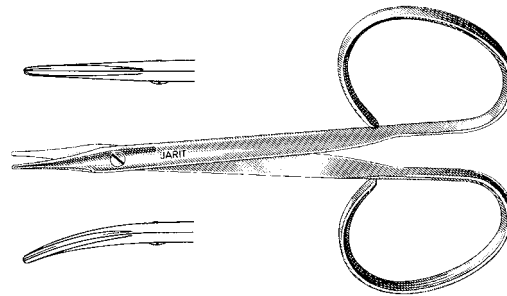

**Westcott Utility Scissors**

Catalog #	Description
360-144	5½" (130mm), 25mm blades, curved, round sharp tips

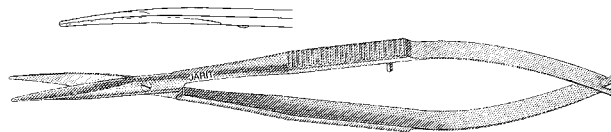

**Westcott Tenotomy Scissors**

4½" (115mm), 18mm blades, round blunt tips

Catalog #	Description
360-145	Right, curved
360-146	Left, curved
360-147	Straight

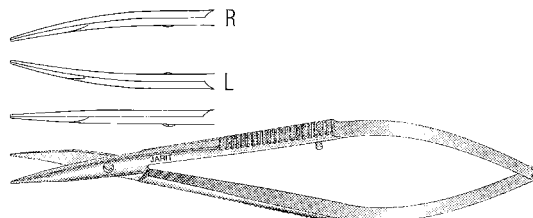

**Stevens Stitch Scissors**

Catalog #	Description
360-148	4 1/8" (105mm), 14mm blades, curved, sharp tips

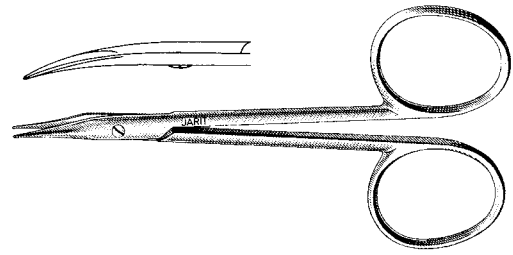

**Stevens Stitch Scissors**

Catalog #	Description
360-149	3 7/8" (98mm), 12mm blades, curved, sharp tips, flat shanks

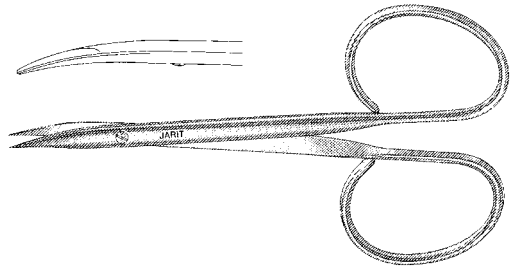

**Westcott Stitch Scissors**

Catalog #	Description
360-150	4 1/2" (115mm), 18mm blades, curved, fine sharp tips

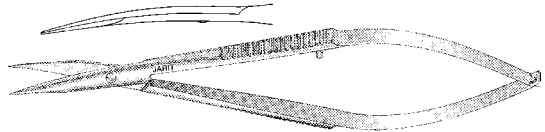

**Stevens Removal Scissors**

Catalog #	Description
360-151	4 3/8" (111mm), 12mm blades, curved, fine sharp tips, flat shanks

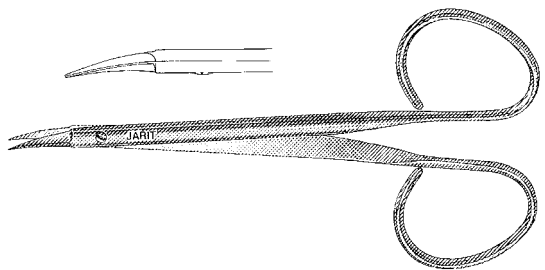

**Enucleation Scissors, Strong Curve**

Catalog #	Description
360-153	5 1/8" (130mm), 32mm blades

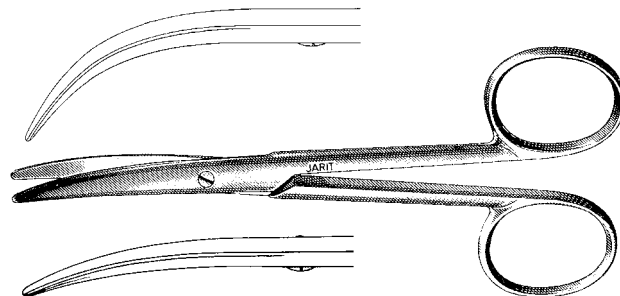

**Enucleation Scissors, Light Curve**

Catalog #	Description
360-157	5 1/8" (129mm), 27mm blades



**Stitch Scissors, Semi-Sharp Tips**

3 7/8" (100mm), 16.5mm blades

Catalog #	Description
360-154	Straight
360-155	Curved

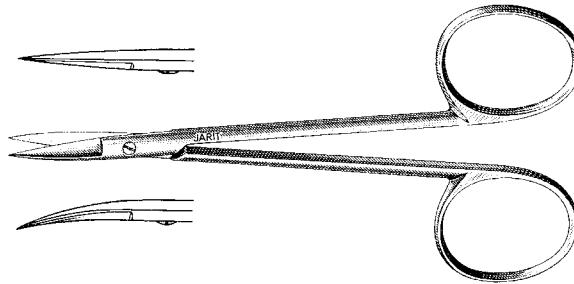

**Gradle Stitch Scissors, Blunt Tips**

Catalog #	Description
360-156	3 3/4" (95mm), 13mm blades

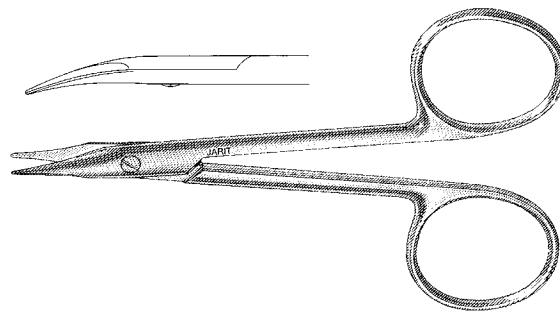

**O'Brien Suture Scissors**

Catalog #	Description
125-195	3 7/8" (100mm), 15mm blades, angled

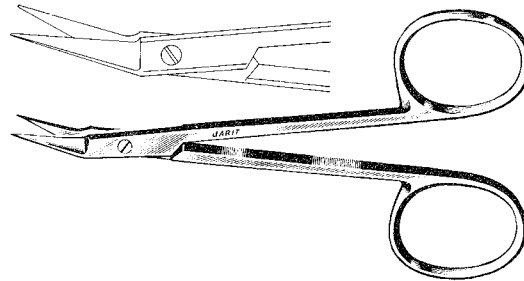

**Micro Stitch Scissors**

4" (102mm), 7mm blades, fine sharp tips

Catalog #	Description
360-158	Straight
360-159	Curved

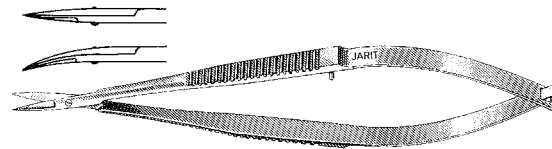

**Micro Stitch Scissors**

4 1/2" (114mm), 16mm blades, sharp tips

Catalog #	Description
360-160	Straight
360-161	Curved

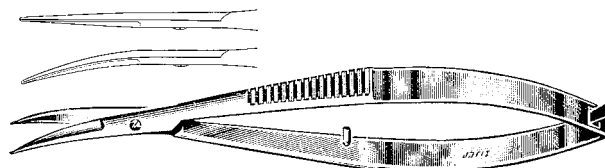

**McClure Iris Scissors**

4½" (114mm)

Catalog #	Description
360-165	15mm blades, angled on flat

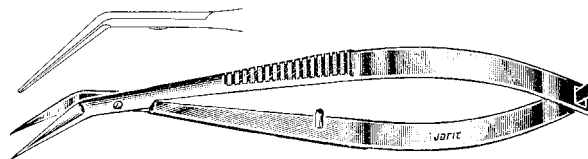

**Castroviejo Corneal Scissors**

4¾" (110mm)

Catalog #	Description
360-170	12mm blades, curved, blunt tips

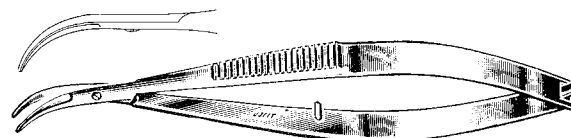

**Castroviejo Iris Scissors**

3¾" (95mm)

Catalog #	Description
360-172	11mm blades, curved, sharp tips

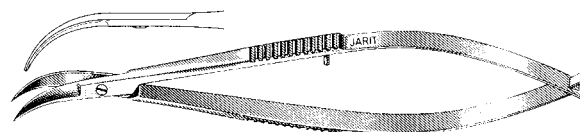

**Castroviejo Corneal Scissors**

4¼" (108mm)

Catalog #	Description
360-175	12mm blades, angled, blunt tips

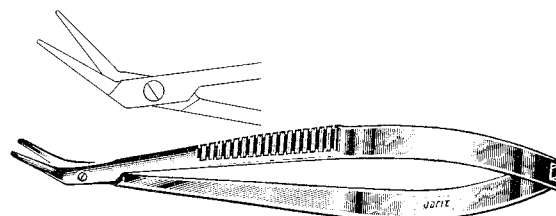

**Castroviejo Corneal Section Scissors**

4¼" (107mm), curved, blunt tips

Catalog #	Description
360-180	Right, standard, 13mm blades
360-181	Left, standard, 13mm blades
360-190	Right, miniature, 10mm blades
360-191	Left, miniature, 10mm blades

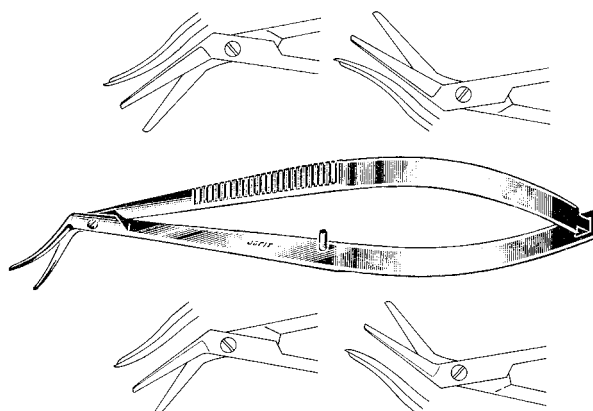



### Castroviejo Corneal Section Scissors

37/8" (100mm), microsurgery 7mm blades, curved, blunt tips

Catalog #	Description
360-192	Right
360-193	Left

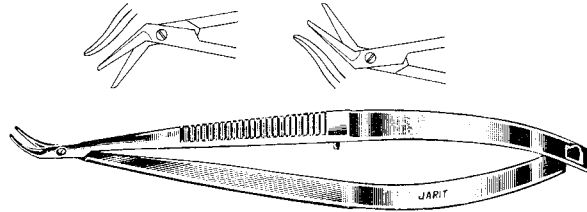

### Castroviejo Corneal Section Scissors

41/8" (105mm), miniature 7mm blades, curved, blunt tips

Catalog #	Description
360-195	Left
360-196	Right

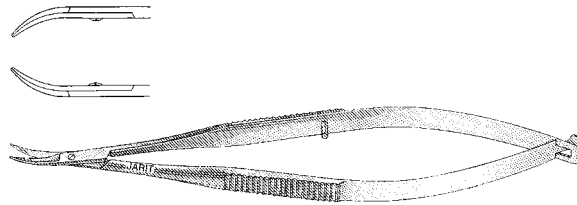

### Troutman-Castroviejo Corneal Section Scissors

41/4" (108mm), miniature 10mm blades, curved, blunt tips

Catalog #	Description
360-198	Left
360-199	Right

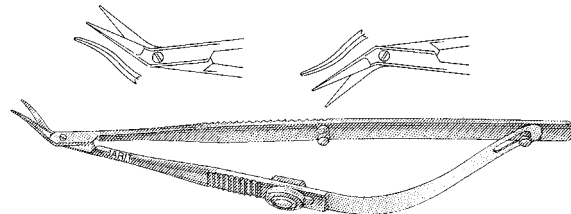

### Vannas Capsulotomy Scissors

31/4" (82mm), sharp tips

Catalog #	Description
360-200	Straight, 5.5mm blades
360-201	Curved, 5.5mm blades
360-202	Angled to side, 6.5mm blades
360-203	Angled on flat, 6.5mm blades

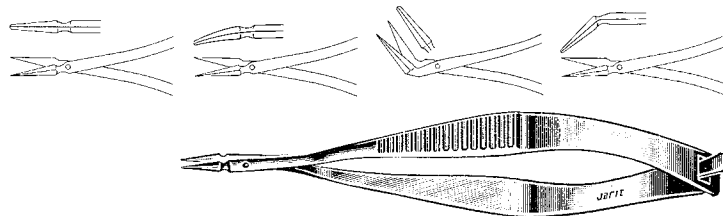

### Katzin Corneal Transplant Scissors

4 1/4" (108mm), miniature 10mm blades, curved, blunt tips

Catalog #	Description
360-205	Left
360-206	Right

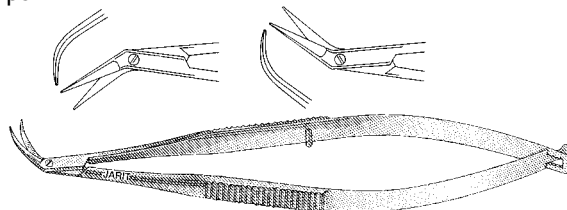

### McPherson-Vannas Iris Scissors

3 1/4" (81mm)

Catalog #	Description
360-215	5mm blades, curved, sharp tips

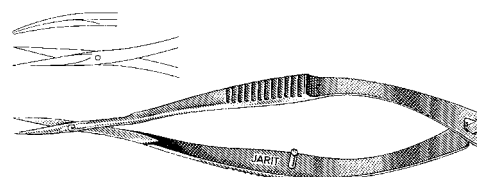

### Gills-Welsh Vannas Scissors

angled, sharp tips

Catalog #	Description
360-220	3 1/4" (84mm), microsurgery 6.5mm blades
360-225	3 3/8" (87mm), microsurgery 10mm blades

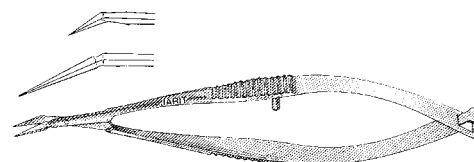

### Barraquer-Dewecker Iris Scissors

2 1/8" (55mm)

Catalog #	Description
360-234	8.2mm blades, angled on flat, 0.5mm wide blunt tips

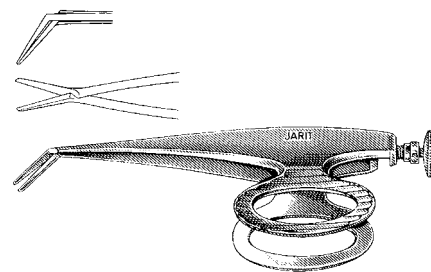

### Castroviejo Caliper

3 1/4" (82mm)

Catalog #	Description
360-250	Straight, measures from 0mm to 20mm in 1mm increments

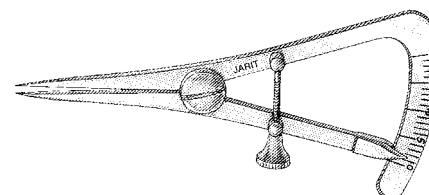

### Castroviejo Marking Caliper

3<sup>3</sup>/<sub>8</sub>" (86mm)

Catalog #	Description
360-251	Curved, measures from 0mm to 20mm in 1mm increments with grooves for marking fluid

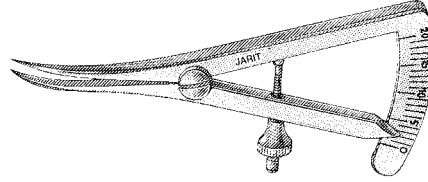

### Thorpe Caliper

4<sup>3</sup>/<sub>8</sub>" (110mm)

Catalog #	Description
360-253	Measures from 0mm to 80mm in 1mm increments and 0 to 3 inches in 1/16" increments

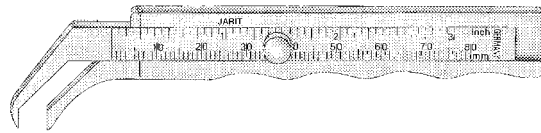

### Jameson Caliper

3<sup>3</sup>/<sub>8</sub>" (87mm)

Catalog #	Description
360-255	Measures from 0mm to 80mm in 1mm increments and 0 to 3 inches in 1/16" increments

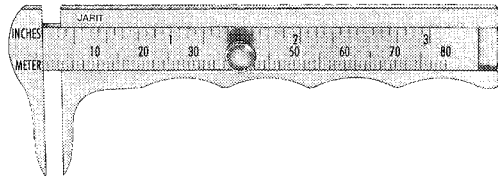

360-SSC-255 Replacement Set Screw Pkg/2ea

### Steel Ruler

Catalog #	Description
360-260	Graduated, 6" and 150mm



### Steel Ruler

Catalog #	Description
360-262	Graduated, 12" and 300mm

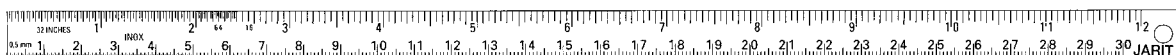

**Bowman Lacrimal Probes**

5 1/8" (130mm), double-ended stainless steel

Catalog #	Description
360-270	Set of 6
360-271	Sizes 0000-000
360-272	Sizes 00-0
360-273	Sizes 1-2
360-274	Sizes 3-4
360-275	Sizes 5-6
360-276	Sizes 7-8



**Bowman Lacrimal Probes**

5 1/8" (130mm), double-ended silver

Catalog #	Description
360-280	Sizes 0000-000
360-281	Sizes 00-0
360-282	Sizes 1-2
360-283	Sizes 3-4
360-284	Sizes 5-6
360-285	Sizes 7-8



**Williams Lacrimal Probes**

5 1/8" (130mm), double-ended silver

Catalog #	Description
360-286	Sizes 0000-000
360-287	Sizes 00-0
360-288	Sizes 1-2
360-289	Sizes 3-4
360-290	Sizes 5-6
360-291	Sizes 7-8



**Wilder Lacrimal Dilators**

3 7/8" (100mm)

Catalog #	Description
360-300	Short taper (14mm)
360-301	Medium taper (18mm)
360-302	Long taper (22mm)

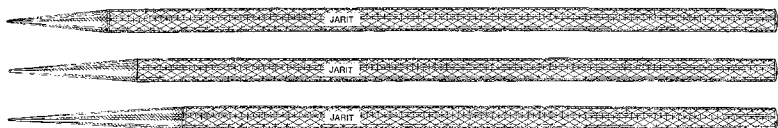

### Castroviejo Lacrimal Dilator

5½" (140mm)

Catalog #	Description
360-305	dDouble-ended (23mm tips)



### Ruedemann Lacrimal Dilator

2¾" (70mm)

Catalog #	Description
360-307	Short taper (22mm)



### Worst "Pigtail" Probe

5⅞" (149mm)

Catalog #	Description
360-310	10mm curved blunt tips with eye



### Harms Trabeculotome

1⅞" (48mm), 10mm long points with 3mm spread

Catalog #	Description
360-315	Right
360-316	Left

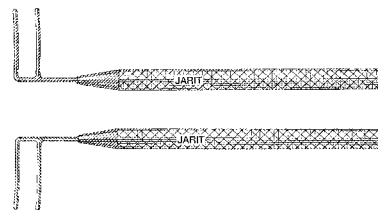

### Lachrymal Cannulas

reinforced, 23 gauge

Catalog #	Description
360-325	2⅛" (53mm), straight
360-326	1⅞" (49mm), curved



### Air Injection Cannulas

1 5/8" (40mm)

Catalog #	Description
360-330	30 gauge
360-331	27 gauge

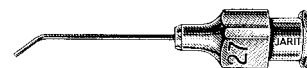

### Eye and Plastic Surgery Cases

for eye, plastic surgery, and microsurgical instruments, scissors, knives, and forceps, etc., are held securely on bed of silicone rubber, cover is removable

Catalog #	Description
360-502	10 1/2" x 10" (267mm x 254mm)
360-504	10 1/2" x 15" (267mm x 381mm)

### Eye and Plastic Surgery Cases

same as above; but stainless steel mesh is coated with autoclavable plastic for better protection of microsurgical instruments

Catalog #	Description
360-512	10 1/2" x 10" (267mm x 254mm)
360-514	10 1/2" x 15" (267mm x 381mm)



**Integra**<sup>™</sup>  
Ear & Nose  
Instruments and  
General Surgical  
Instruments

**Farrior Ear Specula**

oval, regular end

Catalog #	Description
375-020	3mm x 4mm
375-022	4mm x 5mm
375-024	4.5mm x 5.5mm
375-026	5mm x 6mm
375-028	5.5mm x 6.5mm
375-030	6mm x 7mm
375-032	6.5mm x 7.5mm
375-034	7mm x 8mm
375-036	7.5mm x 8.5mm

**Farrior Ear Specula**

oval, oblique end

Catalog #	Description
375-040	3mm x 4mm
375-042	4mm x 5mm
375-044	4.5mm x 5.5mm
375-046	5mm x 6mm
375-048	5.5mm x 6.5mm
375-050	6mm x 7mm
375-052	6.5mm x 7.5mm
375-054	7mm x 8mm
375-056	7.5mm x 8.5mm

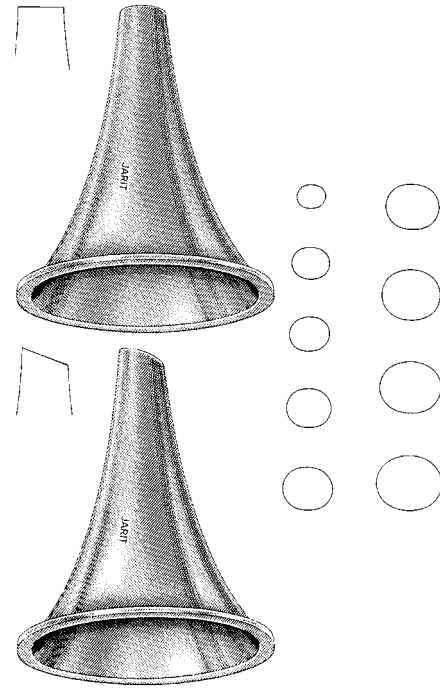

**Boucheron Ear Specula**

round

Catalog #	Description
375-100	Small set of 4
375-101	3mm
375-102	3.5mm
375-103	4.6mm
375-104	5.1mm

**Boucheron Ear Specula**

round

Catalog #	Description
375-110	Large set of 4
375-111	5.6mm
375-112	6.6mm
375-113	7.6mm
375-114	9.1mm

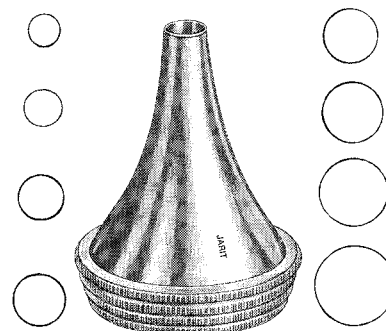



### Toynbee Ear Specula

round

Catalog #	Description
375-130	Set of 4
375-131	3mm
375-132	4mm
375-133	5mm
375-134	6.5mm

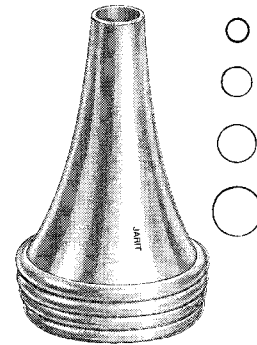

### Gruber Ear Specula

oval

Catalog #	Description
375-140	Set of 4
375-141	2.8mm x 3.8mm
375-142	3.8mm x 4.8mm
375-143	5mm x 6.2mm
375-144	6mm x 7.2mm

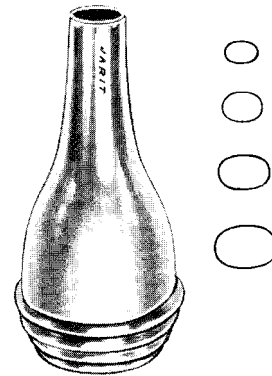

### Hartman Ear Specula

round

Catalog #	Description
375-150	Set of 4
375-151	4mm
375-152	5mm
375-153	6mm
375-154	7.5mm

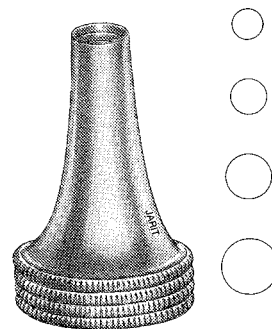

### Hartman Ear Specula

oval

Catalog #	Description
375-160	Set of 4
375-161	3.6mm x 4.2mm
375-162	4.6mm x 5.5mm
375-163	5.6mm x 6.7mm
375-164	6.9mm x 8.0mm

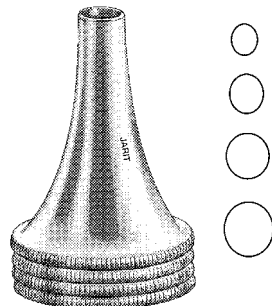

### Lucae Ear Dressing Forceps

Catalog #	Description
380-100	5½" (140mm), 1.8mm wide x 16mm length serrations

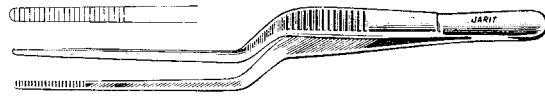

### Jansen Ear Dressing Forceps

Catalog #	Description
380-105	6¼" (161mm), 2mm wide x 17mm length serrations



### Wilde Ear Dressing Forceps

Catalog #	Description
380-110	4⅝" (117mm), 2mm wide x 14.5mm length serrations

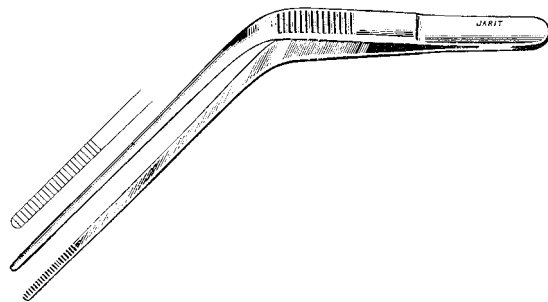

### Hartman Ear Dressing Forceps

2" (50mm) working length

Catalog #	Description
380-140	2mm x 6mm tapered jaws
380-141	2mm x 6mm jaws

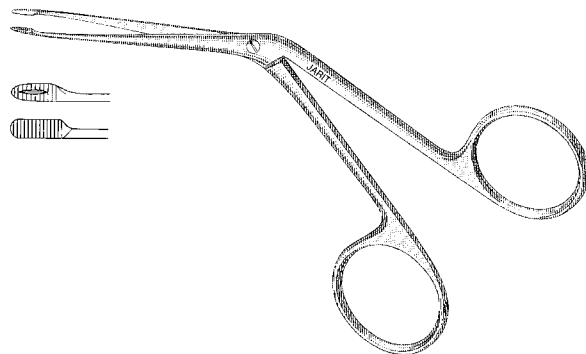

**Struempel Alligator Ear Forceps**

3 3/8" (87mm) working length, 5 3/4" (145mm) overall length

Catalog #	Description
380-143	oval cups, 2.5mm x 6mm

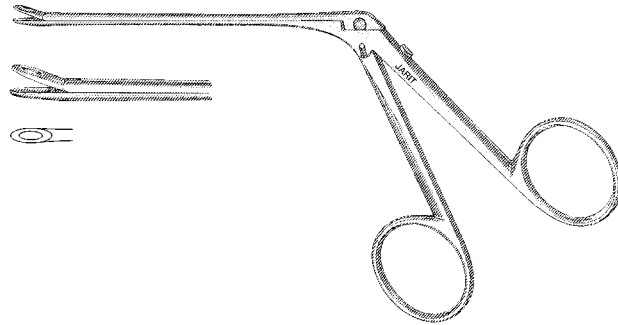

**Hartman-Herzfeld Alligator Ear Forceps**

3 3/8" (87mm) working length, 5 3/4" (145mm) overall length, round cups

Catalog #	Description
380-145	2mm
380-146	3mm
380-147	2mm, up-angled

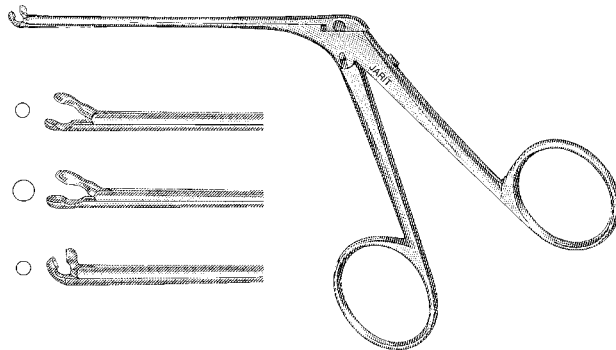

**Hartman Alligator Ear Forceps**

3 3/8" (87mm) working length, 5 3/4" (145mm) overall length

Catalog #	Description
380-149	1 x 2 teeth, serrated jaws, 1.6mm x 7mm
380-150	Serrated jaws, 1.8mm x 8mm

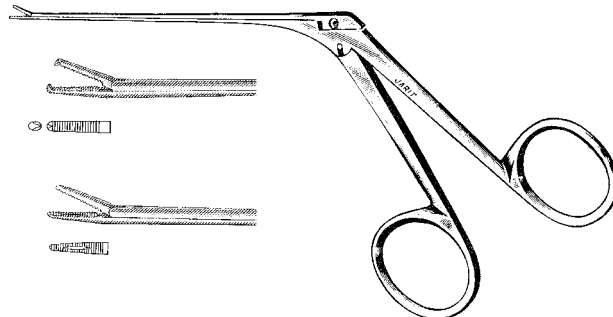

**Hartman Alligator Ear Forceps**

3 3/8" (87mm) working length, 5 3/4" (145mm) overall length

Catalog #	Description
380-153	Oval cups, 2mm x 7mm

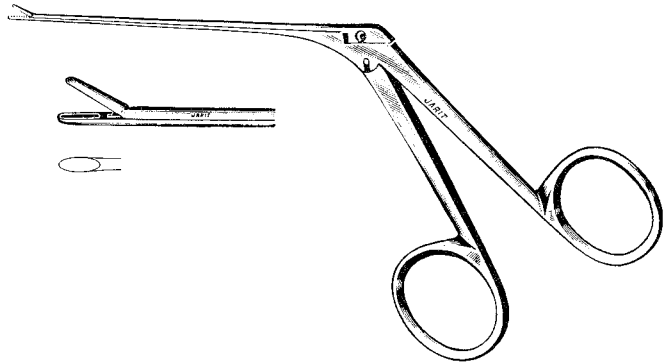

**Hartman Alligator Ear Forceps**

Catalog #	Description
380-155	5 1/2" (140mm) shaft, serrated jaws, 1.8mm x 8mm
380-156	6 1/4" (159mm) shaft, serrated jaws, 1.8mm x 8mm

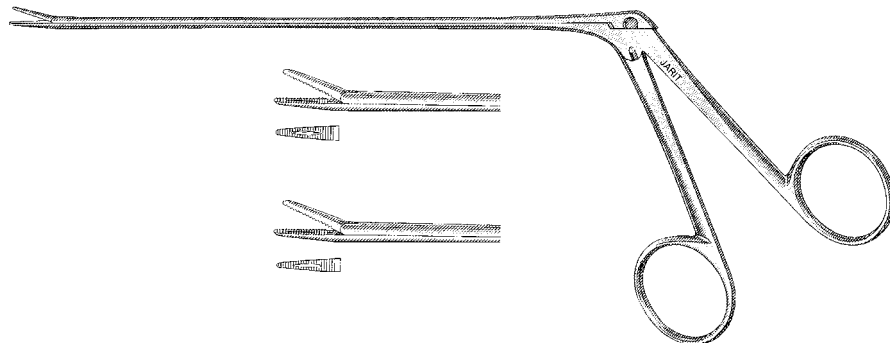

**Bellucci Micro Ear Scissor**

3 1/8" (78mm) shaft

Catalog #	Description
380-157	3.8mm length blade, ebony finish



**Hartmann Tuning Fork**

Catalog #	Description
380-165	128C, alloy metal



**Hartmann Tuning Fork**

Catalog #	Description
380-166	256C, alloy metal

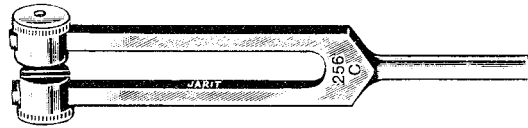

**Hartmann Tuning Fork**

Catalog #	Description
380-167	512C, alloy metal

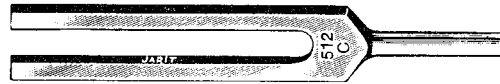

**Hartmann Tuning Fork**

Catalog #	Description
380-168	1024C, alloy metal

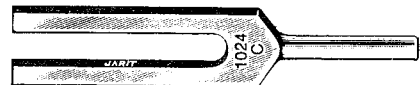

**Hartmann Tuning Fork**

Catalog #	Description
380-169	2048C, alloy metal



**Krause Ear Snare**

Catalog #	Description
380-175	7 1/8" (180mm), includes one package of 12 snare wires

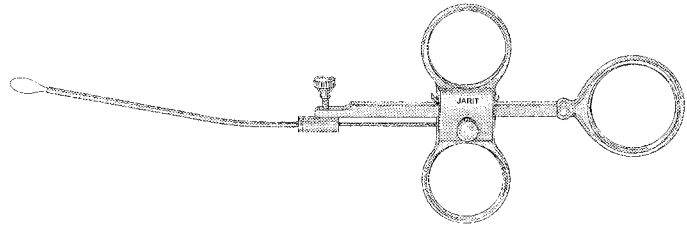

**Buck Ear Curettes**

5 3/4" (146mm), straight, blunt

Catalog #	Description
380-180	Size 00: 2.0mm OD
380-181	Size 0: 2.5mm OD
380-182	Size 1: 3.0mm OD
380-183	Size 2: 3.5mm OD
380-184	Size 3: 4.0mm OD



**Buck Ear Curettes**

5 3/4" (146mm), angled, blunt

Catalog #	Description
380-190	Size 00: 2.0mm OD
380-191	Size 0: 2.5mm OD
380-192	Size 1: 3.0mm OD
380-193	Size 2: 3.5mm OD
380-194	Size 3: 4.0mm OD



**Buck Ear Curettes**

5 3/4" (146mm), straight, sharp

Catalog #	Description
380-200	Size 00: 2.0mm OD
380-201	Size 0: 2.5mm OD
380-202	Size 1: 3.0mm OD
380-203	Size 2: 3.5mm OD
380-204	Size 3: 4.0mm OD



**Buck Ear Curettes**

5 3/4" (146mm), angled, sharp

Catalog #	Description
380-210	Size 00: 2.0mm OD
380-211	Size 0: 2.5mm OD
380-212	Size 1: 3.0mm OD
380-213	Size 2: 3.5mm OD
380-214	Size 3: 4.0mm OD



### Lempert Endaural Curettes

7<sup>3</sup>/<sub>4</sub>" (200mm)

Catalog #	Description
380-215	Size 5-0: 1.6mm x 2.5mm cup
380-216	Size 4-0: 2mm x 2.9mm cup
380-217	Size 3-0: 2.3mm x 3.6mm cup
380-218	Size 2-0: 2.8mm x 4mm cup
380-219	Size 0: 3.4mm x 5.7mm cup
380-220	Size 1: 3.8mm x 6.5mm cup
380-221	Size 2: 4.3mm x 7mm cup

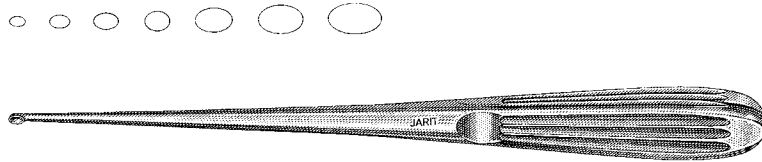

### Shapleigh Ear Curettes

6" (155mm), serrated

Catalog #	Description
380-223	Small: 2mm loop
380-224	Large: 3mm loop

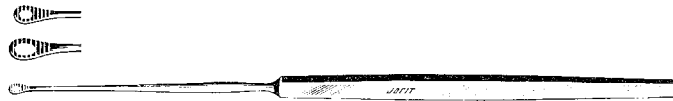

### Billeau Ear Loops

6<sup>1</sup>/<sub>2</sub>" (165mm)

Catalog #	Description
380-225	Large: 5mm x 9.2mm loop
380-226	Medium: 3.6mm x 5.6mm loop
380-227	Small: 2.5mm x 4mm loop

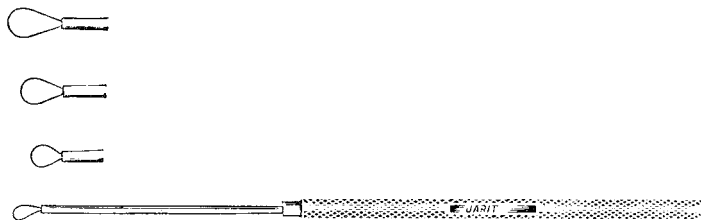

**Day Ear Hooks**

6¾" (171mm)

Catalog #	Description
380-230	Small: 2mm blunt tip
380-231	Large: 2.5mm blunt tip



**Allport Incus Hook**

Catalog #	Description
380-232	6¾" (171mm), 90° angle, 3mm blunt tip

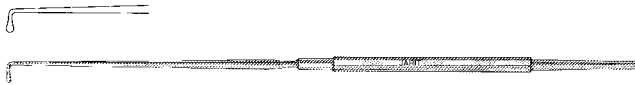

**Gross Ear Hook and Spoon**

Catalog #	Description
380-233	5⅞" (130mm), 90° angle, 4mm blunt tip, 3.6mm x 9mm spoon





### Sexton (Gerzog) Ear Knives

Catalog #	Description
380-235	6½" (163mm), straight shaft, 2.5mm blade
380-236	7¼" (185mm), bayonet shaft, 2.3mm blade
380-237	6" (153mm), angular shaft, 2mm blade

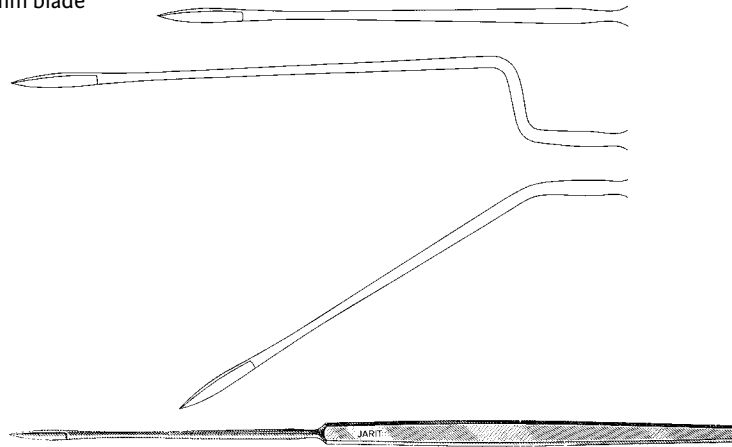

### Myringotomy Knives

6½" (165mm)

Catalog #	Description
380-238	Straight, 9mm blade
380-239	Slightly curved, 11mm blade

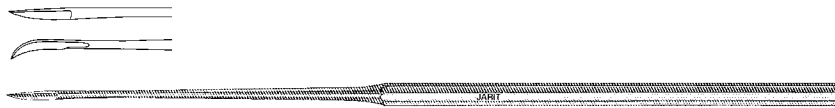

### Politzer Ear Knife

Catalog #	Description
380-242	6½" (164mm), angular shaft, 2.6mm x 5.5mm blade

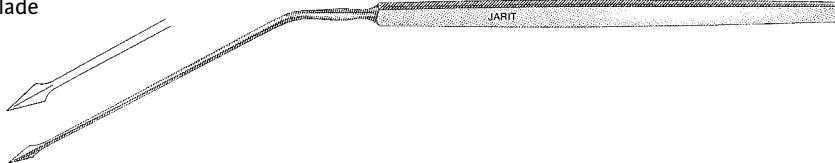

**Buck Myringotomy Knife**

Catalog #	Description
380-244	6 <sup>7</sup> / <sub>8</sub> " (175mm), 2.7mm x 5.4mm blade



**Andrew Mastoid Chisels**

5<sup>7</sup>/<sub>8</sub>" (150mm)

Catalog #	Description
380-270	5mm
380-271	7mm
380-272	9mm
380-273	11mm



**Andrew Mastoid Gouges**

5<sup>7</sup>/<sub>8</sub>" (150mm)

Catalog #	Description
380-275	6mm
380-276	8mm
380-277	10mm



**Kerrison Mastoid Rongeurs**

3 1/2" (90mm) working length

Catalog #	Description
380-300	Size 0: 3mm bite
380-301	Size 1: 4mm bite
380-302	Size 2: 5mm bite
380-303	Size 3: 6mm bite

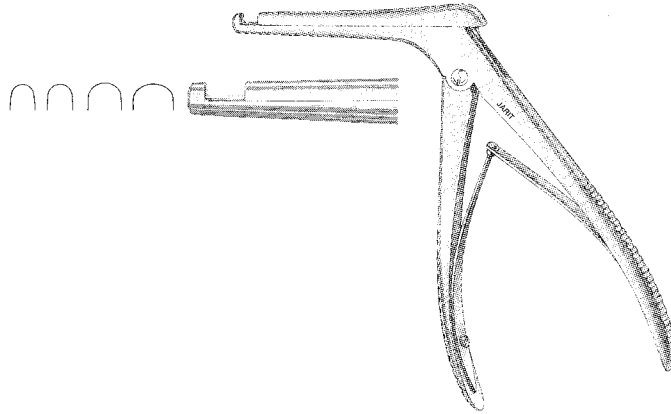

**Kerrison-Costen Rongeur**

4" (100mm) working length

Catalog #	Description
380-305	4mm bite

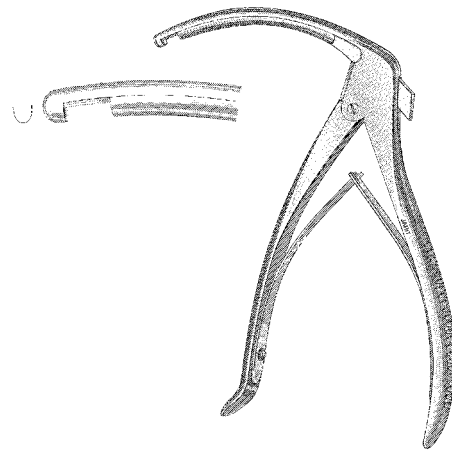

**Citelli Rongeur**

3 3/8" (86mm) working length

Catalog #	Description
380-307	Size 1: 2mm bite

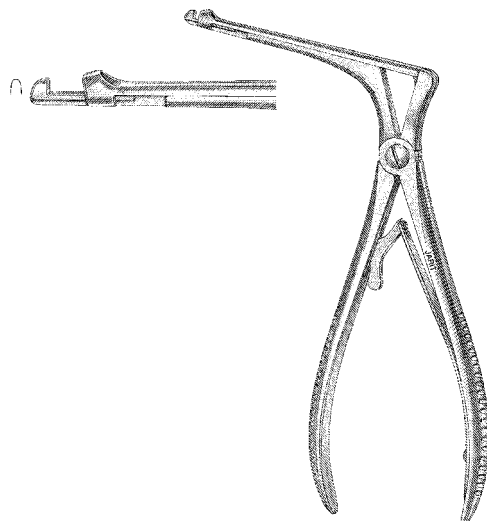

**Blumenthal Rongeur**

Catalog #	Description
230-097	6" (155mm), 30 deg, 3mm jaw width

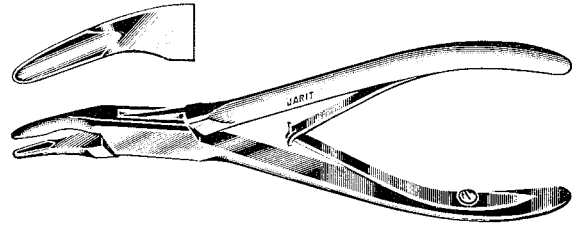

**Micro Friedman Rongeur**

1.3mm bite

Catalog #	Description
230-093	5½" (140mm), straight

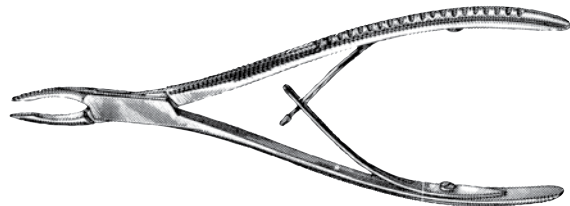

**Micro Friedman Rongeurs**

2.4mm bite

Catalog #	Description
230-098	4½" (132mm)
230-099	5⅝" (142mm)

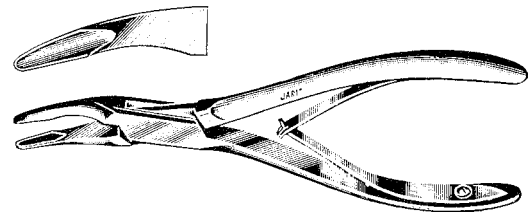

**Luer Rongeurs**

7¼" (182mm), 8mm bite

Catalog #	Description
230-100	Straight
230-102	Curved

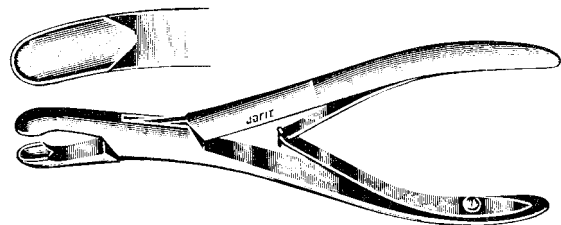

**Shearer Chicken Bill Rongeurs**

Catalog #	Description
230-105	5⅝" (142mm), 5mm bite
230-106	6¾" (170mm), 4.4mm bite

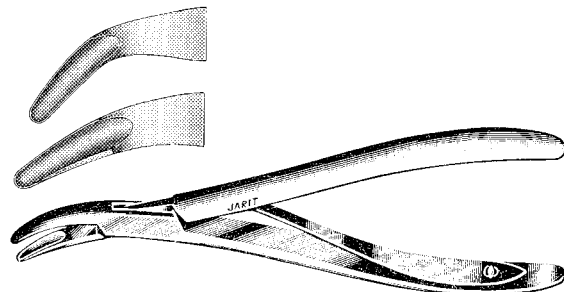

**Reiner Rongeurs**

7" (178mm)

Catalog #	Description
230-110	3.2mm bite, light curve
230-111	4.2mm bite, light curve
230-112	5.8mm bite, light curve

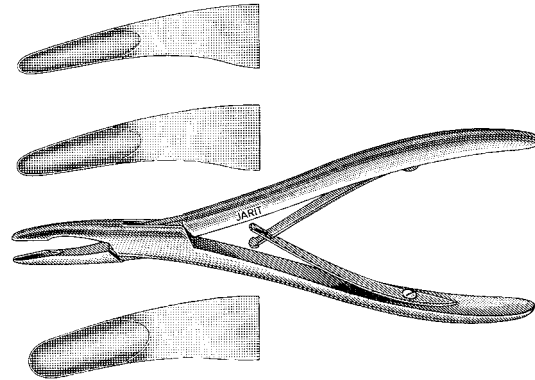

**Hartman Rongeurs**

5 7/8" (150mm)

Catalog #	Description
230-120	4.5mm bite, Straight, jaw width from 4.5mm to 5.7mm
230-121	4.5mm bite, Half curved, jaw width from 4.5mm to 5.4mm
230-122	4.5mm bite, Full curved, jaw width from 4.5mm to 5.5mm

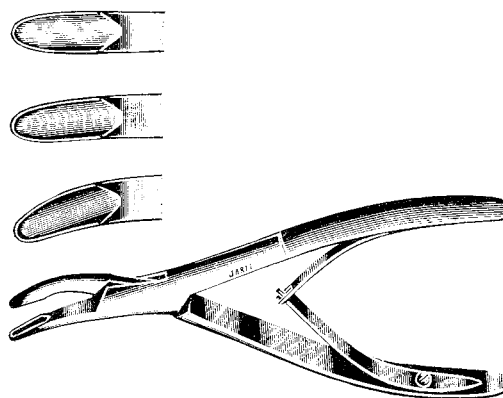

**Bane Rongeurs**

7" (175mm)

Catalog #	Description
230-124	4mm bite, curved
230-125	5mm bite, curved

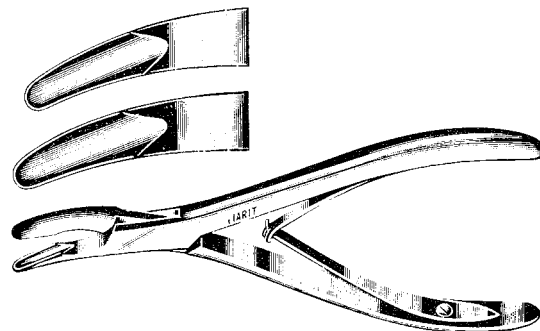

**Lempert Rongeurs**

2.5mm bite

Catalog #	Description
230-130	6¼" (158mm), straight
230-131	6¼" (158mm), curved
230-135	7½" (188mm), straight
230-136	7½" (188mm), curved

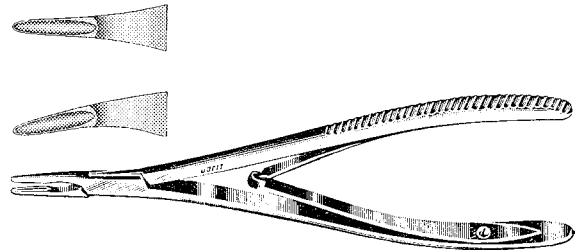

**Juers-Lempert Rongeur**

Catalog #	Description
230-138	7¼" (185mm), curved handle, 3mm bite

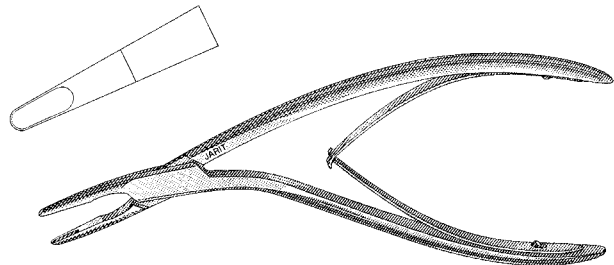

**Dean Rongeur**

Catalog #	Description
230-142	5¾" (146mm), 5mm bite, strong curve

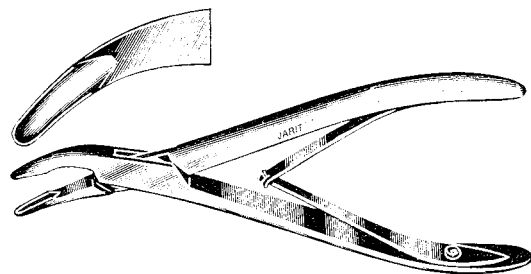

**Cicherelli Rongeur**

Catalog #	Description
230-145	6½" (165mm), 3.5mm bite, strong curve

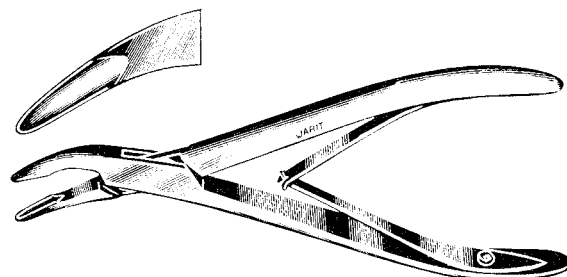

### Beyer Rongeur

Catalog #	Description
230-205	7" (178mm), 3mm bite, light curve
230-SPS-205	Replacement Spring and Screw

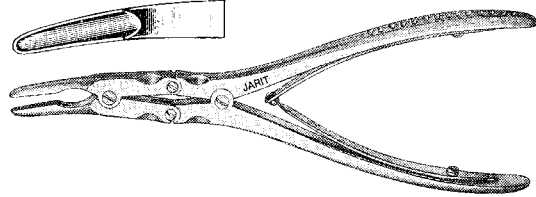

### Ruskin Rongeurs

7 1/4" (185mm)

Catalog #	Description
230-210	Straight, 5mm bite
230-211	Curved, 5mm bite
230-214	Straight, 6mm bite
230-215	Curved, 6mm bite
230-SPS-205	Replacement Spring and Screw

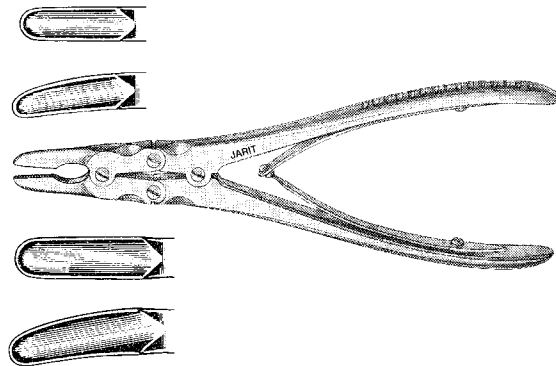

**Molt Periosteal Elevator**  
(Also referred to as Molt #9)

Catalog #	Description
380-315	7¼" (184mm), double-ended, 6.1mm x 7.2mm

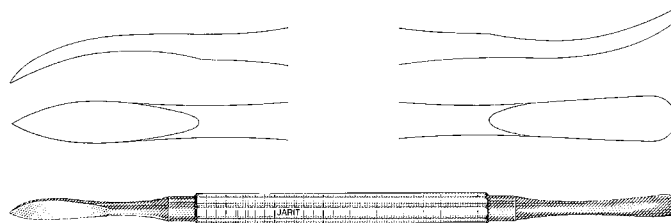

**Seldin Periosteal Elevator #23**

Catalog #	Description
250-509	7¾" (200mm), double-ended, blades ½" x 2⅛" (13mm x 55mm) and ⅜" x 2" (10mm x 51mm)



**Lempert Elevators**  
7" (175mm), slight angle

Catalog #	Description
380-320	2mm wide
380-321	3mm wide

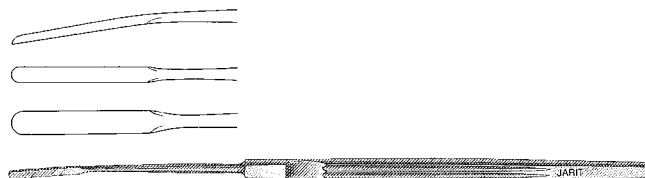

**Lempert Elevator**

Catalog #	Description
380-323	7¼" (184mm), curved blade, 7mm wide

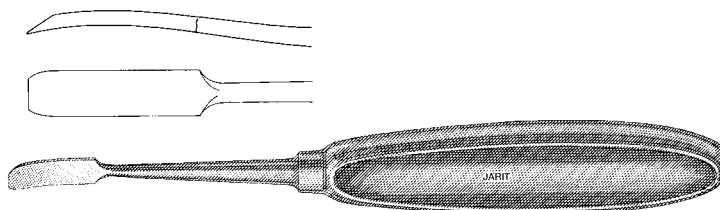



### Periosteal Nasal Elevator

Catalog #	Description
380-325	8" (203mm), heavy, curved blade, 7mm wide

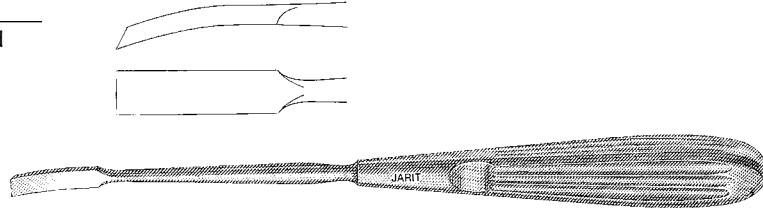

### Henner Elevator

Catalog #	Description
380-330	7 1/2" (190mm), double-ended, 2mm wide

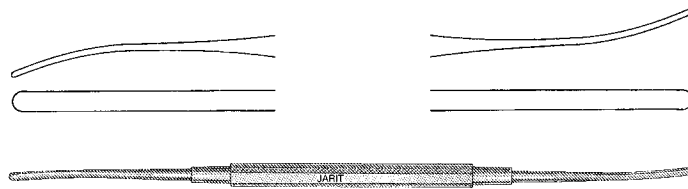

### Farrell Applicator

Catalog #	Description
380-335	5½" (140mm), triangular end 18mm

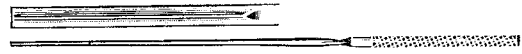

### Farrell Applicator

Catalog #	Description
380-336	5½" (140mm), roughened end 18mm



### Buck Applicator

Catalog #	Description
380-340	6¼" (159mm), triangular end 18mm

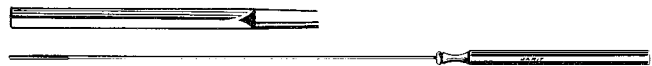

### Brown Applicator

Catalog #	Description
380-350	6" (152mm), triangular end, copper 18mm



### Uebe Applicator

Catalog #	Description
380-355	7" (180mm), twisted end

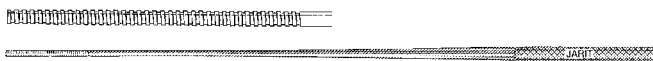

### Uebe Applicator

Catalog #	Description
380-356	6 1/4" (160mm), triangular end

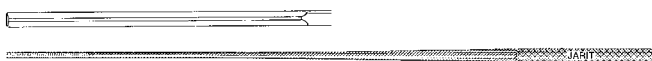

### Pomerooy Ear Syringes

all metal, with one tapered tip and one bulbous tip

Catalog #	Description
380-360	2 ounce (60cc) capacity 3" (75mm)
380-362	4 ounce (120cc) capacity 4 7/8" (125mm)
380-365	Protective shield
380-366	Tapered tip
380-367	Bulbous tip

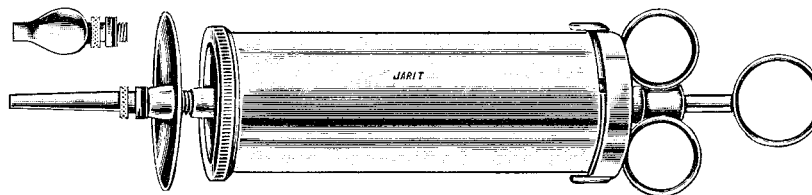

380-LOR-360	Replacement Large O-Ring Pkg/3ea
380-SOR-360	Replacement Small O-Ring Pkg/3ea
380-LOR-362	Replacement Large O-Ring Pkg/3ea
380-SOR-362	Replacement Small O-Ring Pkg/3ea

### House Suction Adapter

Catalog #	Description
385-025	House Suction Adapter



### House Suction Irrigators with thumb plate and cut-off

Catalog #	Description
385-030	2 x 2.5 FR, 5 <sup>3</sup> / <sub>8</sub> " (138mm) overall length, 90mm working length
385-031	2.5 x 4 FR, 5 <sup>3</sup> / <sub>8</sub> " (138mm) overall length, 75mm working length
385-032	2.5 x 4 FR, 6 <sup>1</sup> / <sub>2</sub> " (165mm) overall length, 100mm working length
385-033	4 x 5 FR, 5 <sup>3</sup> / <sub>8</sub> " (138mm) overall length, 72mm working length
385-034	4 x 5 FR, 6 <sup>1</sup> / <sub>2</sub> " (165mm) overall length, 100mm working length
385-035	5 x 7 FR, 6 <sup>1</sup> / <sub>2</sub> " (165mm) overall length, 100mm working length
385-036	6 x 8 FR, 6 <sup>1</sup> / <sub>2</sub> " (165mm) overall length, 100mm working length
385-037	7 x 10 FR, 6 <sup>1</sup> / <sub>2</sub> " (165mm) overall length, 100mm working length
385-038	8 x 12 FR, 6 <sup>1</sup> / <sub>2</sub> " (165mm) overall length, 100mm working length
385-039	12 x 14 FR, 6 <sup>1</sup> / <sub>2</sub> " (165mm) overall length, 100mm working length

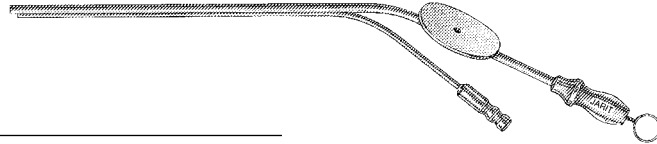

### Rosen Suction Tubes

4" (101mm) overall length, 60mm working length

Catalog #	Description
385-040	14 gauge
385-041	15 gauge
385-042	16 gauge
385-043	17 gauge
385-044	18 gauge
385-045	19 gauge
385-046	20 gauge
385-047	22 gauge
385-048	24 gauge
385-049	26 gauge



### Bellucci Suction Tube

Catalog #	Description
385-050	105mm working length, complete with 18, 20, and 22 gauge tips, thumb-plate and cut-off

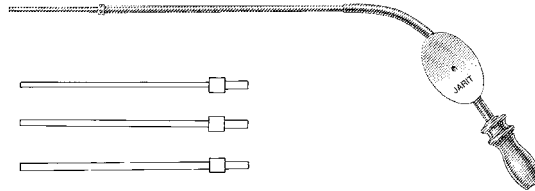

### Bellucci Tips only

1" (25mm)

Catalog #	Description
385-051	18 gauge
385-052	20 gauge
385-054	22 gauge
385-055	24 gauge
385-056	26 gauge

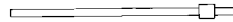

### Bellucci Cannula only

Catalog #	Description
385-058	4 1/2" (115mm)

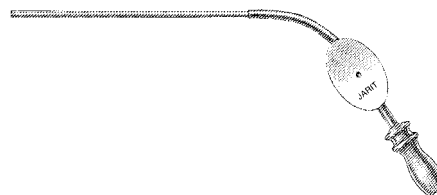

### Anthony Suction Tubes

5 7/8" (149mm)

Catalog #	Description
385-060	Small: 2mm lumen at tip
385-062	Large: 3mm lumen at tip

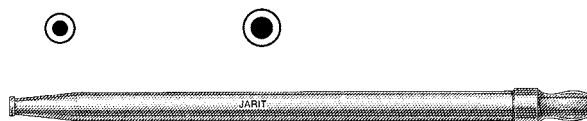

**Baron Suction Tubes**

5½" (140mm) overall length, 3" (75mm) working length

Catalog #	Description
385-080	3 French
385-082	5 French
385-084	7 French
385-STY-080	Replacement Stylet Pkg/3ea

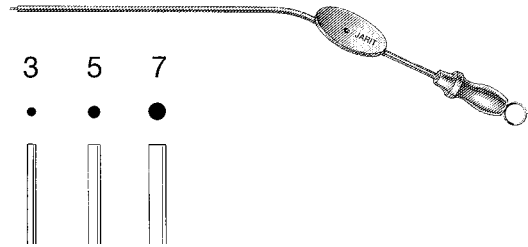

**Frazier Suction Tubes**

7½" (190mm) overall length, 4½" (114mm) working length

Catalog #	Description
285-449	5 French
285-450	6 French
285-451	7 French

\*For stylets (angled Frazier Suction Tube only) add the letter "S" to catalog number.

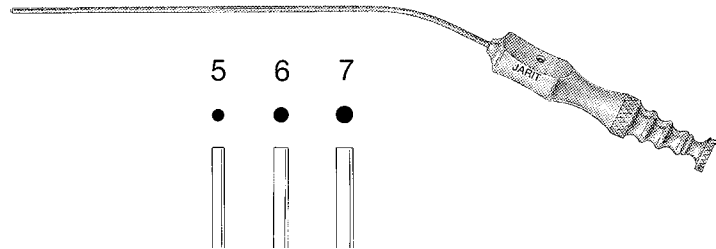

**Baron Suction Tubes**

6½" (165mm) overall length, 4" (100mm) working length

Catalog #	Description
285-480	3 French
285-482	5 French
285-484	7 French

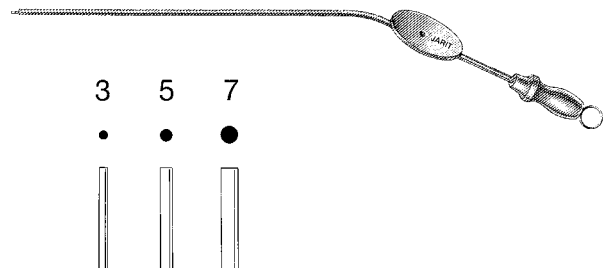

### House Alligator Ear Forceps

3 7/8" (80mm) working length, serrated jaws, 0.9mm x 4mm  
(details shown left to right)

Catalog #	Description
385-100	Straight
385-102	Up-angled
385-104	Down-angled
385-106	Left curved
385-108	Right curved

385-110 Side opening to right,  
3 1/4" (82mm) working length,  
serrated jaws, 0.9mm x 5.5mm  
(details shown on far right)

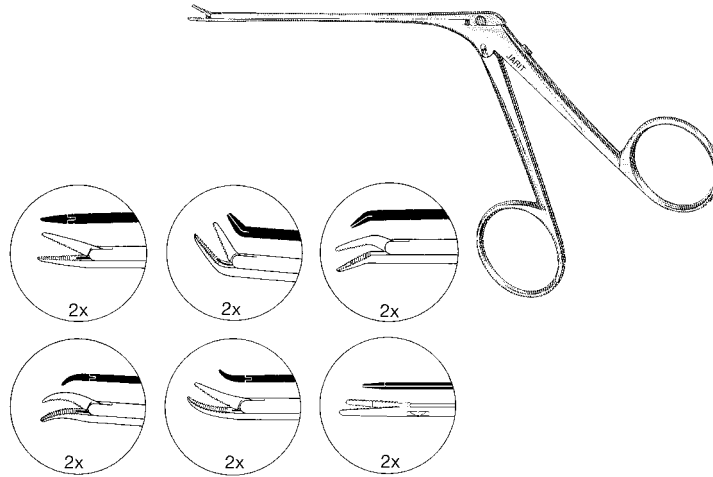

### House Crimper Forceps

Catalog #	Description
385-115	3 3/8" (87mm) working length, flat tapered serrated jaws .75mm x 8mm

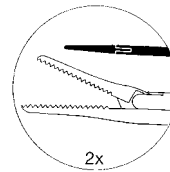

### House Alligator Ear Forceps

3 1/4" (82mm) working length, serrated jaws

Catalog #	Description
385-120	Fine, .09mm x 5mm jaws
385-121	Delicate, .08mm x 4mm jaws

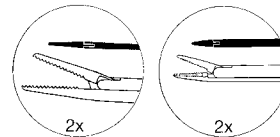

### House Miniature Cup Forceps

3 1/4" (82mm) working length, oval cups 0.6mm x 1mm

Catalog #	Description
385-125	Straight
385-126	Angled left
385-127	Angled right

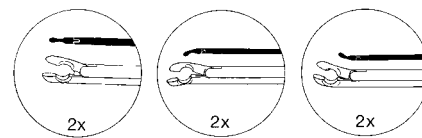

### House Strut Forceps

Catalog #	Description
385-130	3 1/8" (80mm) working length, smooth jaws, 0.8mm x 4mm

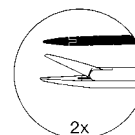

**House Alligator Ear Forceps**

3/4" (82mm) working length, oval cups 0.9mm x 1mm

Catalog #	Description
385-140	Straight
385-142	Up-angled
385-144	Down-angled
385-146	Left curved angled
385-148	Right curved angled

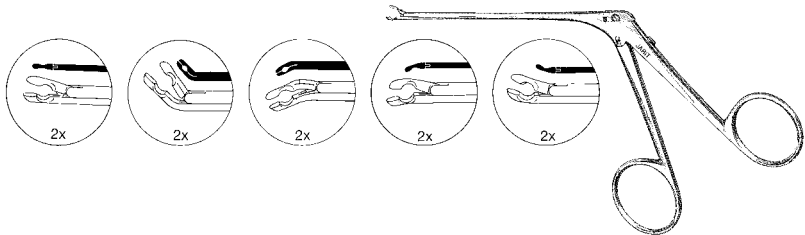

**Bellucci Alligator Scissors**

3 3/8" (87mm) working length

Catalog #	Description
385-200	Straight, 8mm blades
385-202	Up-angled, 6mm blades
385-204	Left curved, 8mm blades
385-206	Right curved, 8mm blades

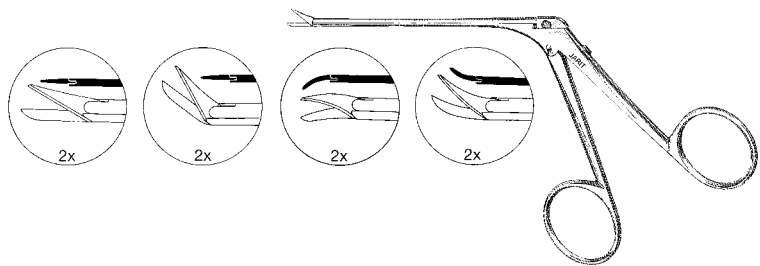

**House-Bellucci Alligator Scissors**

3 3/8" (87mm) working length, 5mm blades

Catalog #	Description
385-210	Straight
385-211	Left curved
385-212	Right curved

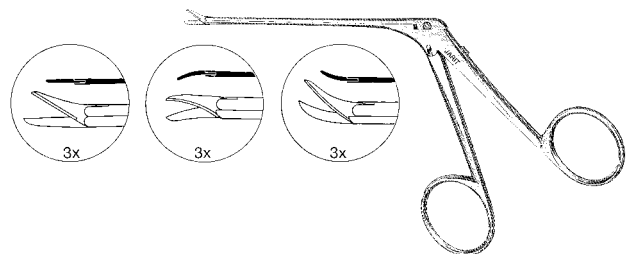

**Micro Alligator Ear Forceps**

3 1/8" (78mm) shaft

Catalog #	Description
385-220	Serrated jaws 0.6mm wide, ebony finish
385-221	Serrated jaws 0.8mm wide, ebony finish





**Micro Alligator Ear Forcep**

3 1/8" (78mm), Oval

Catalog #	Description
385-223	Oval cup jaws 0.5mm wide, ebony finish
385-224	Oval cup jaws 0.8mm wide, ebony finish



**House-Dieters Malleus Nippers**

3 1/4" (82mm) working length

Catalog #	Description
385-240	Large
385-242	Small

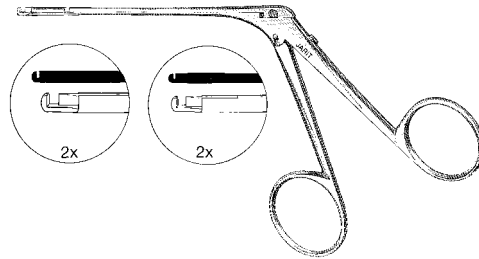

**Hough Crura Nippers**

3 1/8" (80mm) working length, 3mm jaws, 45° angle

Catalog #	Description
385-245	Left
385-246	Right

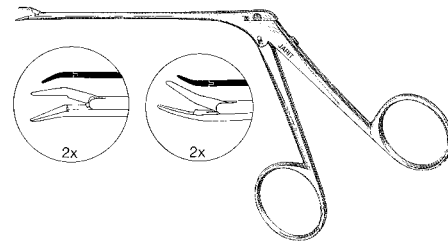

**McGee Wire Closure Forceps**

Catalog #	Description
385-250	3 1/4" (82mm) working length, .09mm x 3mm jaws

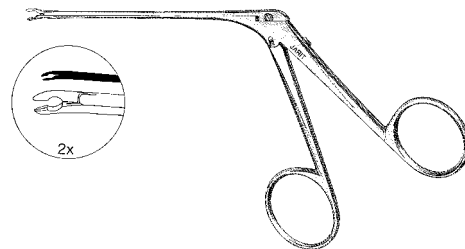

**McGee Malleus Crimper or Wire Closure Forceps**

Catalog #	Description
385-252	3 1/4" (82mm) working length, .09mm x 3mm jaws

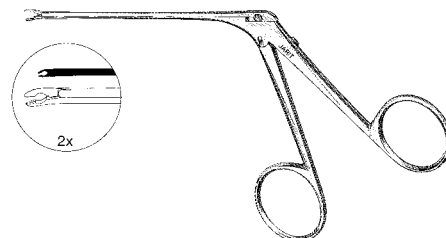

**Jansen Retractors**

3" (76mm)

Catalog #	Description
290-100	3 x 3 sharp prongs, 13mm deep blades
290-101	3 x 3 blunt prongs, 13mm deep blades

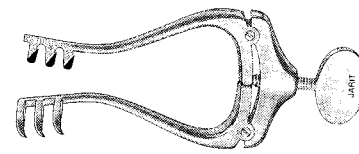

**Jansen Retractor**

Catalog #	Description
290-102	3 3/4" (94mm), 4 x 4 blunt prongs, 22mm deep blades

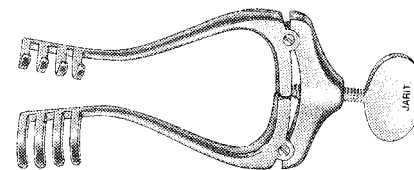

**Perkins Retractors**

4 7/8" (125mm), curved arms

Catalog #	Description
385-257	3 semi-sharp prongs, 13mm deep, on right, 12.5mm x 25mm solid blade with teeth on left
385-258	3 semi-sharp prongs, 13mm deep, on right, 12.5mm x 25mm solid blade with teeth on right

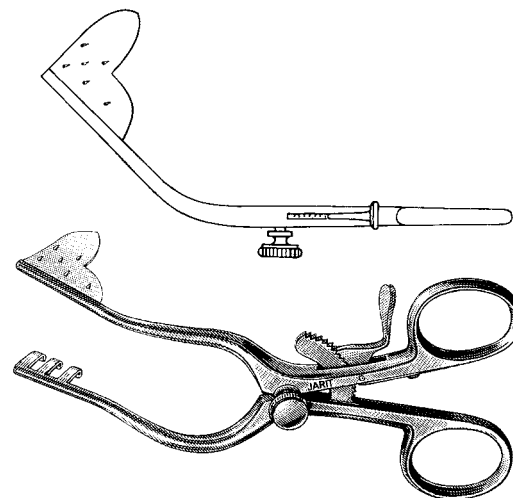

### Wullstein Retractor

Catalog #	Description
385-260	5" (127mm), curved arms, 3 x 3 sharp prongs, 13mm wide x 17mm deep

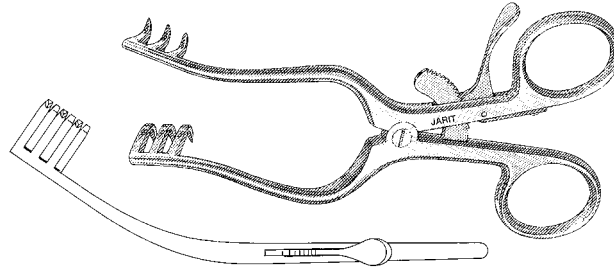

### Weitlaner Retractor

Catalog #	Description
385-262	4 1/8" (105mm), curved arms, 3 x 3 blunt prongs, 12mm wide x 16mm deep

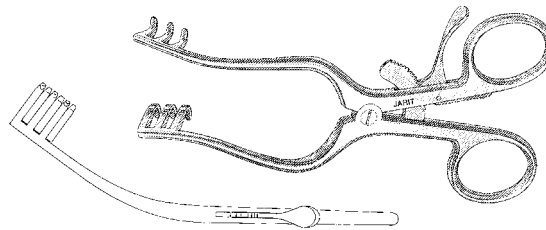

### Bellucci-Wullstein Retractors

5 1/8" (130mm) curved arms

Catalog #	Description
385-265	2 semi-sharp prongs, 13mm deep, on right, 10mm x 25mm solid blade on left
385-266	2 blunt prongs, 13mm deep, on left, 10mm x 25mm solid blade on right

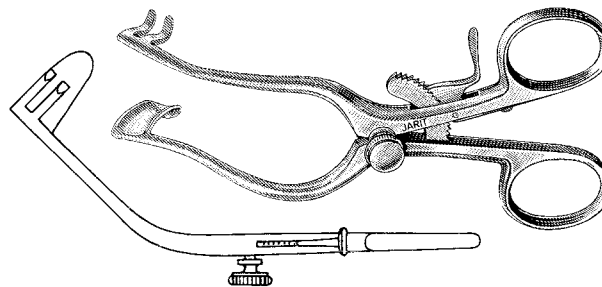

### House Hand Retractor

Catalog #	Description
385-270	6" (152mm), double-ended, Small blade: 1/4" x 3/4" (65mm x 20mm), Large blade: 3/8" x 1" (8.75mm x 25mm)

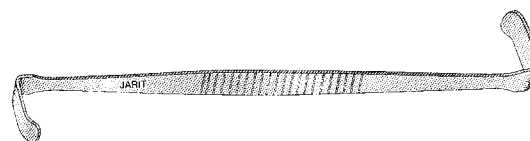

**Guilford Scissors**

Catalog #	Description
385-280	3¾" (95mm), 12mm blades, one blade serrated

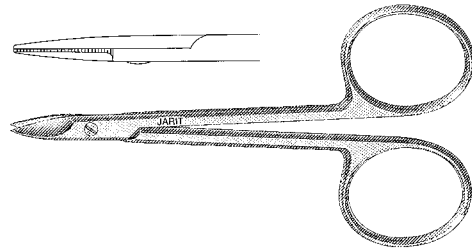

**Shea Vein Graft Scissors**

Catalog #	Description
385-285	4⅜" (118mm), curved, 9mm flat dissecting tips

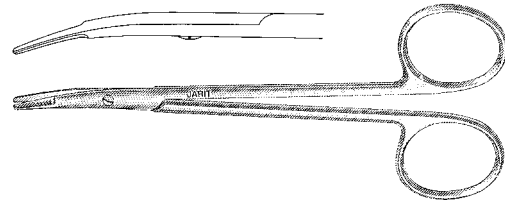

**House Middle Ear Mirror**

Catalog #	Description
385-305	6¾" (171mm), 2mm diameter, 45° angle

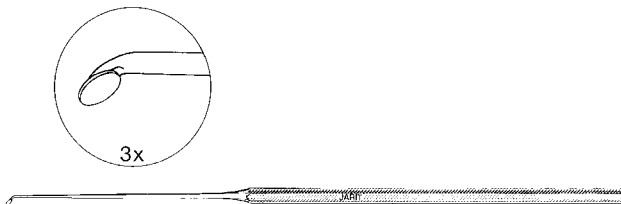

**House Obtuse Pick**

Catalog #	Description
385-310	6¼" (157mm), malleable shaft, 0.25mm tip, 30° angle

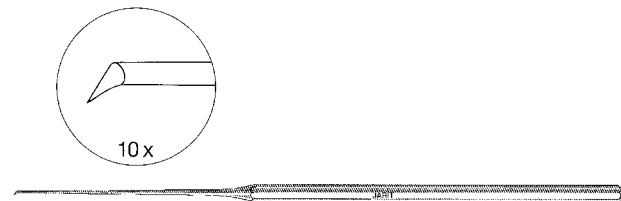

**House Hooks**

6⅝" (168mm), angled malleable shaft, 1mm tips

Catalog #	Description
385-315	90° left angled
385-316	90° right angled

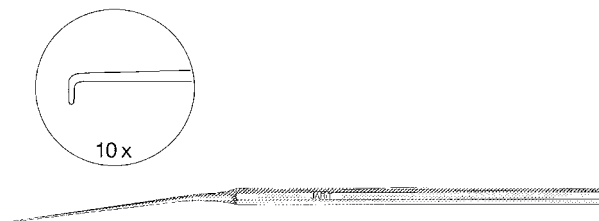

### House Needle

Catalog #	Description
385-317	6 <sup>5</sup> / <sub>8</sub> " (168mm), malleable shaft, semi-sharp curved tip

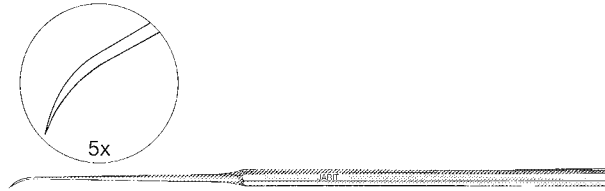

### House-Sheehy Knife Curettes

6<sup>5</sup>/<sub>8</sub>" (168mm), malleable shaft

Catalog #	Description
385-320	"Small weapon", 2mm semi-sharp blade
385-321	"Large weapon", 2.5mm semi-sharp blade

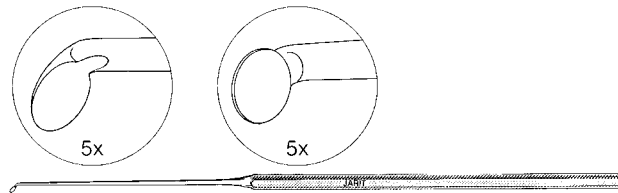

### House-Rosen Needle

Catalog #	Description
385-326	6 <sup>1</sup> / <sub>4</sub> " (156mm), malleable shaft, semi-sharp tip, 3mm full curve from tip

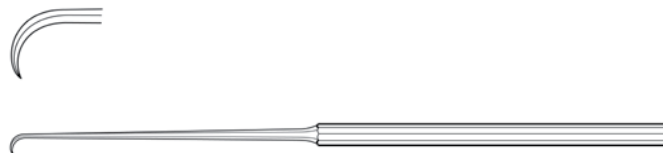

### House-Rosen Needle

Catalog #	Description
385-327	6 <sup>1</sup> / <sub>4</sub> " (158mm), malleable shaft, 2.9mm semi-sharp curved tip

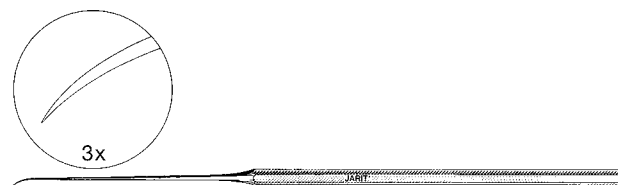

### House Footplate Chisel

Catalog #	Description
385-330	6 5/8" (168mm), angled malleable shaft, 0.6mm tip

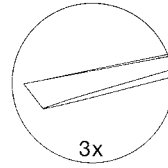

### House-Hough Excavator

Catalog #	Description
385-335	6 5/8" (168mm), malleable shaft, 0.25mm tip, 90° angle

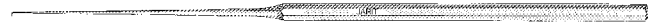
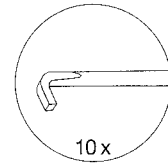

### House Wire Strut Guide

Catalog #	Description
385-340	6 1/8" (156mm), angled, malleable shaft, 0.6mm tip with notched end

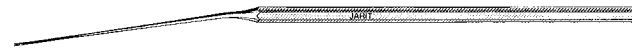
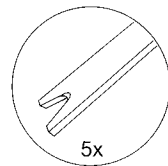

### House Strut Calipers

6" (154mm), malleable shaft

Catalog #	Description
385-345	Marker 3.5mm from tip
385-346	Marker 4mm from tip
385-347	Marker 4.5mm from tip
385-348	Marker 5mm from tip

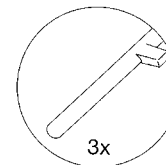
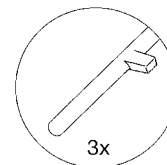
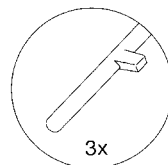
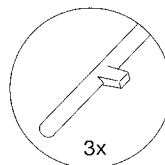

### House-Barbara Pick

Catalog #	Description
385-350	6 <sup>5</sup> / <sub>8</sub> " (168mm), malleable shaft, straight tip

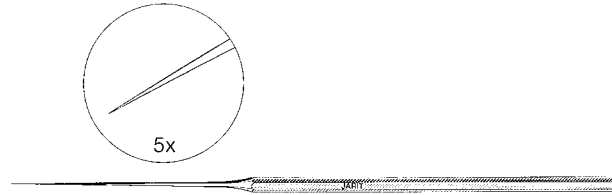

### House Oval Window Picks

6<sup>5</sup>/<sub>8</sub>" (168mm), malleable shaft

Catalog #	Description
385-351	0.33mm tip, 30° angle
385-352	0.66mm tip, 30° angle
385-353	0.33mm tip, 90° angle, fine shaft
385-354	0.33mm tip, 90° angle, medium shaft

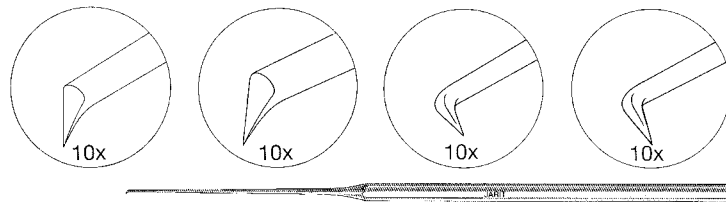

### House Strut Picks

6<sup>5</sup>/<sub>8</sub>" (168mm), malleable medium shaft, 90° angle

Catalog #	Description
385-355	0.5mm tip
385-356	0.66mm tip

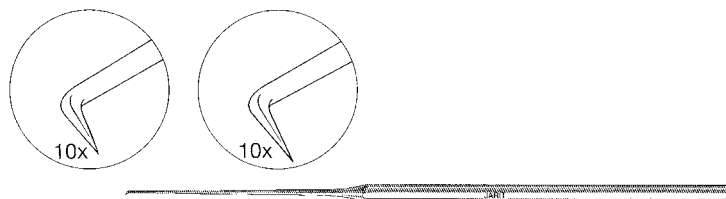

### House Picks

6<sup>5</sup>/<sub>8</sub>" (168mm), malleable heavy shaft, 90° angle

Catalog #	Description
385-360	1mm tip
385-361	1.5mm tip
385-362	3mm tip

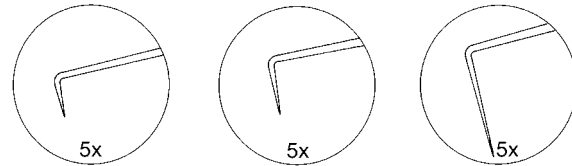

### House-Crabtree Dissector Pick "Jimmy"

Catalog #	Description
385-370	6 <sup>5</sup> / <sub>8</sub> " (168mm), 0.5mm x 2.5mm flat tip, 90° angle

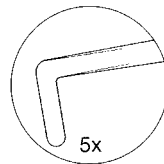

### House-Crabtree Dissector

Catalog #	Description
385-371	6 <sup>5</sup> / <sub>8</sub> " (168mm), 0.5mm x 1.5mm flat tip, 90° angle

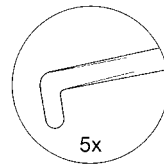

### House Elevator "Gimmick"

Catalog #	Description
385-380	6 <sup>5</sup> / <sub>8</sub> " (168mm), 1mm x 12mm blade, 15° angle

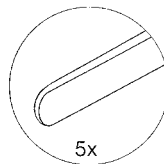



### House Tympanoplasty Knife

Catalog #	Description
385-382	6 <sup>5</sup> / <sub>8</sub> " (168mm), 7mm curved blade

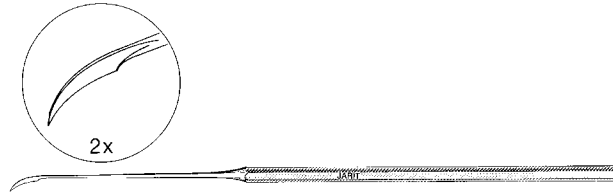

### House Lancet Knife "Number Two Knife"

Catalog #	Description
385-384	6 <sup>5</sup> / <sub>8</sub> " (168mm), 2mm x 3mm tapered blade, 45° angle

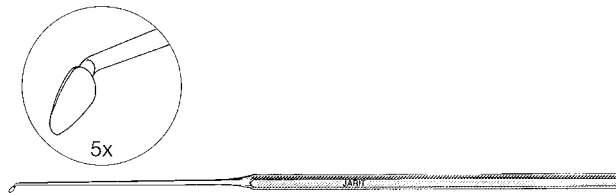

### House Incudostapedial Joint Knife

Catalog #	Description
385-386	6 <sup>5</sup> / <sub>8</sub> " (168mm), 0.75mm blade, 60° angle

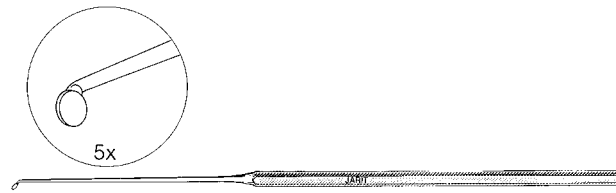

### House Incudostapedial Joint Knife

Catalog #	Description
385-388	6 <sup>5</sup> / <sub>8</sub> " (168mm), 0.5mm x 1.5mm blade, 20° angle

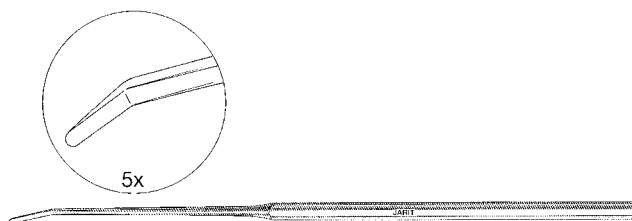

### House Sickle Knife "Number One Knife"

Catalog #	Description
385-390	6 <sup>5</sup> / <sub>8</sub> " (168mm), 8mm curved blade

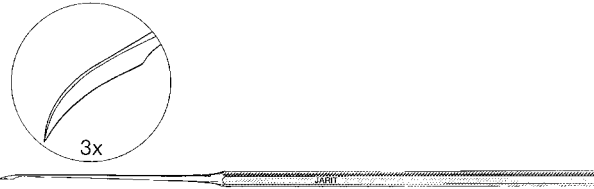

### House Myringotomy Knife

Catalog #	Description
385-392	6 <sup>5</sup> / <sub>8</sub> " (168mm), 3.5mm blade

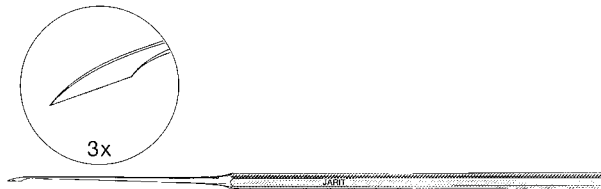

### House Curettes

7" (180mm), double-ended, 2mm x 2.5mm and 2.25 x 3mm cups

Catalog #	Description
385-400	Light angle
385-401	Strong angle

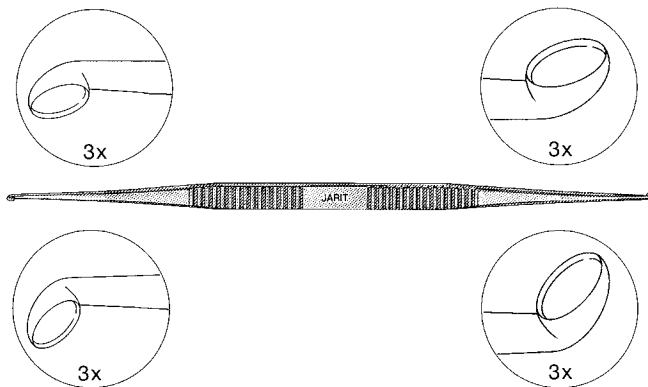

### House Stapes Curette

Catalog #	Description
385-402	6" (152mm), double-ended. 2mm x 2.5mm and 2.25 x 3mm cups, 35° angle



### Derlacki Ossicle Holding Clamp

Catalog #	Description
385-430	4 <sup>7</sup> / <sub>8</sub> " (124mm), 1.5mm x 4mm vertical groove and 1.5mm x 2mm horizontal groove

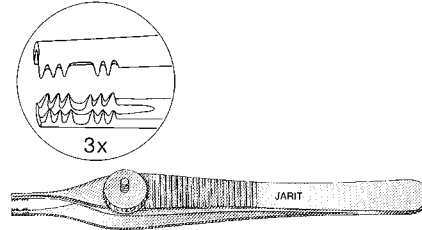

### Sheehy Ossicle Holding Clamp

Catalog #	Description
385-440	4 <sup>3</sup> / <sub>4</sub> " (121mm), 1.5mm x 4mm vertical groove

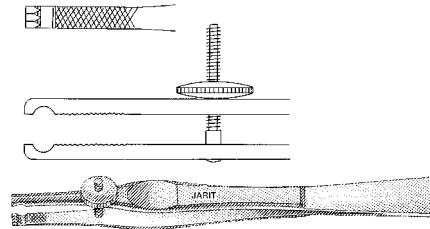

### Sheehy Fascia Press

Catalog #	Description
385-500	7 <sup>1</sup> / <sub>2</sub> " (192mm), 23mm x 31mm plates

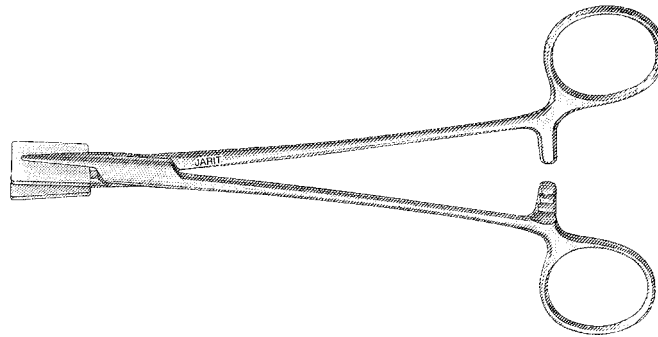

### Gel Foam Presses

Catalog #	Description
385-505	5 <sup>1</sup> / <sub>8</sub> " (130mm), 12mm x 15mm plates
385-506	7 <sup>1</sup> / <sub>2</sub> " (190mm), 12mm x 16mm plates

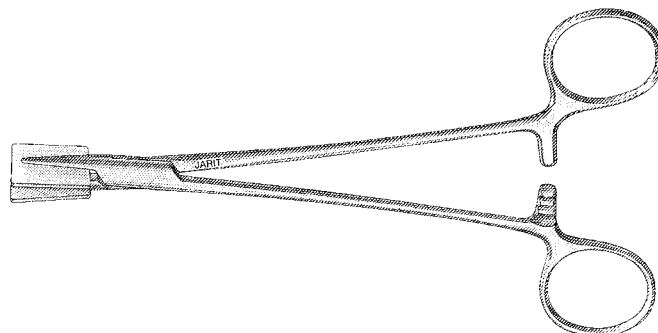

**Vienna Nasal Specula**

5 3/8" (138mm), original pattern

Catalog #	Description
400-100	Small: 29mm blades
400-101	Medium: 30mm blades
400-102	Large: 33mm blades

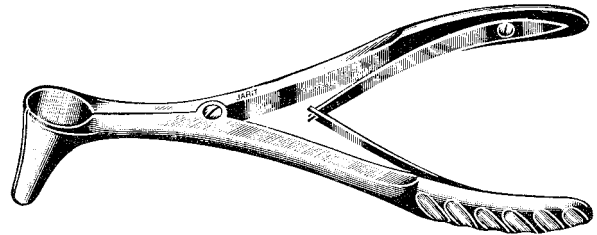

**Sonnenschein Nasal Speculum**

Catalog #	Description
400-105	6 1/4" (156mm), 29mm blades

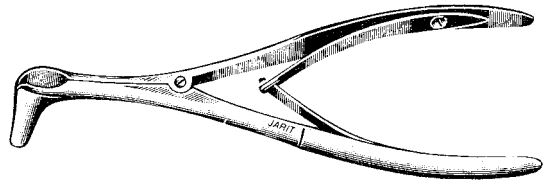

**Tiek-Halle Infant Nasal Speculum**

Catalog #	Description
400-110	5 1/8" (130mm), 17mm blades

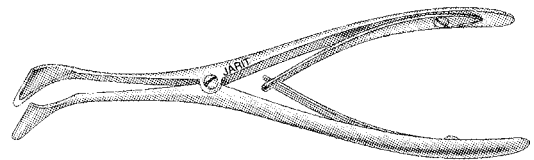

**Beckman Nasal (Endaural) Speculum**

Catalog #	Description
400-112	5 3/4" (146mm), side curved, 28.5mm blades

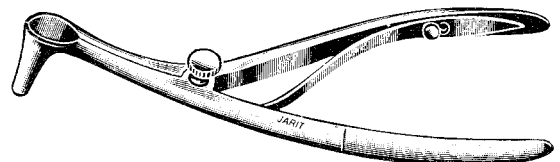

### Vienna Nasal Specula

5½" (140mm), conventional blades

Catalog #	Description
400-115	Small: 27.5mm blades
400-116	Medium: 32.5mm blades
400-117	Large: 33mm blades

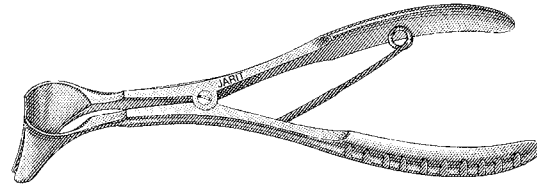

### Vienna Nasal Specula

5½" (140mm), modified blades

Catalog #	Description
400-120	Small: 27.5mm blades
400-121	Medium: 32.5mm blades
400-122	Large: 33mm blades

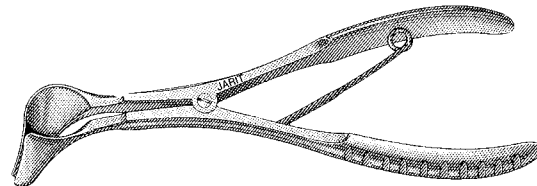

### Killian Septum Specula

Catalog #	Description
400-130	5¾" (136mm), 50mm blades
400-131	5¾" (145mm), 65.5mm blades
400-132	5¾" (148mm), 76.5mm blades
400-134	6" (153mm), 91mm blades

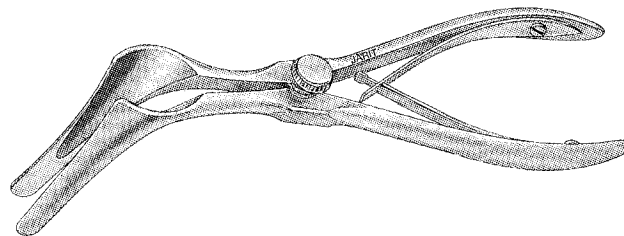

### Hartman Nasal Speculum

Catalog #	Description
400-135	6¼" (160mm), 33.5mm blades

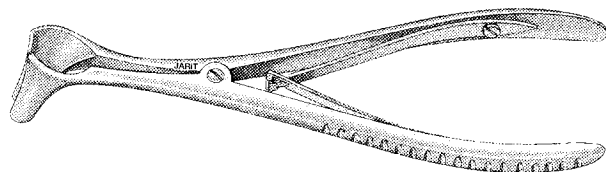

**Cottle Septum Speculum**

Catalog #	Description
400-136	5 1/2" (140mm), 50mm thin blades, tapered to 3.4mm
400-SPS-136	Replacement Spring

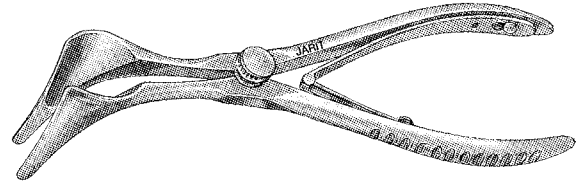

**Cottle Septum Speculum**

narrow tapered blades

Catalog #	Description
400-140	Size 1: 5 3/8" (135mm), 32mm blades, tapered 9mm to 4.5mm wide
400-141	Size 2: 5 1/2" (140mm), 35mm blades, tapered 10mm to 8mm wide
400-142	Size 3: 5 7/8" (146mm), 55mm blades, tapered 10mm to 6mm wide
400-143	Size 4: 5 7/8" (146mm), 55mm blades, tapered 10mm to 7.5mm wide
400-144	Size 5: 6 1/8" (155mm), 70mm blades, tapered 10mm to 7mm wide
400-145	Size 6: 6 1/4" (160mm), 80mm blades, tapered 10mm to 8mm wide
400-146	Size 7: 6 1/2" (165mm), 90mm blades, tapered 10mm to 8mm wide

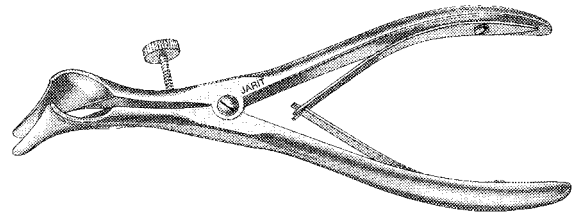

### Jansen Nasal Dressing Forceps

Catalog #	Description
400-150	7¾" (195mm), 18mm serrated tip

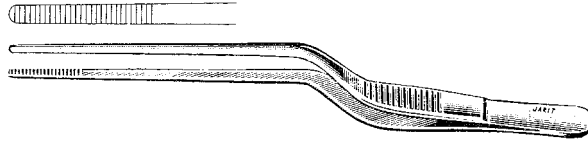

### Gruenwald Nasal Dressing Forceps

Catalog #	Description
400-152	8½" (214mm), 20mm serrated tip

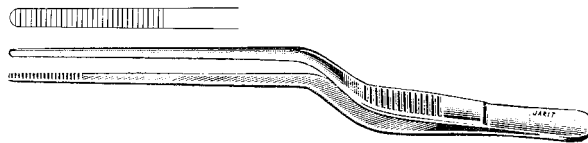

### Wilde Nasal Dressing Forceps

Catalog #	Description
400-155	6¼" (158mm), 15.5mm serrated tip

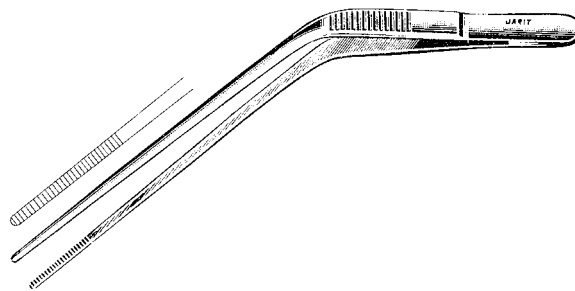

**Hartman Nasal Dressing Forceps**

3 1/2" (90mm) working length

Catalog #	Description
400-160	Delicate, 3.1mm wide x 13mm length tip
400-161	Regular, 3.7mm wide x 16mm length tip

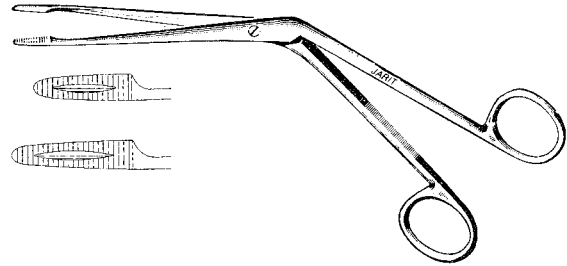

**Noyes Nasal Dressing Forceps**

5 1/2" (90mm) working length

Catalog #	Description
400-170	Serrated jaws, 2.4mm wide x 16mm length tip
400-171	1 x 2 teeth, 3.5mm wide x 16mm length tip

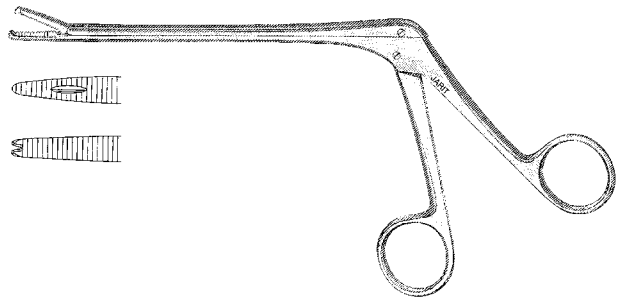

**Knight Nasal Dressing Forceps**

Catalog #	Description
400-175	2 1/4" (57mm) working length, serrated jaws 4.3mm wide x 15mm length

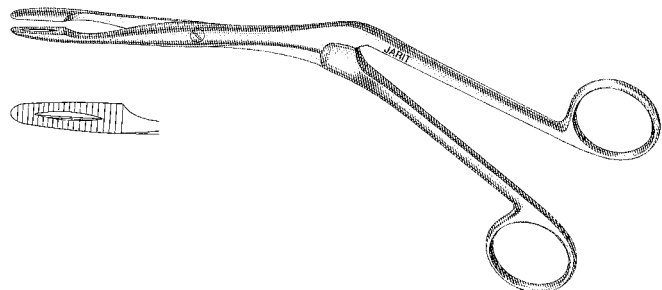



**Seiler Turbinate Scissors**

Catalog #	Description
400-177	6½" (163mm), 72mm blades

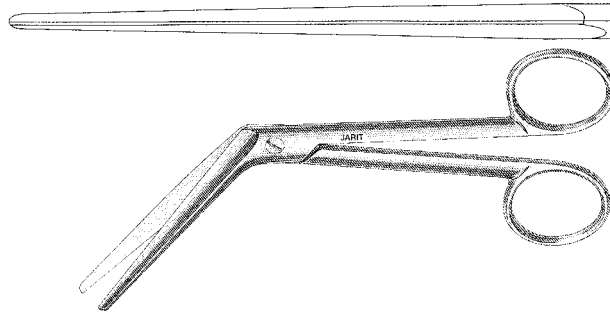

**Knight Nasal Scissors**

Catalog #	Description
400-180	6¼" (161mm), 33mm blades

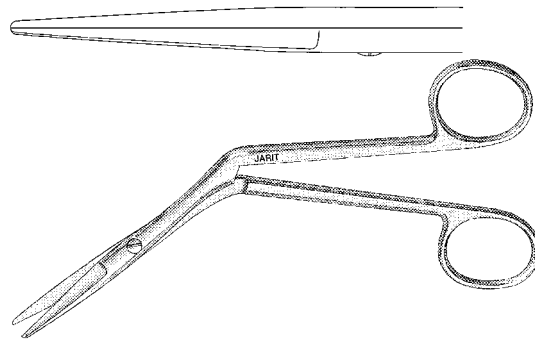

**Knight Nasal Scissors, Supercut**

Catalog #	Description
102-180	6¼" (161mm), 33mm blades

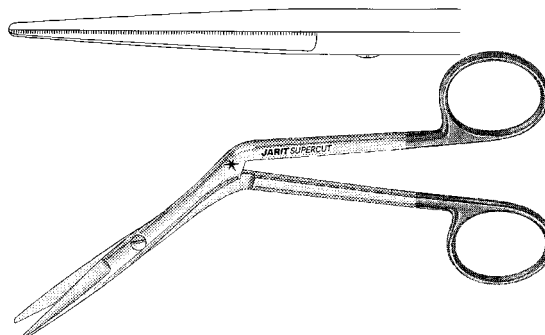

**Joseph Scissors**

Catalog #	Description
100-278	5⅝" (143mm), straight
100-279	5⅝" (143mm), curved

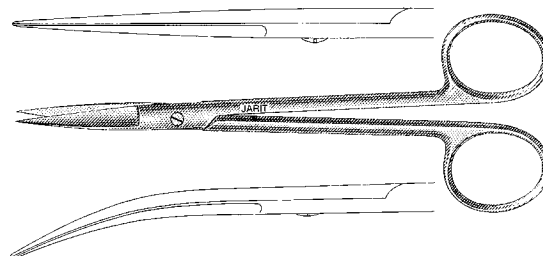

**Krause Nasal Snare**

Catalog #	Description
400-185	10" (255mm), includes 1 package of 12 snare wires, 28 gauge
400-STY-185	Replacement Stylet pkg/3ea
400-TUB-185	Replacement Tube Only

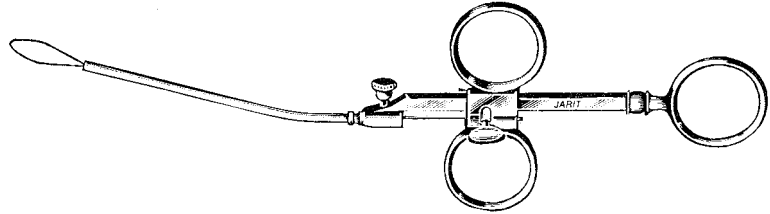

**Bruening Nasal Snare**

Catalog #	Description
400-187	8¾" (223mm), includes 1 package of 12 snare wires, 28 gauge
400-STY-187	Replacement Stylet pkg/3ea

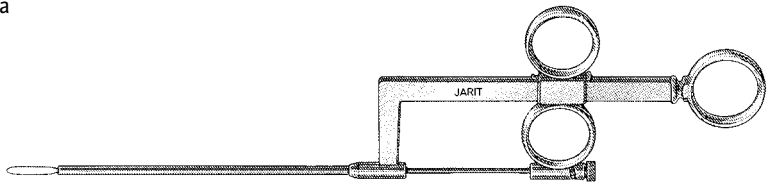

### Van Alyea Frontal Sinus Cannula

Catalog #	Description
400-200	6" (151mm), light curve, silver

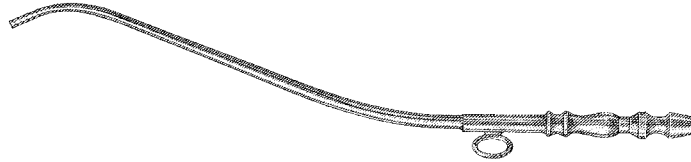

### Lichtwicz Antrum Trocar Needle

Catalog #	Description
400-220	4½" (114mm), 16 gauge with crossbar

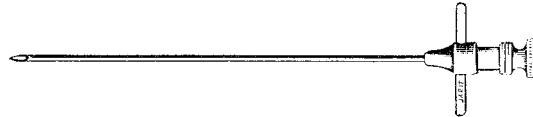

### Ruskin Antrum Trocar Needles

4⅛" (105mm), 14 gauge with crossbar

Catalog #	Description
400-222	Straight
400-223	Curved

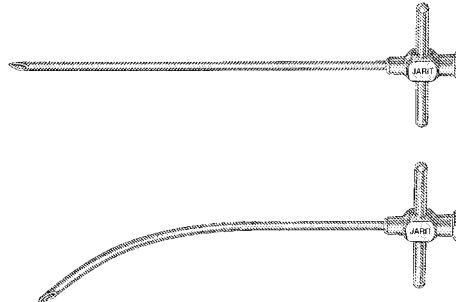

### Coakley Antrum Trocars

6¼" (159mm), with cannula and irrigating extension

Catalog #	Description
400-225	Light curve
400-226	Strong curve

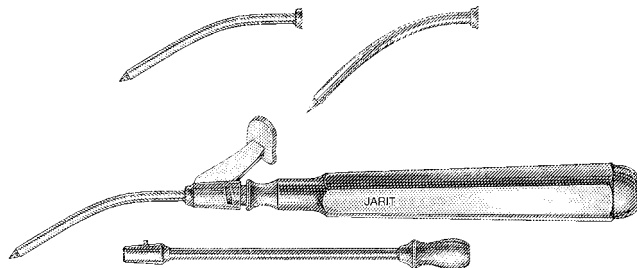

**Killian (Von Eicken) Antrum Cannula**

Catalog #	Description
440-230	5 1/2" (140mm), 3.8mm

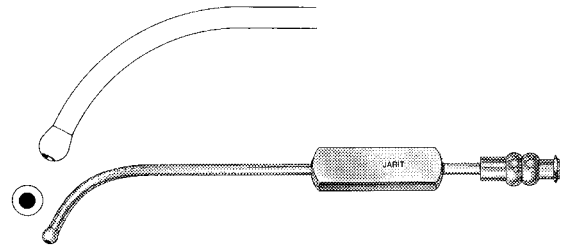

**Wiener Antrum Rasps**

7 3/4" (196mm)

Catalog #	Description
400-234	Small: trocar tip, 3mm
400-235	Medium: trocar tip, 4mm
400-236	Large: trocar tip, 5mm
400-237	Large: blunt tip, 5mm

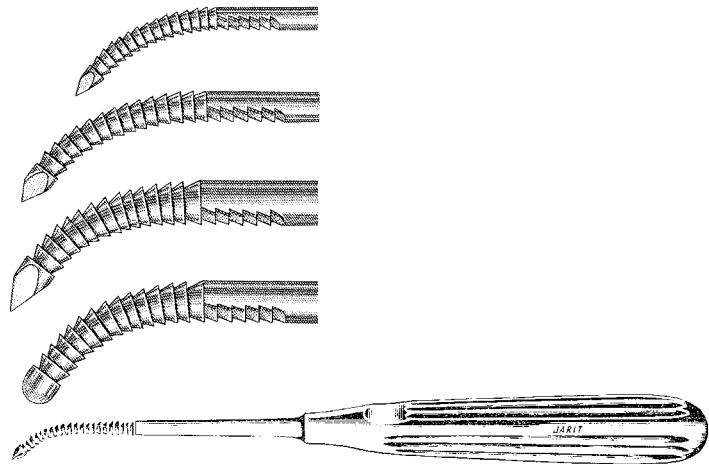

### Ballenger V-Shaped Chisels

6¼" (160mm)

Catalog #	Description
400-240	2mm
400-241	4mm
400-242	6mm
400-243	8mm

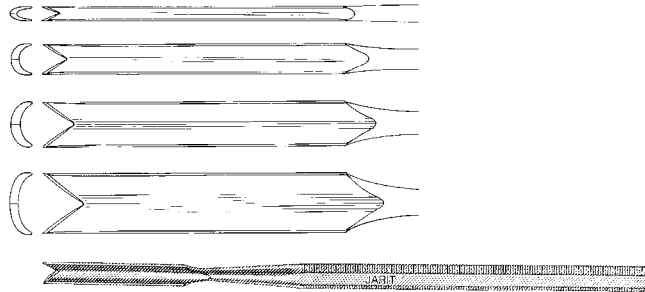

### West Lacrimal Sac Chisel

Catalog #	Description
400-245	7½" (190mm), 6mm



### West Lacrimal Sac Gouge

Catalog #	Description
400-247	7½" (190mm), 6mm



### Freer Septum Knife

Catalog #	Description
400-250	7½" (188mm), 5mm angled blade



**Pierce Elevator**

Catalog #	Description
400-253	8 1/4" (210mm), double-ended, 5.7mm x 6mm blades

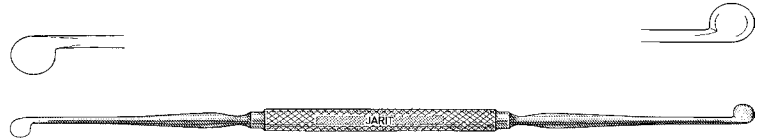

**Freer Septum Knife**

Catalog #	Description
400-255	6 1/2" (165mm), 5mm x 8mm "D" shaped knife



**Freer Chisels**

6 1/2" (165mm), 4mm x 10mm wide

Catalog #	Description
400-257	Straight
400-258	Curved



**Ballenger Swivel Knives**

8 1/4" (212mm), straight

Catalog #	Description
400-260	3mm
400-261	4mm
400-262	5mm



**Ballenger Swivel Knives**

8" (202mm), bayonet

Catalog #	Description
400-263	3mm
400-264	4mm
400-265	5mm

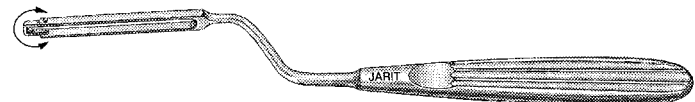

### Cottle-McKenty Elevator

Catalog #	Description
400-269	8½" (215mm), double-ended, 3.5mm x 4.5mm wide blades

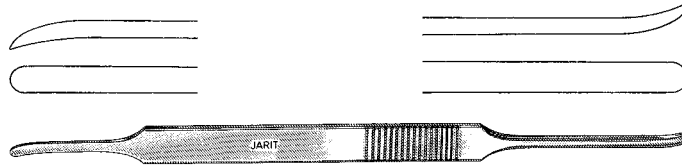

### McKenty Septal Elevators

6" (152mm)

Catalog #	Description
400-270	4mm wide blades
400-271	5mm wide blades

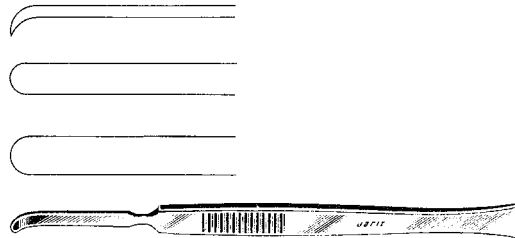

### Pennington Septal Elevator

Catalog #	Description
400-272	8¼" (209mm), double-ended, 4.2mm x 4.6mm wide blades

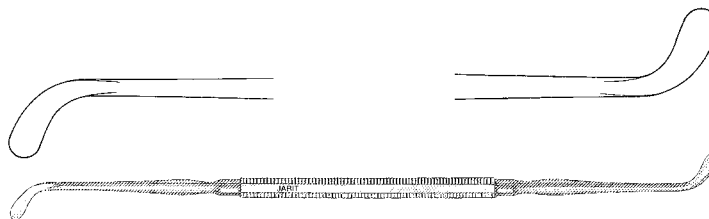

### Ostium Seeker Ball End Elevator

Catalog #	Description
400-273	7½" (190mm), double-ended, 2mm x 2.5mm diameter ball tips

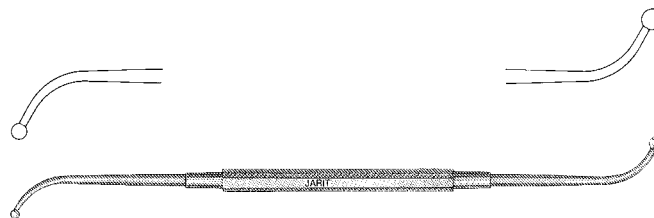

**Freer Septum Elevator**

7½" (190mm), single-ended

Catalog #	Description
400-274	5mm wide blade and 6mm wide round blade

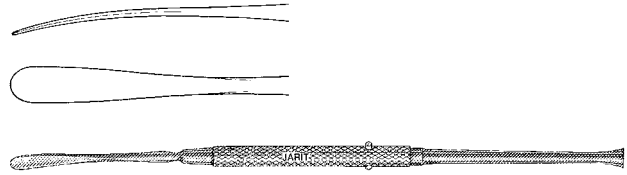

**Freer Septum Elevators**

7¾" (198mm), double-ended, sharp-blunt blades

Catalog #	Description
285-379	6.5mm wide blades
285-380	4.5mm wide blades

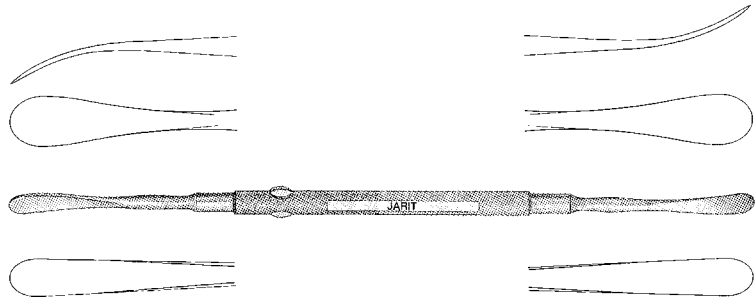

**Ballenger Septum Elevator**

Catalog #	Description
400-275	8¾" (222mm), double-ended, semi-sharp and blunt blades, 5.5mm wide

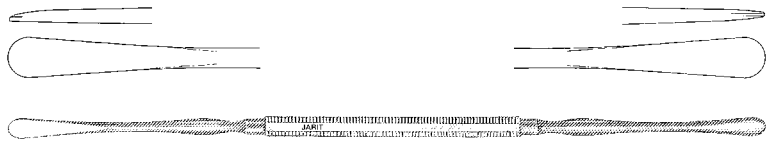

**Roger Elevator**

Catalog #	Description
400-276	8¼" (210mm), double-ended, 3mm wide

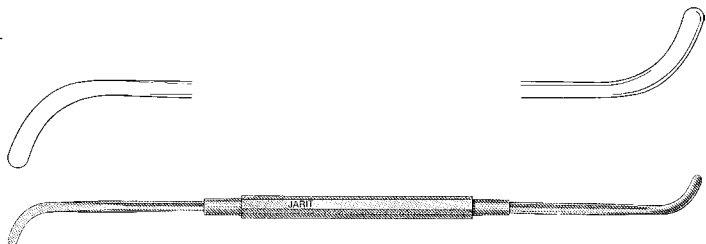



### Cottle Septum Elevator

Catalog #	Description
400-277	9" (226mm), double-ended, graduated, 4.6mm wide blade and 4.9mm wide round end

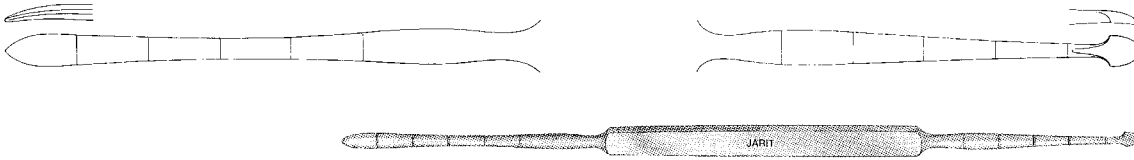

### Cottle Elevator

Catalog #	Description
400-278	9" (230mm), double-ended, for tunneling, 4.8mm and 5mm wide blades

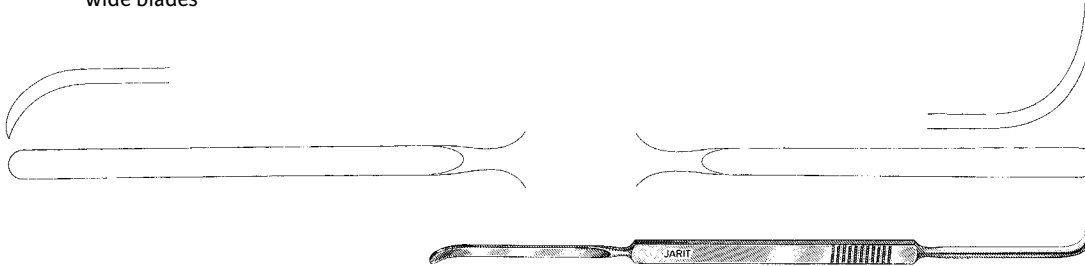

### Jarit Periosteal Elevators

6¼" (160mm), 5mm wide blade

Catalog #	Description
285-345	Blunt
285-346	Semi-sharp



### Boies Nasal Fracture Elevator

Catalog #	Description
400-279	7½" (190mm), 11mm wide blades

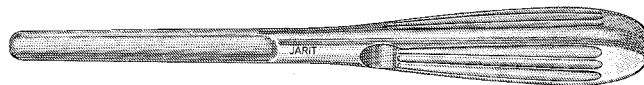

**Converse Periosteal Elevator**

Catalog #	Description
400-280	7¼" (184mm), 5mm wide blades

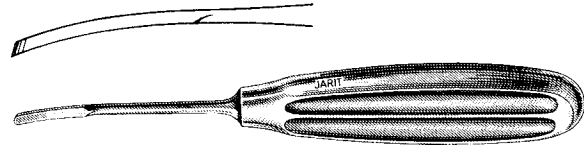

**Joseph Periosteal Elevator**

Catalog #	Description
400-281	6¾" (173mm), 4.2mm wide blade

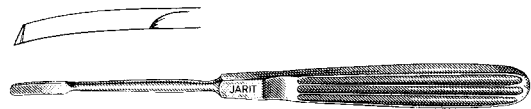

**Cottle Skin Elevator**

Catalog #	Description
400-282	7½" (190mm), 8mm wide blade

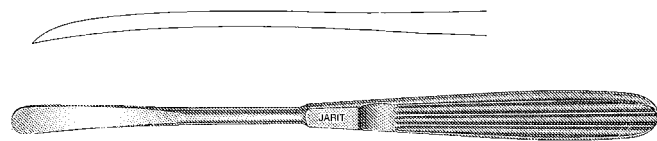

**Goldman Displacer Septum Elevator**

Catalog #	Description
400-285	7¾" (197mm), 6.7mm wide blade

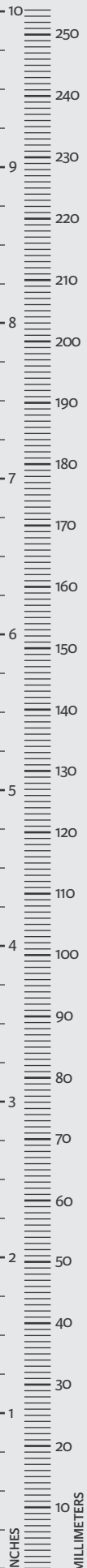
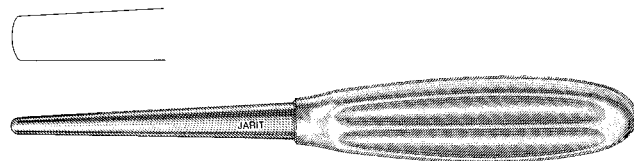

### Dingman Zygoma Elevator

Catalog #	Description
400-286	8¾" (225mm), 5.5mm wide, curved rounded blade

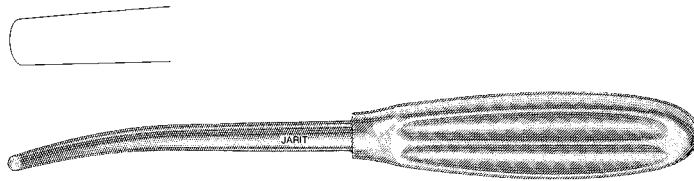

### Halle Elevators

7" (178mm)

Catalog #	Description
400-287	3mm blade
400-288	5mm blade



### Kleinert-Kutz Elevator and Dissector

Catalog #	Description
400-290	7½" (193mm), double-ended, 2mm and 3mm wide round blades

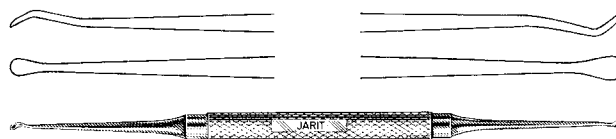

### Kleinert-Kutz Elevator and Dissector

Catalog #	Description
400-292	7" (178mm), double-ended, 2.5mm wide long blade and 4.2mm wide round blades

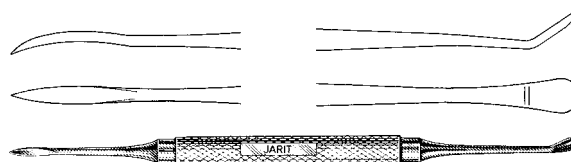

**Gillies Bone and Zygoma Hook**

Catalog #	Description
400-293	7" (178mm), 9mm hook

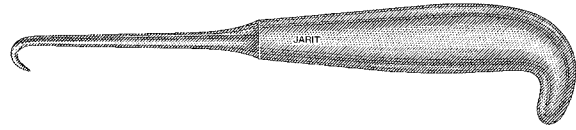

**Gillies Zygoma Elevator**

Catalog #	Description
400-294	8¾" (225mm), 9mm wide blade

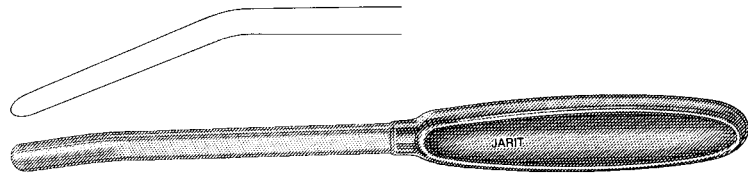

**Dunning Elevator and Curette**

Catalog #	Description
400-296	8" (201mm), double-ended, 3mm wide blade and 4mm x 6mm curette



**Gorney Septum Suction Elevator**

Catalog #	Description
400-297	7½" (190mm), 3.2mm wide tip
400-OBT-297	Replacement Obturator

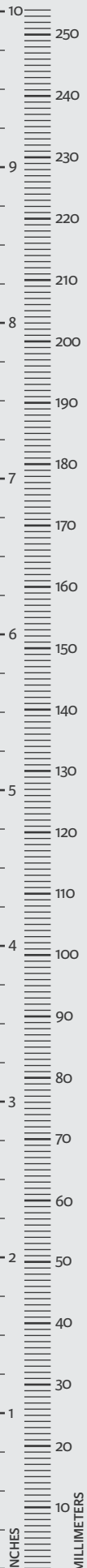

**Faulkner Antrum Curette**

Catalog #	Description
400-298	8¾" (220mm), double-ended, 7mm x 9.8mm rings, with cutting edges on both sides

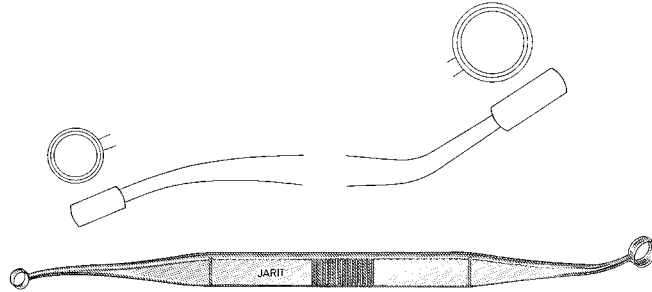

**Pratt Ethmoid Curette**

Catalog #	Description
400-299	9¼" (235mm), double-ended, 5mm solid cup straight shaft, 5mm fenestrated cup angled shaft



**Coakley Antrum Currettes**

8" (230mm), single-ended

Catalog #	Description
400-300	Set of 6
400-301	No. 1: 30° angle, 7.5mm x 9.5mm oval tip
400-302	No. 2: 60° angle, 7.5mm x 9.5mm oval tip
400-303	No. 3: 100° angle, 7.5mm x 9.5mm oval tip
400-304	No. 4: 30° angle, 6.5mm x 7.5mm oval tip
400-305	No. 5: 60° angle, 6.5mm x 7.5mm oval tip
400-306	No. 6: 30° angle, 7.5mm x 7.5mm triangular tip

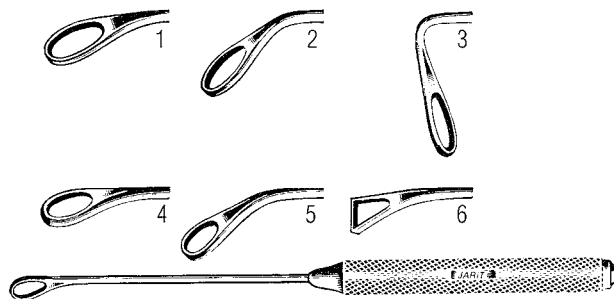

**Coakley Sinus Currettes**

7½" (190mm), 7mm x 10mm tip

Catalog #	Description
400-307	Backward cutting
400-308	Forward cutting

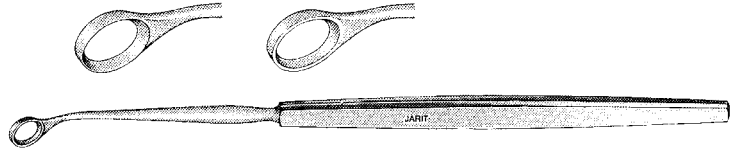

**Coakley Sinus Currettes**

9½" (241mm), double-ended

Catalog #	Description
400-320	One slightly angled oval tip and one 45° angled oval tip, 5.8mm x 6.9mm
400-321	One slightly angled oval tip and one 45° angled oval tip, 7.7mm x 9.7mm
400-322	One 90° angled oval tip and one slightly angled triangular tip, 7.7mm x 9.7mm

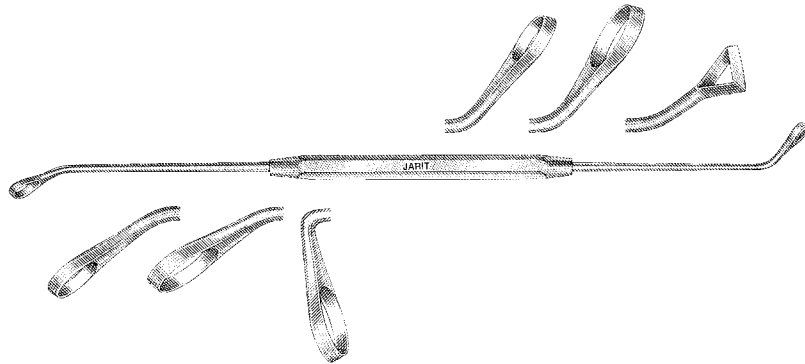

**Knight Polypus and Turbinate Forceps**

2 1/4" (56mm) working length, 7" (175mm) overall length

Catalog #	Description
405-100	5mm x 14mm cup jaws

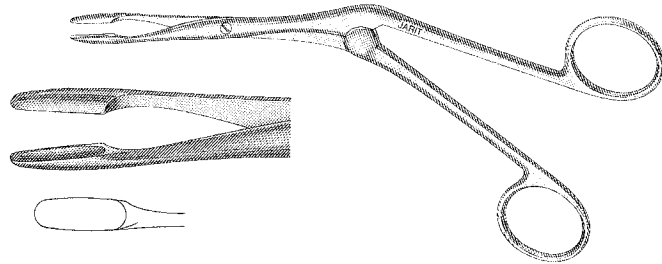

**Watson-Williams Polypus Forceps**

4 1/2" (115mm) working length, 7 1/8" (180mm) overall length

Catalog #	Description
405-105	No. 1: 6.5mm x 10mm cup jaws
405-106	No. 2: 9.5mm x 13mm cup jaws

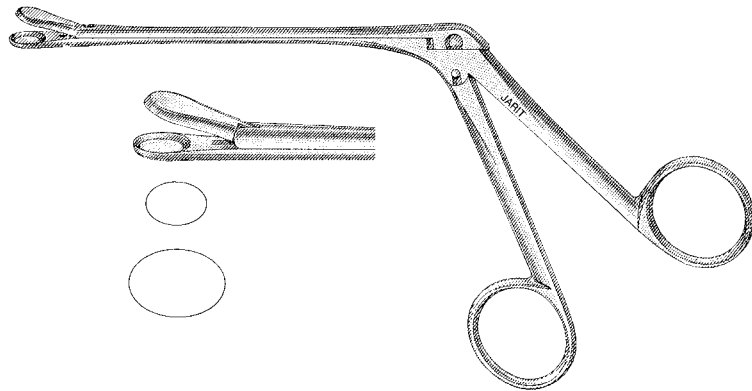

**Knight Polypus and Turbinate Forceps**

4 3/8" (112mm) working length, 7 1/2" (190mm) overall length

Catalog #	Description
405-108	5.4mm x 17mm cup jaws

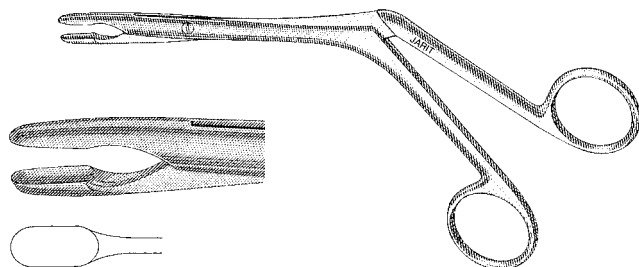

**Gruenwald Nasal Forceps**

4 1/2" (115mm) working length, 7 1/2" (190mm) overall length, thru-cutting jaws

Catalog #	Description
405-110	No. 1: 3mm x 10mm cup jaws
405-111	No. 2: 3.5mm x 11.3mm cup jaws
405-112	No. 3: 4mm x 12mm cup jaws

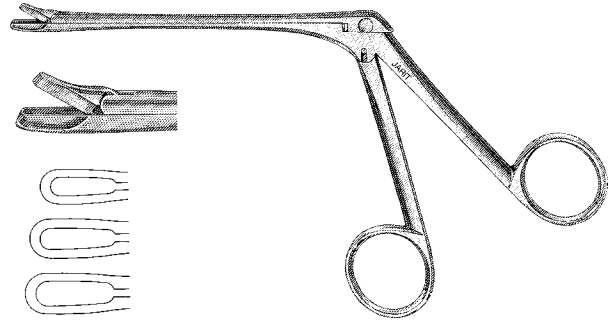

**Wilde Nasal Forceps**

5 1/2" (140mm) working length, 7 1/2" (190mm) overall length, straight, fenestrated

Catalog #	Description
280-450	No. 1: 4mm x 11mm cup jaws
280-451	No. 2: 5mm x 12mm cup jaws
280-452	No. 3: 6mm x 13mm cup jaws

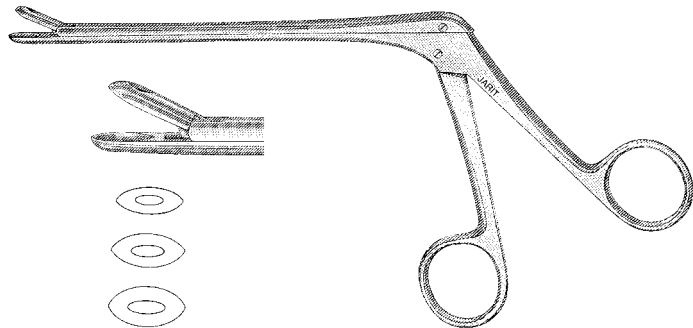

**Wilde Nasal Forceps**

4 1/2" (115mm) working length, 6 7/8" (175mm) overall length

Catalog #	Description
280-454	5mm x 10mm cup jaws

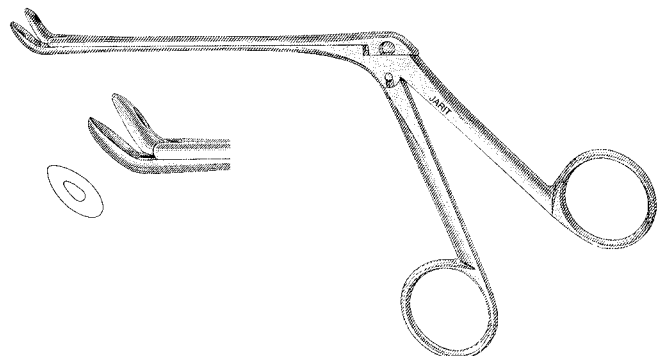



**Weil Nasal Forceps**

4 1/2" (115mm) working length, 7 1/2" (190mm) overall length,  
5mm x 8.5mm cup jaws

Catalog #	Description
405-115	Straight
405-116	Up-angled

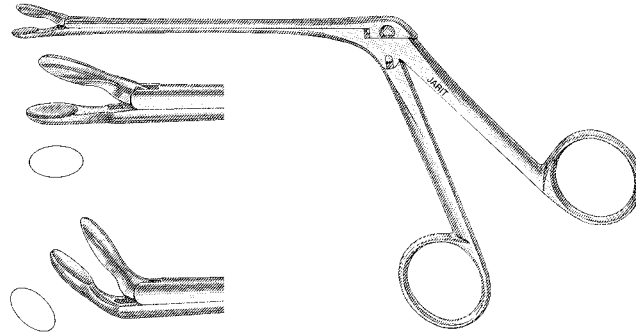

**Struempel-Voss Nasal Forceps**

4 1/4" (115mm) working length, 7 1/2" (190mm) overall length

Catalog #	Description
405-118	3mm x 5mm cup jaws

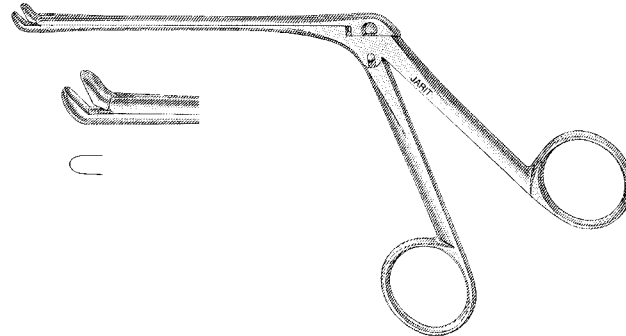

**Blakesley Septum Forceps**

4 1/2" (115mm) working length, 7 1/2" (190mm) overall length)

Catalog #	Description
405-120	6.6mm x 12mm serrated jaws

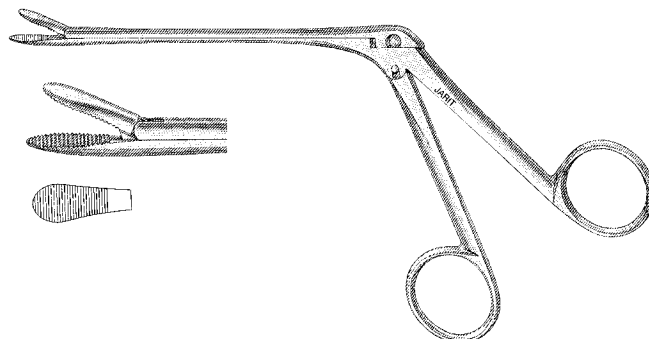

**Lewis Septum Forceps**

4 1/4" (110mm) working length, 7 1/2" (190mm) overall length

Catalog #	Description
405-122	11.5mm round grooved jaws, left side opening

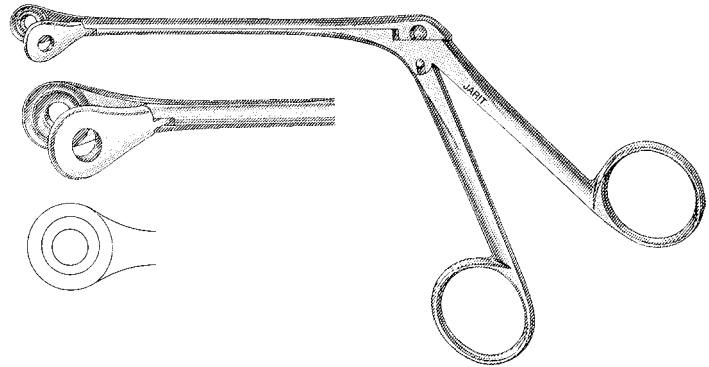

**Killian Septum Forceps**

2 5/8" (67mm) working length, 6 3/4" (170mm) overall length

Catalog #	Description
405-125	5mm x 30mm serrated jaws

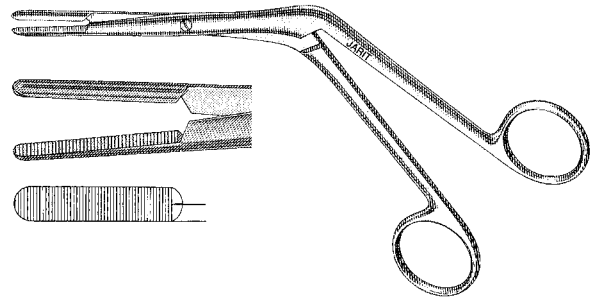

**Bruening Septum Forceps**

4 1/4" (108mm) working length, 7 3/8" (187mm) overall length

Catalog #	Description
405-130	No. 1: 7mm x 9mm jaws
405-131	No. 2: 9mm x 11mm jaws

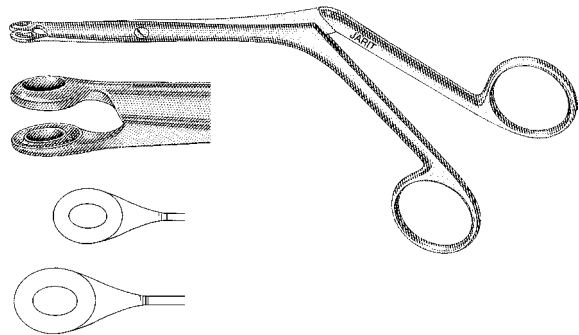

**Jansen-Middleton Septum Forceps**

7¾" (197mm)

Catalog #	Description
405-150	Cup jaws, 5mm x 12.5mm
405-152	Thru-cutting jaws, 3.6mm x 16mm
405-153	Thru-cutting jaws, 4.6mm x 16mm

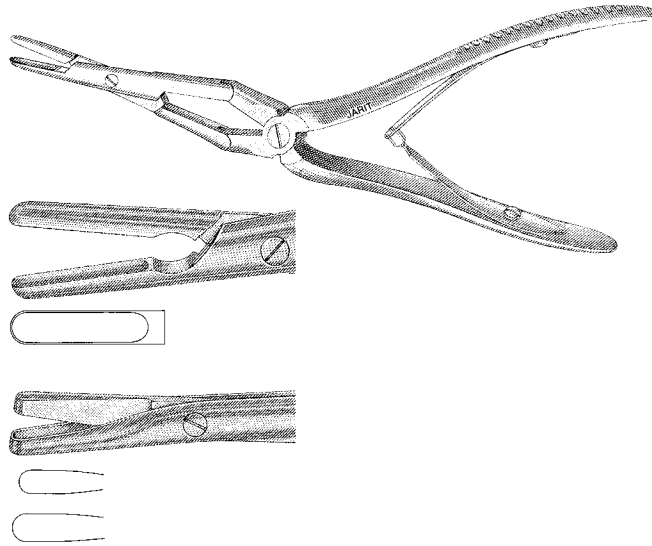

**Ferris-Smith Fragment Forceps**

4½" (115mm) working length, 7½" (190mm) overall length

Catalog #	Description
405-155	5.5mm x 9mm serrated jaws

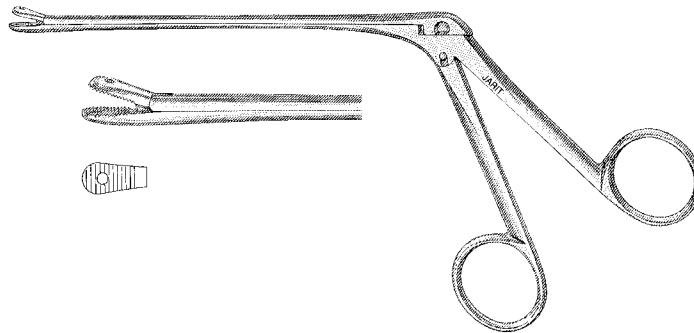

**Asch Septum Straightening Forceps**

Catalog #	Description
405-180	8¾" (225mm), angled on flat, 7mm x 44mm jaws

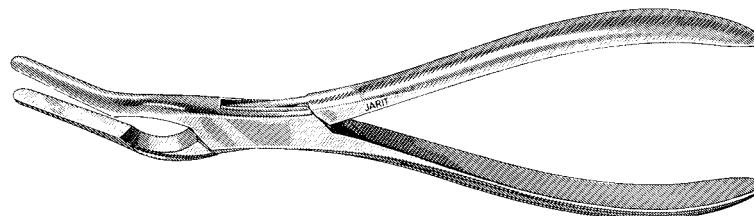

### Walsham Septum Straightening Forceps

9" (230mm)

Catalog #	Description
405-181	Straight: 7mm x 33mm jaws
405-182	Right: 7mm x 33mm jaw with flat inner surface and 9.5mm x 33mm jaw with concave inner surface
405-183	Left: 7mm x 33mm jaw with flat inner surface and 9.5mm x 33mm jaw with concave inner surface
405-184	Universal: bayonet shape, 10.5mm x 33mm jaws

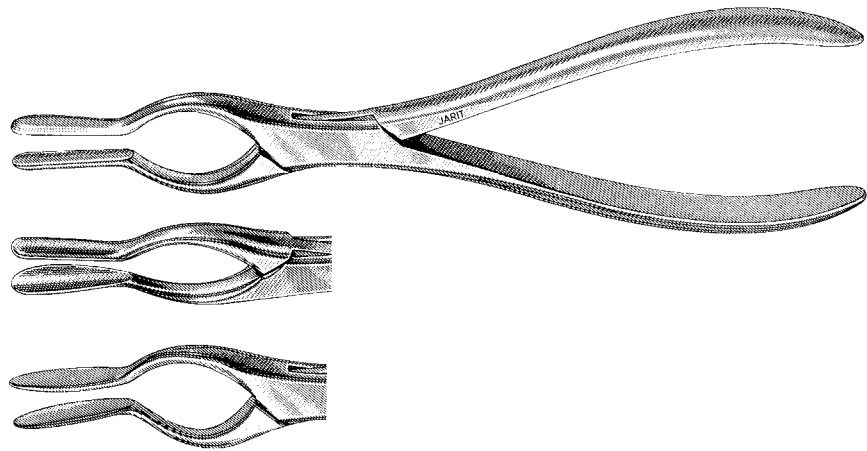

### Takahashi Nasal Forceps

4½" (115mm) working length, 7½" (190mm) overall length

Catalog #	Description
405-186	2.5mm x 10mm jaws

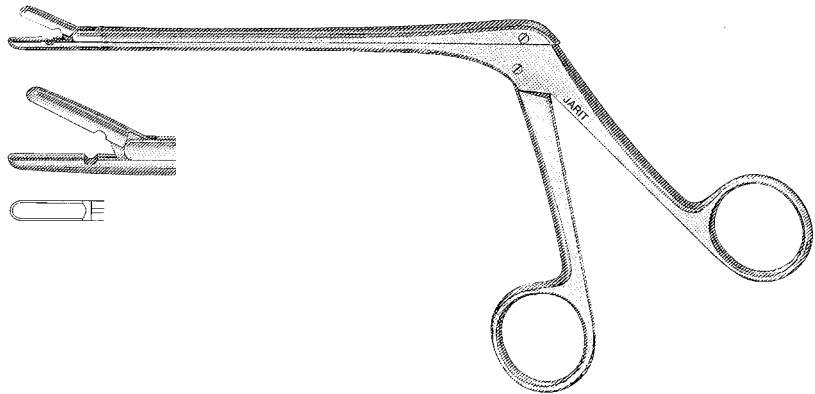

### Cottle-Kazanjian Nasal Cutting Forceps

Catalog #	Description
405-190	7½" (190mm) overall length, straight 30mm jaws

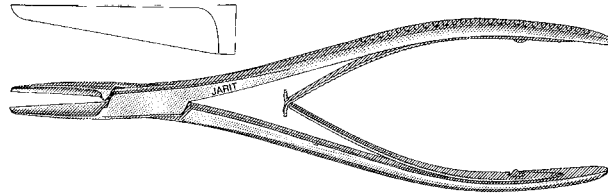

### Cottle Biting Forceps

Catalog #	Description
405-192	7" (180mm) overall length, angular 30mm jaws

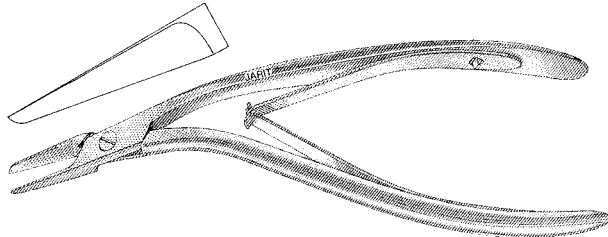

### Rowland (Ruskin-Liston) Bone Splitting Forceps

Catalog #	Description
230-310	7¼" (182mm), straight, 20mm jaws

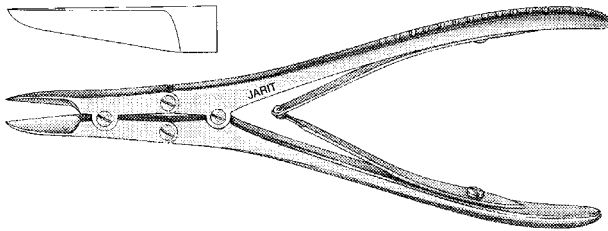

**Rubin Septum Morselizer**

Catalog #	Description
405-200	7½" (190mm), 6mm x 11mm jaws
405-201	Rubin Morselizer Guard

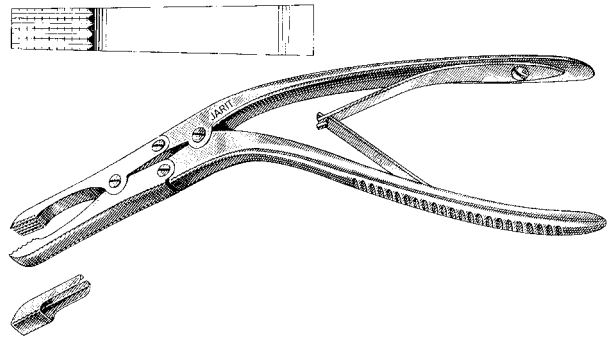

**Wright-Rubin Septum Morselizer**

Catalog #	Description
405-210	8" (205mm), 6mm x 11mm jaws

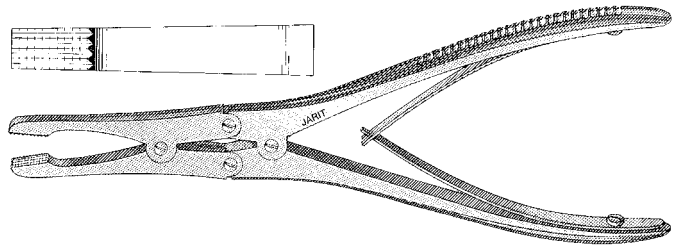

**Cottle Cartilage Crusher**

Catalog #	Description
405-225	2¾" (16mm x 70mm) crushing area

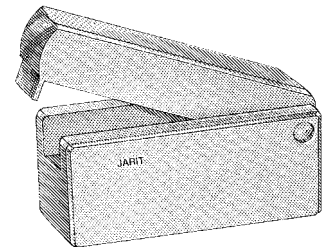

**Integra™**  
Plastic and  
Reconstructive  
Instruments and  
General Surgical  
Instruments

**Joseph Nasal Knives**

6" (152mm), double-edged, sharp

Catalog #	Description
410-100	Straight, 4mm x 23mm blade
410-101	Straight, 6mm x 23mm blade
410-105	Curved, 4mm x 23mm blade
410-106	Curved, 6mm x 23mm blade

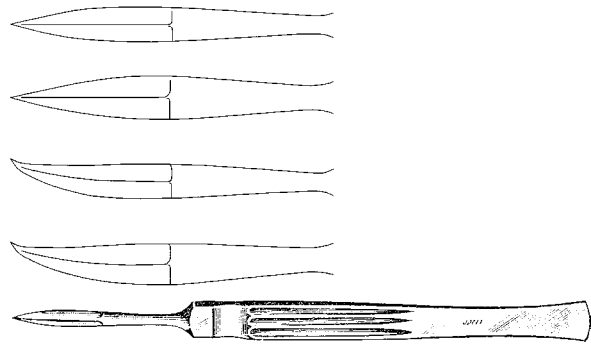

**Joseph Nasal Knives**

6" (152mm), double-edged, blunt

Catalog #	Description
410-110	Straight, 4mm x 23mm blade
410-111	Straight, 6mm x 23mm blade
410-115	Curved, 4mm x 23mm blade
410-116	Curved, 6mm x 23mm blade

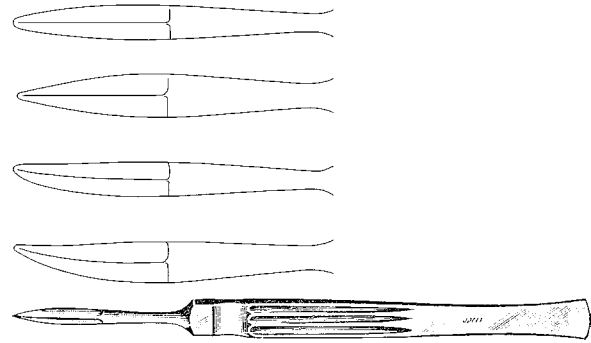

**Joseph Button End Knife**

6" (155mm)

Catalog #	Description
410-120	Straight, 29mm blade

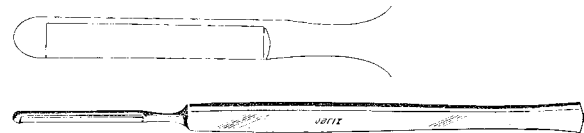

**Joseph Button End Knife**

6 3/4" (170mm)

Catalog #	Description
410-121	Angled, 9.5mm blade

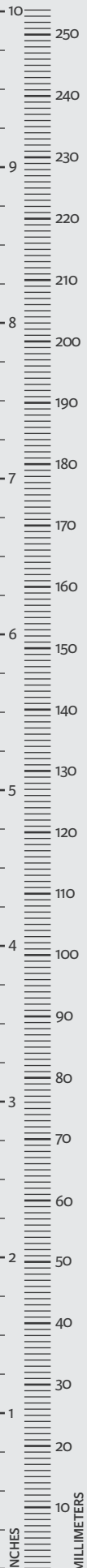
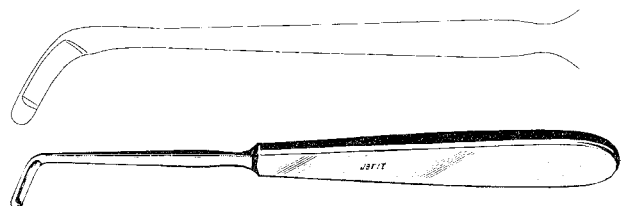



**Converse Button End Bistoury**

6 1/8" (155mm)

Catalog #	Description
410-123	Curved, 29mm blade

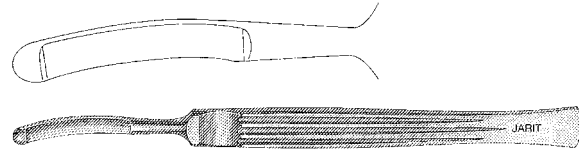

**Maltz Button End Knife**

6 3/4" (170mm)

Catalog #	Description
410-125	9mm blade

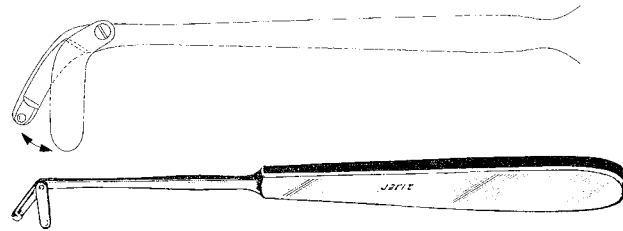

**Cottle Nasal Knife**

5 3/8" (142mm)

Catalog #	Description
410-128	4mm blade

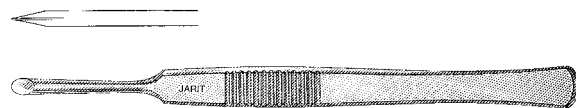

**Cottle Double Edged Knife**

6" (155mm)

Catalog #	Description
410-130	Straight, 6mm x 24mm blade

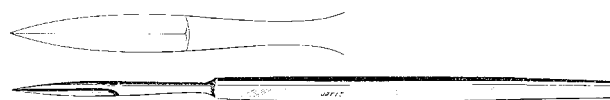

**O'Connor Hook**

Catalog #	Description
350-360	5" (127mm)

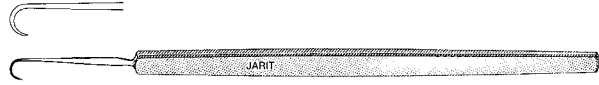

**Guthrie Hooks**

4 3/4" (121mm)

Catalog #	Description
350-370	Small: 1.5mm wide
350-371	Large: 2.5mm wide

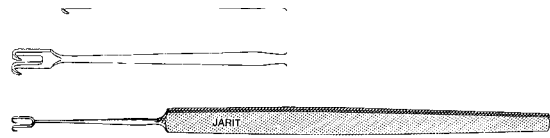

**Kleinert-Kutz Skin Hooks**

6" (152mm)

Catalog #	Description
410-135	Small: 3mm
410-136	Medium: 5mm
410-137	Large: 7mm

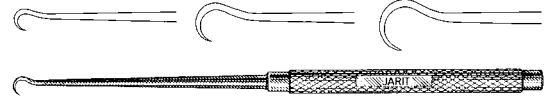

**Wiener Skin Hook**

5" (127mm)

Catalog #	Description
410-140	4.5mm fine tip

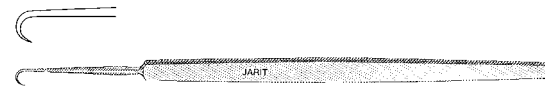

**Cottle Skin Hooks**

5 3/8" (135mm)

Catalog #	Description
410-145	Shallow curve, small, 3.6mm tip length
410-146	Deep curve, small, 2.8mm tip length
410-147	Deep curve, large, 4mm tip length

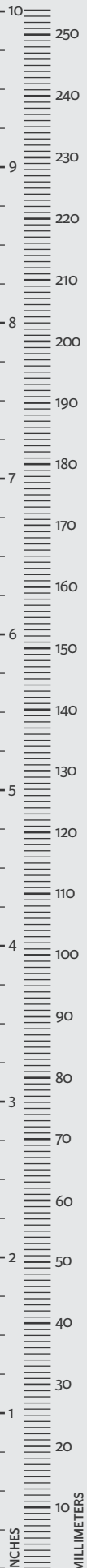
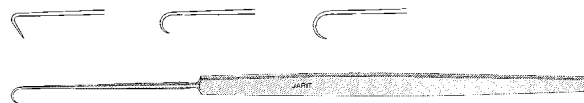

**Joseph Skin Hook**

6¼" (160mm)

Catalog #	Description
410-150	Single prong

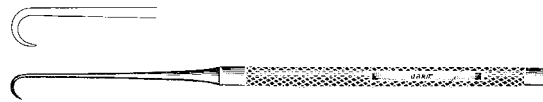

**Joseph Skin Hooks**

6¼" (159mm), double prong, widths are tip to tip

Catalog #	Description
410-151	2mm wide
410-152	5mm wide
410-153	7mm wide
410-154	10mm wide

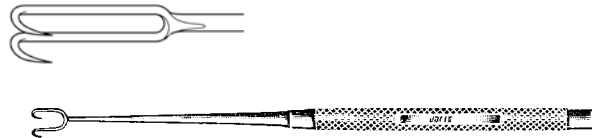

**Cottle-Joseph Double Hook**

5¾" (146mm)

Catalog #	Description
410-157	Double prong, 12mm wide

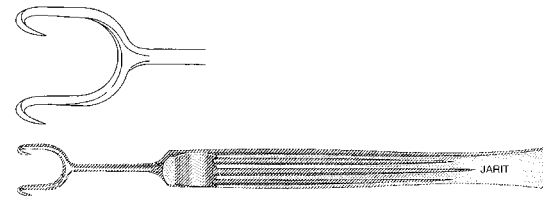

**Kilner Skin Hook**

5⅛" (130mm)

Catalog #	Description
410-160	2.4mm tip



**Kilner Skin Hook**

6" (152mm)

Catalog #	Description
410-161	2.5mm detachable hook



**Goldman Single Hook**

5⅜" (137mm)

Catalog #	Description
410-163	Right angled

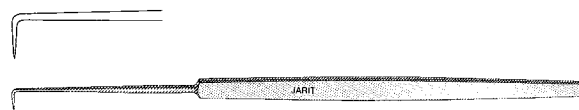

**Converse Skin Hook**

7¼" (182mm)

Catalog #	Description
410-165	Small: 2.4mm tip
410-166	Large: 4.2mm tip



**Johnson Skin Hook**

6½" (165mm)

Catalog #	Description
410-167	5mm tip

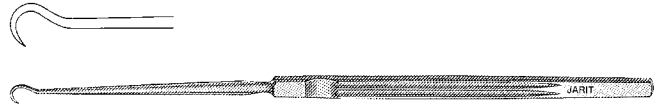

**Gilles Skin Hook**

7¼" (185mm)

Catalog #	Description
410-170	2.9mm tip



**Cottle Single Prong Tenaculum**

6½" (167mm)

Catalog #	Description
410-180	10mm tip

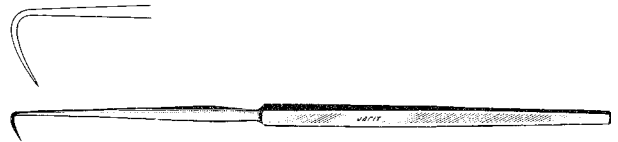

**Blair Palate Hook-Sharp**

8" (200mm)

Catalog #	Description
410-182	8.8mm tip

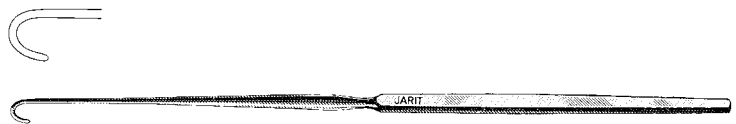

**Suraci Zygoma Hook-Elevator**

9¼" (233mm)

Catalog #	Description
410-183	21mm wide tip

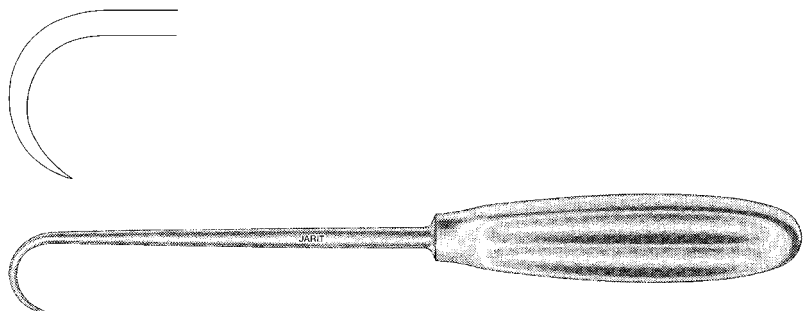

**Lahey Retractors**

4¾" (121mm), delicate

Catalog #	Description
410-185	1-prong
410-186	2-prongs
410-187	3-prongs

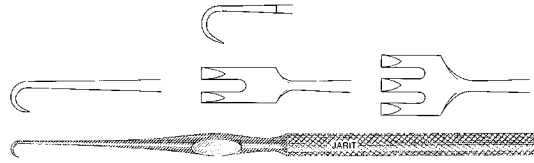

**Goldman Knife Guides and Retractors**

7" (178mm), double ended,  
3mm knife guide and 11mm retractor

Catalog #	Description
410-193	Left angled knife guide
410-194	Right angled knife guide

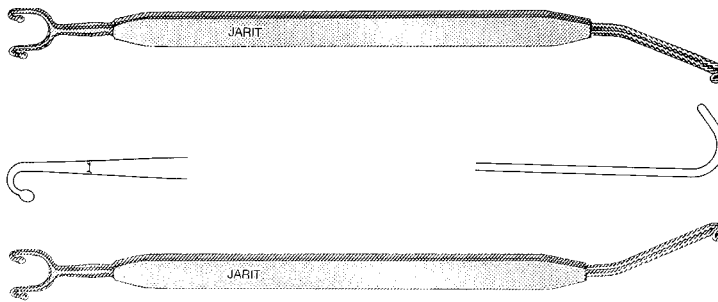

**Cottle Knife Guide and Retractor**

8" (203mm)

Catalog #	Description
410-195	Double-ended, 3mm knife guide and 13mm retractor

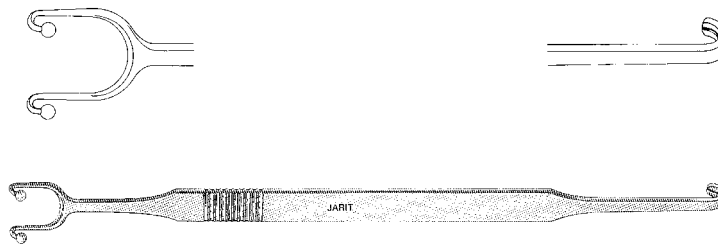

**Neivert Knife Guide and Retractor**

7¼" (196mm)

Catalog #	Description
410-196	Double-ended, 4mm knife guide and 17.5mm retractor

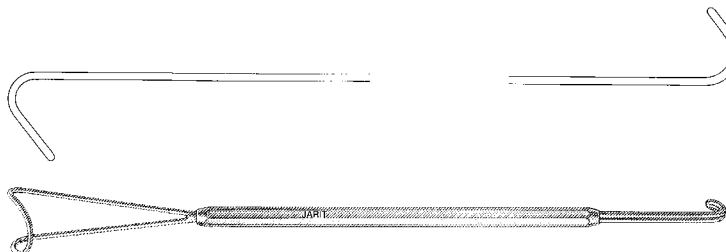

**Cottle Retractors**

5¾" (145mm), 11mm wide

Catalog #	Description
410-197	Right prong sharp
410-198	Left prong sharp

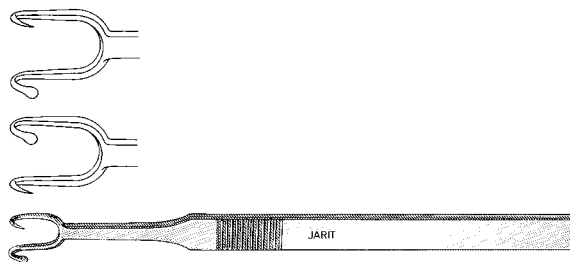

**Fomon Retractors**

6¼" (160mm)

Catalog #	Description
410-199	1-prong, ball end, 6mm deep tip
410-200	2-prong, ball ends, 10mm wide

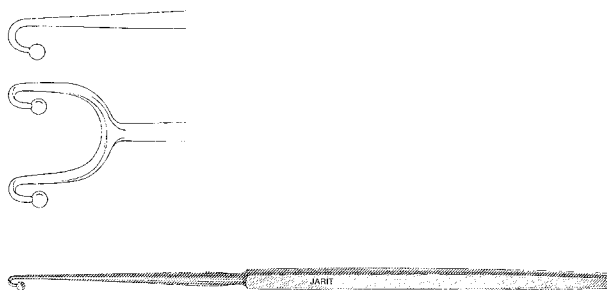

**Cottle Retractor**

5¾" (145mm)

Catalog #	Description
410-201	2-prong, sharp, 12mm wide

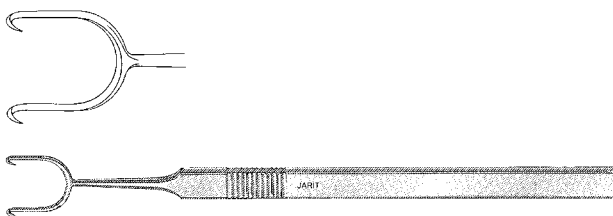

**Cottle Retractor**

6½" (166mm)

Catalog #	Description
410-202	2-prong, ball ends, 12.5mm wide

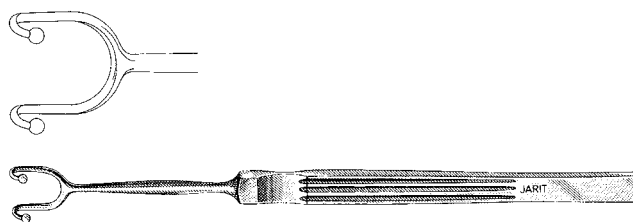

**Cottle Retractor**

5½" (140mm)

Catalog #	Description
410-203	4-prong, blunt, 8.2mm wide

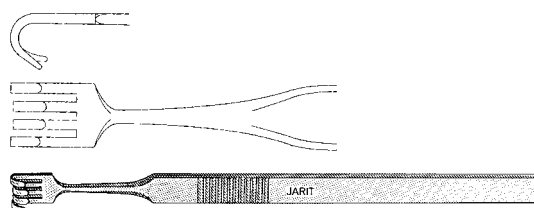

**Converse Alar Retractor**

4<sup>5</sup>/<sub>8</sub>" (117mm)

Catalog #	Description
410-205	Double-ended, 12.5 x 16mm wide

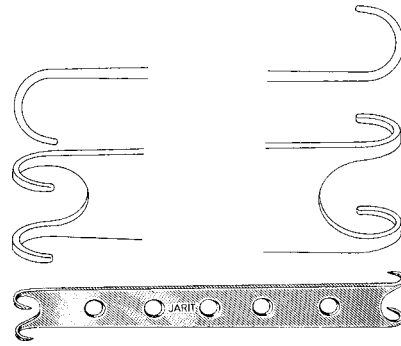

**Cottle Alar Retractor**

6<sup>1</sup>/<sub>4</sub>" (160mm)

Catalog #	Description
410-207	12mm wide

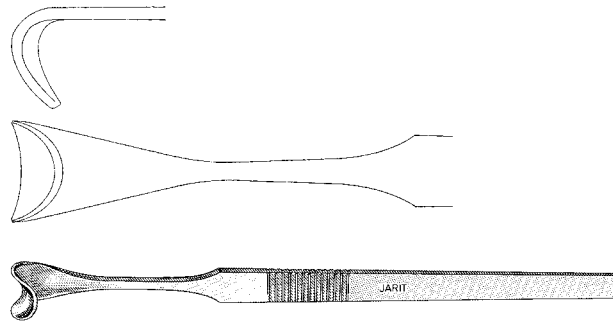

**Aufricht Nasal Retractors**

7<sup>1</sup>/<sub>4</sub>" (184mm)

Catalog #	Description
410-210	10mm x 45mm blade
410-211	11mm x 60mm blade

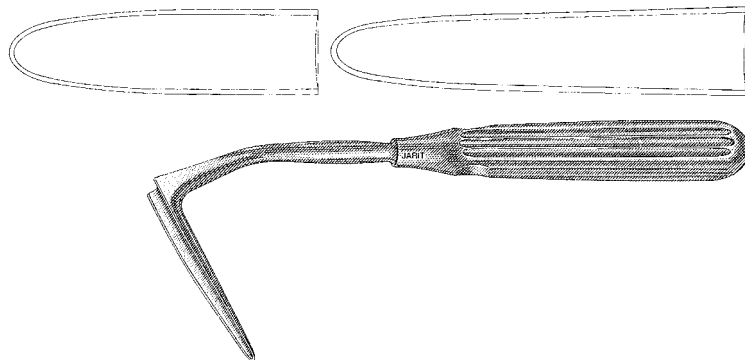

**Aufricht Nasal Retractor**

6<sup>3</sup>/<sub>4</sub>" (173mm)

Catalog #	Description
410-212	11mm x 47mm fenestrated blade

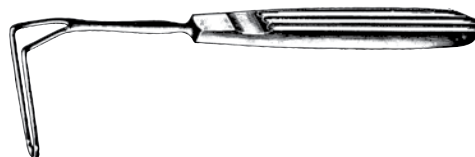

**Maliniac Nasal Retractor**

4 1/8" (104mm)

Catalog #	Description
410-215	9mm x 45mm blade

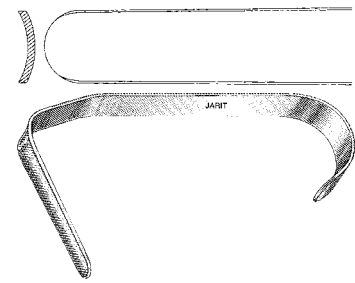

**Converse Nasal Retractor**

4 1/4" (109mm)

Catalog #	Description
410-218	11mm x 44mm blade

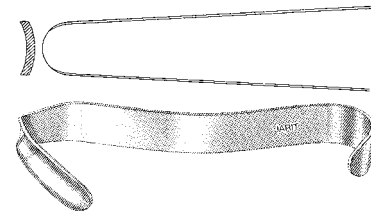

**Senn Retractors, (Satin Finish)**

6 1/4" (160mm),

double-ended, 8mm wide, solid blade 3/4" x 1/4" (19mm x 6.3mm),

Manufactured from high grade German surgical stainless steel which is ground and polished to a satin finish

Catalog #	Description
190-110	3-prong, sharp
190-112	3-prong, blunt

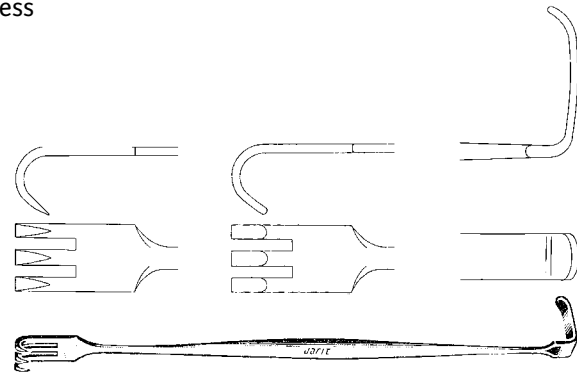

**Senn Retractors, (Matte Finish)**

6 1/4" (160mm),

double-ended, 8mm wide, solid blade 3/4" x 1/4" (19mm x 6.3mm),

Manufactured from high grade German surgical stainless steel which is glass beaded to a matte finish

Catalog #	Description
189-110	3-prong, sharp
189-112	3-prong, blunt

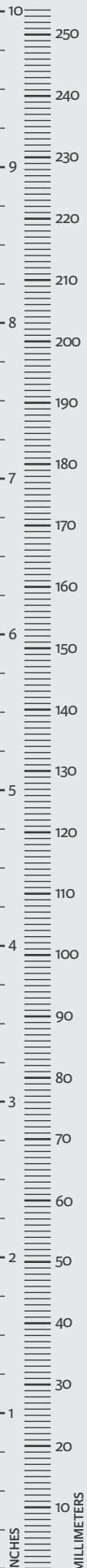
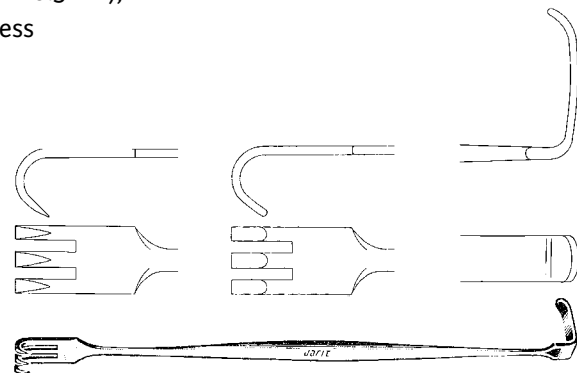



**Mathieu Retractors**

6¼" (160mm), double-ended, 8mm wide,  
solid blade ¾" x ¼" (19mm x 6.3mm)

Catalog #	Description
190-115	6¼" (160mm), 3-prong, sharp
190-116	6¼" (160mm), 3-prong, blunt

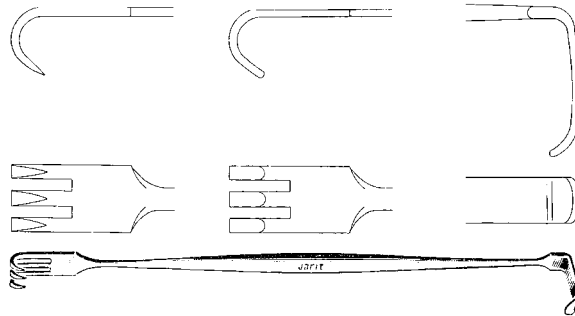

**Rollet Retractor**

5¼" (132mm)

Catalog #	Description
190-118	4 sharp prongs, 6mm blade

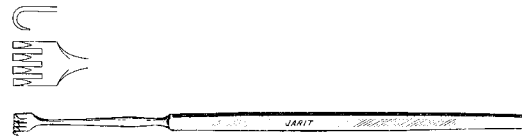

**Knapp Retractor**

5¼" (132mm)

Catalog #	Description
190-120	4 blunt prongs, 6mm blade

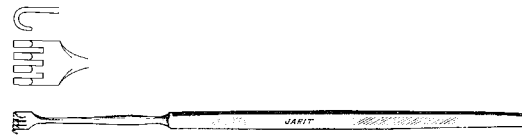

**Meyerding Skin Hook and Retractor**

6" (155mm)

Catalog #	Description
190-129	Solid blade, ⅝" x ⅜" wide (16mm x 5mm)

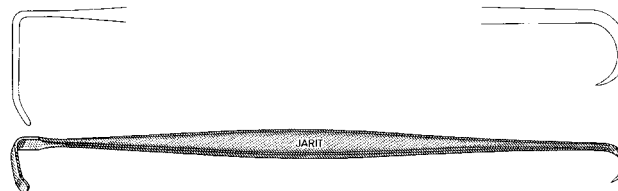

### Meyerding Finger Retractors

7" (175mm)

Catalog #	Description
190-130	Style 1, $1\frac{3}{16}$ " x $\frac{9}{32}$ " wide (21mm x 7.1mm)
190-131	Style 2, $\frac{5}{8}$ " x $\frac{3}{16}$ " wide (16mm x 5mm)
190-132	Style 3, $\frac{1}{4}$ " x $\frac{5}{32}$ " wide (6.3mm x 4mm)
190-133	Style 4, $\frac{3}{8}$ " x $\frac{1}{8}$ " wide (10mm x 3.2mm)
190-134	Style 5, $\frac{5}{16}$ " x $\frac{5}{32}$ " wide (8mm x 4mm)
190-135	Style 6, $\frac{1}{4}$ " x $\frac{5}{16}$ " wide (6.3mm x 8mm)

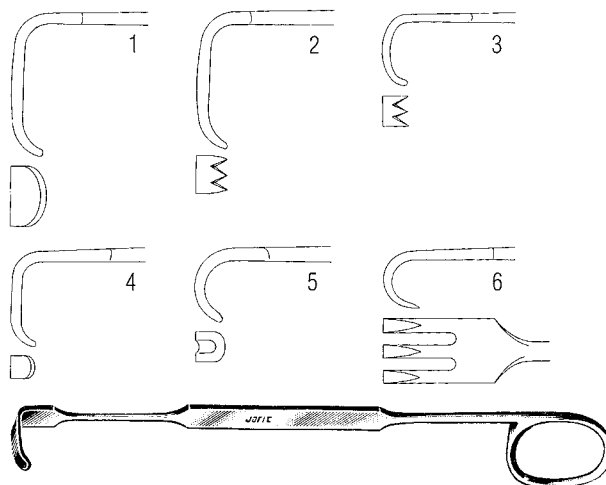

### Finger Rake Retractors

6 1/2" (165mm)

Catalog #	Description
190-150	1 prong, sharp
190-151	2 prongs, sharp, 5mm wide
190-152	3 prongs, sharp, 9mm wide
190-153	4 prongs, sharp, 12mm wide
190-154	1 prong, blunt
190-155	2 prongs, blunt, 5mm wide
190-156	3 prongs, blunt, 9mm wide
190-157	4 prongs, blunt, 12mm wide

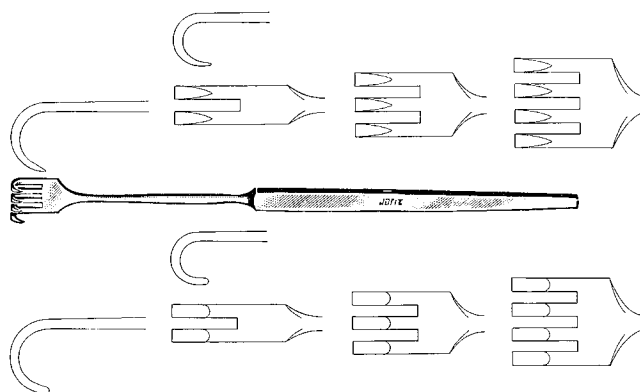

### Ragnell Retractor

5" (152mm)

Catalog #	Description
410-220	Double-ended, 2.85mm x 8.2mm and 5.6mm x 14.75mm blades

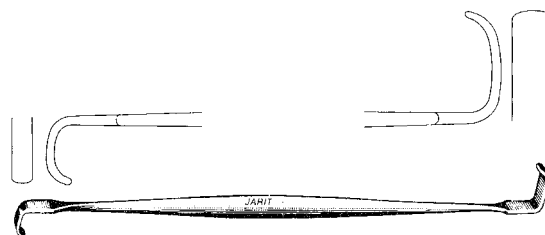

**Miller Retractors**

5¼" (133mm), 9 prongs, 16mm wide

Catalog #	Description
410-225	Blunt
410-226	Sharp

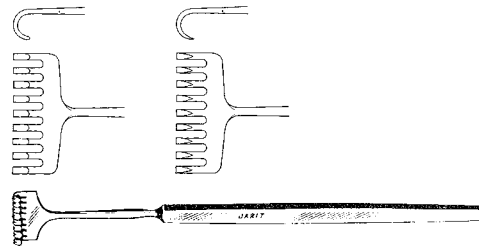

**Davis Retractor**

5¾" (145mm)

Catalog #	Description
410-230	Double-ended, Small blade ¾" x ¼" (20mm x 5.8mm) and Large blade 1" x ⅜" (25mm x 8.75mm)

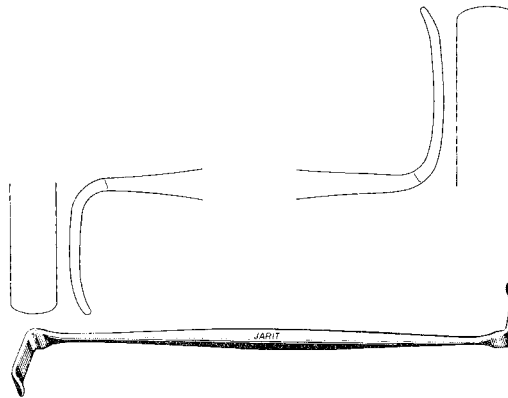

**Converse Blade Retractors**

3⅝" (93mm)

Catalog #	Description
410-235	Size 1: 9mm x 18mm blade
410-236	Size 2: 13mm x 28mm blade
410-237	Size 3: 13mm x 41mm blade
410-238	Size 4: 13mm x 55mm blade

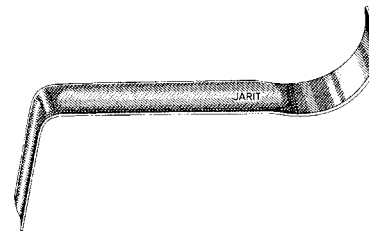

**Alm Retractor**

Catalog #	Description
205-100	2¾" (70mm), 2" (50mm) spread

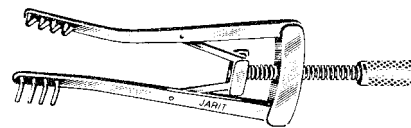

**Alm Retractor**

Catalog #	Description
205-105	3⅞" (100mm), 2½" (64mm) spread

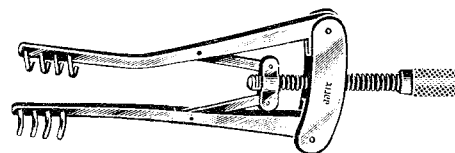

### Heiss Automatic Skin Retractors

3 7/8" (100mm), 1" (25mm) spread

Catalog #	Description
205-110	Sharp prongs
205-111	Blunt prongs

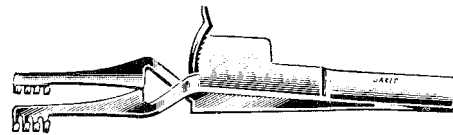

### Gelpi Perineal Retractors, (Satin Finish)

Manufactured from high grade German surgical stainless steel which is ground and polished to a satin finish

Catalog #	Description
205-123	3 7/8" (97mm)
205-124	4 5/8" (117mm)
205-125	5 1/8" (130mm)

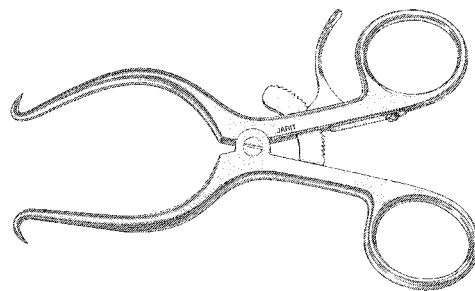

### Gelpi Perineal Retractors, (Matte Finish)

Manufactured from high grade German surgical stainless steel which is glass beaded to a matte finish

Catalog #	Description
204-123	3 3/4" (95mm)
204-124	4 3/4" (120mm)
204-125	5 1/4" (133mm)

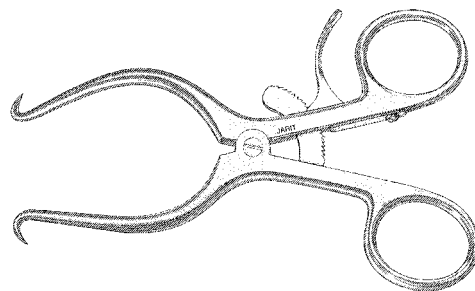

### Gelpi Perineal Retractor Parts

Catalog #	Description
205-SPS-123	Replacement Spring and Screw
205-SPS-124	Replacement Spring and Screw

### Spring Wire Retractors

Catalog #	Description
205-136	Style 1: 3" (75mm)
205-137	Style 2: 3 1/2" (90mm)
205-138	Style 3: 4 1/2" (115mm)

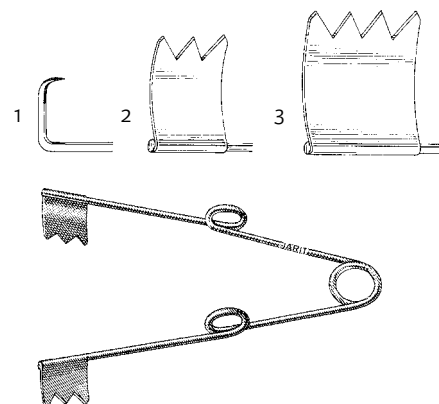

### Weitlaner Retractors, (Satin Finish)

Manufactured from high grade German surgical stainless steel which is ground and polished to a satin finish

Catalog #	Description
205-140	4 <sup>3</sup> / <sub>8</sub> " (110mm), 2 x 3 sharp prongs, 15mm deep
205-141	4 <sup>3</sup> / <sub>8</sub> " (110mm), 2 x 3 blunt prongs, 15mm deep
205-150	5 <sup>3</sup> / <sub>8</sub> " (135mm), 3 x 4 sharp prongs, 17mm deep
205-151	5 <sup>3</sup> / <sub>8</sub> " (135mm), 3 x 4 blunt prongs, 17mm deep
205-155	6 <sup>1</sup> / <sub>2</sub> " (165mm), 3 x 4 sharp prongs, 18mm deep
205-156	6 <sup>1</sup> / <sub>2</sub> " (165mm), 3 x 4 blunt prongs, 18mm deep

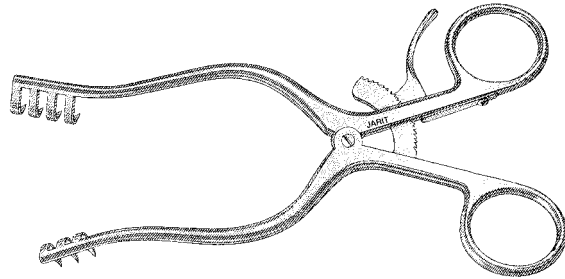

### Weitlaner Retractors, (Matte Finish)

Manufactured from high grade German surgical stainless steel which is glass beaded to a matte finish

Catalog #	Description
204-140	4 <sup>3</sup> / <sub>8</sub> " (110mm), 2 x 3 sharp prongs, 15mm deep
204-141	4 <sup>3</sup> / <sub>8</sub> " (110mm), 2 x 3 blunt prongs, 15mm deep
204-150	5 <sup>3</sup> / <sub>8</sub> " (135mm), 3 x 4 sharp prongs, 17mm deep
204-151	5 <sup>3</sup> / <sub>8</sub> " (135mm), 3 x 4 blunt prongs, 17mm deep
204-155	6 <sup>1</sup> / <sub>2</sub> " (165mm), 3 x 4 sharp prongs, 18mm deep
204-156	6 <sup>1</sup> / <sub>2</sub> " (165mm), 3 x 4 blunt prongs, 18mm deep

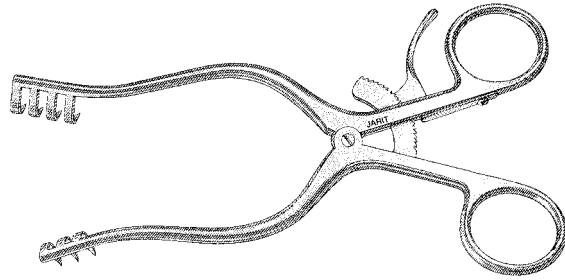

### Weitlaner Retractor Replacement Parts

Catalog #	Description
205-SPS-140	Replacement Spring and Screw
205-SPS-141	Replacement Spring and Screw
205-SPS-150	Replacement Spring and Screw
205-SPS-151	Replacement Spring and Screw
205-SPS-155	Replacement Spring and Screw
205-SPS-156	Replacement Spring and Screw
205-SPS-160	Replacement Spring and Screw
205-SPS-161	Replacement Spring and Screw

### Weitlaner Retractors

hinged blades

Catalog #	Description
205-175	5 <sup>1</sup> / <sub>2</sub> " (140mm), 3 x 4 sharp prongs, 18mm deep
205-176	5 <sup>1</sup> / <sub>2</sub> " (140mm), 3 x 4 blunt prongs, 18mm deep
205-180	6 <sup>1</sup> / <sub>2</sub> " (162mm), 3 x 4 sharp prongs, 18mm deep
205-181	6 <sup>1</sup> / <sub>2</sub> " (162mm), 3 x 4 blunt prongs, 18mm deep

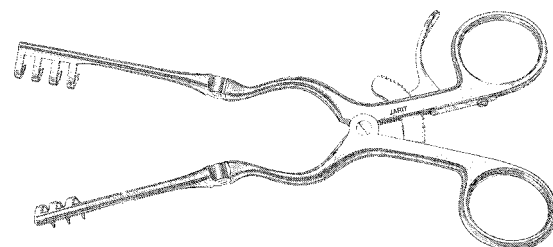

### Deschamps Ligature Carriers

Catalog #	Description
125-150	8" (203mm), sharp, left
125-152	8" (203mm), sharp, right
125-154	8" (203mm), blunt, left
125-155	8" (203mm), blunt, right

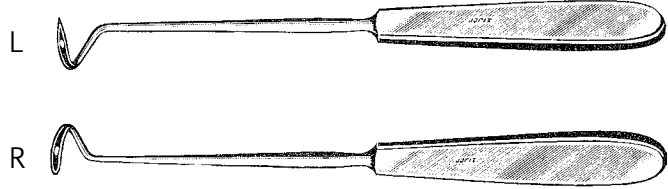

### Dingman Wire Passer

Catalog #	Description
410 -265	6¾" (170mm), curved, 2.5mm OD



### Dingman Mouth Gag

Catalog #	Description
450 -090	Complete with 3 tongue blades

### Dingman Tongue Blades

Catalog #	Description
450-091	Small blade: 25mm wide x 62mm deep x 136mm long
450-092	Medium blade: 29mm wide x 65mm deep x 136mm long
450-093	Large blade: 32mm wide x 75mm deep x 136mm long
450-FRM-090	Replacement Frame (70mm x 144mm)
450-WSR-090	Replacement Washer for Side Blade
450-BLD-090	Replacement Side Blade
450-SBA-090	Replacement Side Blade Attachment
450-SRW-090	Replacement Screws Pkg/8ea

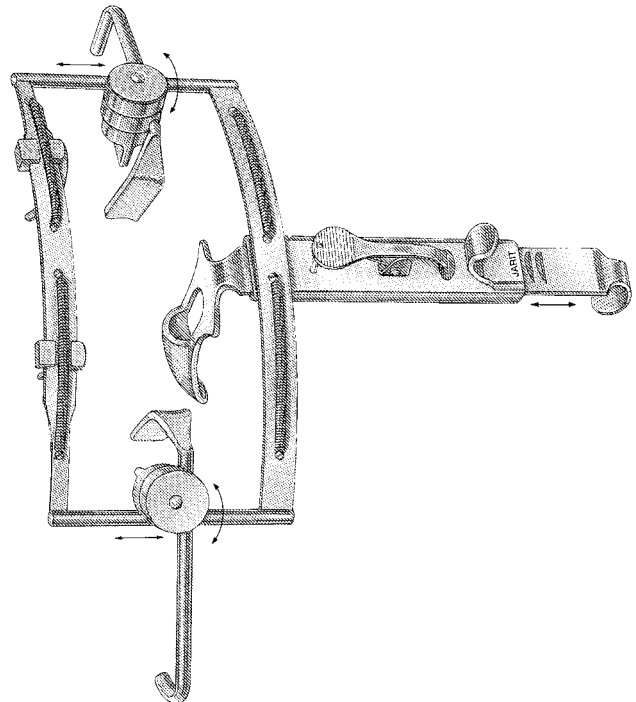

**Anderson-Neivert Osteotomes**

with guard, 8" (205mm), 4mm wide

Catalog #	Description
410-275	Curved left
410-276	Curved right

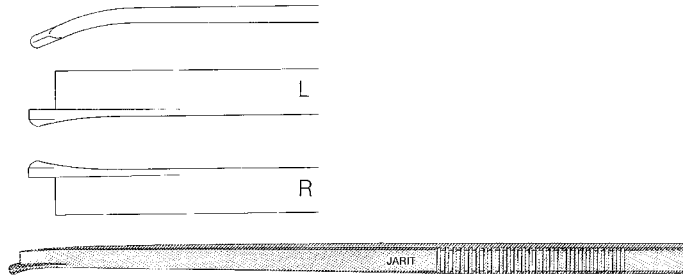

**Converse Osteotomes**

7" (180mm)

Catalog #	Description
410-280	2mm wide
410-281	4mm wide
410-282	6mm wide
410-283	8mm wide
410-284	10mm wide
410-286	12mm wide
410-288	14mm wide

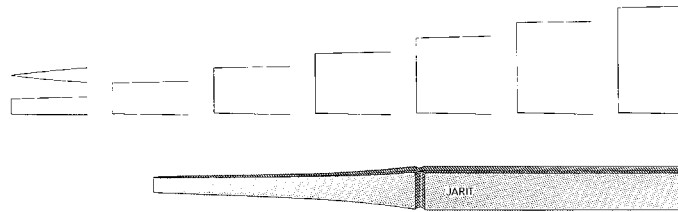

**Cottle Chisels**

7¼" (184mm), depth marking at 20mm, 30mm, 40mm and 50mm

Catalog #	Description
410-290	4mm wide
410-291	7mm wide
410-292	9mm wide
410-293	12mm wide

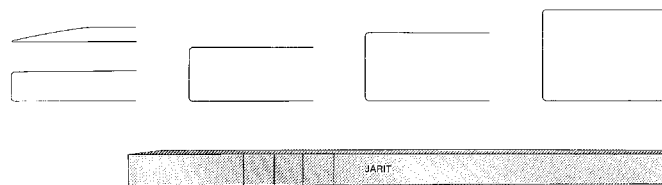

**Cottle Chisel**

7¼" (185mm)

Catalog #	Description
410-295	Curved, 6mm wide, depth markings at 36, 46, 56 and 66 millimeters

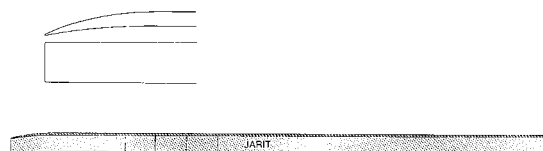

**Fomon Chisel**

with guard, 6½" (165mm), 7mm wide

Catalog #	Description
410-296	Straight

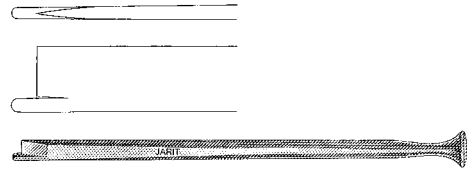

**Converse Chisels**

with guard, 7¾" (195mm), 6mm wide

Catalog #	Description
410-297	Curved right
410-298	Curved left



**Silver Osteotomes**

with guard, 6¾" (172mm), 4mm wide

Catalog #	Description
410-300	Straight
410-301	Curved right
410-302	Curved left

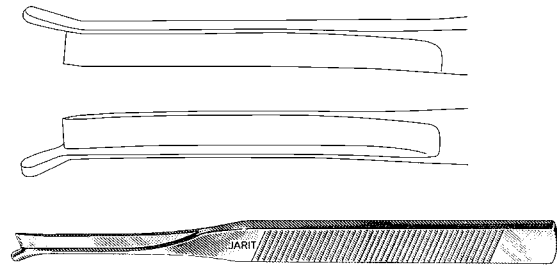

**Cinelli Osteotomes**

double-guarded, 6¼" (160mm), 4mm wide

Catalog #	Description
410-305	10mm wide, straight
410-306	12mm wide, straight
410-307	14mm wide, straight
410-308	16mm wide, straight
410-310	10mm wide, curved

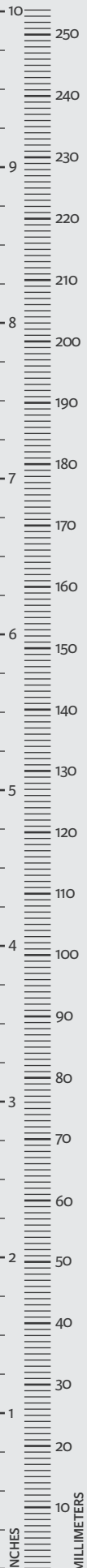
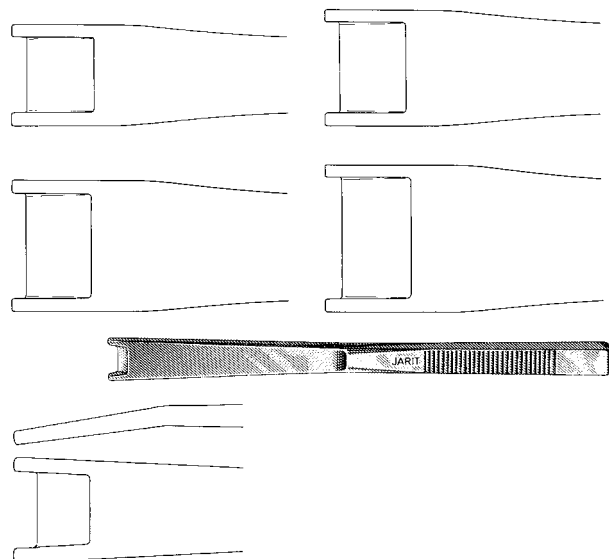



**Parkes Osteotome**

with guard, 6¼" (160mm), 4mm wide

Catalog #	Description
410-312	Straight

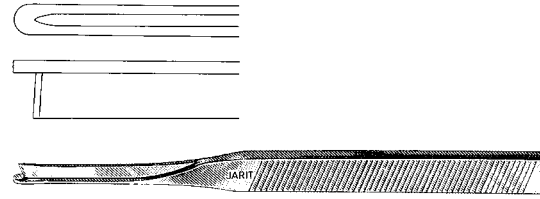

**Parkes Hump Gouge**

with guard, 7" (177mm), 6mm wide

Catalog #	Description
410-313	Double-guarded, straight

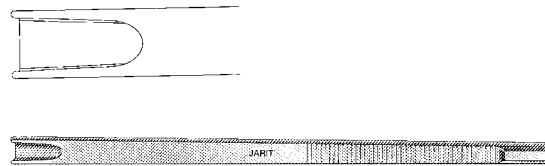

**Neivert Osteotome**

with guard, 8" (203mm), 5mm wide

Catalog #	Description
410-314	Straight



**Rubin Osteotomes**

6½" (165mm), with finger grip, rounded corners

Catalog #	Description
410-316	16mm wide
410-317	14mm wide
410-318	11mm wide

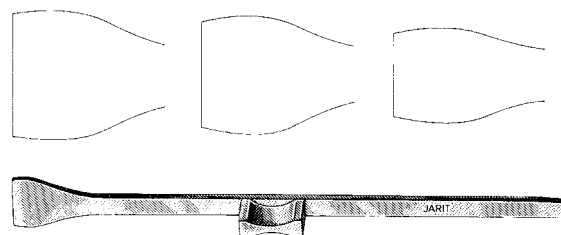

**Hexagonal Handle Osteotomes**

5 7/8" (150mm)

Catalog #	Description
410-319	2mm wide
410-320	3mm wide
410-321	4mm wide
410-322	5mm wide
410-323	6mm wide
410-324	7mm wide
410-325	8mm wide
410-326	9mm wide
410-327	10mm wide
410-328	11mm wide
410-329	12mm wide

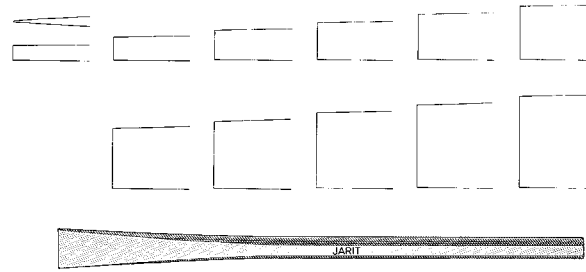

**Copper Head Mallet**

7 1/4" (182mm)

Catalog #	Description
410-330	Copper head: weight 2.5 oz., diameter 3/4" (20mm)

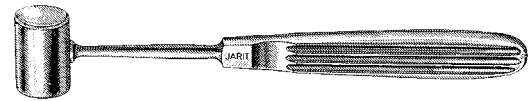

**Mallet w/Nylon Head**

7 1/4" (187mm), 2 replaceable nylon caps

Catalog #	Description
250-398	Anodized aluminum handle, head: weight 4 oz., diameter 1" (25mm)

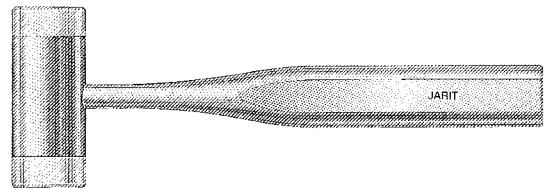

**Mallet w/Nylon Head**

7 1/4" (187mm), 1 replaceable nylon cap, 1 stainless steel facing

Catalog #	Description
250-399	Anodized aluminum handle, head: weight 5 oz., diameter 1" (25mm)

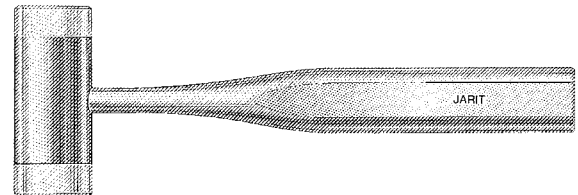

**Nylon Cap**

Catalog #	Description
250-410	For 250-398 and 250-399

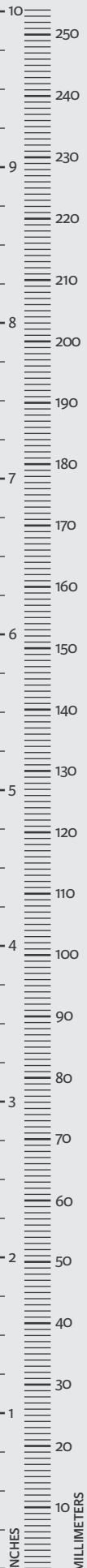

**Converse Osteotomes**

with guard, 7¾" (195mm), straight

Catalog #	Description
410-332	4mm wide
410-333	5mm wide

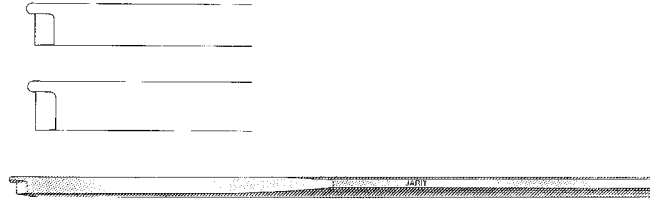

**Cottle Osteotomes**

7" (180mm), with mm depth marking, in 10mm increments up to 80mm

Catalog #	Description
410-345	4mm wide
410-346	6mm wide
410-347	8mm wide
410-348	10mm wide
410-349	12mm wide

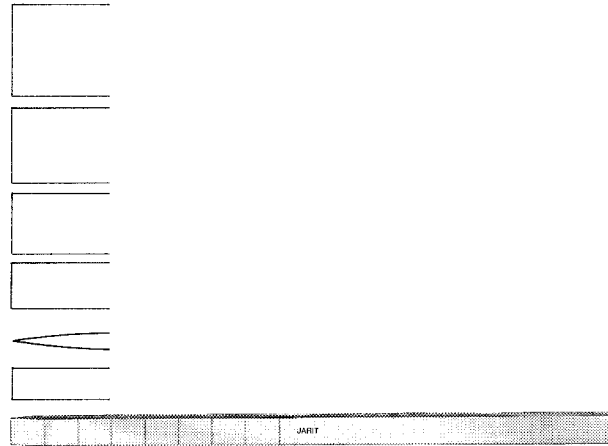

**Cottle Mallet**

7" (178mm)

Catalog #	Description
410-335	Black aluminum handle, one flat face and one round face, head: weight 7 oz., diameter 1⅞" (30mm)

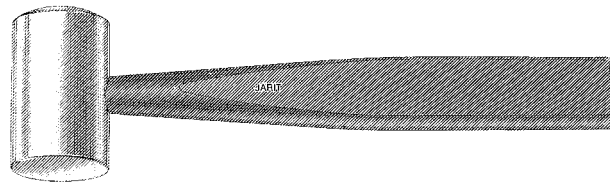

**Quisling Intra-nasal Hammer**

7" (180mm)

Catalog #	Description
410-340	7.5mm head

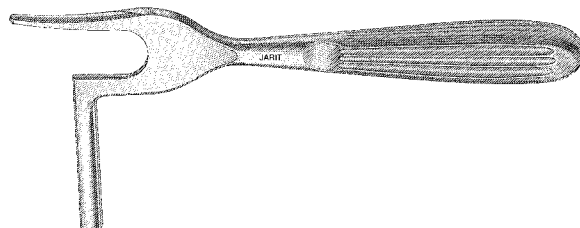

**Ragnell Undermining Scissors**

5¼" (133mm), 17mm flat tip blades

Catalog #	Description
415-100	Straight
415-101	Half curve
415-102	Full curve

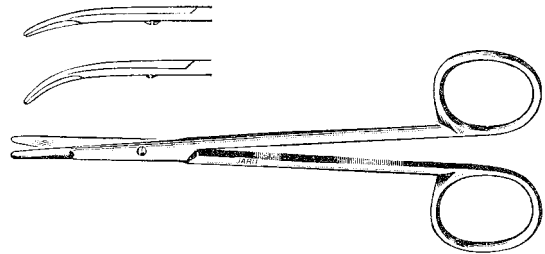

**Cinelli Lower Lateral Scissors**

4⅝" (116mm), 22mm blades

Catalog #	Description
415-105	Full curve

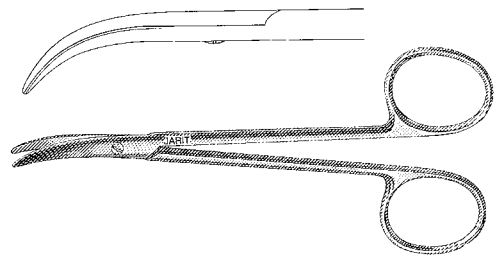

**Fomon Lower Lateral Scissors**

4½" (114mm), 24mm blades

Catalog #	Description
415-110	Full curve

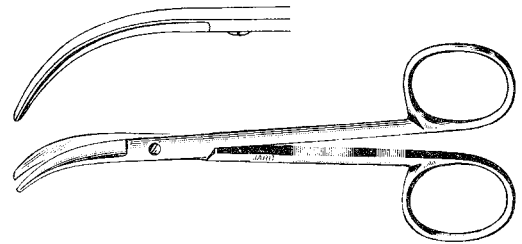

**Lower Lateral Scissors**

6½" (168mm), 19mm blades

Catalog #	Description
415-112	Full curve

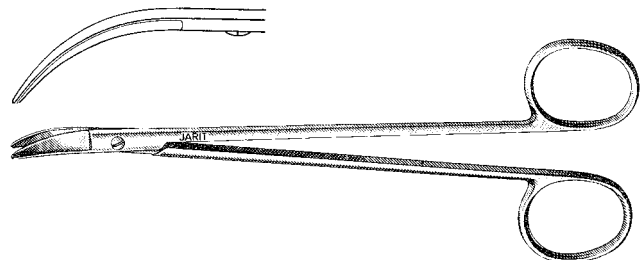

**Dorsal Scissors**

4<sup>5</sup>/<sub>8</sub>" (119mm)

Catalog #	Description
415-114	Straight, 30mm blades

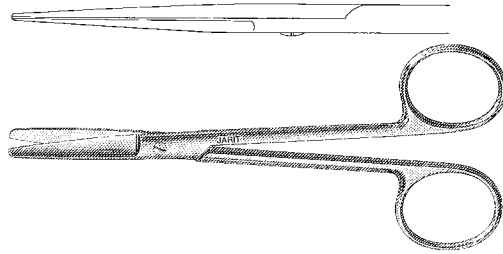

**Fomon Dorsal Scissors**

5<sup>3</sup>/<sub>4</sub>" (146mm)

Catalog #	Description
415-115	Angled handles, 35mm blades

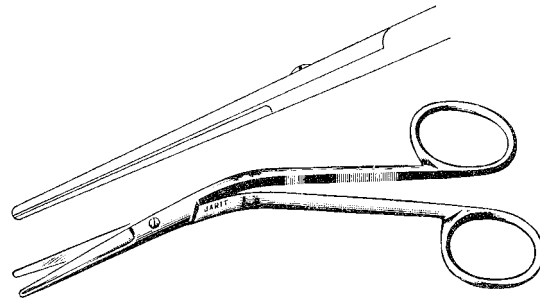

**Goldman Dorsal or Septum Scissors**

5<sup>3</sup>/<sub>4</sub>" (146mm)

Catalog #	Description
415-116	Angled handles, 40mm serrated blades

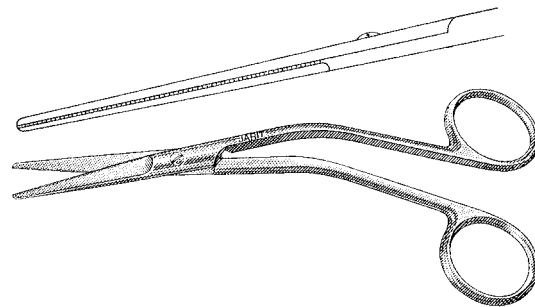

**Cottle Dorsal Scissors**

5<sup>3</sup>/<sub>4</sub>" (146mm)

Catalog #	Description
415-117	Heavy, angled handles, 55mm length blades

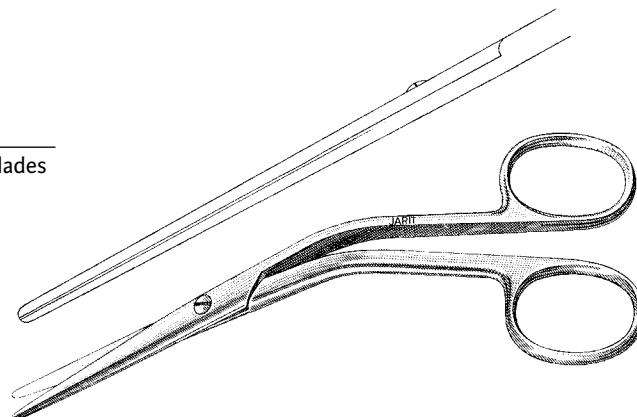

### Caplan Nasal Bone Scissors

8" (203mm)

Catalog #	Description
415-118	Double action, 22mm serrated blades

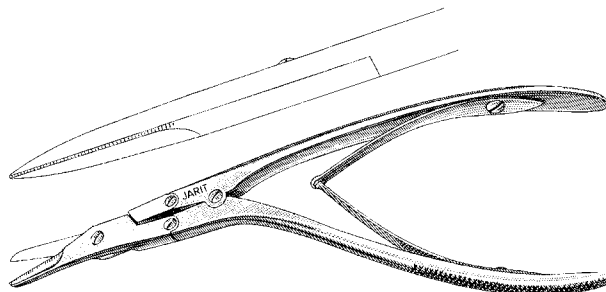

### Cottle Septum Scissors

7¼" (187mm)

Catalog #	Description
415-119	Angled handles, 44mm serrated blades

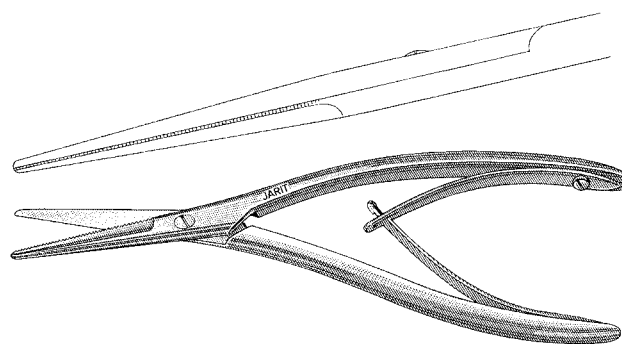

### Miller Dissecting Scissors

5" (128mm)

Catalog #	Description
415-120	32mm semi-sharp outer edge blades

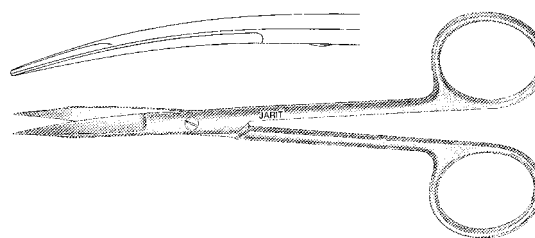

### Kaye Dissecting Scissors

4⅛" (106mm)

Catalog #	Description
415-121	Curved, 22mm serrated blades

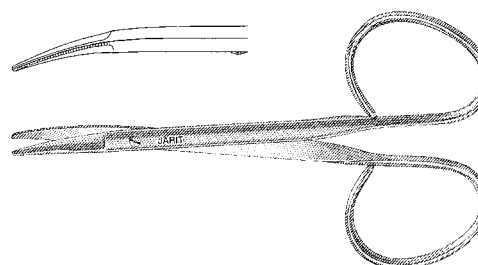

**Fomon Saber Back Scissors**

5<sup>3</sup>/<sub>8</sub>" (136mm)

Catalog #	Description
415-123	Curved, 29mm semi-sharp outer edge blades

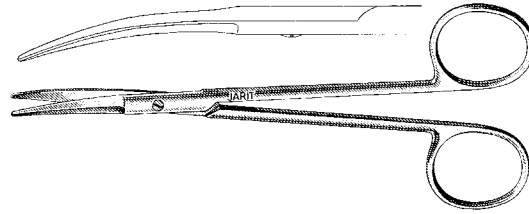

**Goldman Nasal Scissors**

5<sup>5</sup>/<sub>8</sub>" (143mm)

Catalog #	Description
415-124	Curved, 29mm semi-sharp outer edge blades

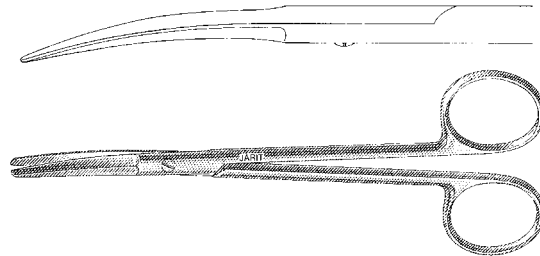

**Aufricht Nasal Scissors**

5<sup>3</sup>/<sub>4</sub>" (146mm)

Catalog #	Description
415-125	Curved, 43mm semi-sharp outer edge blades

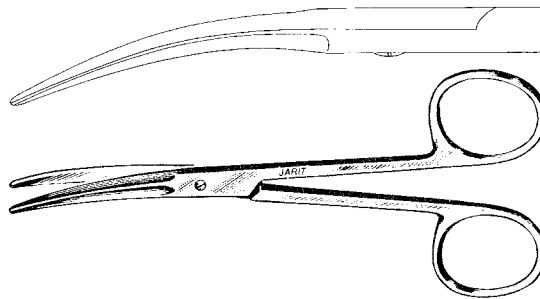

**Jackson Nasal Bone Scissors**

7<sup>3</sup>/<sub>4</sub>" (200mm)

Catalog #	Description
415-127	Angled, heavy pattern

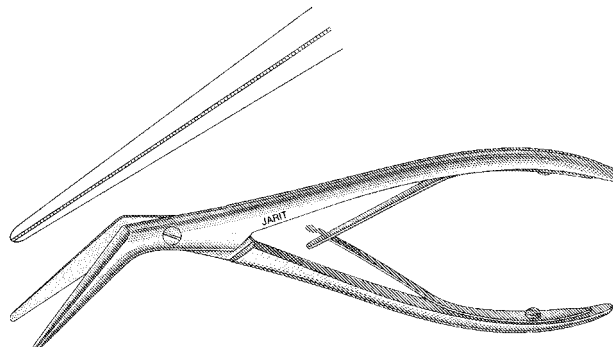

**Becker Septum Scissors**

7¼" (183mm)

Catalog #	Description
415-130	22mm serrated blades

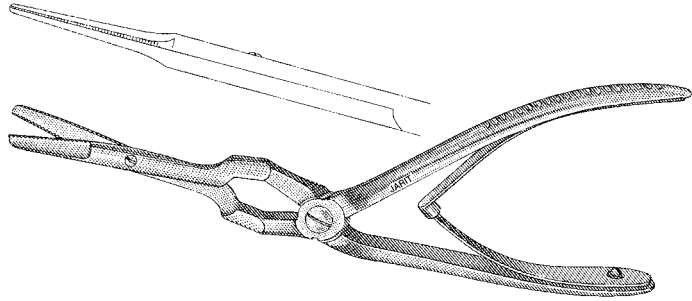

**Gorney Turbinate Scissors**

8¼" (210mm)

Catalog #	Description
415-133	Double action, 35mm serrated blades

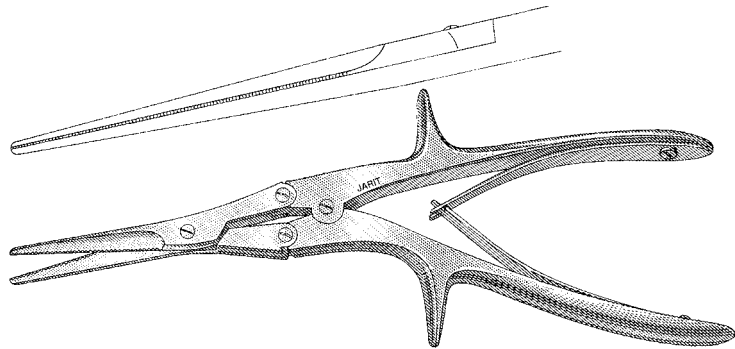

**Brophy Gum and Suture Scissors**

5¾" (146mm), 35mm sharp blades

Catalog #	Description
415-140	Straight
415-141	Curved

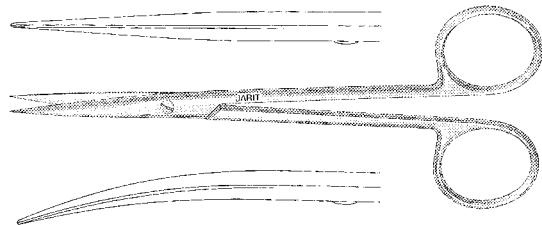

**Littler Suture Carrying Scissors**

4¾" (120mm)

Catalog #	Description
415-145	22mm curved blades

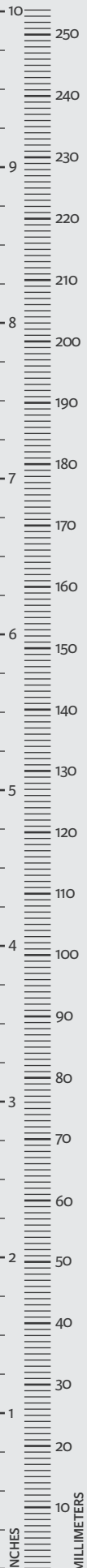
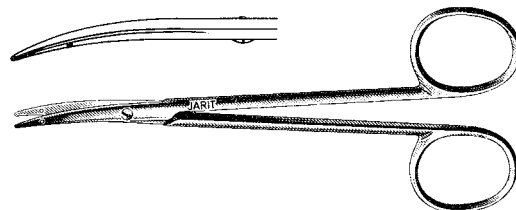



**Brown Dissecting Scissors**

5¾" (146mm), heavy handles, 42.5mm narrow blades

Catalog #	Description
415-150	Straight
415-152	Curved

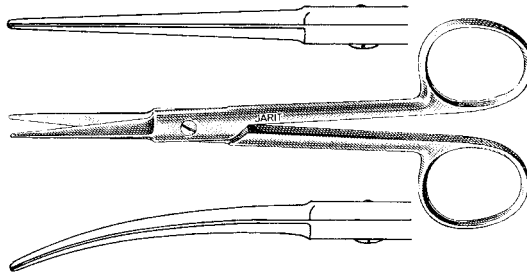

**Brown Dissecting Scissors**

5½" (139mm), 35mm length blades

Catalog #	Description
415-170	Straight
415-172	Curved

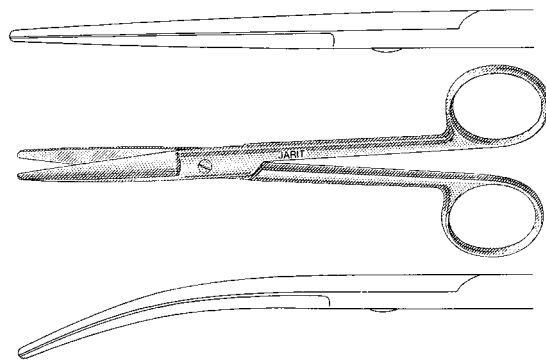

**Metzenbaum-Lahey Scissors, (Mirror Finish)**

Manufactured from high grade German surgical stainless steel which is ground and polished to a mirror finish

Catalog #	Description
100-250	5⅞" (149mm), straight
100-251	5⅞" (149mm), curved

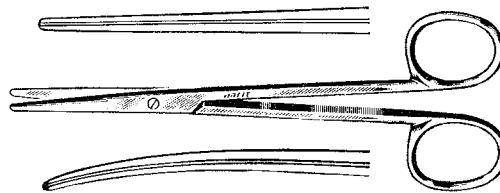

**Metzenbaum-Lahey Scissors, (Matte Finish)**

Manufactured from high grade German surgical stainless steel which is glass beaded to a matte finish

Catalog #	Description
099-250	5⅞" (149mm), straight
099-251	5⅞" (149mm), curved

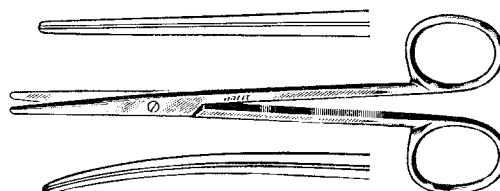

**Metzenbaum Scissors**

7" (178mm), (Mirror Finish)

Catalog #	Description
100-261	Curved, slender, delicate

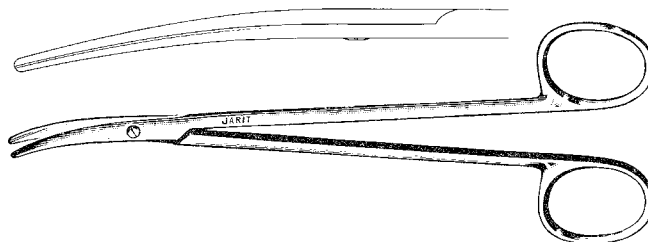

**Metzenbaum-Baby Scissors**

5 1/4" (135mm), delicate, (Mirror Finish)  
dissecting tips

Catalog #	Description
100-269	Straight
100-270	Curved

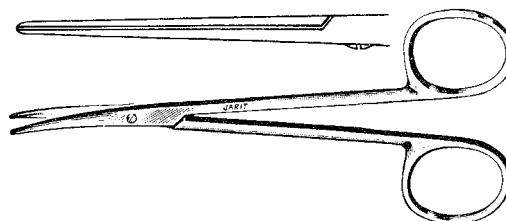

**Metzenbaum-Lahey Scissors**

5 5/8" (143mm), (Mirror Finish)

Catalog #	Description
100-272	Curved, delicate

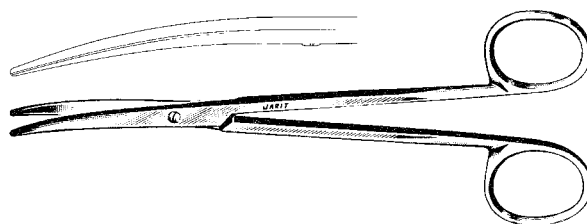

**Joseph Scissors**

5 5/8" (143mm)

Catalog #	Description
100-278	Straight
100-279	Curved

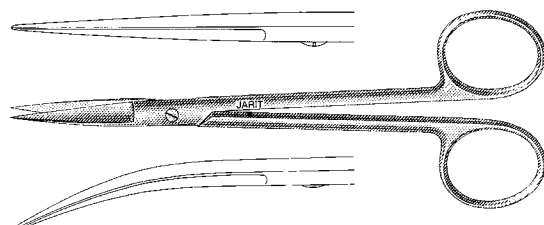

**Flat Tip Scissors**

curved

Catalog #	Description
100-290	5 3/8" (137mm)
100-291	7" (178mm)

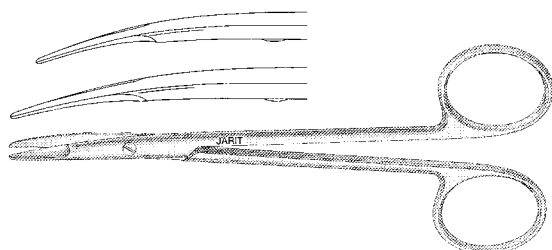

**Plastic Surgery Scissors**

4<sup>7</sup>/<sub>8</sub>" (124mm), 33mm blades, sharp-blunt

Catalog #	Description
100-320	Straight
100-322	Curved

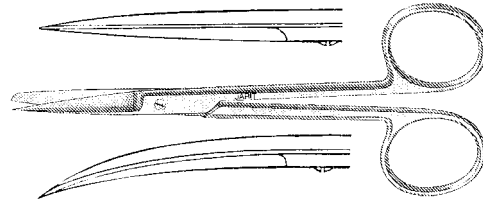

**Plastic Surgery Scissors**

4<sup>7</sup>/<sub>8</sub>" (124mm), 33mm blades, sharp-sharp

Catalog #	Description
100-325	Straight
100-327	Curved

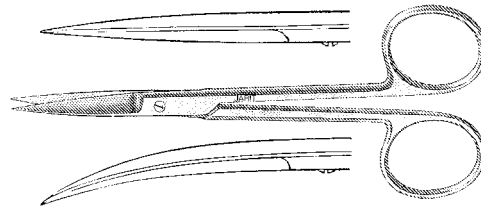

**Plastic Surgery Scissors**

4<sup>7</sup>/<sub>8</sub>" (124mm), 33mm blades, blunt-blunt

Catalog #	Description
100-330	Straight
100-332	Curved

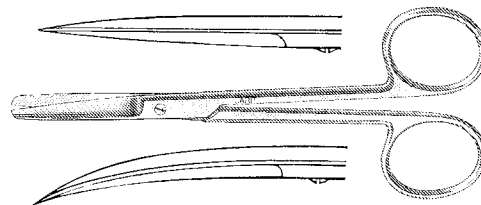

**O'Brien Suture Scissors**

3<sup>7</sup>/<sub>8</sub>" (100mm)

Catalog #	Description
125-195	Angled

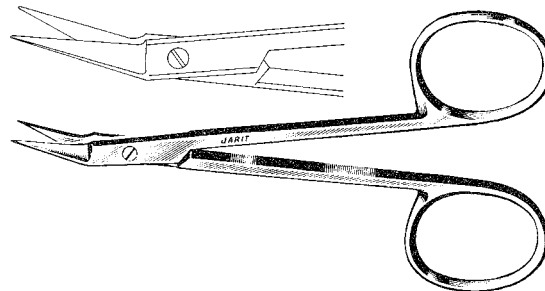

**Knapp Iris Scissors, Sharp-Sharp**

4" (103mm), 25mm blades

Catalog #	Description
360-090	Straight
360-093	Curved

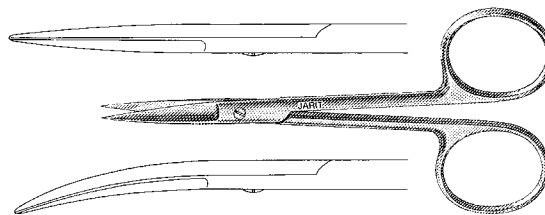

**Knapp Iris Scissors, Sharp-Blunt**

4" (103mm), 25mm blades

Catalog #	Description
360-091	Straight
360-094	Curved

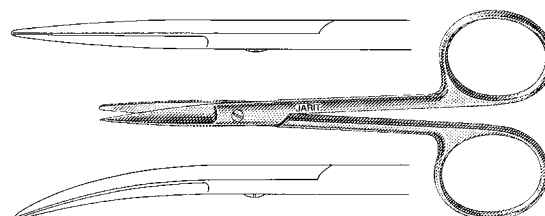

**Knapp Iris Scissors, Blunt-Blunt**

4" (103mm), 25mm blades

Catalog #	Description
360-092	Straight
360-095	Curved

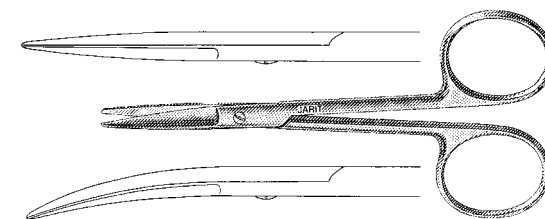

**Iris Scissors, Sharp-Sharp, (Mirror Finish)**

Manufactured from high grade German surgical stainless steel which is ground and polished to a mirror finish

Catalog #	Description
360-100	4 5/8" (116mm), 25mm blades, straight
360-101	4 5/8" (116mm), 25mm blades, curved

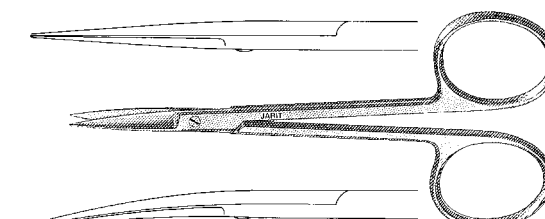

**Iris Scissors, Sharp-Sharp, (Matte Finish)**

Manufactured from high grade German surgical stainless steel which is glass beaded to a matte finish

Catalog #	Description
359-100	4 5/8" (116mm), 25mm blades, straight
359-101	4 5/8" (116mm), 25mm blades, curved

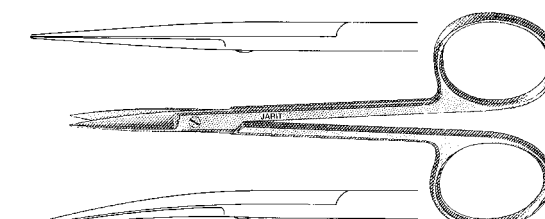

**Iris Scissors, Angled on the Side**

4½" (115mm), (Mirror Finish)

Catalog #	Description
360-102	27mm blades

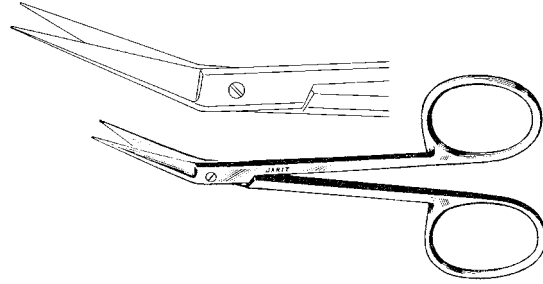

**Iris Scissors, Angled on the Side, Probe Point**

4½" (115mm), (Mirror Finish)

Catalog #	Description
360-103	27mm blades

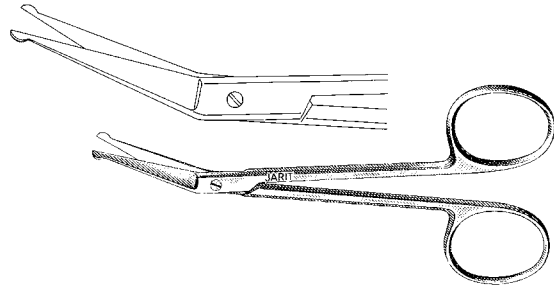

**Iris Scissors, Sharp-Sharp**

25mm blades, (Mirror Finish)

Catalog #	Description
360-104	3½" (94mm), straight
360-105	3½" (94mm), curved
360-110	4⅛" (105mm), extra delicate, straight
360-111	4⅛" (105mm), extra delicate, curved

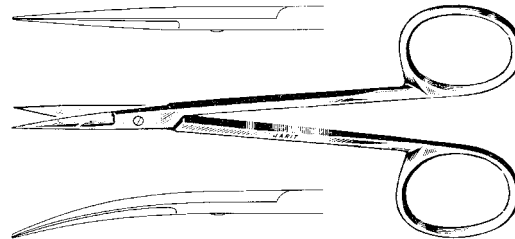

**Wilmer Conjunctival Scissors, Angled on the Flat**

4⅛" (104mm)

Catalog #	Description
360-115	Delicate, 15mm blades

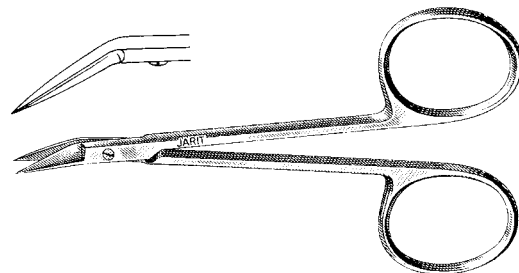

**Iris Scissors, Large Finger Rings**

3 7/8" (98mm), 22mm blades, (Satin Finish)

Catalog #	Description
360-117	Straight
360-118	Curved

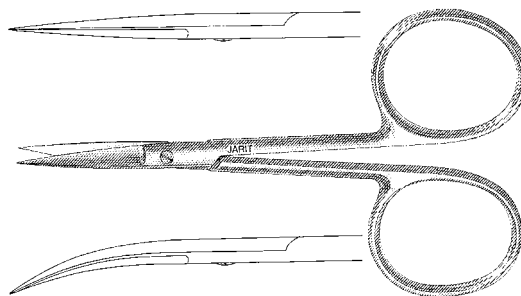

**Iris Scissors, Sharp-Sharp**

4" (103mm), delicate, 26mm blades, (Mirror Finish)

Catalog #	Description
360-120	Straight
360-121	Curved

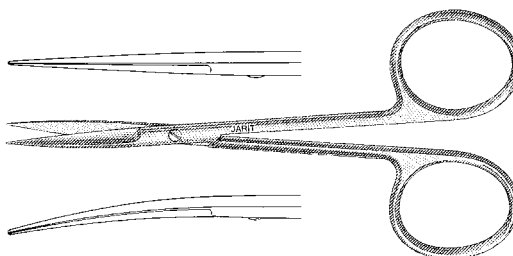

**Iris Scissors, Flat Shanks, Sharp-Sharp**

4 1/8" (104mm), 22mm blades, (Mirror Finish)

Catalog #	Description
360-122	Straight
360-123	Curved

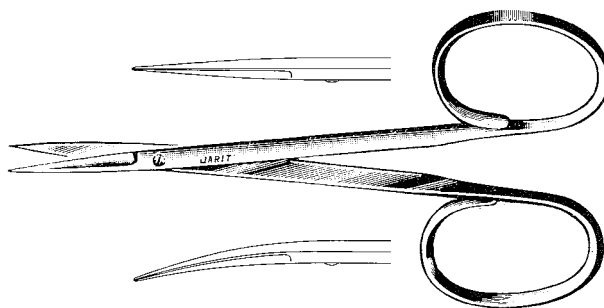

**Iris Scissors, Flat Shanks, Sharp-Sharp**

3 1/2" (96mm), delicate, 13.5mm blades, (Mirror Finish)

Catalog #	Description
360-125	Straight
360-126	Curved

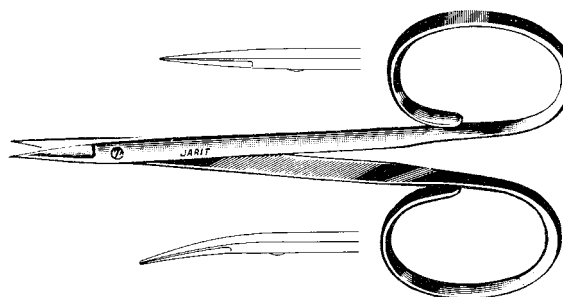

**Eye Utility Scissors, Flat Shanks, Blunt-Blunt**

37/8" (97mm), 16mm blades

Catalog #	Description
360-127	Straight
360-128	Curved

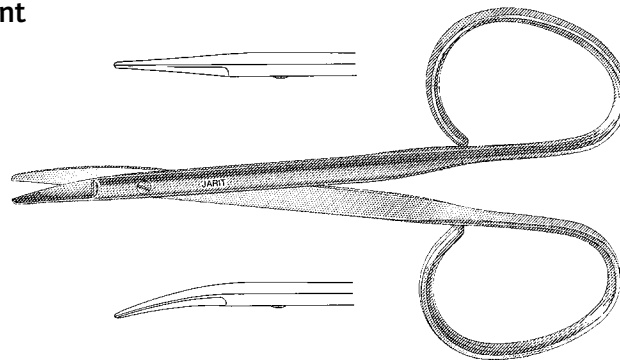

**Strabismus Scissors**

4 1/2" (114mm), 15mm blades

Catalog #	Description
360-130	Straight
360-131	Curved

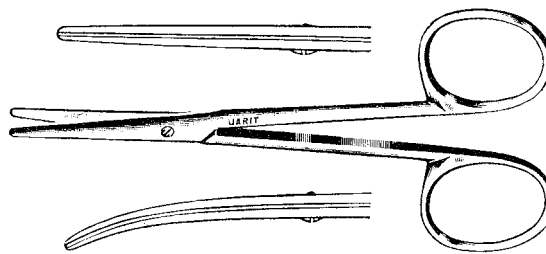

**Strabismus Scissors, Flat Shanks**

4 1/8" (106mm), 30mm blades

Catalog #	Description
360-134	Straight
360-135	Curved

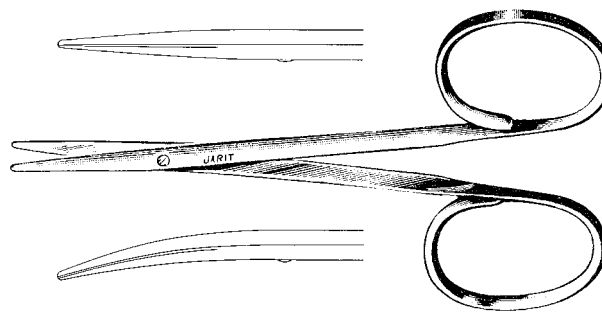

**Stevens Tenotomy Scissors, Blunt-Blunt**

Catalog #	Description
360-138	4 1/2" (115mm), 13mm blades, straight, slender pattern
360-139	4 1/2" (115mm), 13mm blades, curved, slender pattern
360-140	4 1/8" (115mm), 12mm blades, straight, standard pattern
360-141	4 1/8" (115mm), 12mm blades, curved, standard pattern

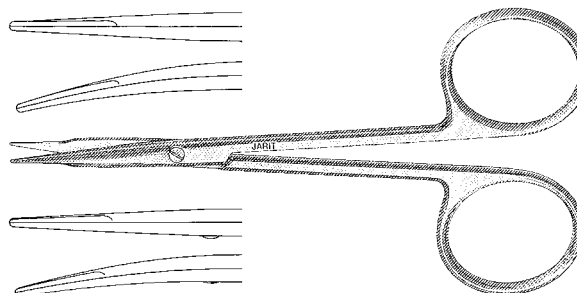

**Stevens Tenotomy Scissors, Blunt-Blunt**

3 7/8" (98mm), 13mm blades, flat shanks

Catalog #	Description
360-142	Straight
360-143	Curved

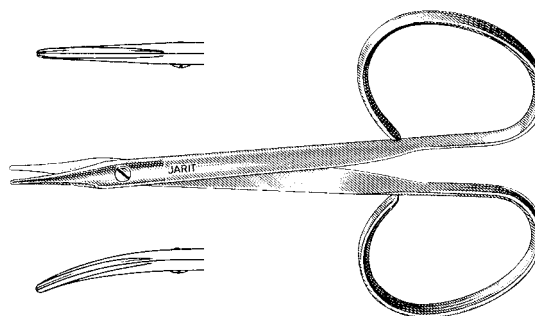

**Stevens Stitch Scissors, Curved Sharp Tips**

Catalog #	Description
360-148	4 1/8" (105mm), 14mm blades

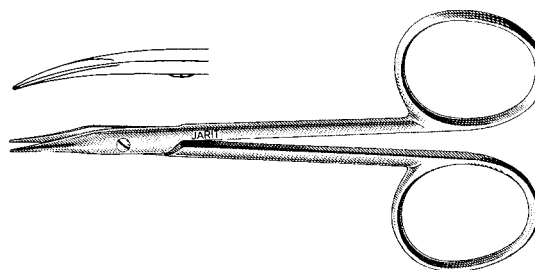

**Stevens Stitch Scissors, Flat Shanks, Curved, Sharp Tips**

Catalog #	Description
360-149	3 7/8" (98mm), 12mm blades

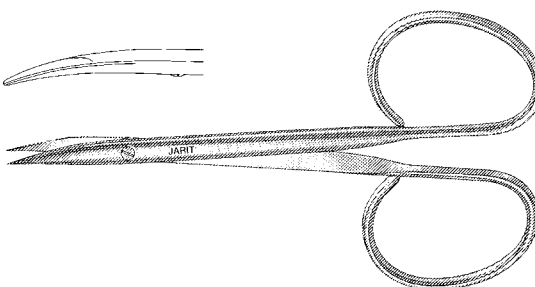

**Stitch Scissors, Semi-Sharp Tips**

3 7/8" (100mm), 16.5mm blades

Catalog #	Description
360-154	Straight
360-155	Curved

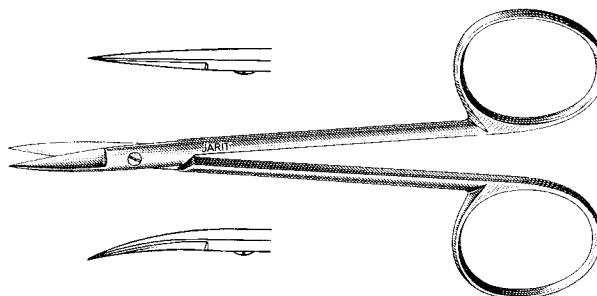



**Metzenbaum-Lahey Scissors, Carb-Edge™, (Satin Finish)**

Manufactured from high grade German surgical stainless steel which is ground and polished to a satin finish

Catalog #	Description
101-250	5¾" (145mm), straight
101-251	5¾" (145mm), curved

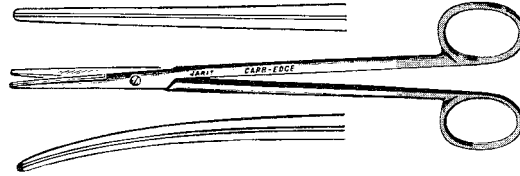

**Metzenbaum-Lahey Scissors, Carb-Edge, (Matte Finish)**

Manufactured from high grade German surgical stainless steel which is glass beaded to a matte finish

Catalog #	Description
103-250	5⅞" (149mm), straight
103-251	5⅞" (149mm), curved

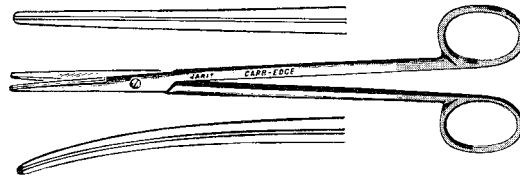

**Metzenbaum-Lahey Scissors, Carb-Edge**

delicate, sharp-sharp

Catalog #	Description
101-252	5¾" (145mm), straight
101-253	5¾" (145mm), curved

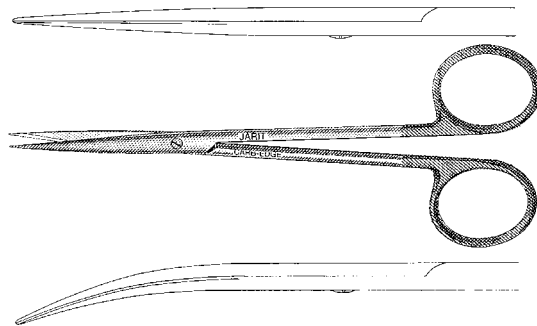

**Petit-Point® Reynolds Scissors, Carb-Edge**

5 1/8" (130mm)

Catalog #	Description
101-255	Curved, one blade serrated

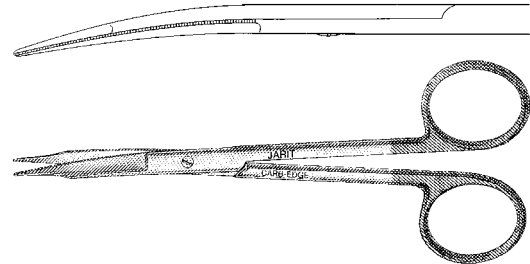

**Metzenbaum Scissors, Carb-Edge**

7" (179mm), sharp-sharp

Catalog #	Description
101-257	Straight
101-259	Delicate, curved

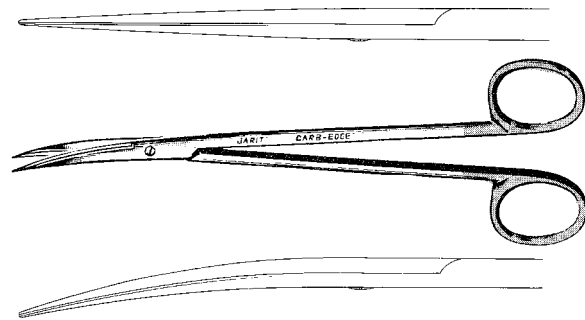

**Metzenbaum Scissors, Carb-Edge**

7" (179mm)

Catalog #	Description
101-260	Delicate, straight

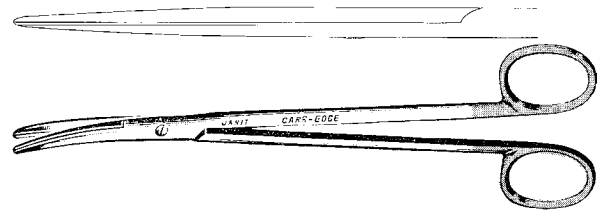

**Metzenbaum Scissors, Carb-Edge, (Satin Finish)**

7" (179mm)

Manufactured from high grade German surgical stainless steel which is ground and polished to a satin finish

Catalog #	Description
101-261	Delicate, curved

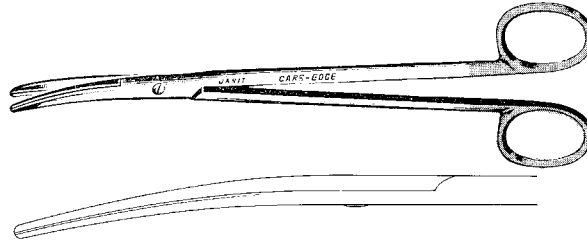

**Metzenbaum Scissors, Carb-Edge, (Matte Finish)**

7" (179mm)

Manufactured from high grade German surgical stainless steel which is glass beaded to a matte finish

Catalog #	Description
103-261	Delicate, curved

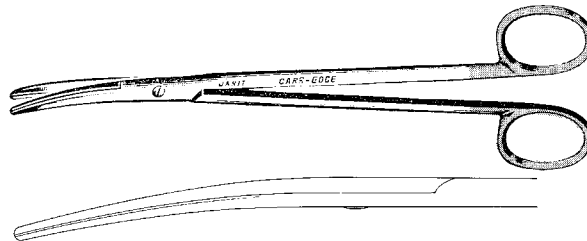

**Iris Scissors, Carb-Edge**

4 1/2" (114mm)

Catalog #	Description
101-300	Straight
101-301	Curved

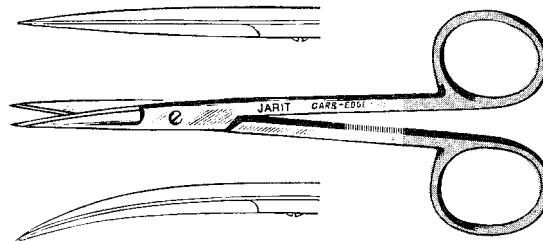

**Strabismus Scissors, Carb-Edge**

4 1/2" (114mm)

Catalog #	Description
101-310	Straight
101-311	Curved

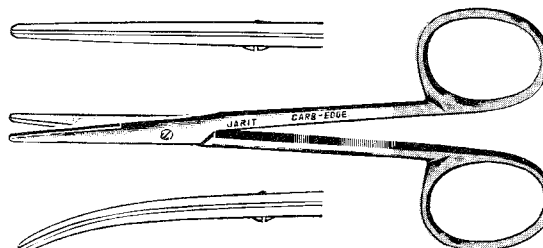

**Metzenbaum-Lahey Scissors, Supercut**

5<sup>5</sup>/<sub>8</sub>" (143mm)

Catalog #	Description
102-119	Straight
102-120	Curved

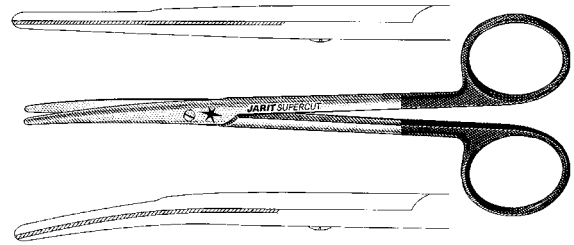

**Metzenbaum Scissors, Supercut**

Catalog #	Description
102-122	7" (180mm), curved
102-125	9 <sup>1</sup> / <sub>4</sub> " (232mm), curved

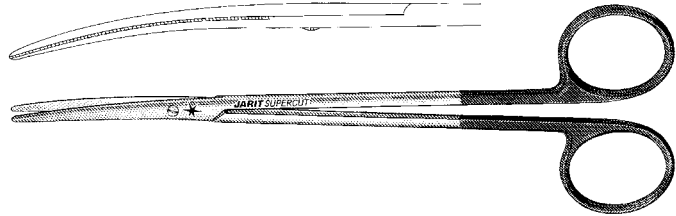

**Iris Scissors, Supercut**

4<sup>5</sup>/<sub>8</sub>" (116mm)

Catalog #	Description
102-130	Straight
102-131	Curved

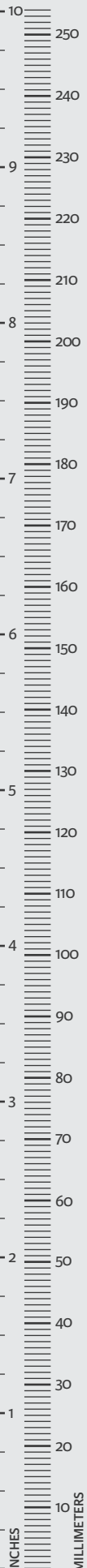
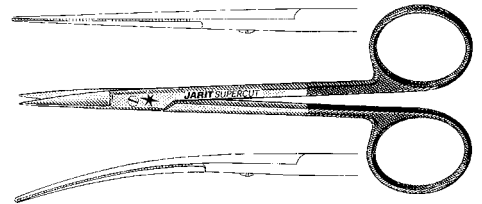

**Stevens Tenotomy Scissors, Supercut**

blunt tips

Catalog #	Description
102-138	4 <sup>3</sup> / <sub>8</sub> " (112mm), 13mm blades, straight, slender pattern
102-139	4 <sup>3</sup> / <sub>8</sub> " (112mm), 13mm blades, curved, slender pattern
102-140	4 <sup>1</sup> / <sub>4</sub> " (107mm), 12mm blades, straight, standard pattern
102-141	4 <sup>1</sup> / <sub>4</sub> " (107mm), 12mm blades, curved, standard pattern

Standard shown below. Supercut available.

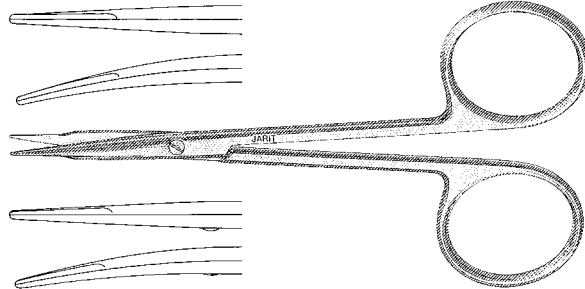

**Knight Nasal Scissors, Supercut**

6<sup>3</sup>/<sub>4</sub>" (171mm)

Catalog #	Description
102-180	30mm blades

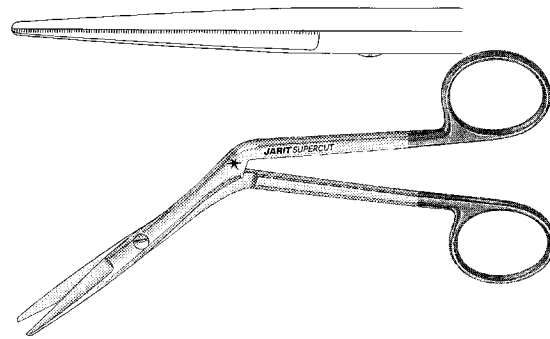

**Plastic Surgery Scissors, Supercut**

4<sup>3</sup>/<sub>4</sub>" (121mm)

Catalog #	Description
102-200	Straight
102-202	Curved

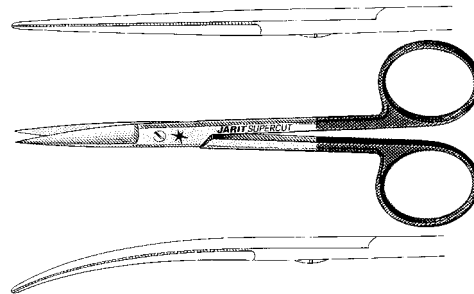

**Castanares Face Lift Scissors, Supercut**

6<sup>1</sup>/<sub>4</sub>" (157mm)

Catalog #	Description
102-205	Straight

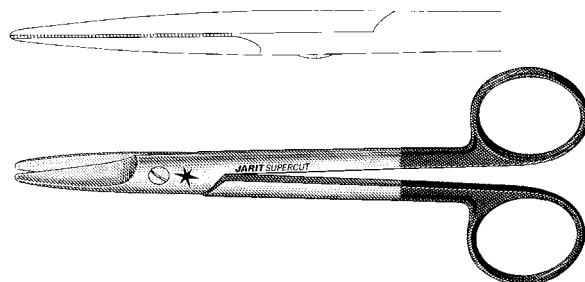

**Gorney Plastic Surgery Scissors, Supercut**

7¼" (185mm)

Catalog #	Description
102-210	Straight
102-211	Curved

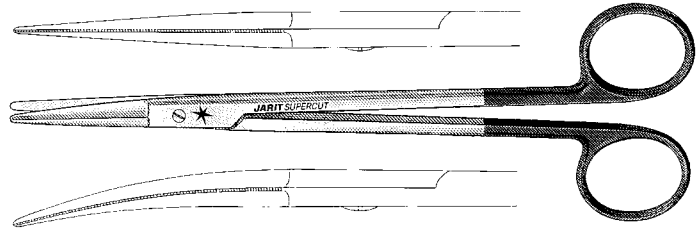

**Kaye Face Lift Scissors, Supercut**

curved beveled blades have semi-sharp outer edges

Catalog #	Description
102-215	5⅝" (142mm)
102-216	7¾" (194mm)

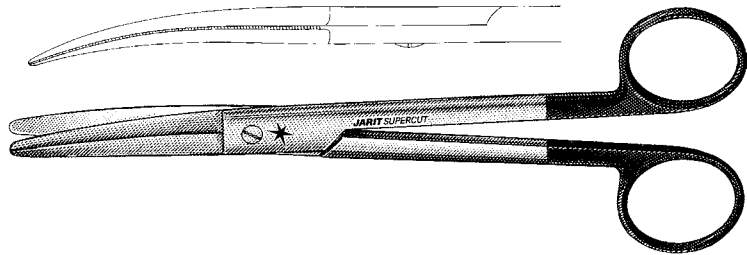

**Freeman-Gorney Face Lift Scissors, Supercut**

7¼" (184mm)

beveled blades have semi-sharp outer edges and flat, tapered tips; flared shanks

Catalog #	Description
102-220	Straight
102-221	Curved

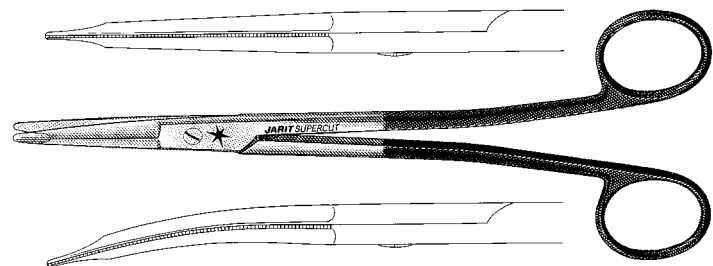

**Freeman-Kaye Face Lift Scissors, Supercut**

7¼" (184mm)

beveled blades have semi-sharp outer edges and flat, tapered tips;  
flared shanks

Catalog #	Description
102-225	Straight
102-226	Curved

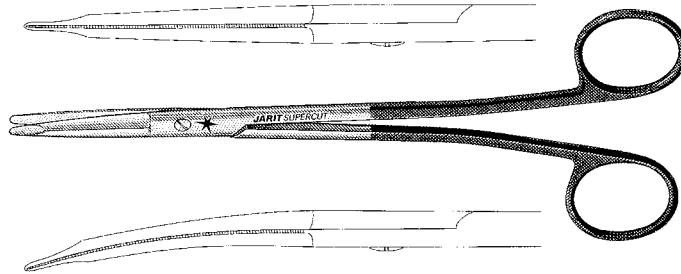

**Freeman Rhytidectomy Scissors, Supercut**

7" (178mm)

with flat tips; flared shanks

Catalog #	Description
102-229	Curved

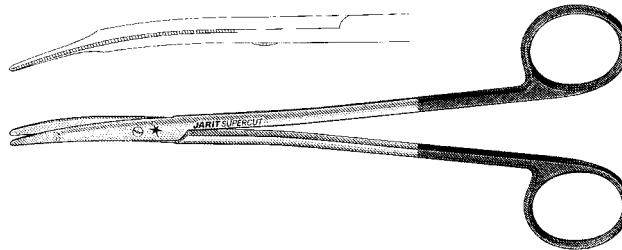

**Gorney Platysma Scissors, Supercut**

9¼" (232mm)

beveled blades have semi-sharp outer edges and flat,  
tapered tips; flared shanks

Catalog #	Description
102-230	Straight
102-231	Curved

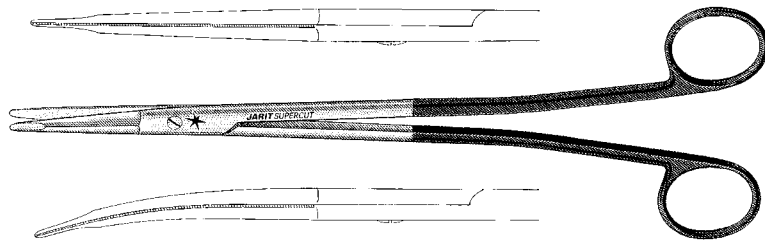

**Fomon Lateral Scissors, Supercut**

4½" (114mm)

Catalog #	Description
102-235	Full curved

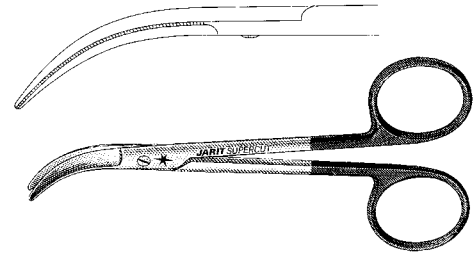

**Fomon Dorsal Scissors, Supercut**

5½" (140mm)

Catalog #	Description
102-236	Angled on flat

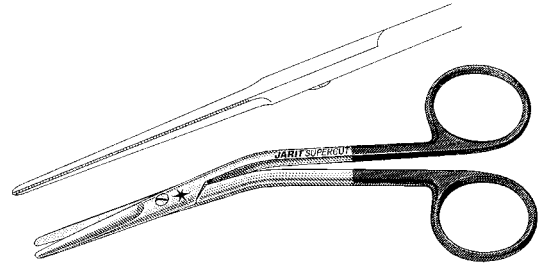

**Cottle Dorsal Scissors, Supercut**

6" (155mm)

Catalog #	Description
102-238	Angled on flat

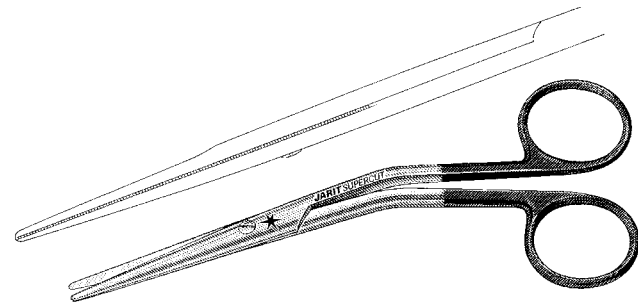

**Par Style Plastic and Recon Scissors, Supercut**  
curved

Catalog #	Description
102-240	4½" (113mm)
102-242	5⅝" (144mm)

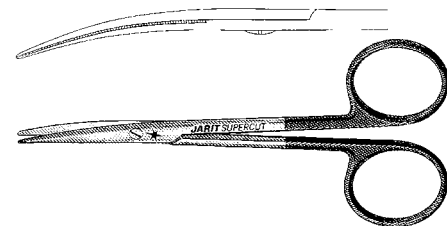

**Reynolds Petit-Point Scissors, Supercut**

5⅛" (129mm)

Catalog #	Description
102-245	Curved

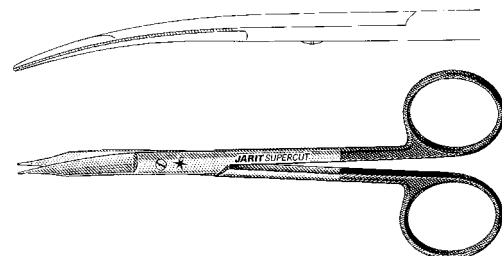



### Converse Needle Holder

Catalog #	Description
120-090	4 <sup>3</sup> / <sub>8</sub> " (112mm), large finger rings

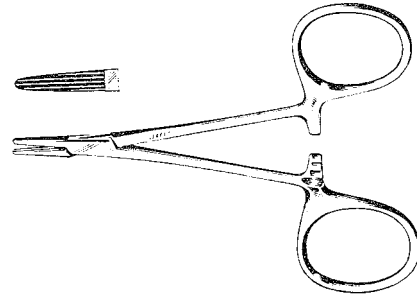

### Brown Needle Holder

Catalog #	Description
120-095	5 <sup>1</sup> / <sub>4</sub> " (133mm), rounded jaws

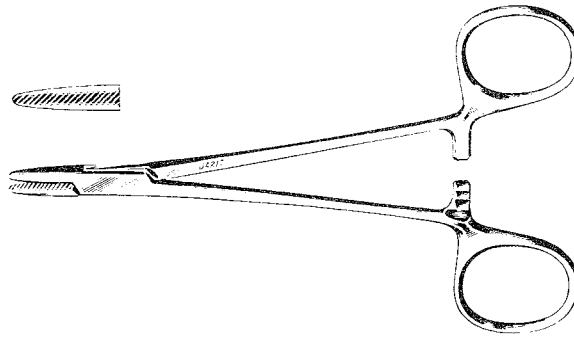

### Neivert Needle Holder

Catalog #	Description
120-097	4 <sup>7</sup> / <sub>8</sub> " (123mm), thumb ring turned up

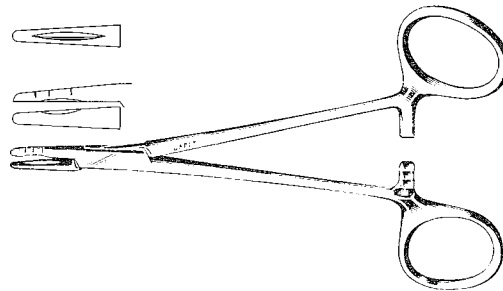

### Derf Needle Holder

Catalog #	Description
120-100	4 <sup>3</sup> / <sub>4</sub> " (120mm), grooved jaws

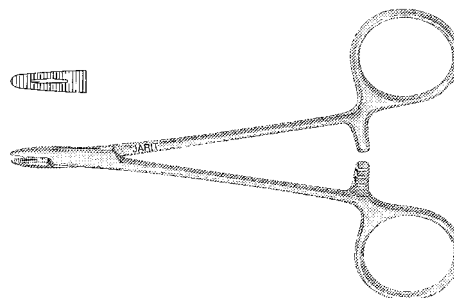

**Baumgartner Needle Holder**

Catalog #	Description
120-105	5 1/4" (133mm), solid jaws

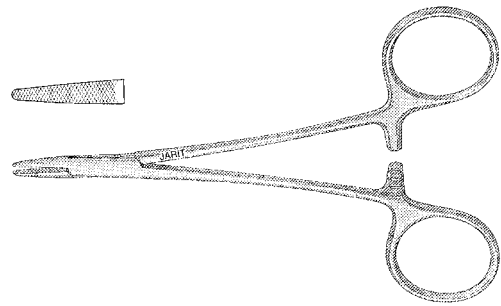

**Baumgartner Needle Holder**

Catalog #	Description
120-110	5 1/4" (133mm), grooved jaws

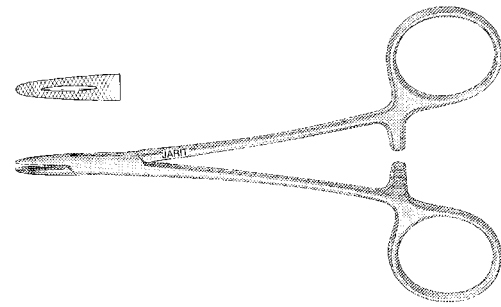

**Hegar-Baumgartner Needle Holder**

Catalog #	Description
120-112	5 3/4" (146mm), solid jaws

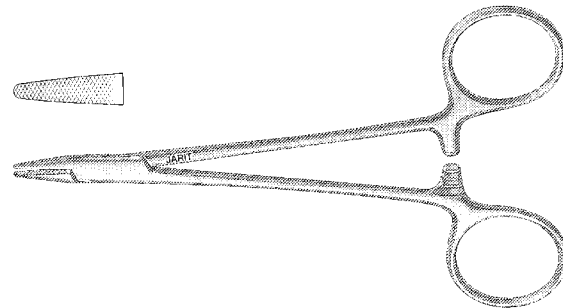

**Collier Needle Holder**

Catalog #	Description
120-115	5 3/8" (135mm), grooved jaws

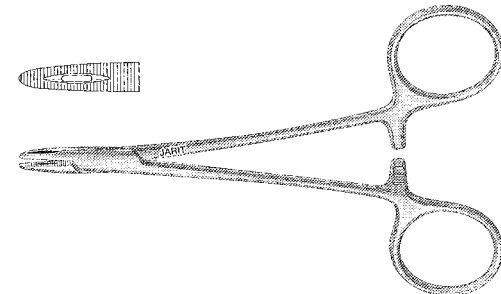

### Webster Needle Holder

Catalog #	Description
120-118	4½" (115mm), smooth jaws

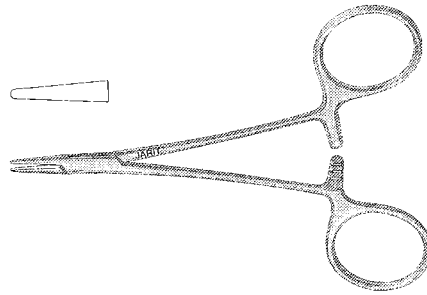

### Halsey Needle Holder

Catalog #	Description
120-120	5⅜" (135mm), smooth jaws

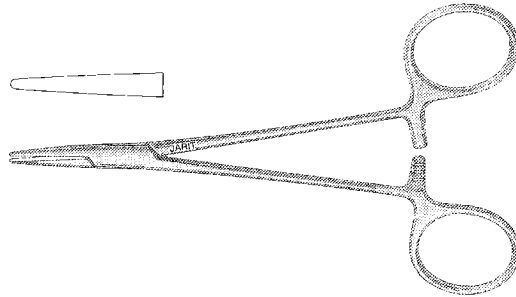

### Crile-Wood Needle Holders

grooved jaws

Catalog #	Description
120-130	6" (152mm)
120-131	7¼" (183mm)

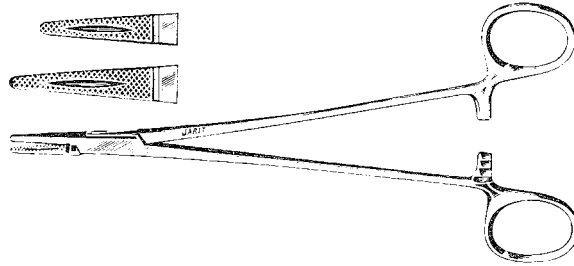

### Petit-Point Olsen-Hegar Needle Holders

4¾" (120mm)

Catalog #	Description
120-148	Serrated
120-149	Smooth

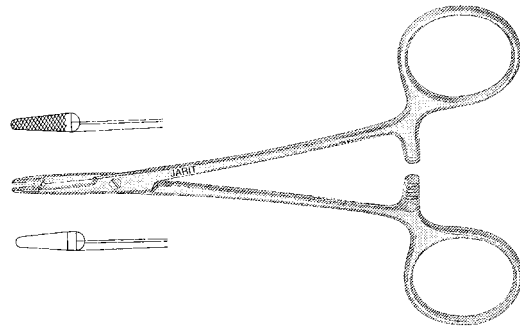

### Bayonet Needle Holder

Catalog #	Description
120-215	6½" (168mm), rounded fine tapered jaws

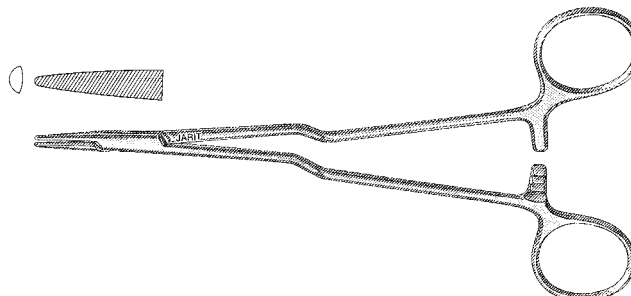

**Neivert Needle Holder, Carb-Bite**

4000 teeth per square inch, for use with 4.0 and 5.0 suture

Catalog #	Description
121-097	5" (126mm), thumb ring turned up

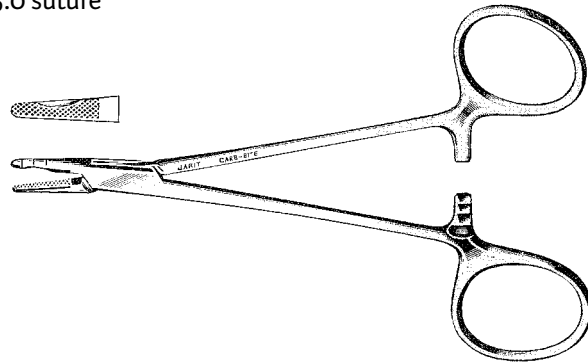

**Derf Needle Holder, Carb-Bite**

4000 teeth per square inch, for use with 4.0, 5.0, 6.0 suture

Catalog #	Description
121-100	4 3/4" (120mm)

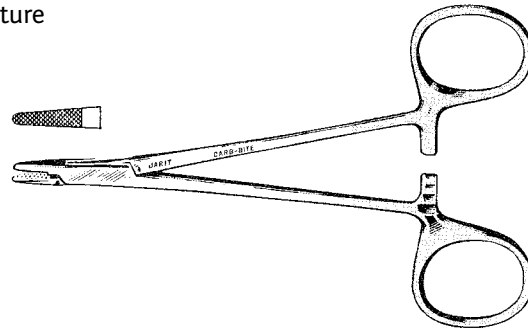

**Baumgartner Needle Holder, Carb-Bite, (Satin Finish)**

4000 teeth per square inch, for use with 2.0, 3.0, 4.0 suture  
Manufactured from high grade German surgical stainless steel which is ground and polished to a satin finish

Catalog #	Description
121-105	5 1/4" (132mm)

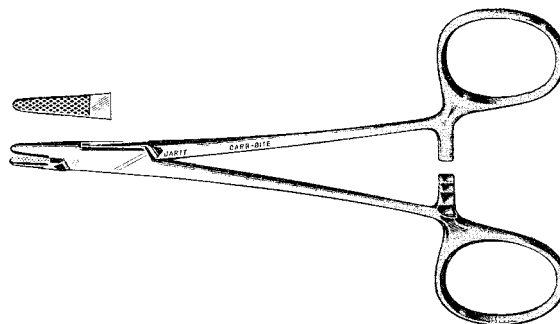

**Baumgartner Needle Holder, Carb-Bite, (Matte Finish)**

4000 teeth per square inch, for use with 2.0, 3.0, 4.0 suture  
Manufactured from high grade German surgical stainless steel which is glass beaded to a matte finish

Catalog #	Description
123-105	5 1/4" (132mm)

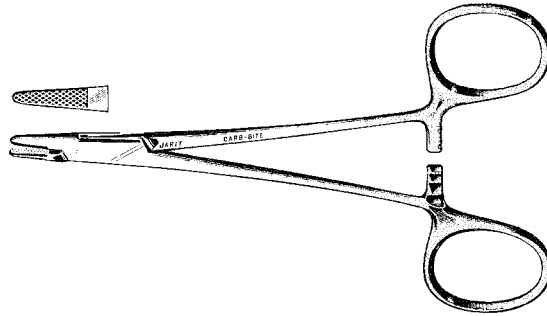

**Hegar-Baumgartner Needle Holder, Carb-Bite, (Satin Finish)**

2500 teeth per square inch, for use with 2.0, 3.0, 4.0 suture  
Manufactured from high grade German surgical stainless steel which is ground and polished to a satin finish

Catalog #	Description
121-106	5 3/4" (147mm)

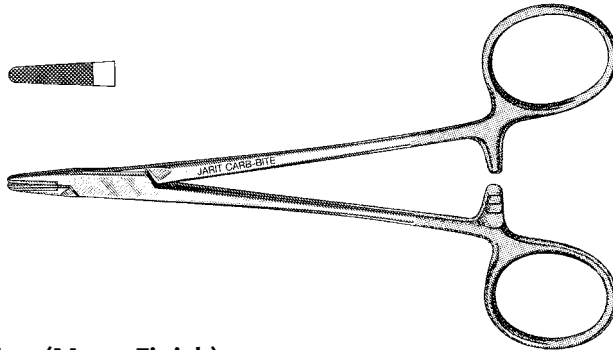

**Hegar-Baumgartner Needle Holder, Carb-Bite, (Matte Finish)**

2500 teeth per square inch, for use with 2.0, 3.0, 4.0 suture  
Manufactured from high grade German surgical stainless steel which is glass beaded to a matte finish

Catalog #	Description
123-106	5 3/4" (147mm)

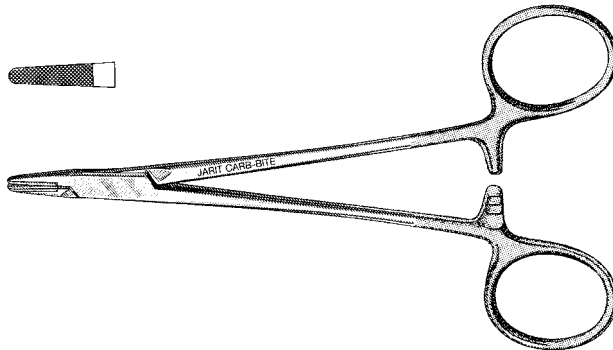

**Par Style Plastic and Recon Needle Holder, Carb-Bite**

7000 teeth per square inch, for use with 6.0, 7.0, 8.0 suture

Catalog #	Description
121-115	4 5/8" (117mm), serrated
121-116	4 5/8" (117mm), smooth

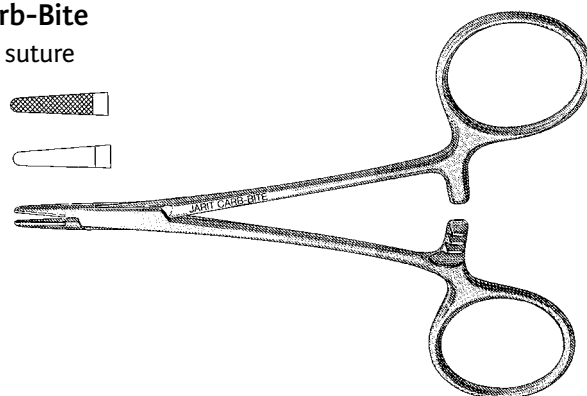

**Webster Needle Holder, Carb-Bite**

3600 teeth per square inch, for use with 5.0 and 6.0 suture

Catalog #	Description
121-118	4 5/8" (118mm), smooth
121-119	4 5/8" (118mm), serrated

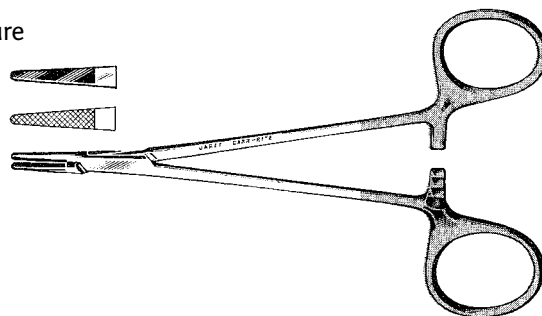

**Halsey Needle Holder, Carb-Bite**

for use with 4.0 and 5.0 suture

Catalog #	Description
121-120	5 1/4" (133mm), smooth

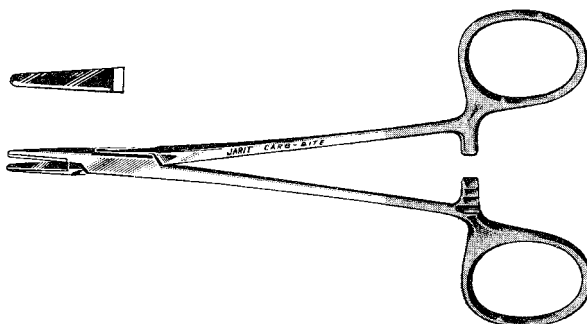

**Halsey Needle Holder, Carb-Bite**

4000 teeth per square inch, for use with 4.0 and 5.0 suture

Catalog #	Description
121-121	5 1/4" (133mm), serrated

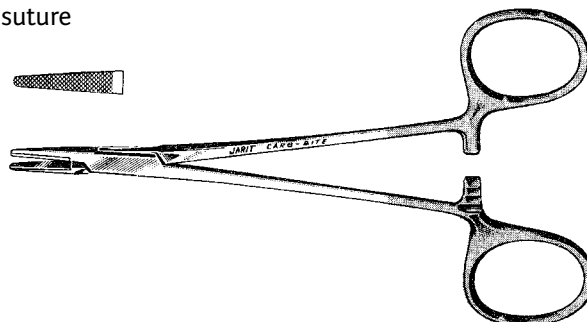

**Crile-Wood Needle Holder, Carb-Bite, (Satin Finish)**

4000 teeth per square inch, for use with 4.0, 5.0 and 6.0 suture  
Manufactured from high grade German surgical stainless steel which is ground and polished to a satin finish

Catalog #	Description
121-130	6" (152mm)
121-131	7" (180mm)

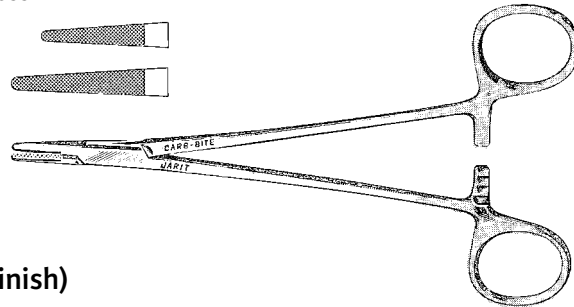

**Crile-Wood Needle Holder, Carb-Bite, (Matte Finish)**

4000 teeth per square inch, for use with 4.0, 5.0 and 6.0 suture  
Manufactured from high grade German surgical stainless steel which is glass beaded to a matte finish

Catalog #	Description
123-130	6" (152mm)
123-131	7" (180mm)

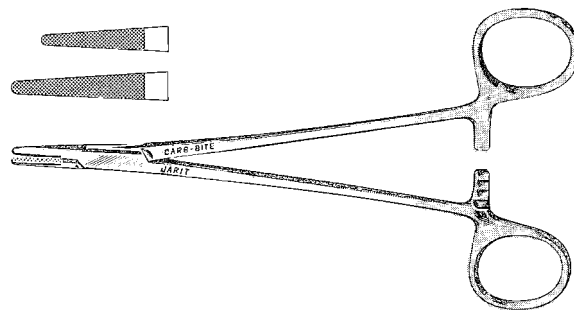

**Petit-Point® Olsen-Hegar Needle Holder/Scissors, Carb-Bite**

7000 teeth per square inch, for use with 6.0, 7.0, 8.0 suture

Catalog #	Description
121-148	4¾" (120mm), serrated
121-149	4¾" (120mm), smooth

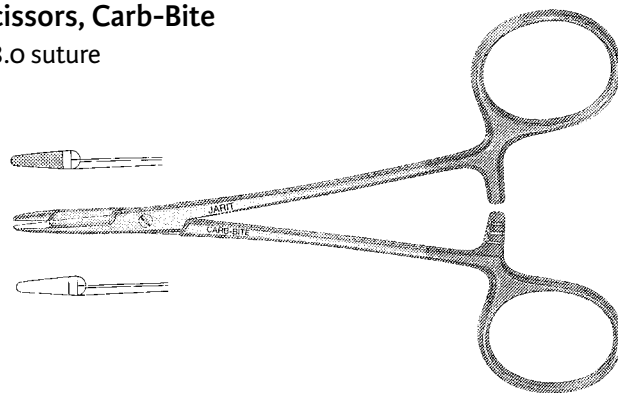

**Petit-Point Ryder Needle Holders**

7000 teeth per square inch, for use with 4.0, 5.0 and 6.0 suture  
1mm serrated and smooth jaws

Catalog #	Description
121-170	4⅞" (124mm), serrated
121-171	4⅞" (124mm), smooth
121-172	6¼" (156mm), serrated
121-173	6¼" (156mm), smooth

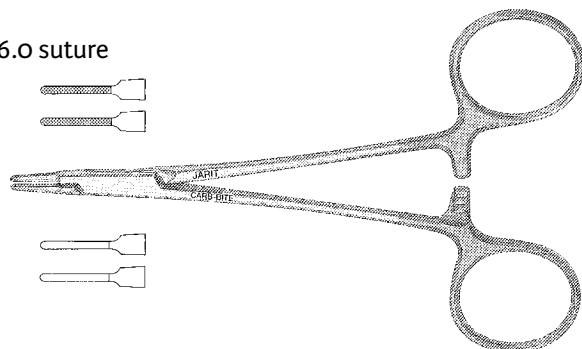

### Castroviejo Needle Holders, Flat Serrated Handles

for use with 5.0 and 6.0 suture  
5½" (140mm), 11.5mm smooth jaws,  
delicate tips 1.5mm

Catalog #	Description
355-404	Curved, locking
355-404NL	Curved, non-locking
355-405	Straight, locking
355-405NL	Straight, non-locking

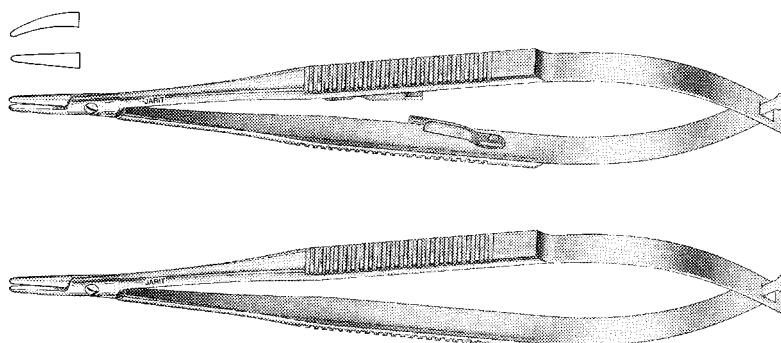

### Castroviejo Needle Holders, Flat Serrated Handles

for use with 6.0, 7.0 and 8.0 suture  
5½" (140mm), 10.5mm smooth jaws,  
extra delicate tips 1.2mm

Catalog #	Description
355-406	Straight, locking
355-406NL	Straight, non-locking
355-407	Curved, locking
355-407NL	Curved, non-locking

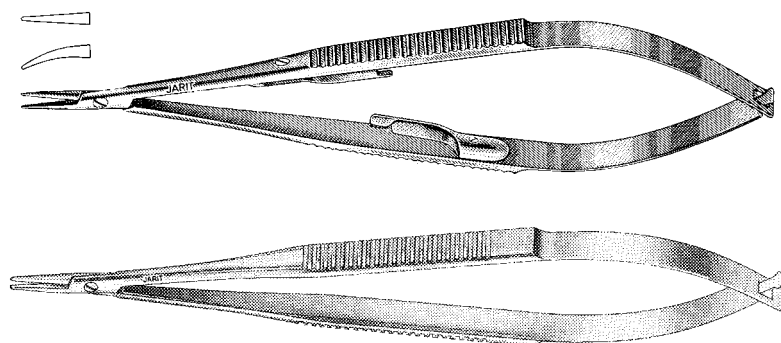



### Castroviejo Needle Holders, Wide Serrated Handles

for use with 6.0, 7.0 and 8.0 suture  
5" (127mm), 9mm smooth jaws,  
microsurgery tips 0.6mm

Catalog #	Description
355-408	Straight, non-locking
355-409	Curved, non-locking
355-410	Straight, locking
355-411	Curved, locking

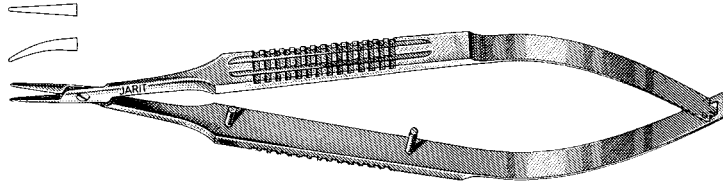

### Castroviejo Needle Holders, Carb-Bite

flat serrated handles, for use with 6.0 and 7.0 suture  
5½" (140mm), 11mm straight jaws,  
extra delicate tips 1.2mm

Catalog #	Description
355-412	Smooth, locking
355-412NL	Smooth, non-locking
355-413	Serrated, locking
355-413NL	Serrated, non-locking

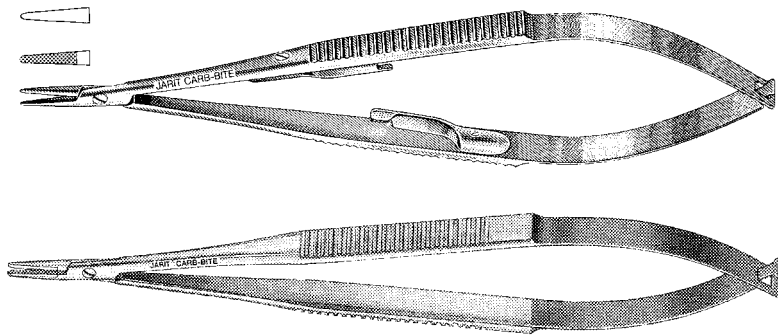

**Petit-Point Jacobson Mosquito Forceps**

Catalog #	Description
105-088	4 <sup>7</sup> / <sub>8</sub> " (124mm), straight
105-089	4 <sup>7</sup> / <sub>8</sub> " (124mm), curved

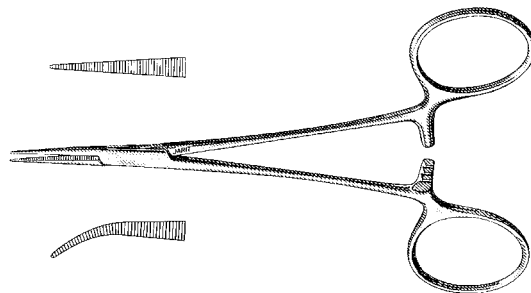

**Petit-Point Mosquito Forceps**

Catalog #	Description
105-090	3 <sup>7</sup> / <sub>8</sub> " (100mm), straight
105-091	3 <sup>7</sup> / <sub>8</sub> " (100mm), curved
105-095	4 <sup>3</sup> / <sub>4</sub> " (120mm), straight
105-096	4 <sup>3</sup> / <sub>4</sub> " (120mm), curved

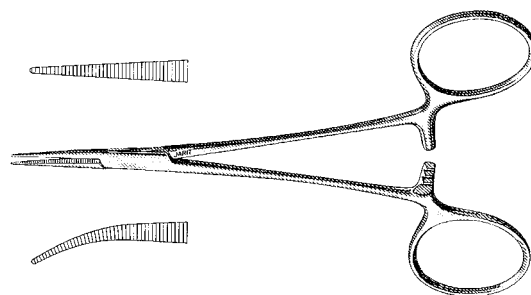

**Petit-Point Mosquito Forceps**

Catalog #	Description
105-098	6" (152mm), straight
105-099	6" (152mm), curved

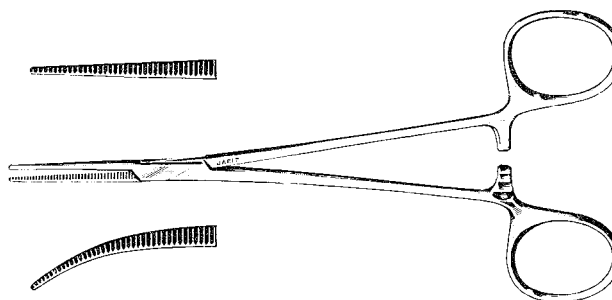

**Petit-Point Crile Forceps**

Catalog #	Description
105-118	5 <sup>5</sup> / <sub>8</sub> " (143mm), straight
105-119	5 <sup>5</sup> / <sub>8</sub> " (143mm), curved

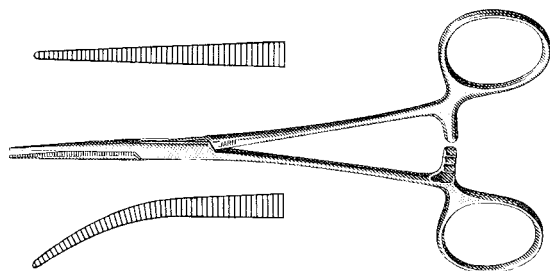

**Petit-Point Pean Forceps**

Catalog #	Description
105-163	5½" (140mm), straight
105-164	5½" (140mm), curved

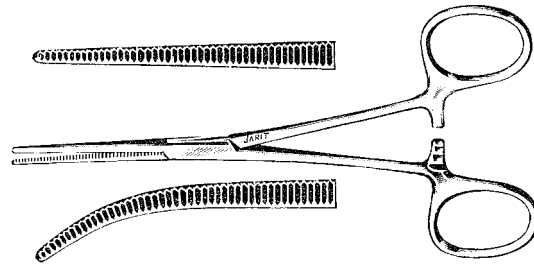

**Petit-Point Ochsner Forceps**

Catalog #	Description
105-233	5½" (140mm), straight
105-234	5½" (140mm), curved

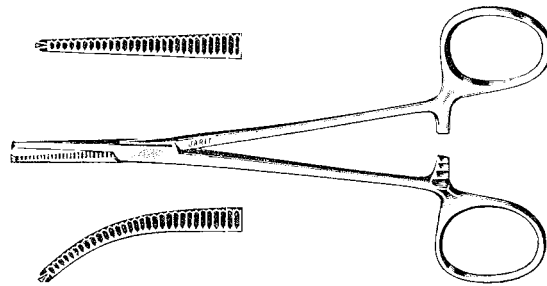

**Halstead Mosquito Forceps, (Mirror Finish)**

Manufactured from high grade German surgical stainless steel which is ground and polished to a mirror finish

Catalog #	Description
105-100	5" (127mm), straight
105-102	5" (127mm), curved

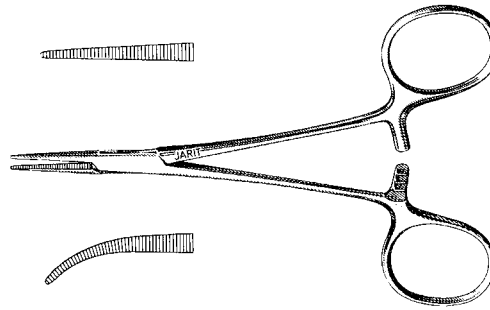

**Halstead Mosquito Forceps, (Satin Finish)**

Manufactured from high grade German surgical stainless steel which is ground and polished to a satin finish

Catalog #	Description
106-100	5" (127mm), straight
106-102	5" (127mm), curved

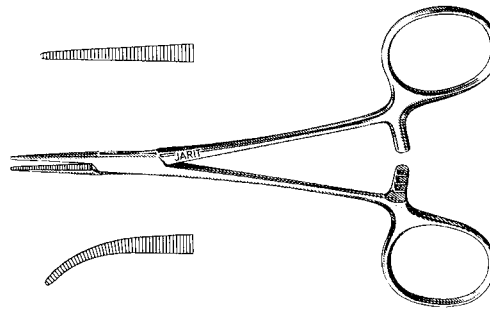

**Halstead Mosquito Forceps, (Matte Finish)**

Manufactured from high grade German surgical stainless steel which is glass beaded to a matte finish

Catalog #	Description
107-100	5" (127mm), straight
107-102	5" (127mm), curved

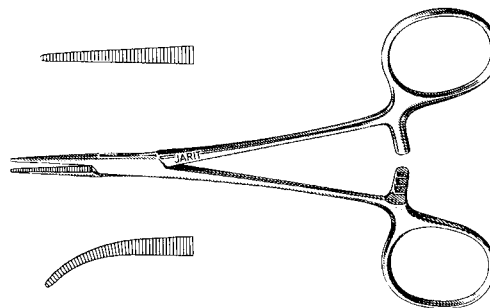

**Halstead Mosquito Forceps**

4 7/8" (124mm), 1 x 2 teeth, mirror finish

Catalog #	Description
105-110	Straight
105-112	Curved

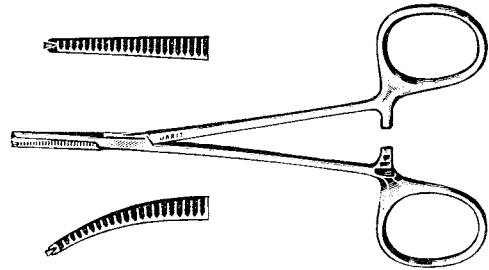

**Hartman Mosquito Forceps, (Mirror Finish)**

Manufactured from high grade German surgical stainless steel which is ground and polished to a mirror finish

Catalog #	Description
105-114	3 7/8" (100mm), straight
105-115	3 7/8" (100mm), curved

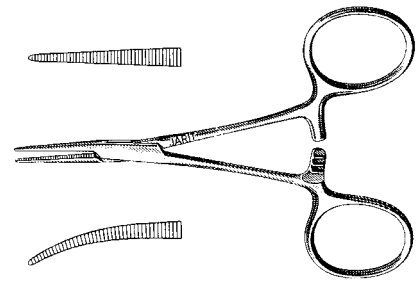

**Hartman Mosquito Forceps, (Matte Finish)**

Manufactured from high grade German surgical stainless steel which is glass beaded to a matte finish

Catalog #	Description
107-114	3 7/8" (100mm), straight
107-115	3 7/8" (100mm), curved

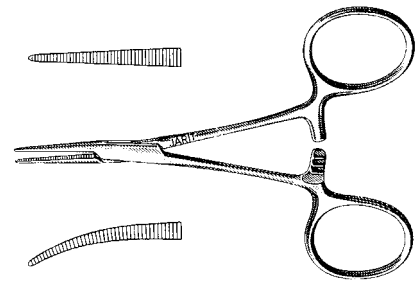

**Coller-Crile Forceps**

fine tapered tips

Catalog #	Description
105-142	5 5/8" (143mm), straight
105-143	6 1/4" (160mm), straight, mirror finish
105-144	5 5/8" (143mm), curved, mirror finish
105-145	6 1/4" (160mm), curved, mirror finish

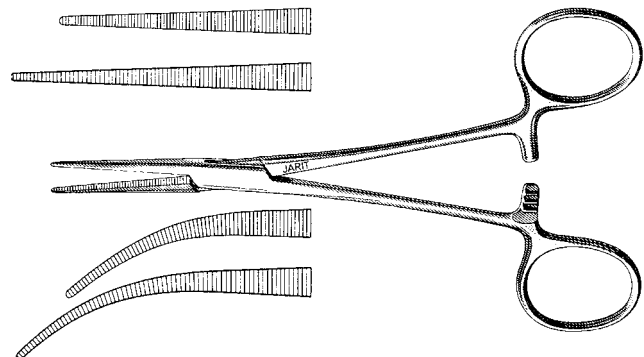

**Providence Hospital Forceps**

Catalog #	Description
105-160	5 5/8" (144mm), straight
105-161	5 5/8" (144mm), curved

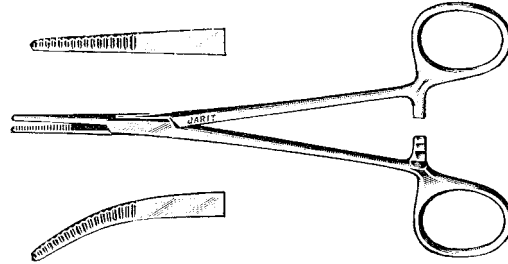

**Kocher Artery Forceps, (Mirror Finish)**

Manufactured from high grade German surgical stainless steel which is ground and polished to a mirror finish

Catalog #	Description
105-230	5 1/2" (140mm), straight
105-232	5 1/2" (140mm), curved

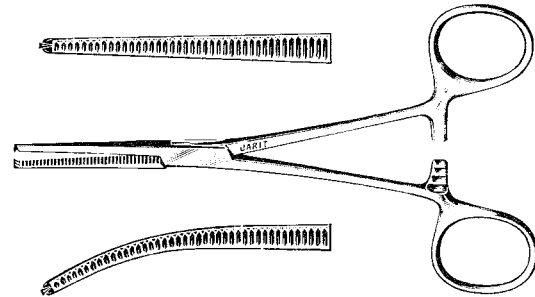

**Kocher Artery Forceps, (Satin Finish)**

Manufactured from high grade German surgical stainless steel which is ground and polished to a satin finish

Catalog #	Description
106-230	5 1/2" (140mm), straight
106-232	5 1/2" (140mm), curved

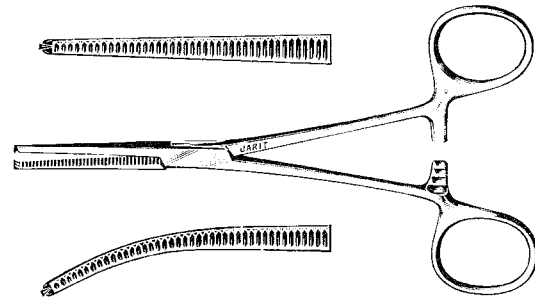

**Petit-Point Allis Tissue Forceps**

Catalog #	Description
135-095	5 1/8" (130mm), 3mm wide jaws, 4 x 5 teeth

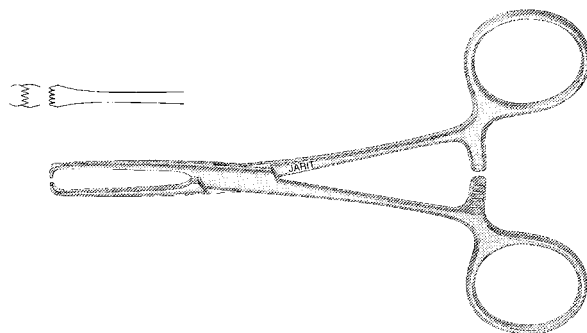

**Petit-Point Babcock Forceps**

Catalog #	Description
135-179	5 <sup>7</sup> / <sub>8</sub> " (148mm), jaw width 5.6mm
135-180	6" (155mm), jaw width 7.5mm

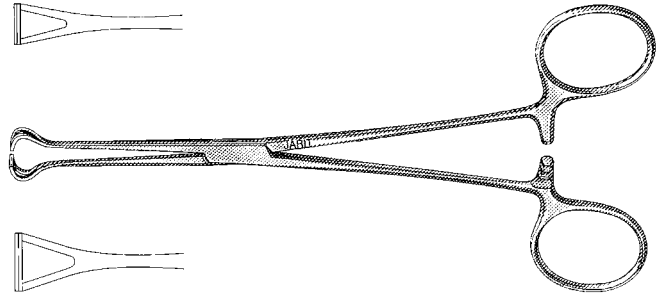

**Petit-Point Mixer Forceps**

Catalog #	Description
140-218	5 <sup>3</sup> / <sub>8</sub> " (137mm)

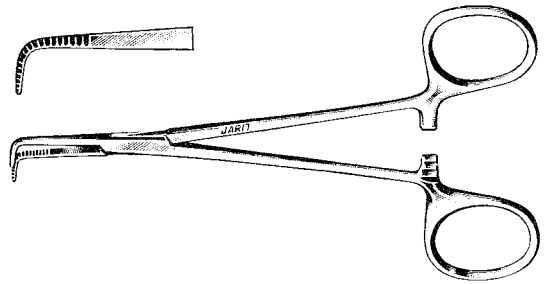

**Petit-Point Mixer Forceps**

Catalog #	Description
140-223	7 <sup>1</sup> / <sub>4</sub> " (185mm)

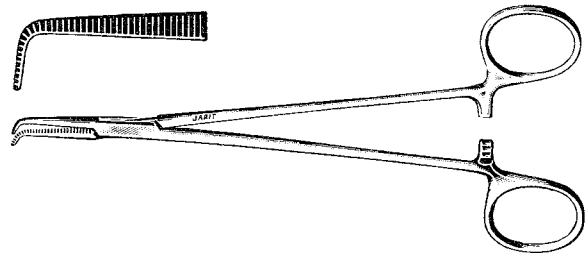

**Adson Dressing Forceps, Serrated, (Matte Finish)**

Manufactured from high grade German surgical stainless steel which is glass beaded to a matte finish

Catalog #	Description
130-230	4¾" (120mm)
130-231	4¾" (120mm), extra delicate, 0.8mm wide tip

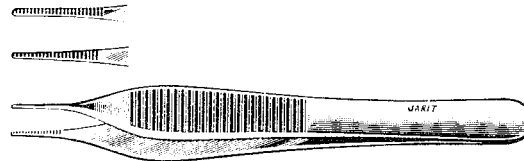

**Adson Dressing Forceps, Serrated, (Mirror Finish)**

Manufactured from high grade German surgical stainless steel which is ground and polished to a mirror finish

Catalog #	Description
129-230	4¾" (120mm)

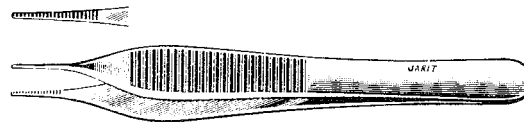

**Adson Dressing Forceps, (Satin Finish)**

Catalog #	Description
130-232	4¾" (120mm), cross-serrated



**Adson Tissue Forceps, 1 x 2 teeth, (Matte Finish)**

Manufactured from high grade German surgical stainless steel which is glass beaded to a matte finish

Catalog #	Description
130-234	4¾" (120mm)
130-235	4¾" (120mm), extra delicate, 0.8mm wide tip
130-237	4⅝" (117mm), angled jaw
130-238	4¾" (120mm), with tying platform

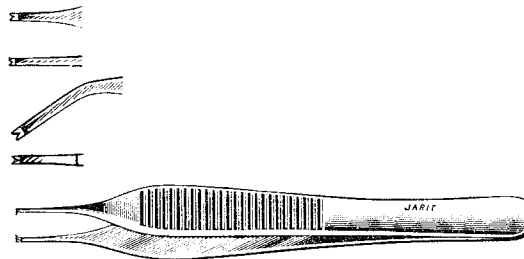

**Adson Tissue Forceps, 1 x 2 teeth, (Mirror Finish)**

Manufactured from high grade German surgical stainless steel which is ground and polished to a mirror finish

Catalog #	Description
129-234	4¾" (120mm)

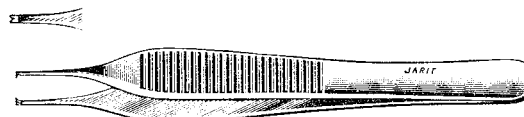

**Adson Tissue Forceps, Carb-Bite, (Mirror Finish)**

Catalog #	Description
130-236	4¾" (120mm)

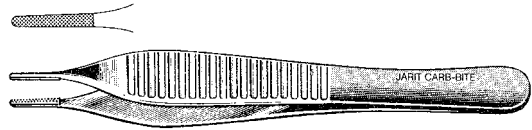

**Adson Tissue Forceps, (Satin Finish)**

Catalog #	Description
130-240	4¾" (120mm), 2 x 3 teeth

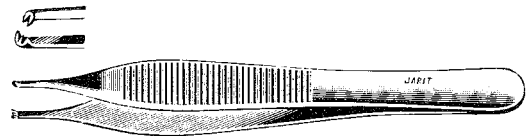

**Adson Dressing Forceps, (Satin Finish)**

Catalog #	Description
130-243	4¾" (120mm), cross serrated handle, matte



**Adson Tissue Forceps, (Satin Finish)**

Catalog #	Description
130-244	4¾" (120mm), 1 x 2 teeth, cross serrated handle, matte

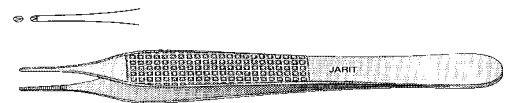

**Adson Tissue Forceps, (Matte Finish)**

Manufactured from high grade German surgical stainless steel which is glass beaded to a matte finish

Catalog #	Description
130-245	4¾" (120mm), 1 x 2 teeth, serrated

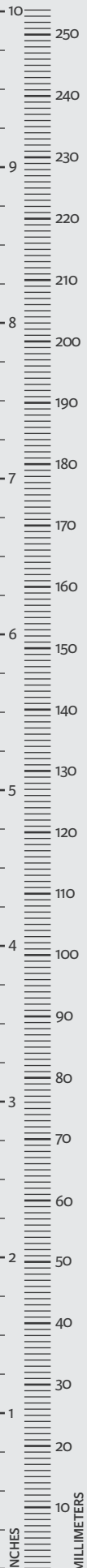
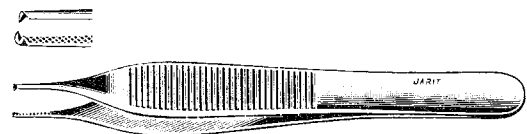



**Brown-Adson Tissue Forceps, 9 x 9 teeth, (Satin Finish)**

Manufactured from high grade German surgical stainless steel which is ground and polished to a satin finish

Catalog #	Description
130-260	4 <sup>7</sup> / <sub>8</sub> " (124mm)

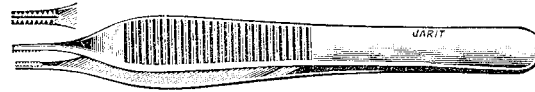

**Brown-Adson Tissue Forceps, 9 x 9 teeth, (Mirror Finish)**

Manufactured from high grade German surgical stainless steel which is ground and polished to a mirror finish

Catalog #	Description
129-260	4 <sup>7</sup> / <sub>8</sub> " (124mm)

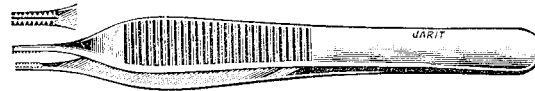

**Beasley-Babcock Tissue Forceps**

6 x 7 teeth

Catalog #	Description
130-262	4 <sup>7</sup> / <sub>8</sub> " (124mm)

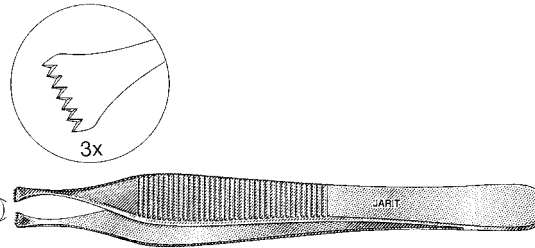

**Brown Tissue Forceps**

8 x 8 teeth

Catalog #	Description
130-265	6" (151mm)
130-266	8" (202mm)
130-267	10" (251mm)



**Brown-Adson Tissue Forceps, (Satin Finish)**

9 x 9 teeth, angled

Catalog #	Description
130-270	4 <sup>7</sup> / <sub>8</sub> " (124mm)

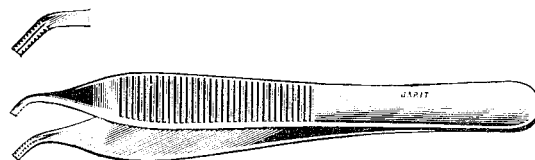

### Semken Dressing Forceps

serrated

Catalog #	Description
130-275	5" (126mm)
130-276	6" (152mm)



### Semken Tissue Forceps

Catalog #	Description
130-280	5" (126mm), 1 x 2 teeth
130-281	6" (154mm), 1 x 2 teeth
130-282	5" (126mm), 2 x 3 teeth

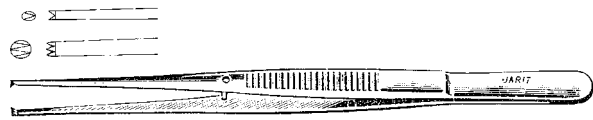

### McIndoe Dressing Forceps

Catalog #	Description
130-284	6" (153mm), serrated

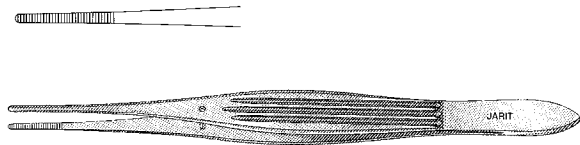

### Gillies Tissue Forceps

Catalog #	Description
130-286	6" (152mm), 1 x 2 teeth, cross-serrated

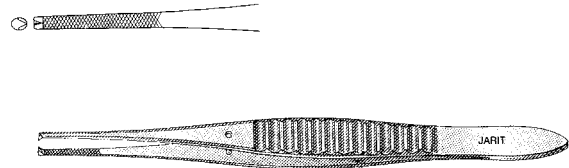

### Ferris-Smith Tissue Forceps

Catalog #	Description
130-289	6 3/4" (174mm), 1 x 2 teeth
130-290	6 3/4" (174mm), 2 x 3 teeth

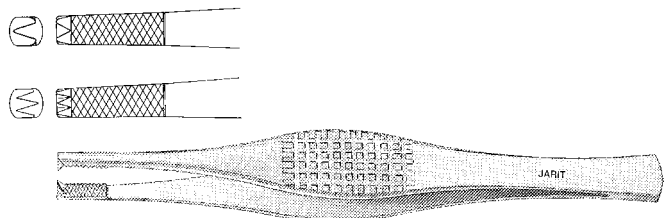

**Bonney Tissue Forceps**

3.4mm wide x 26mm length serrated jaws

Catalog #	Description
130-293	6¾" (173mm), 1 x 2 teeth
130-294	6¾" (173mm), 2 x 3 teeth

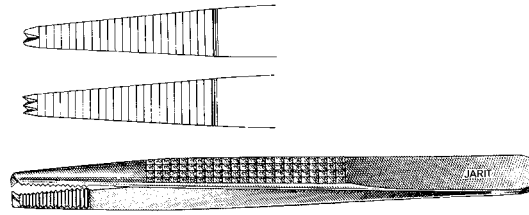

**Nelson Tissue Forceps**

6 x 7 teeth

Catalog #	Description
130-370	6" (152mm)

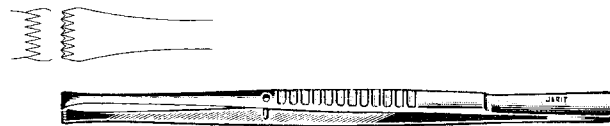

**Cushing Tissue Forceps**

straight, 1 x 2 teeth, scraper end

Catalog #	Description
130-405	6¾" (171mm), 1.5mm tips



**Cushing Tissue Forceps**

bayonet, 1 x 2 teeth, scraper end

Catalog #	Description
130-415	7¼" (181mm), 1.7mm tips

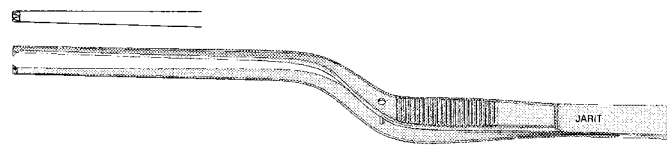

**Cushing-Brown Tissue Forceps**

straight, double row of 9 x 9 delicate teeth, scraper end

Catalog #	Description
130-440	6¾" (174mm)

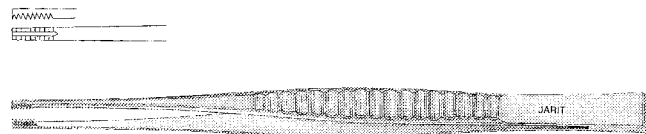

**Cushing-Brown Tissue Forceps**

bayonet, double row of 9 x 9 delicate teeth, scraper end

Catalog #	Description
130-442	7" (180mm)



**Adson Needle and Tissue Pulling Forceps, Carb-Bite**

1 x 2 teeth

Catalog #	Description
122-500	4 <sup>7</sup> / <sub>8</sub> " (123mm)
122-501	4 <sup>5</sup> / <sub>8</sub> " (119mm), delicate
122-502	5 <sup>7</sup> / <sub>8</sub> " (150mm)
122-503	5 <sup>7</sup> / <sub>8</sub> " (150mm), delicate

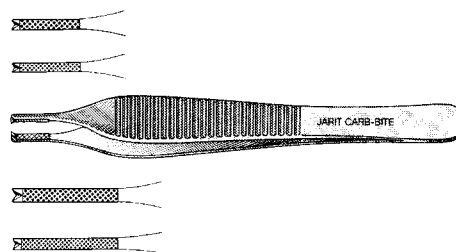

**Brown-Adson Needle and Tissue Pulling Forceps, Carb-Bite**

3 x 4 teeth

Catalog #	Description
122-510	4 <sup>7</sup> / <sub>8</sub> " (124mm)

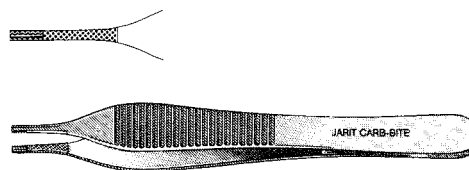

**Cushing Needle and Tissue Pulling Forceps, Carb-Bite**

Catalog #	Description
122-530	7" (176mm), Gutsch handle, scraper end, 1.8mm wide x 12mm length
122-535	7" (176mm), Delicate, 1.6mm wide x 8mm length

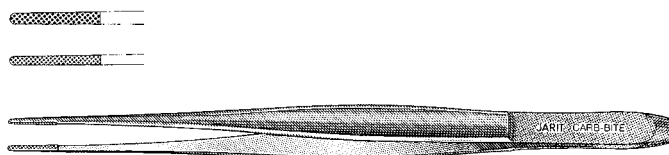

**Semken Needle and Tissue Pulling Forceps, Carb-Bite**

1 x 2 teeth

Catalog #	Description
122-590	6" (153mm), 1.7mm x 12mm tips
122-591	6" (153mm), 1mm x 12mm tips, delicate

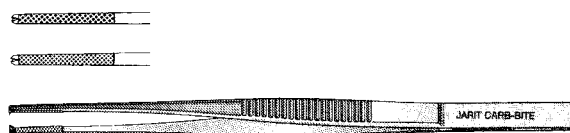

**Joseph Nasal Saws**

7½" (190mm), 1.3mm x 36mm saw blades

Catalog #	Description
420-100	Bayonet blade angled left
420-101	Bayonet blade angled right

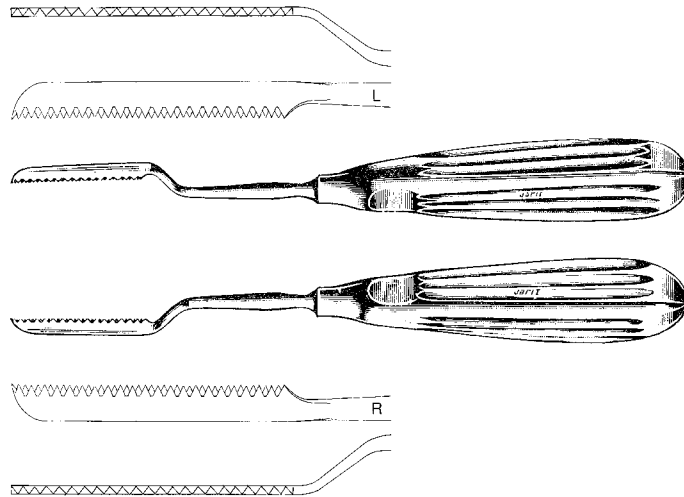

**Joseph Nasal Saw**

7¼" (183mm), 1.3mm x 36mm saw blades

Catalog #	Description
420-102	Straight

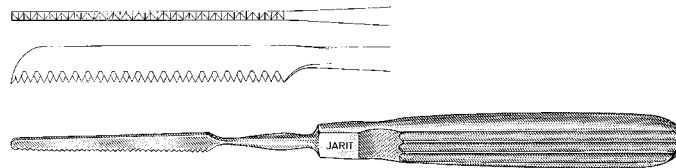

**Stardust Diamond Rasps**

7½" (190mm), 7mm x 25mm blade

Catalog #	Description
420-110	Straight
420-111	Curved

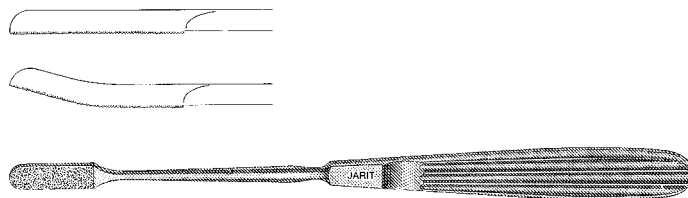

**Converse Rasp**

7" (178mm), double-ended, 11mm x 53mm, cuts on the down stroke

Catalog #	Description
420-120	Fine and coarse ends

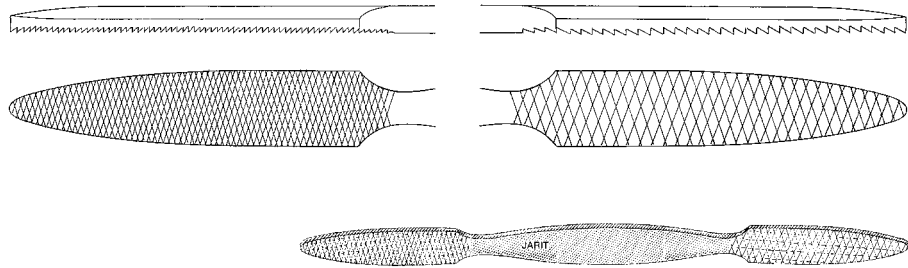

**Fomon Rasps**

8 1/2" (216mm), double-ended, convex and flat sides, 7mm x 35mm, cuts on down stroke

Catalog #	Description
420-125	Fine
420-126	Coarse

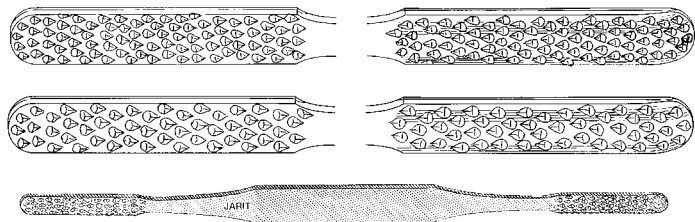

**Cottle Rasp**

8" (204mm), 7.5mm x 36mm, cuts on down stroke

Catalog #	Description
420-130	Fine

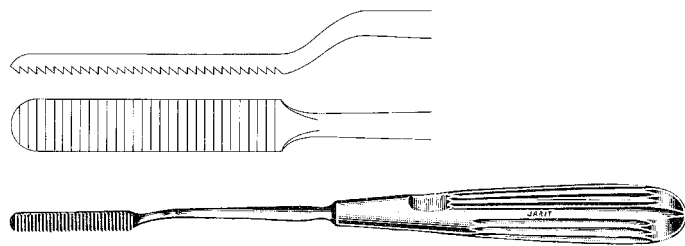

**Fomon Rasp**

8½" (216mm), 7mm x 42mm, double-ended, cuts on down stroke

Catalog #	Description
420-132	Fine and course ends

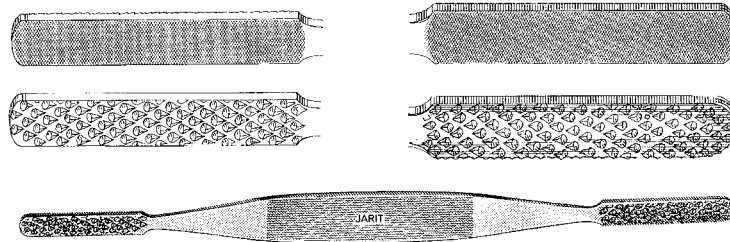

**Maltz Rasp**

6½" (165mm), 8mm x 35mm

Catalog #	Description
420-135	Cuts on down stroke

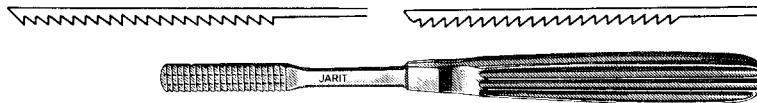

**Maltz-Anderson Rasp**

6½" (165mm), 8mm x 36mm

Catalog #	Description
420-136	Cuts on up stroke

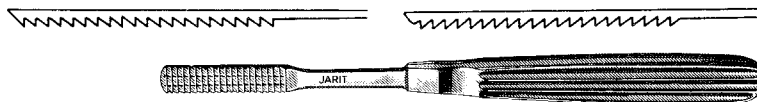

**Parkes Rasps**

8" (203mm), 8.7mm x 32mm, cuts on down stroke

Catalog #	Description
420-138	20 fine concave teeth
420-139	11 extra coarse concave teeth

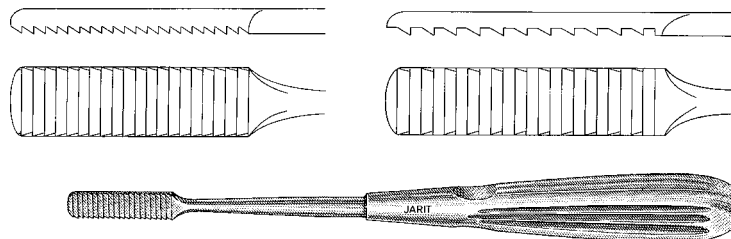

**Aufricht Rasps**

8 1/4" (210mm), 8.5mm x 30mm

Catalog #	Description
420-140	Cuts on up stroke
420-141	Cuts on down stroke

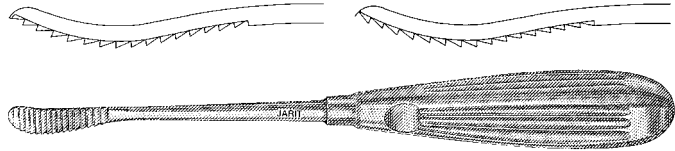

**Lewis Rasp**

7" (180mm), 7.5mm x 15mm

Catalog #	Description
420-145	Cuts on down stroke

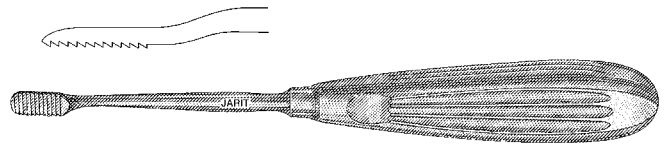

**Joseph Rasp**

cuts on the upstroke, 7" (180mm), 8mm x 40mm

Catalog #	Description
420-147	Coarse teeth

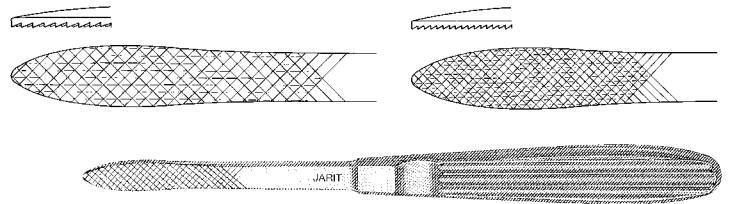

**Joseph Rasp**

cuts on the upstroke, 7 1/4" (184mm), 7.5mm x 40mm

Catalog #	Description
420-148	Fine teeth

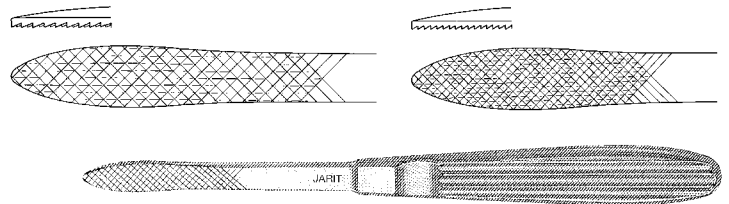



**Kleinert-Kutz Rasp**

8¼" (210mm), double-ended,  
8mm x 47mm convex coarse side and flat fine side

Catalog #	Description
420-150	Cuts on down stroke

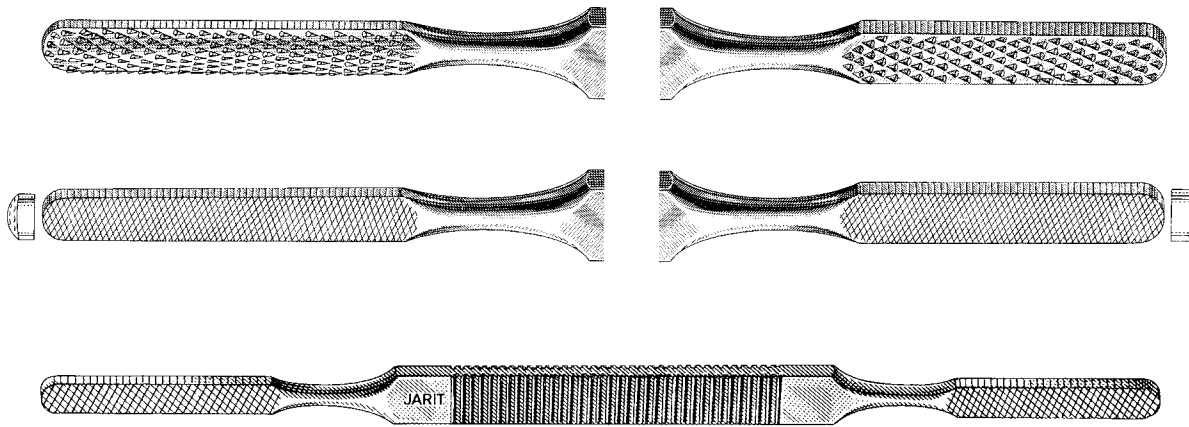

**Wire Brush**

6¼" (160mm), stainless

Catalog #	Description
420-155	For cleaning rasps and files

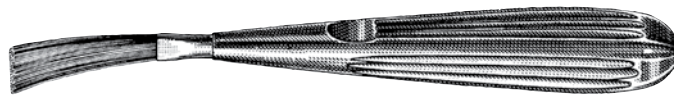

**Dingman Otoabradors**

6⅞" (156mm), double row of 10 fine teeth, 6.3mm long



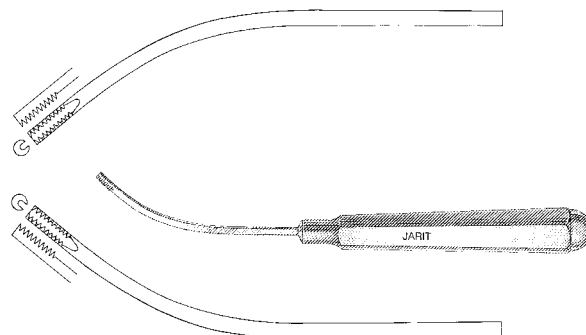

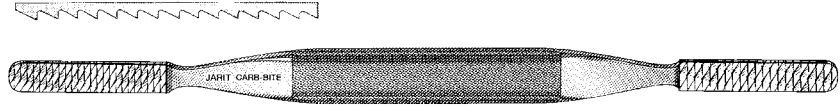
Catalog #	Description
420-160	Curved left
420-161	Curved right



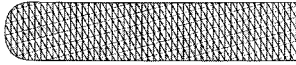
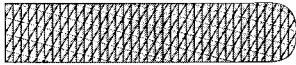

**Nasal Rasps, Double-Ended, Carb-Bite**

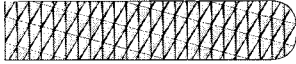
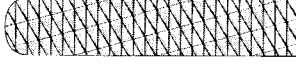
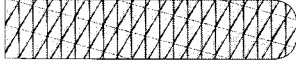
8 1/4" (210mm), double-ended, 7mm x 40mm, cuts on down stroke

Catalog #	Description		Description	
420-170	No. 1: very fine grit		No. 2: fine grit	
420-171	No. 3: fine grit		No. 4: coarse grit	
420-172	No. 5: coarse grit		No. 6: coarse grit	
420-173	No. 7: coarse grit		No. 8: very coarse grit	



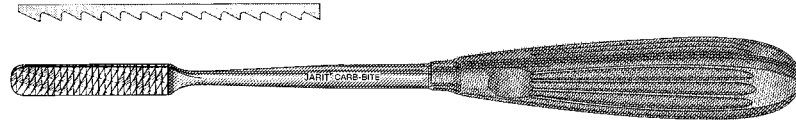

**Nasal Rasps, Single-Ended, Carb-Bite**

8 1/4" (210mm), single-ended, 7mm x 40mm, cuts on down stroke

Catalog #	Description	
420-175	No. 1: very fine grit	
420-176	No. 2: fine grit	
420-177	No. 3: fine grit	
420-178	No. 4: coarse grit	
420-179	No. 5: coarse grit	
420-180	No. 6: coarse grit	
420-181	No. 7: coarse grit	
420-182	No. 8: very coarse grit	

**Glabella Rasp, Carb-Bite**

8¼" (210mm), 5.5mm x 10mm

Catalog #	Description
420-184	Cuts on down stroke

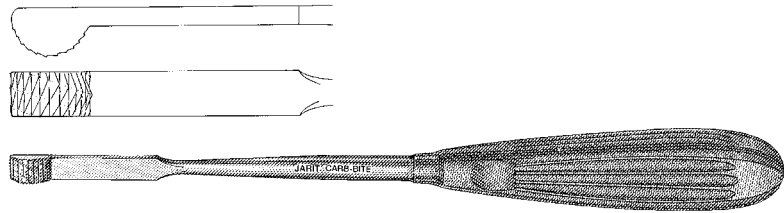

**Cottle Columella Clamp**

4¾" (110mm)

Catalog #	Description
420-210	Jaw width 12mm

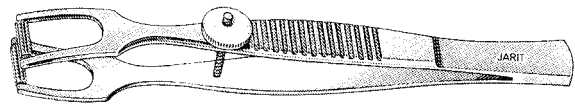

**Integra**<sup>™</sup>  
Post Nasal &  
Sinus Endoscopy  
Instruments and  
General Surgical  
Instruments

**La Force Adenotomes**

8 7/8" (225mm)

Catalog #	Description
430-102	Small size 1: 12mm cut
430-103	Medium size 2: 16mm cut
430-104	Large size 3: 18mm cut

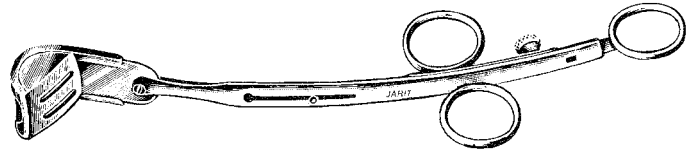

**La Force Adenotome Blades**

Catalog #	Description
430-105	Size 0: 11mm wide blade to fit 0 size Adenotome
430-107	Size 1: 12mm wide blade to fit 430-102
430-108	Size 2: 16mm wide blade to fit 430-103
430-109	Size 3: 18mm wide blade to fit 430-104

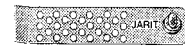

**Shambaugh Adenotomes**

8 1/2" (215mm)

Catalog #	Description
430-120	Small size 1: 12mm cut
430-121	Medium size 2: 16mm cut
430-122	Large size 3: 18mm cut

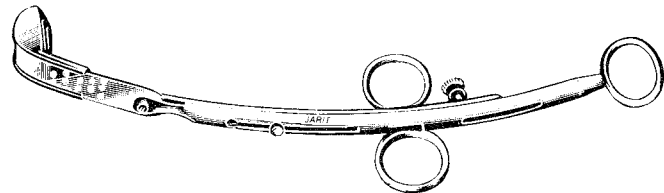

**Shambaugh Adenotome Blades**

Catalog #	Description
430-126	Size 1: 12mm wide blade to fit 430-120
430-127	Size 2: 16mm wide blade to fit 430-121
430-128	Size 3: 18mm wide blade to fit 430-122

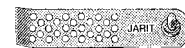

**Jones Adenoid Curettes**

Catalog #	Description
430-135	Infant size: 4mm cutting edge, 8 3/8" (213mm)
430-136	Child size: 6mm cutting edge, 8 3/4" (225mm)
430-137	Adult size: 8mm cutting edge, 8 3/4" (225mm)

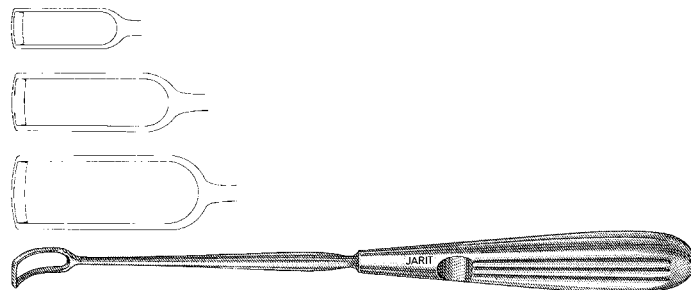

**Vogel Adenoid Curette**

8 3/8" (213mm)

Catalog #	Description
430-140	7mm cutting edge

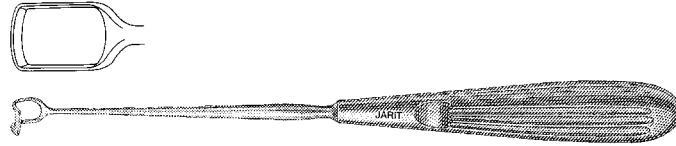

**Barnhill Adenoid Currettes**

8 1/2" (216mm)

Catalog #	Description
430-145	Size 0: 10.5mm cutting edge
430-146	Size 1: 12.5mm cutting edge
430-147	Size 2: 14.5mm cutting edge
430-148	Size 3: 16.5mm cutting edge
430-149	Size 4: 18.5mm cutting edge

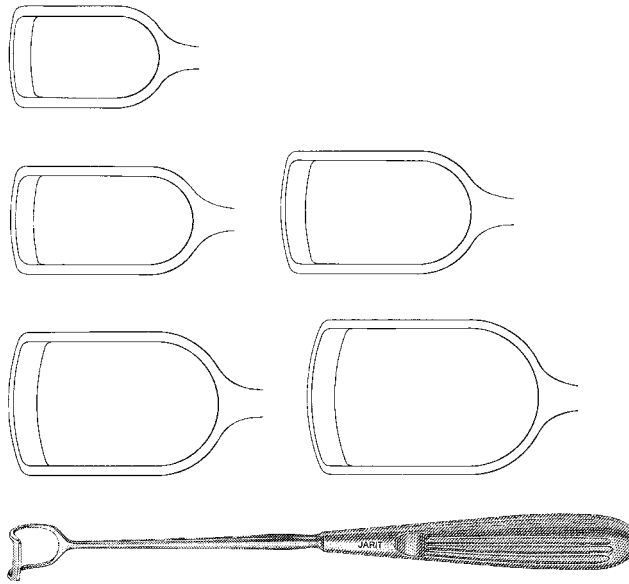

**Middleton Adenoid Curette**

9" (228mm)

Catalog #	Description
430-150	7.5mm cutting edge

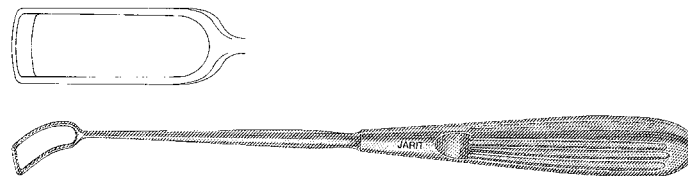

**Stubbs Adenoid Currettes**

8 1/2" (219mm)

Catalog #	Description
430-155	Size 0: 10mm cutting edge
430-156	Size 1: 12mm cutting edge
430-157	Size 2: 14mm cutting edge

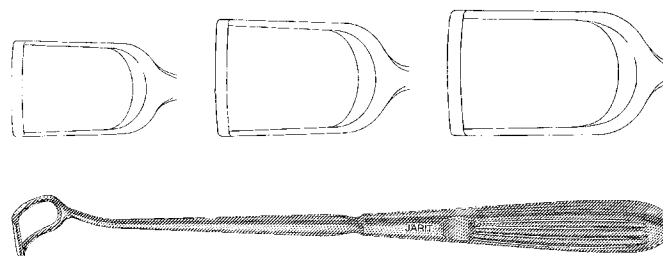

**Reverse Curve Adenoid Curettes**

8 1/2" (216mm)

Catalog #	Description
430-160	Size 0: 10.5mm cutting edge
430-161	Size 1: 12.5mm cutting edge
430-162	Size 2: 14.5mm cutting edge
430-163	Size 3: 16.5mm cutting edge
430-164	Size 4: 18.5mm cutting edge

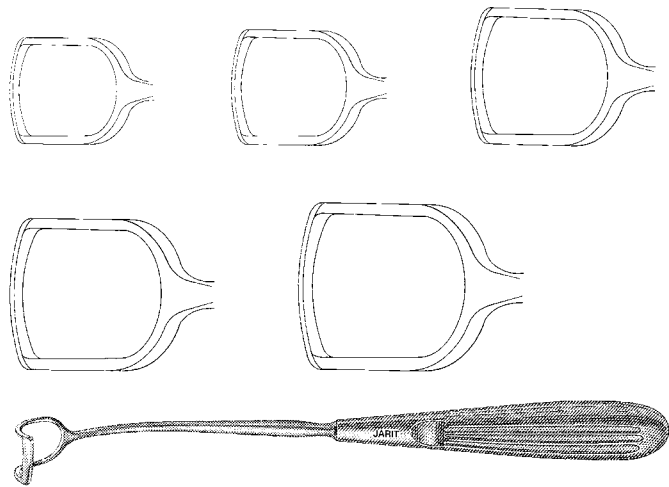

**Hartman (Meltzer) Adenoid Punches**

5 1/2" (140mm) working length, round

Catalog #	Description
430-200	No. 0: 7mm bite
430-201	No. 1: 8mm bite
430-202	No. 2: 9mm bite

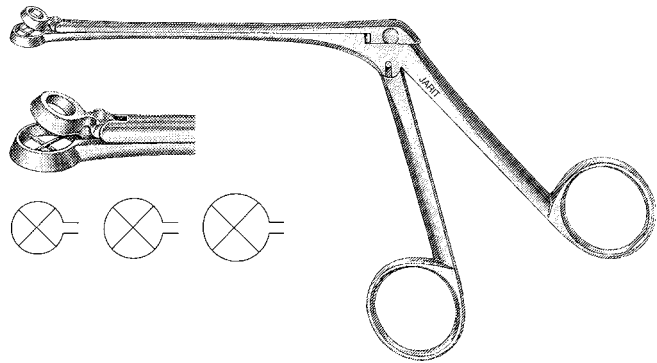

**Schmeden (Meltzer) Adenoid Punches**

5 1/2" (140mm) working length, triangular

Catalog #	Description
430-210	No. 0: 6mm bite
430-211	No. 1: 7mm bite
430-212	No. 2: 8mm bite

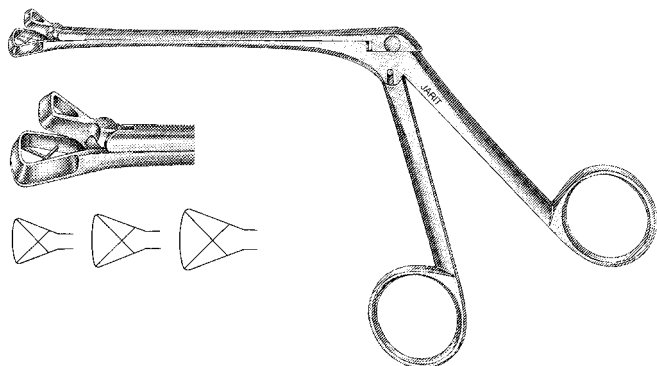



**Ronis Adenoid Punches**

5 1/8" (130mm) working length, up-curved, triangular

Catalog #	Description
430-220	No. 0: 6mm bite
430-221	No. 1: 7mm bite
430-222	No. 2: 8mm bite

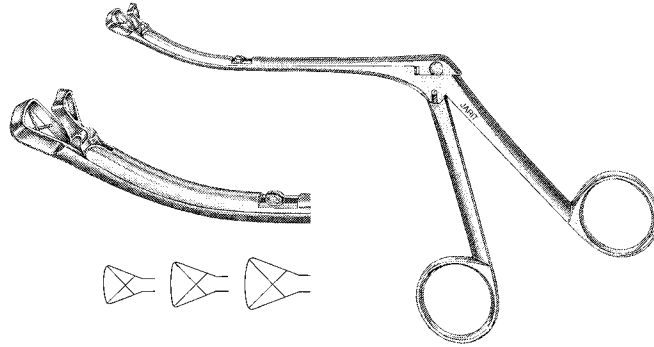

**King Adenoid Punch**

4 1/2" (115mm) working length, down-curved, triangular

Catalog #	Description
430-225	No. 1: 7mm bite

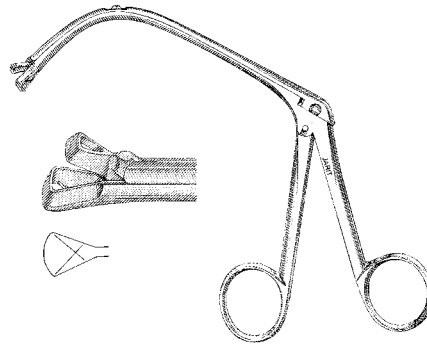

**Love Uvula Retractors**

4 1/8" (104mm) handle, 3 7/8" (97mm) working length

Catalog #	Description
430-240	18mm wide blade
430-241	20mm wide blade
430-242	22mm wide blade

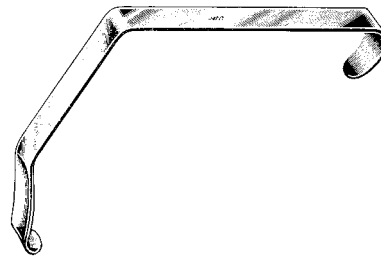

**Lothrop Uvula Retractor**

5 1/4" (133mm) working length

Catalog #	Description
430-245	17mm x 20mm blade

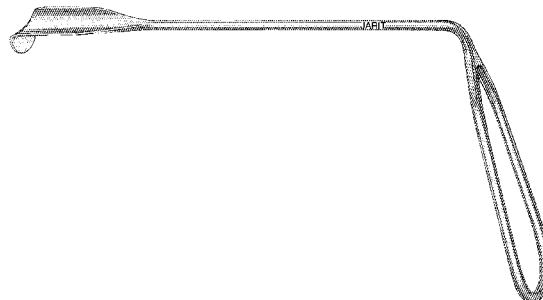

**Freer Double-ended Elevators**

7¾" (198mm), sharp-blunt blades

Catalog #	Description
285-379	6.5mm wide blades
285-380	4.5mm wide blades

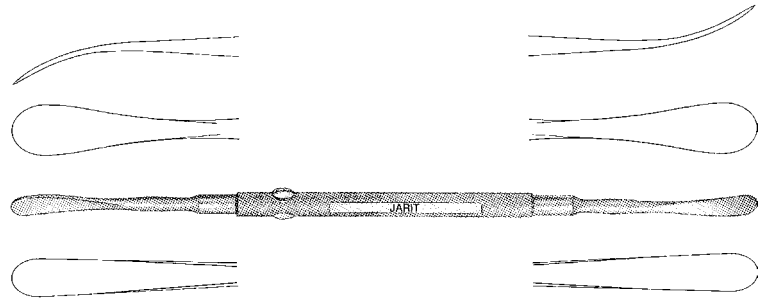

**Frazier Suction Tubes**

7½" (193mm), angular,  
working length 4" (102mm)

Catalog #	Description
285-449	5 French
285-450	6 French
285-451	7 French
285-452	8 French
285-453	9 French
285-454	10 French
285-455	11 French
285-456	12 French
285-457	14 French
285-458	15 French

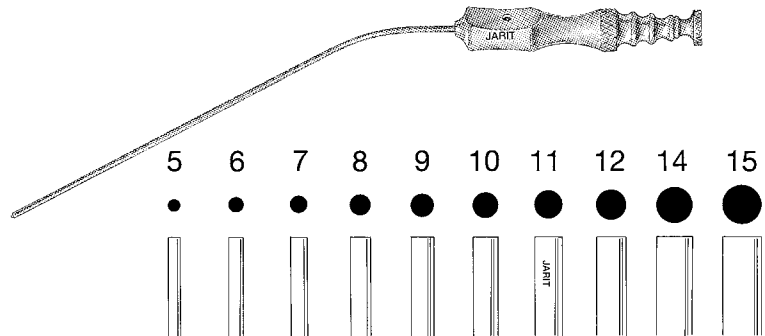

\*For stylets (angled Frazier Suction Tube only)  
add the letter "S" to catalog number.

**Tiek-Halle Infant Nasal Speculum**

Catalog #	Description
400-110	5½" (130mm), 17mm blades

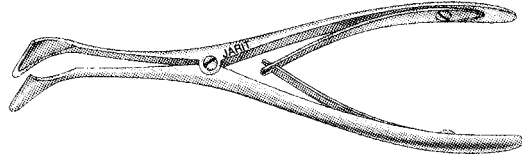
**Killian Septum Specula**

Catalog #	Description
400-130	5¾" (136mm), 50mm blades
400-131	5¾" (145mm), 65.5mm blades
400-132	5¾" (148mm), 76.5mm blades
400-134	6" (153mm), 91mm blades

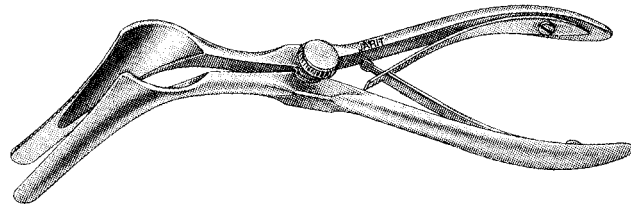
**Hartman Nasal Speculum**

Catalog #	Description
400-135	6¼" (160mm), 33.5mm blades

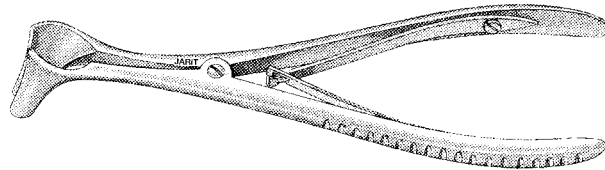
**Cottle Septum Speculum**

Catalog #	Description
400-136	5½" (140mm), 50mm thin blades, tapered to 3.4mm wide

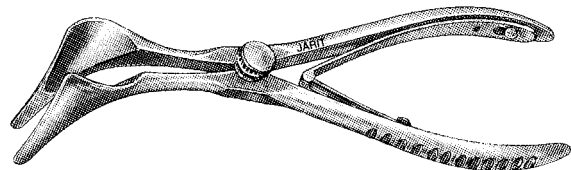
**Knight Nasal Scissors**

Catalog #	Description
400-180	6¾" (171mm), 30mm blades

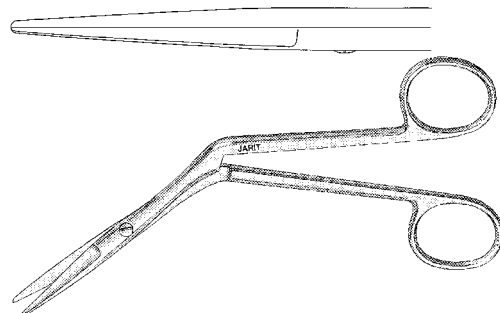

**Knight Nasal Scissors, Supercut**

Catalog #	Description
102-180	6 3/4" (171mm), 30mm blades

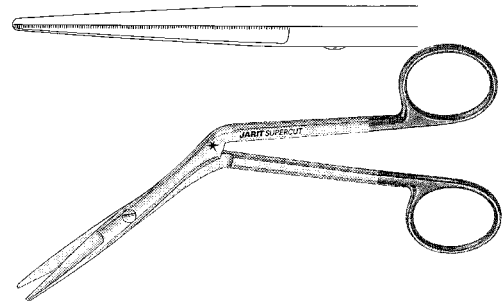

**Ostium Seeker Ball End Elevator**

Catalog #	Description
400-273	7 1/2" (190mm), double-ended, 2.0mm and 2.5mm diameter ball tips



**Cottle Septum Elevator**

Catalog #	Description
400-277	9" (229mm), double-ended, graduated, 4.9mm wide blade and 4.6mm wide round end

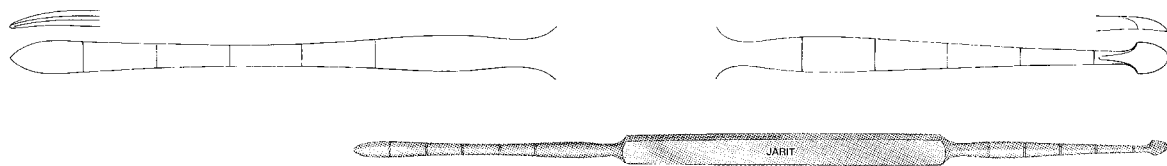

**Coakley Curettes**

7 1/2" (190mm), 7mm x 10mm

Catalog #	Description
400-307	Backward cutting
400-308	Forward cutting

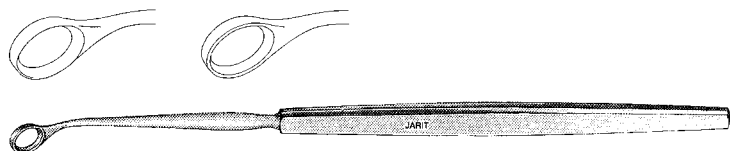

### Blakesley Forceps

4½" (115mm) working length, fenestrated jaws

Catalog #	Description
440-110	Straight, size 0, 3.5mm jaw width
440-114	Straight, size 1, 4mm jaw width
440-118	Straight, size 2, 5mm jaw width

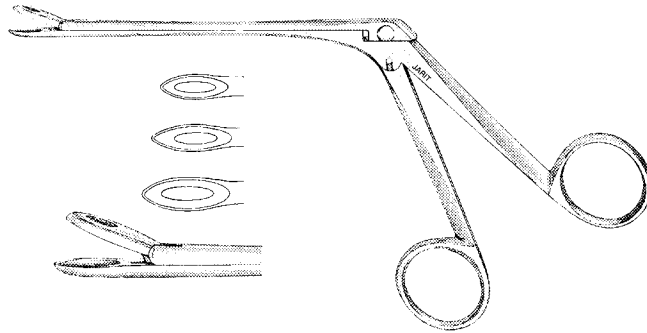

### Blakesley Forceps

4½" (115mm) working length, fenestrated jaws

Catalog #	Description
440-130	Up-angled, 45°, size 0, 3.5mm jaw width
440-134	Up-angled, 45°, size 1, 4mm jaw width
440-138	Up-angled, 90°, size 0, 3.5mm jaw width
440-140	Up-angled, 90°, size 1, 4mm jaw width

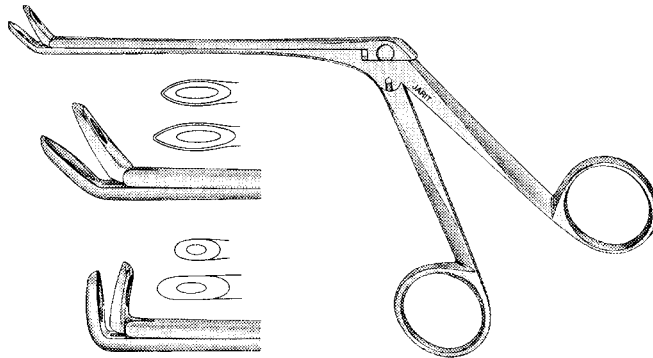

### Struempel Pediatric Forceps

4⅞" (105mm) working length, fenestrated jaws, 2.4mm jaw width

Catalog #	Description
440-150	Straight
440-154	Up-angled 45°
440-158	Up-angled 90°

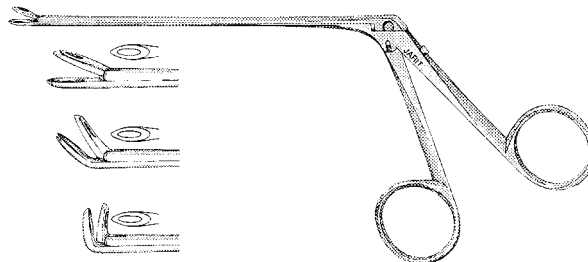

### Blakesley Thru-Cutting Forceps

4 1/2" (115mm) working length

Catalog #	Description
440-160	Straight, size 0, 3.5mm jaw width
440-161	Straight, size 1, 4mm jaw width
440-162	Up-angled 45°, size 0, 3.5mm jaw width
440-163	Up-angled 45°, size 1, 4mm jaw width
440-164	Angled right, size 0, 3.5mm jaw width
440-165	Angled left, size 0, 3.5mm jaw width

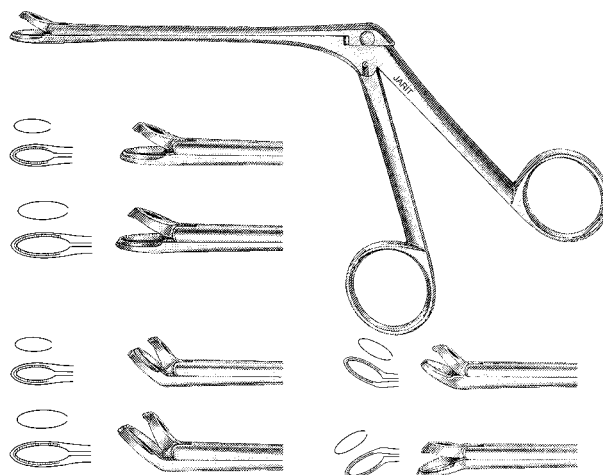

### Blakesley Pediatric Thru-Cutting Forceps

4 1/2" (115mm) working length,  
size 00, 2.5mm jaw width

Catalog #	Description
440-166	Straight
440-167	Up-angled 45°

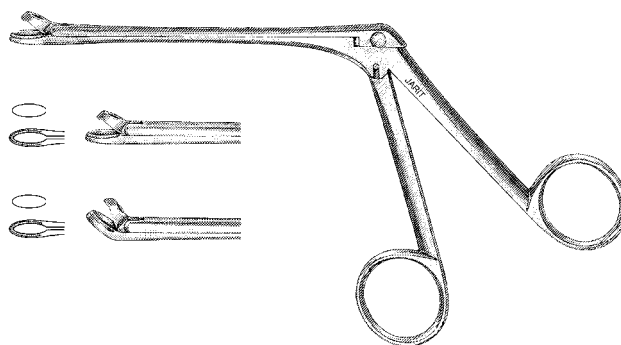

### Blakesley Suction Forceps

4" (100mm) working length,  
fenestrated jaws

Catalog #	Description
440-174	Straight, size 0, 3.5mm jaw width
440-178	Straight, size 1, 4mm jaw width
440-184	Up-angled, size 0, 3.5mm jaw width
440-186	Up-angled, size 1, 4mm jaw width
440-532	Cleaning Brush 8" (205mm), 27mm x 3.5mm, package of 6

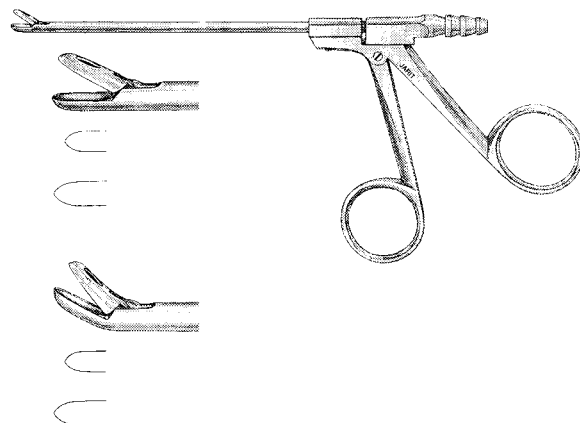

**Blakesley Pediatric Suction Forceps**

4" (100mm) working length,  
size 00, 2.5mm wide fenestrated jaws

Catalog #	Description
440-170	Straight
440-182	Up-angled
440-532	Cleaning Brush 8" (205mm), 27mm x 3.5mm, package of 6

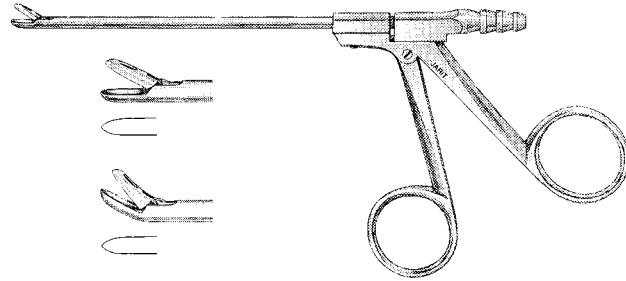

**Nasal Alligator Scissors**

4½" (115mm) working length,  
tapered 11mm blades

Catalog #	Description
440-200	Straight
440-202	Right
440-204	Left

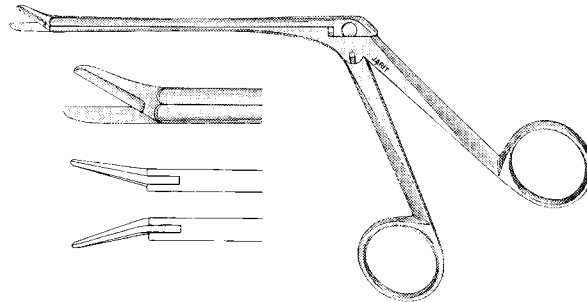

**Struycken Nasal Cutting Forceps**

Catalog #	Description
440-208	4½" (115mm) working length, 1mm bite

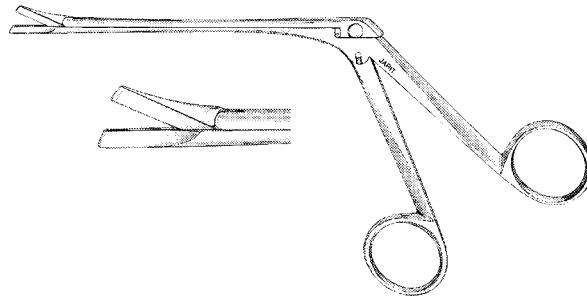

**Takahashi Forceps**

4½" (115mm) working length

Catalog #	Description
440-300	Straight, 2.5mm bite
440-304	Straight, 4mm bite
440-306	Up-angled, 2.5mm bite

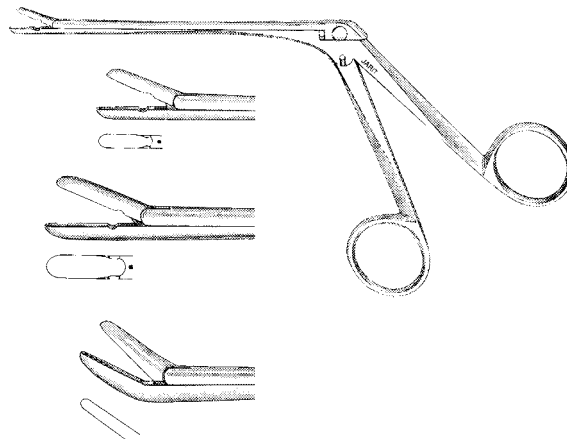

**Takahashi Suction Forceps**

Catalog #	Description
440-308	4" (100mm) working length, straight 3.5mm jaw width
440-532	Cleaning Brush, 8" (205mm), 27mm x 3.5mm, package of 6

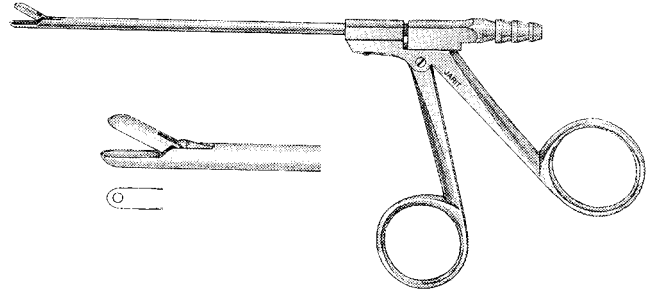

**Giraffe Frontal Sinus Forceps w/luer lock port**

5 1/8" (130mm) working length, double-action 3mm jaw width

Catalog #	Description
440-310	Straight
440-312	70°, vertical
440-314	70°, horizontal
440-316	110°, vertical
440-318	110°, horizontal

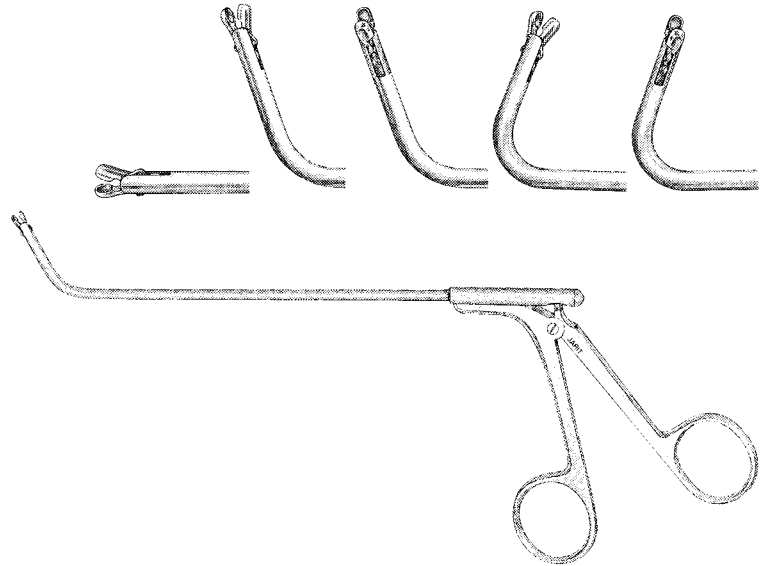



### Hajek-Koffler Punches

5½" (140mm) working length, 4mm bite, 8.5mm opening

Catalog #	Description
440-340	Upward cutting, 90°
440-342	Downward cutting, 90°
440-344	Forward cutting, 45°
440-346	Backward cutting, 45°

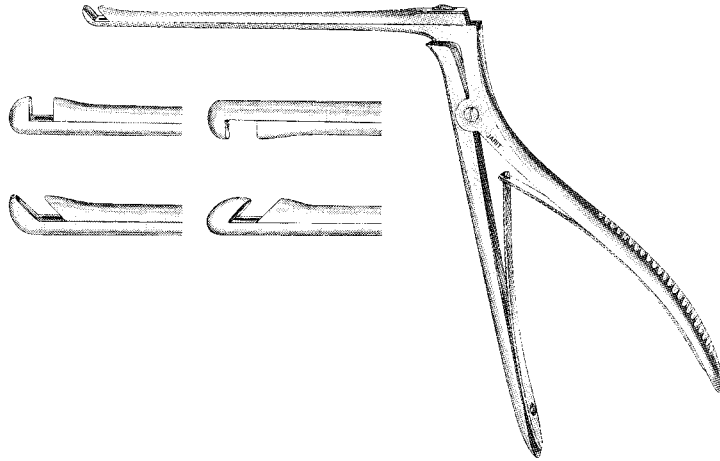

### Hajek-Koffler Punch

Catalog #	Description
440-348	4⅞" (106mm) working length, rotatable, 3mm bite, 6.5mm opening

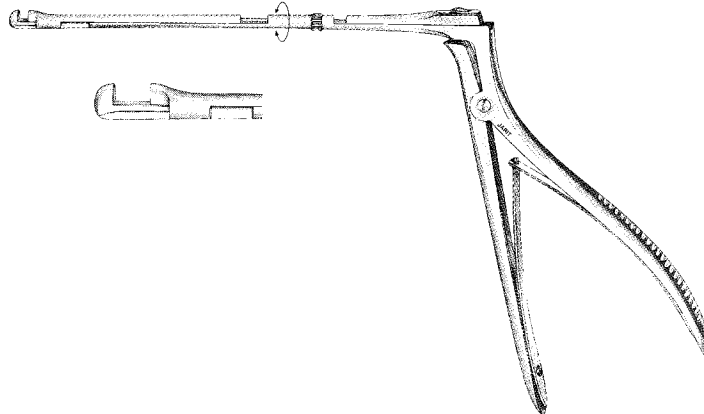

### McKenty Punch

Catalog #	Description
440-350	3⅜" (85mm) working length, rotatable, 2mm bite, 5.5mm opening

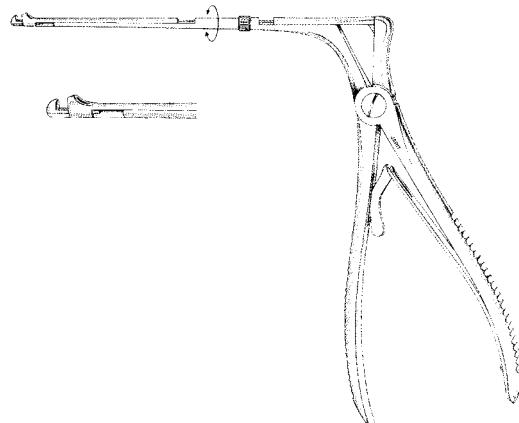

### Ostrum Antrum Suction Punches

4" (102mm) working length, 2.5mm bite, backward cutting

Catalog #	Description
440-360	Straight
440-364	Right
440-368	Left
440-532	Cleaning Brush, 8" (205mm), 27mm x 3.5mm, package of 6

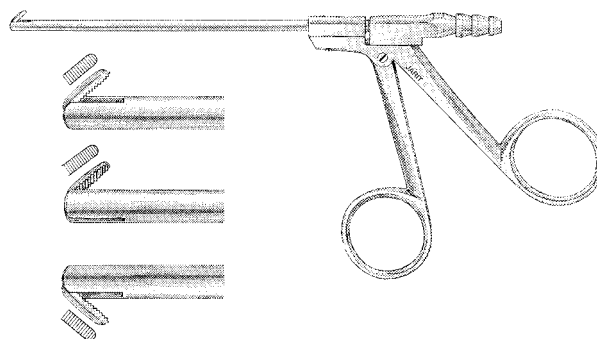

### Ostrum Antrum Punch

Catalog #	Description
440-370	4½" (115mm) working length, rotatable, adult, 2.5mm bite, backward cutting

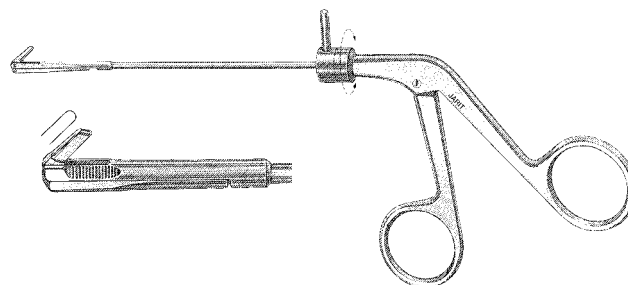

### Ostrum Antrum Pediatric Suction Punches

4" (102mm) working length, 2mm bite, backward cutting

Catalog #	Description
440-372	Straight
440-376	Right
440-378	Left
440-532	Cleaning Brush, 8" (205mm), 27mm x 3.5mm, package of 6

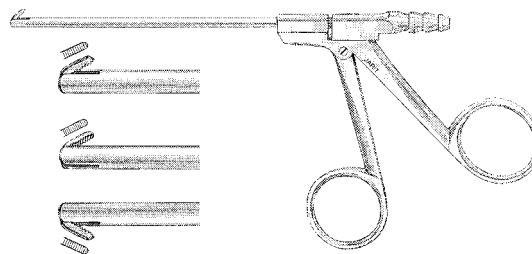

### Ostrum Antrum Pediatric Punch

Catalog #	Description
440-380	4½" (115mm) working length, rotatable, 1.5mm bite, backward cutting

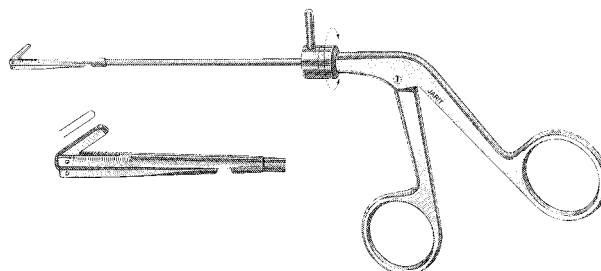

## Von Eicken Suction Cannulas

5<sup>3</sup>/<sub>4</sub>" (146mm)

Catalog #	Description
440-390	Curved long, 3mm
440-394	Curved short, 3mm
440-398	Curved short, 4mm
440-530	Cleaning Brush, 8" (205mm), 27mm x 3.5mm, package of 6

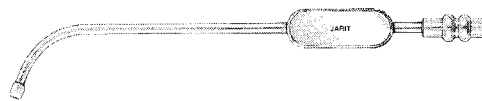

## Antrum Curettes

oblong

Catalog #	Description
440-400	7 <sup>1</sup> / <sub>2</sub> " (190mm), 2mm x 5mm cup
440-402	7 <sup>1</sup> / <sub>2</sub> " (190mm), 3.7mm x 9.5mm cup
440-404	7 <sup>1</sup> / <sub>2</sub> " (190mm), 7mm x 11mm cup
440-406	7 <sup>1</sup> / <sub>2</sub> " (190mm), 8mm x 11mm cup
440-407	7 <sup>1</sup> / <sub>2</sub> " (190mm), 2mm x 5mm cup, 45°
440-408	7" (180mm), 2.5mm x 5mm cup, 90°

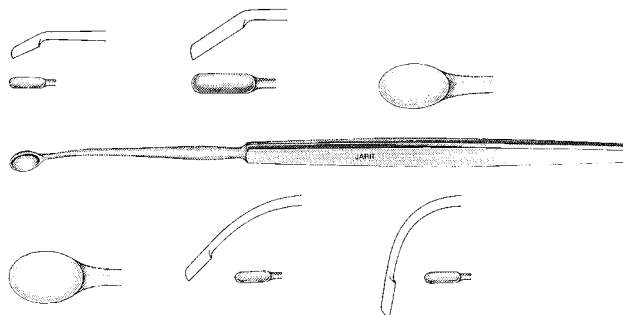

## Sinus Sickle Knives

7<sup>1</sup>/<sub>2</sub>" (193mm)

Catalog #	Description
440-410	Pointed tip: 11mm blade
440-412	Blunt tip: 10.5mm blade



## Sinus Septum Needle

Catalog #	Description
440-416	5 <sup>1</sup> / <sub>8</sub> " (130mm) overall length, angled, 23 gauge, 1/2" (14mm) needle length

440-CAP-416 Replacement Protective Cap

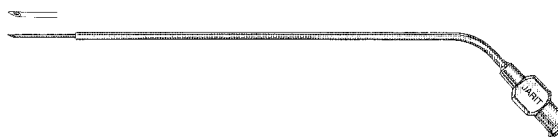

## Frontal Ostium Seeker

Catalog #	Description
440-420	8" (203mm), double-ended, one end 90° to shaft

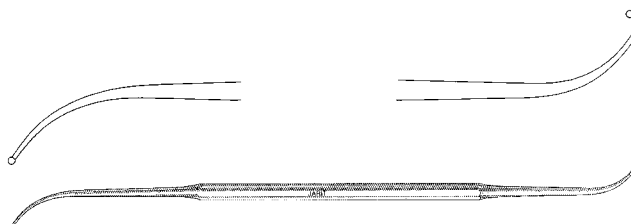

### Sinoscopy Trocar and Cannula

Catalog #	Description
440-430	Cannula 3 <sup>1</sup> / <sub>4</sub> " (83mm), Trocar 6 <sup>1</sup> / <sub>2</sub> " (165mm), 5mm wide

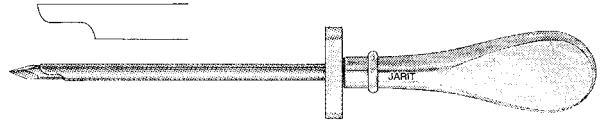

### Tray for Sinuscope

Catalog #	Description
440-510	6" x 15 <sup>1</sup> / <sub>4</sub> " x 3 <sup>1</sup> / <sub>2</sub> " (152mm x 390mm x 90mm), holds two sinuscopes

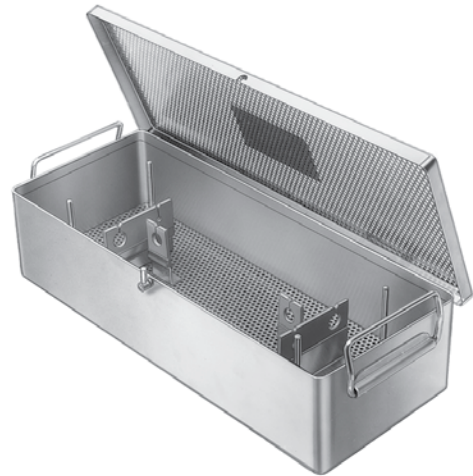

### Sinuscopes, Autoclavable

6<sup>7</sup>/<sub>8</sub>" (175mm) working length

Catalog #	Description
440-700	4mm, 0°
440-730	4mm, 30°
440-770	4mm, 70°
440-720	2.7mm, 0°
440-740	2.7mm, 30°

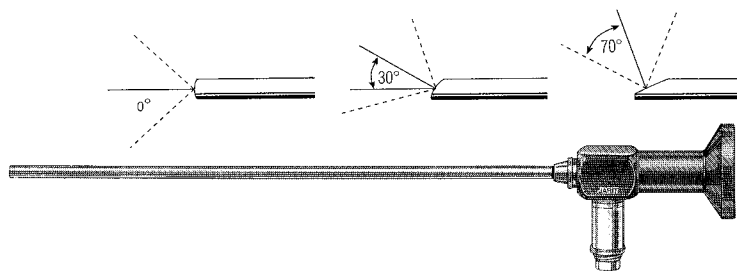

**Integra**<sup>™</sup>  
Throat & Laryngeal  
Instruments and  
General Surgical  
Instruments

### Dingman Mouth Gag

Catalog #	Description
450-090	Complete with 3 tongue blades

### Dingman Tongue Blades

Catalog #	Description
450-091	Small blade: 25mm wide x 62mm deep x 136mm long
450-092	Medium blade: 29mm wide x 65mm deep x 136mm long
450-093	Large blade: 32mm wide x 75mm deep x 136mm long
450-FRM-090	Replacement Frame (70mm x 144mm)
450-WSR-090	Replacement Washer for Side Blade
450-BLD-090	Replacement Side Blade
450-SBA-090	Replacement Side Blade Attachment
450-SRW-090	Replacement Screws Pkg/8ea

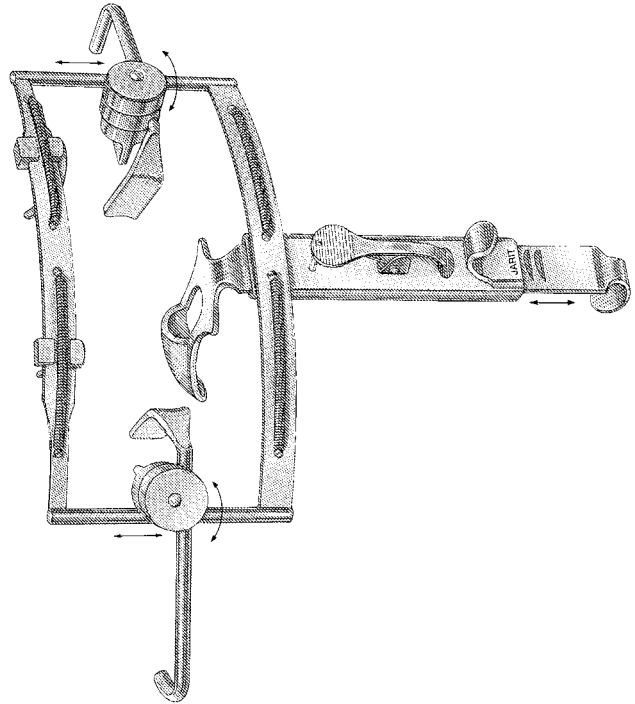

### Jennings Mouth Gags

Catalog #	Description
450-100	Infant size: 3½" (90mm), 41mm spread
450-101	Small size: 4¾" (110mm), 38mm spread
450-102	Medium size: 5⅛" (130mm), 46mm spread
450-103	Large size: 5½" (140mm), 50mm spread

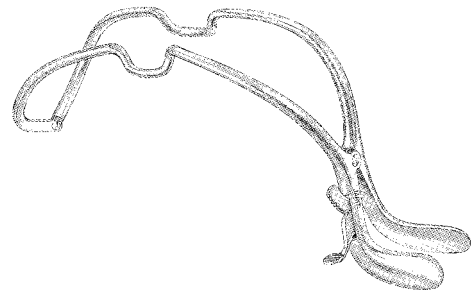

### Sluder-Jansen Mouth Gags

Catalog #	Description
450-105	Child size: 4¾" (110mm), 35mm spread
450-106	Adult size: 5¾" (135mm), 50mm spread
450-SC-105	Replacement Silicone Blade Guard (Latex Free) pkg/6ea
450-SC-106	Replacement Silicone Blade Guard (Latex Free) pkg/6ea

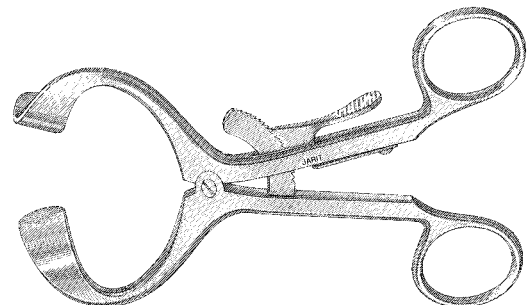

### Davis Mouth Gag Frames

6" (151mm) overall length

Catalog #	Description
450-110	Double bite left side
450-111	Double bit right side
450-112	Single bite left side
450-113	Single bite right side
450-110RI	Replacement insert (Latex Free) pkg/12ea

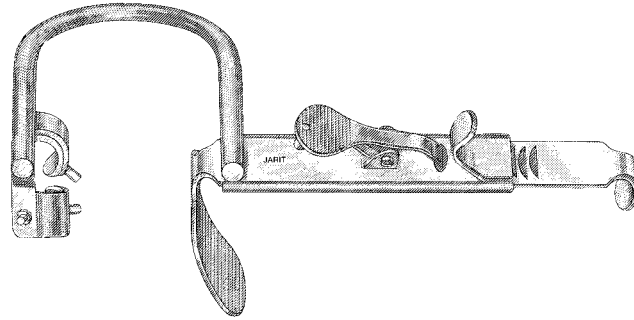

### Davis Mouth Gag Blades

5<sup>3</sup>/<sub>8</sub>" (136mm)

Catalog #	Description
450-120	Size 1: 1" x 3/4" (25mm x 19mm)
450-121	Size 1½: 1½" x 7/8" (38mm x 21mm)
450-122	Size 2: 2¼" x 7/8" (57mm x 22mm)
450-123	Size 2½: 2½" x 7/8" (65mm x 23mm)
450-124	Size 3: 2¾" x 7/8" (70mm x 23mm)
450-125	Size 3½: 3" x 1" (76mm x 24mm)
450-126	Size 4: 3¼" x 1" (83mm x 24mm)
450-127	Size 4½: 3½" x 1" (90mm x 25mm)
450-128	Size 5: 4" x 1" (101mm x 26mm)

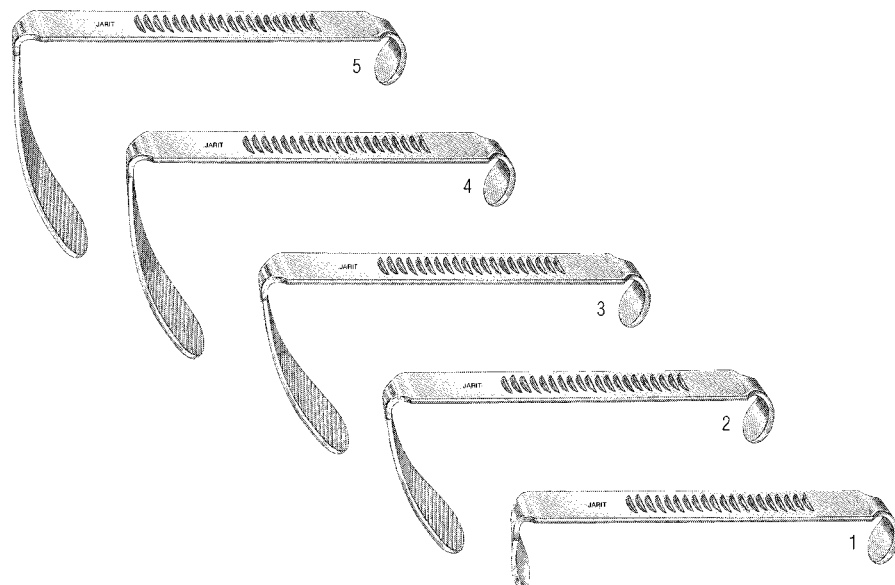

### Mclvor Mouth Gag

Catalog #	Description
450-140	Complete with 3 blades
450-141	Frame only, 5 <sup>3</sup> / <sub>4</sub> " (145mm) x 2 <sup>3</sup> / <sub>8</sub> " x 4" (60mm x 100mm)
450-142	Blade only, size 1: 7 <sup>7</sup> / <sub>8</sub> " x 2 <sup>3</sup> / <sub>4</sub> " (23mm x 70mm)
450-143	Blade only, size 2: 1" x 3 <sup>3</sup> / <sub>8</sub> " (25mm x 86mm)
450-144	Blade only, size 3: 1" x 4" (26mm x 100mm)
450-RS-140	Replacement Shod (Latex Free) pkg/12ea
450-FRS-140	Replacement Frame Release Screw pkg/6ea
450-WLP-141	Replacement Wire Loop

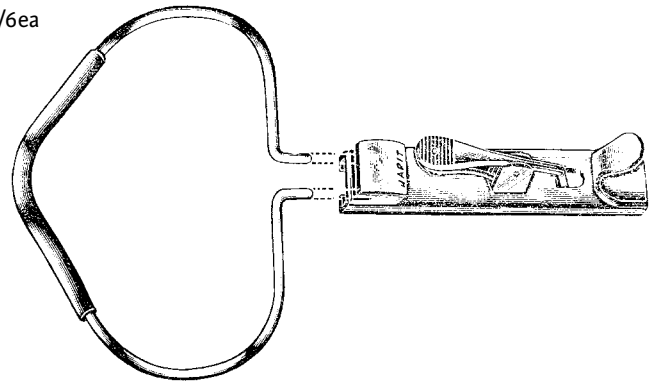

### Cheek Retractor

Catalog #	Description
450-145	8" (201mm), 31.5mm swivel blade

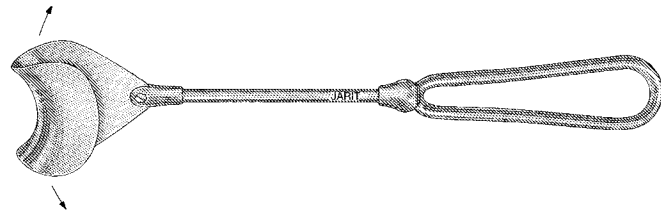

### Sewall Orbital Retractors

6<sup>1</sup>/<sub>4</sub>" (160mm)

Catalog #	Description
450-146	7mm x 52mm blade
450-147	9mm x 51mm blade
450-148	11mm x 50mm blade
450-149	13mm x 67mm blade

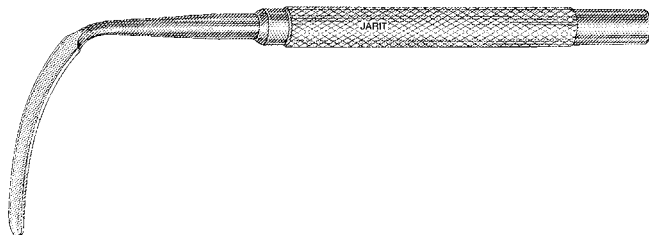



### Wieder Tongue Depressors

5" (126mm)

Catalog #	Description
450-150	Small: 28mm blade, serrated
450-151	Large: 36mm blade, serrated

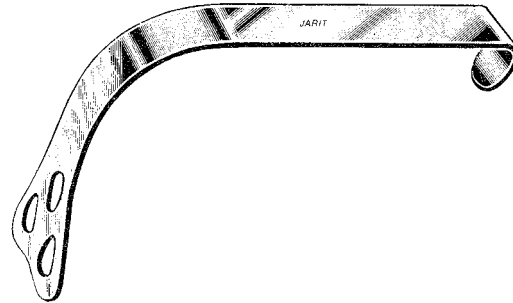

### Andrew Tongue Depressor

4 1/8" (105mm)

Catalog #	Description
450-155	20mm blade, serrated

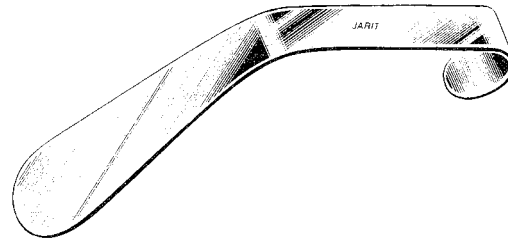

### Ring Retractor Blades

6" (155mm)

for Davis or McIvor frames

Catalog #	Description
450-160	Size 2: right, 7/8" x 2 1/4" (23mm x 57mm)
450-161	Size 3: right, 1 1/8" x 2 7/8" (27mm x 72mm)
450-162	Size 4: right, 1 1/4" x 3 1/2" (33mm x 88mm)
450-166	Size 5: right, 1 1/2" x 3 3/4" (38mm x 95mm)
450-163	Size 2: left, 7/8" x 2 1/4" (23mm x 57mm)
450-164	Size 3: left, 1 1/8" x 2 7/8" (27mm x 72mm)
450-165	Size 4: left, 1 1/4" x 3 1/2" (33mm x 88mm)
450-167	Size 5: left, 1 1/2" x 3 3/4" (38mm x 95mm)

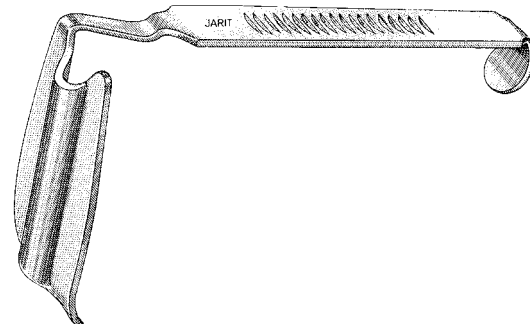

**Colver Tonsil Seizing Forceps**

7½" (190mm)

Catalog #	Description
450-200	Straight, 5.6mm jaws
450-201	Curved, 6mm jaws

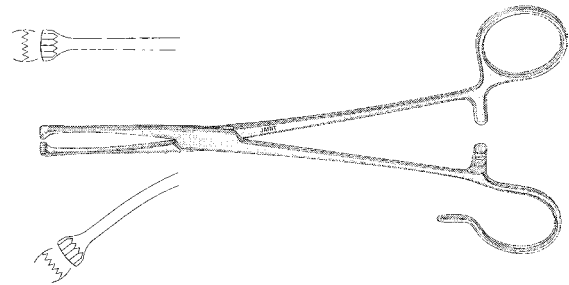

**White Tonsil Seizing Forceps**

curved

Catalog #	Description
450-205	9½" (240mm), 7.5mm jaws
450-210	7¼" (182mm), 6mm jaws

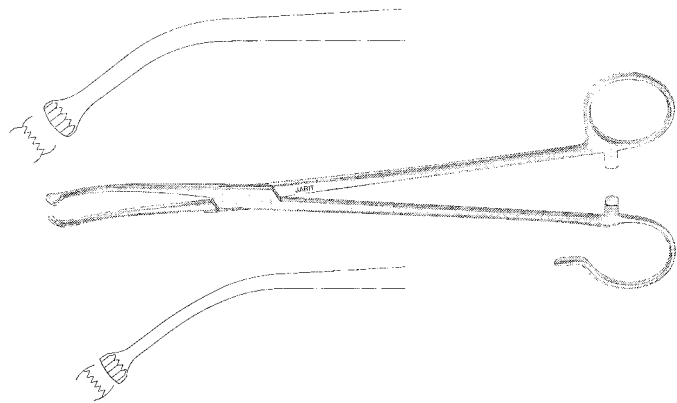

**Ballenger Tonsil Seizing Forceps**

8½" (217mm)

Catalog #	Description
450-220	3 x 3 teeth, (9mm wide)

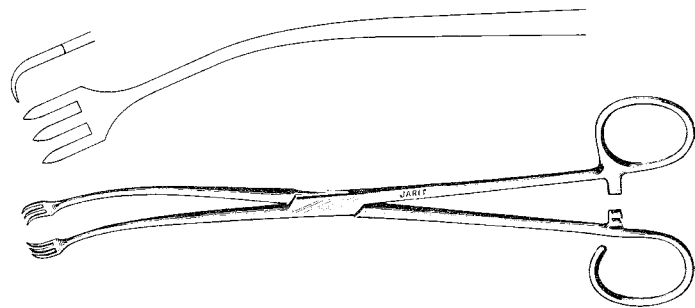

**Tivnen Tonsil Seizing Forceps**

7¾" (200mm)

Catalog #	Description
450-222	3 x 3 teeth, (7mm wide)

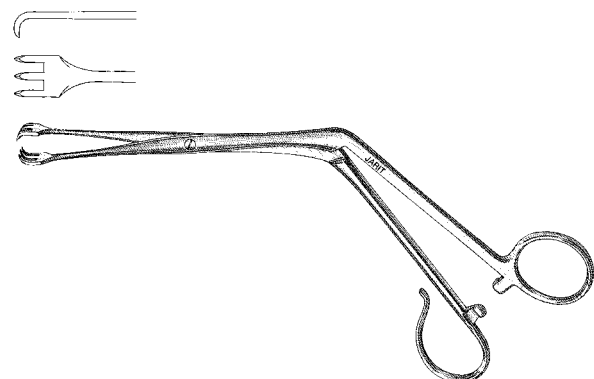

**Schmidt Tonsil Forceps, (Mirror Finish)**

7½" (190mm)

Manufactured from high grade German surgical stainless steel which is ground and polished to a mirror finish

Catalog #	Description
450-300	Half curved, one open ring
450-301	Full curved, one open ring
450-310	Half curved, closed rings
450-311	Full curved, closed rings



**Schmidt Tonsil Forceps, (Matte Finish)**

7½" (190mm)

Manufactured from high grade German surgical stainless steel which is glass beaded to a matte finish

Catalog #	Description
449-310	Half curved, closed rings

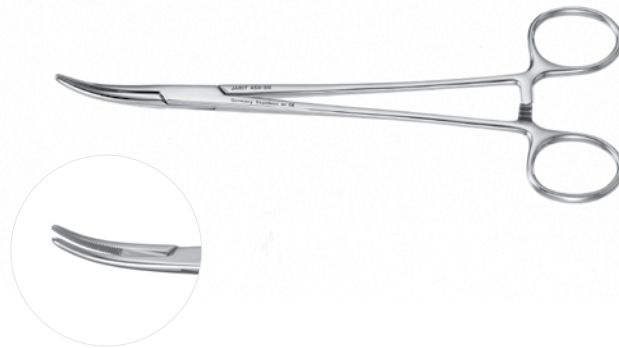

**Hurd Dissector and Pillar Retractors**

8¾" (224mm)

Catalog #	Description
450-399	Small: 7mm dissector, 12mm retractor
450-400	Large: 9mm dissector, 13mm retractor
450-401	Large: 9.6mm dissector, 13.3mm retractor, serrated edge

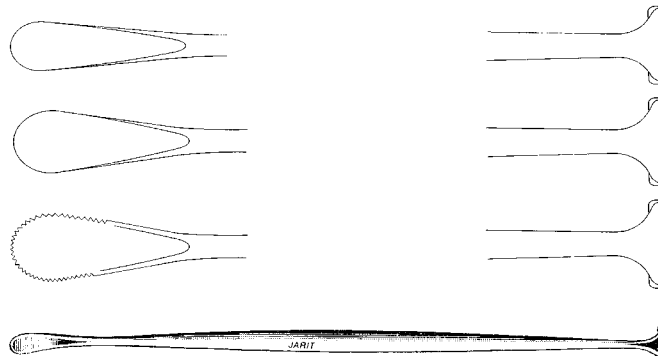

**Dean Tonsil Knife**

8 1/4" (210mm)

Catalog #	Description
450-407	Straight, 25mm blunt double-edged blade



**Lothrop Tonsil Knife and Dissector**

8 3/4" (222mm)

Catalog #	Description
450-412	Double-ended, 25mm bayonet shaped blade and 10mm curved blade

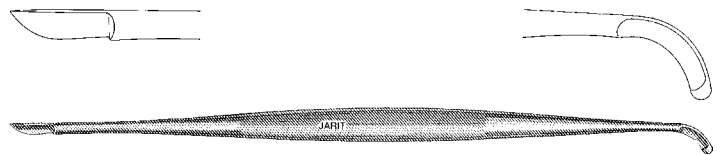

**Fisher Tonsil Knife**

8 1/4" (210mm)

Catalog #	Description
450-415	15mm curved blade, serrated on top, straight distal tip

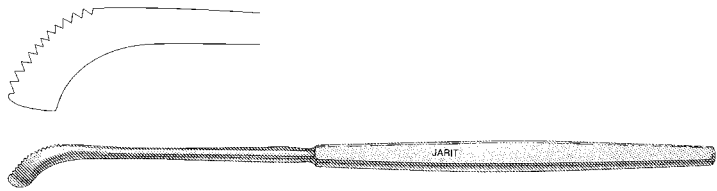

**Colver Tonsil Knife**

8 1/4" (210mm)

Catalog #	Description
450-417	15mm curved blade, serrated on top, rounded distal tip

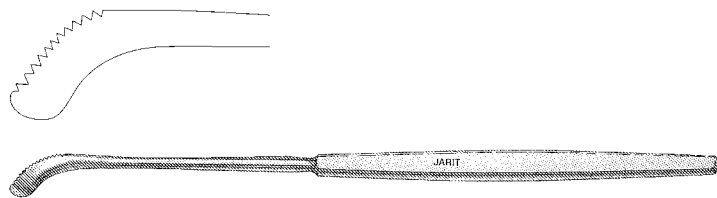

**Robb Tonsil Knife**

8 1/2" (215mm)

Catalog #	Description
450-420	6.5mm x 30mm sickle shaped blade

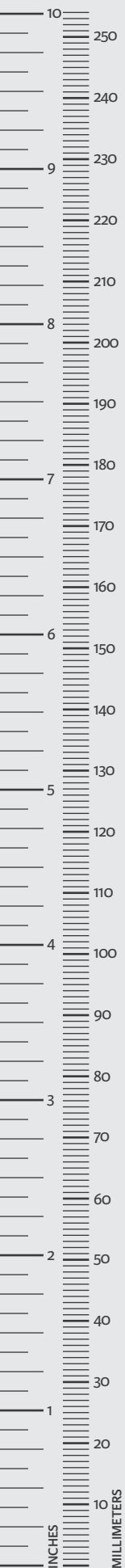
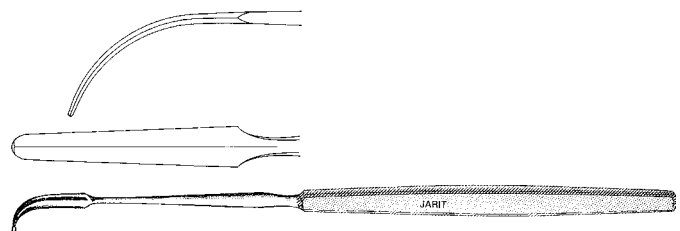

**Dean Tonsil Scissors**

7" (175mm)

Catalog #	Description
450-450	Angled, 20mm blades, bottom blade serrated

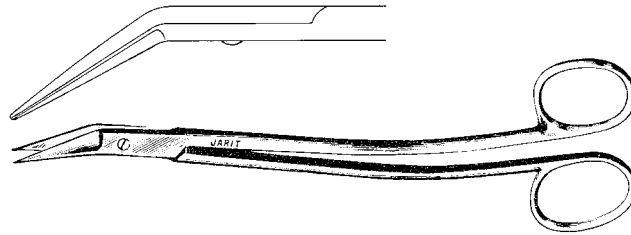

**Boettcher Tonsil Scissors**

7¼" (184mm)

Catalog #	Description
450-455	Curved, 37mm blades, sharp outer edges

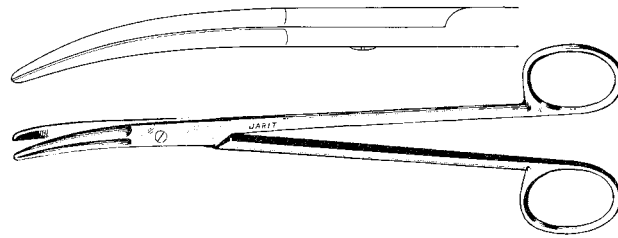

**Lillie Tonsil Scissors**

8" (205mm)

Catalog #	Description
450-457	Curved, 40mm blades

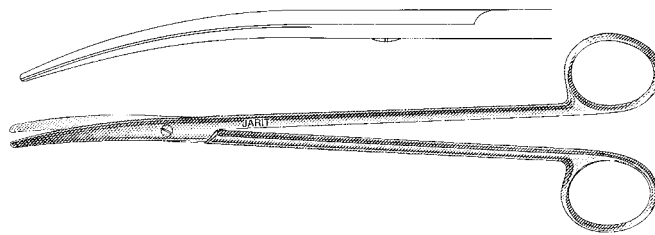

**Boyd Tonsil Scissors**

7" (177mm)

Catalog #	Description
450-460	Double curved, 30mm blades

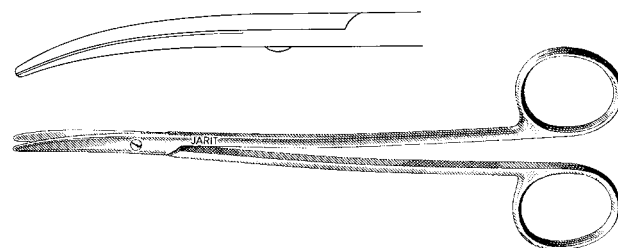

**Metzenbaum Scissors, Curved, (Mirror Finish)**

Manufactured from high grade German surgical stainless steel which is ground and polished to a mirror finish

Catalog #	Description
100-262	7" (178mm), 33mm blades
100-266	8" (206mm), 42mm blades

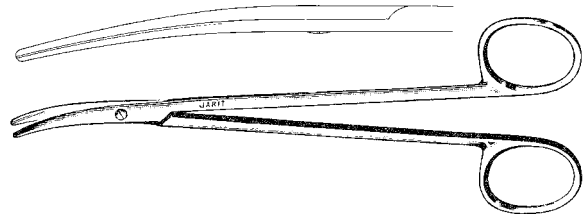

**Metzenbaum Scissors, Curved, (Matte Finish)**

Manufactured from high grade German surgical stainless steel which is glass beaded to a matte finish

Catalog #	Description
099-262	7" (176mm), 33mm blades

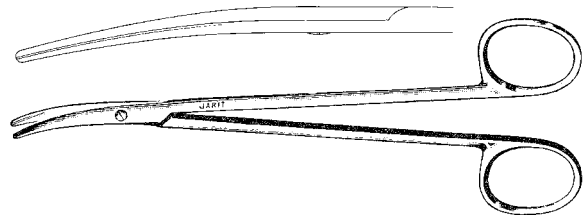

**Metzenbaum Scissors, Carb-Edge, (Satin Finish)**

Manufactured from high grade German surgical stainless steel which is ground and polished to a satin finish

Catalog #	Description
101-258	7" (179mm), curved, 33mm blades
101-265	8" (206mm), curved, 42mm blades

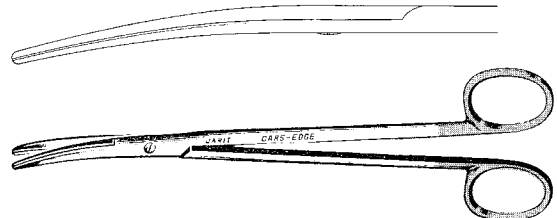

**Metzenbaum Scissors, Carb-Edge, (Matte Finish)**

Manufactured from high grade German surgical stainless steel which is glass beaded to a matte finish

Catalog #	Description
103-258	7" (179mm), curved, 33mm blades

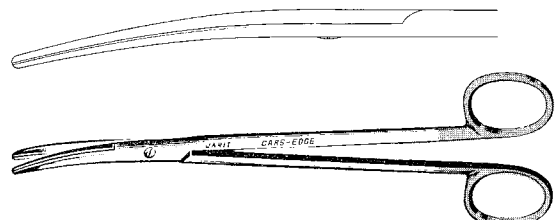

**Metzenbaum Scissors, Supercut curved**

Catalog #	Description
102-122	7" (180mm), 33mm blades

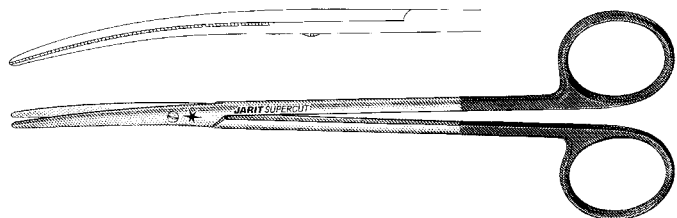

**Eve Tonsil Snare**

11¼" (285mm)

Catalog #	Description
450-500	Plain, includes 1 package of 12 snare wires, 25 gauge

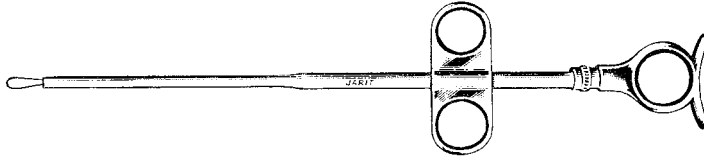

**Eve Tonsil Snare**

11¼" (285mm)

Catalog #	Description
450-501	with Ratchet, includes 1 package of 12 snare wires, 25 gauge

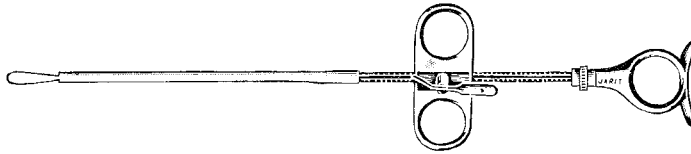

**Sage Tonsil Snare**

9" (230mm)

Catalog #	Description
450-505	Includes 1 package of 12 snare wires, 25 gauge

- 450-DTN-505 Replacement Detachable Nozzle
- 450-STY-505 Replacement Stylet
- 450-SPS-505 Replacement Spring and Screw

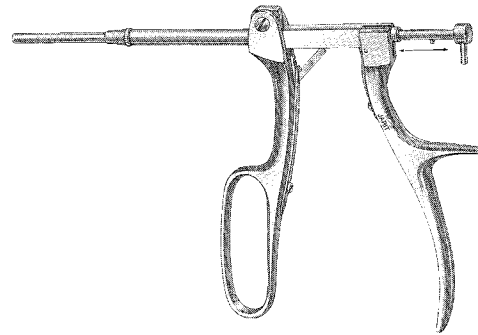

**Tydings Tonsil Snare**

7½" (188mm)

Catalog #	Description
450-510	Includes 1 package of 12 snare wires, 25 gauge

- 450-DTN-505 Replacement Detachable Nozzle
- 450-STY-505 Replacement Stylet
- 450-HTS-510 Replacement Handle Thumb Screw
- 450-ESC-510 Replacement End Screw
- 450-WRD-510 Replacement Carrier

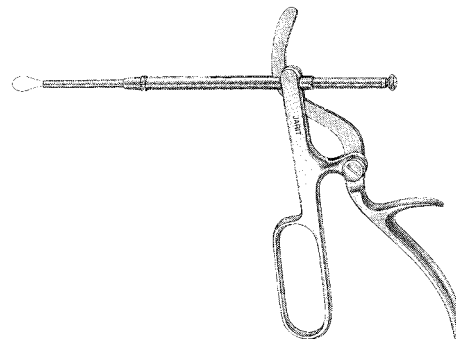

**Cut Snare Wires**

4½" (114mm), package of 12

Catalog #	Description
450-524	30 gauge (0.30mm)
450-525	28 gauge (0.35mm)
450-526	27 gauge (0.40mm)
450-527	26 gauge (0.45mm)
450-528	25 gauge (0.50mm)
450-529	24 gauge (0.55mm)



**Andrews-Pynchon Suction Tube**

Catalog #	Description
170-115	9 1/4" (234mm)

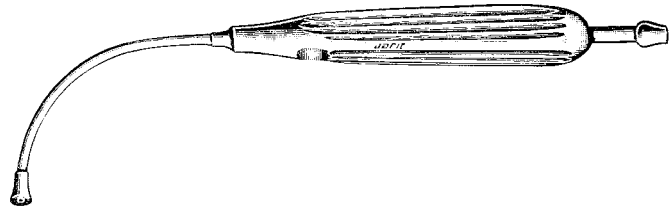

**Yankauer Suction Tube**

Catalog #	Description
170-118	8 1/4" (208mm), pediatric size

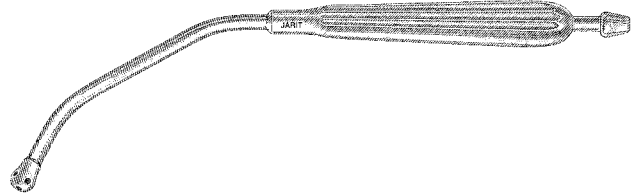

**Yankauer Suction Tube Parts**

Catalog #	Description
170-119	Tip for pediatric suction tube pkg/12ea

**Yankauer Suction Tube**

Catalog #	Description
170-120	11 1/4" (284mm), pediatric size

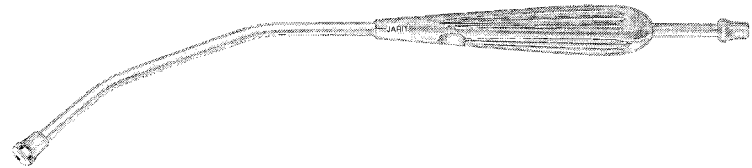

**Yankauer Suction Tube Parts**

Catalog #	Description
170-121	Tip for suction tube pkg/12ea

**Yankauer Suction Tube w/Control Valve**

Catalog #	Description
170-122	13" (330mm), stainless steel

**Yankauer Suction Tube Parts**

Catalog #	Description
170-121	Tip for suction tube pkg/12ea
170-SLV-122	Sleeve for suction tube

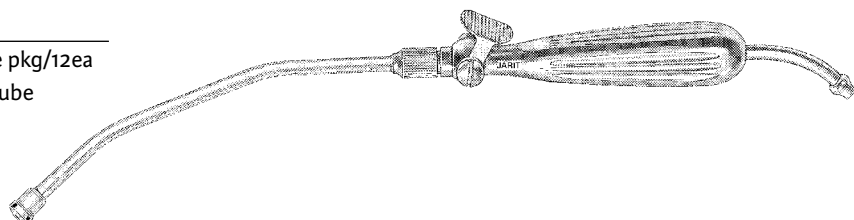



### Laryngeal Mirrors

threaded handle

Catalog #	Description
460-100	#00: 7 <sup>3</sup> / <sub>4</sub> ", 12mm diameter
460-101	#0: 7 <sup>3</sup> / <sub>4</sub> ", 14mm diameter
460-102	#1: 7 <sup>3</sup> / <sub>4</sub> ", 16mm diameter
460-103	#2: 7 <sup>7</sup> / <sub>8</sub> ", 18mm diameter
460-104	#3: 8", 20mm diameter
460-105	#4: 8", 22mm diameter
460-106	#5: 8 <sup>1</sup> / <sub>4</sub> ", 24mm diameter
460-107	#6: 8 <sup>1</sup> / <sub>4</sub> ", 26mm diameter
460-108	#7: 8 <sup>5</sup> / <sub>8</sub> ", 28mm diameter
460-109	#8: 8 <sup>5</sup> / <sub>8</sub> ", 30mm diameter

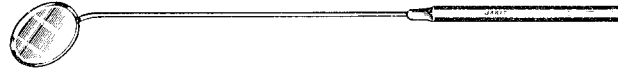

### Jackson Laryngeal Dressing Forceps

9<sup>1</sup>/<sub>2</sub>" (240mm)

Catalog #	Description
460-130	4mm x 2 teeth, 18mm serrated jaws

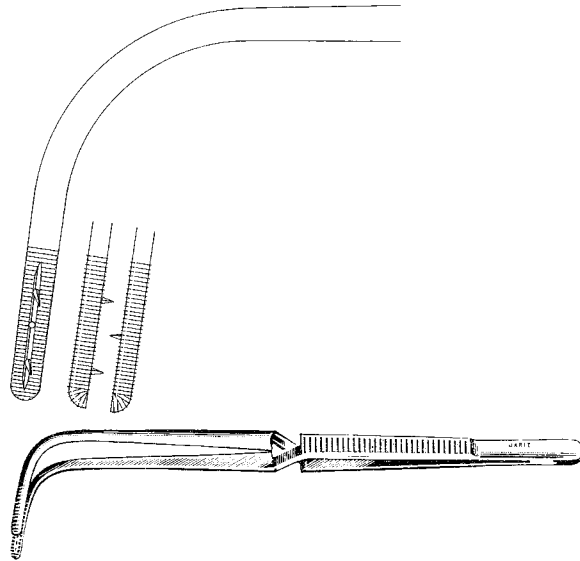

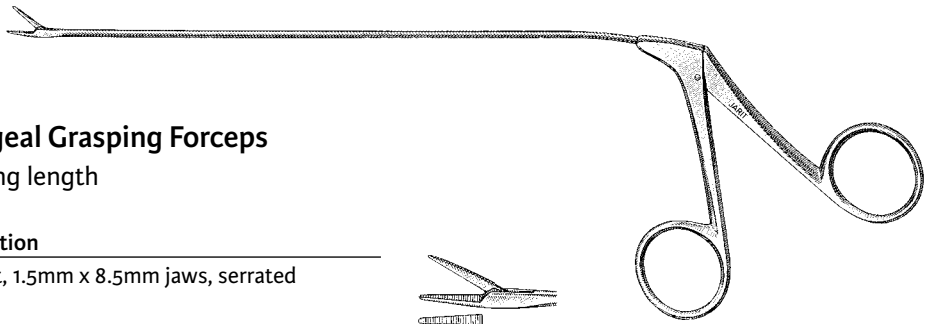

**Jako Micro-Laryngeal Grasping Forceps**

9<sup>3</sup>/<sub>4</sub>" (245mm) working length

**Catalog #**      **Description**

**460-230**      Straight, 1.5mm x 8.5mm jaws, serrated

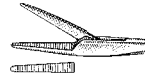

**460-231**      Curved left, 1.5mm x 8.5mm jaws, serrated



**460-232**      Curved right, 1.5mm x 8.5mm jaws, serrated

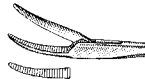

**Jako Micro-Laryngeal Cup Forceps**

9<sup>3</sup>/<sub>4</sub>" (245mm) working length

**Catalog #**      **Description**

**460-235**      Straight, 2.5mm cups

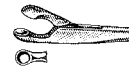

**460-236**      Angled left, 2.5mm cups

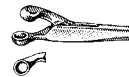

**460-237**      Angled right, 2.5mm cups

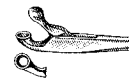

**460-240**      Angled up, 2.5mm cups

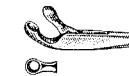

**Jako Micro-Laryngeal Scissors**

9¾" (245mm) working length

Catalog #	Description
460-245	Straight, vertical, 4.5mm blades
460-246	Angled up, 4.5mm blades
460-247	Curved left, 4.5mm blades
460-248	Curved right, 4.5mm blades
460-249	Straight, horizontal, 4.5mm blades

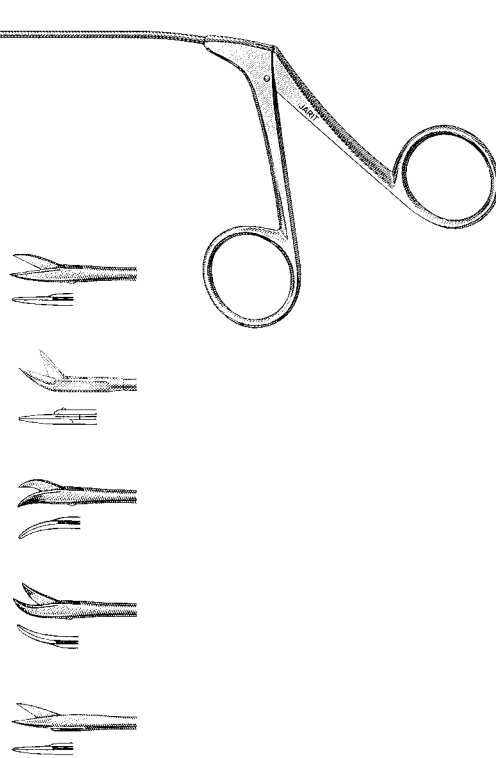

**Trousseau Tracheal Dilators**

Catalog #	Description
460-400	Adult: 5¾" (145mm), jaw width 5.5mm
460-401	Child: 5⅛" (130mm), jaw width 3.5mm

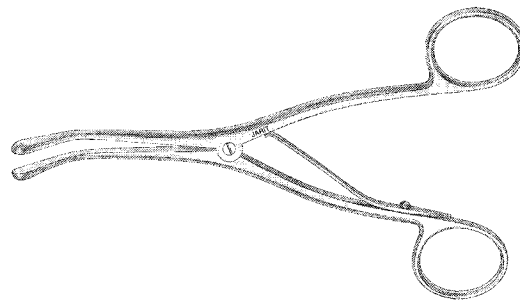

**La Borde Tracheal Dilators**

Catalog #	Description
460-405	5⅜" (138mm), 5.6mm wide side blades 3⅞" x ¼" (100mm x 6.4mm) center blade

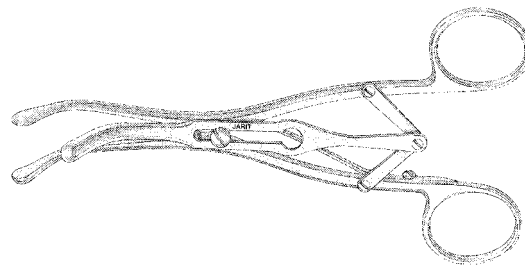

**Jackson Tracheal Hook**

5 7/8" (150mm)

Catalog #	Description
460-420	9mm hook

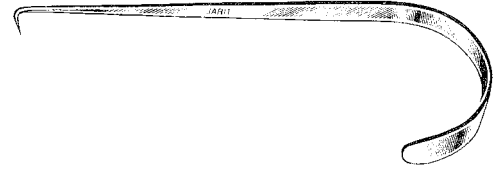

**Jackson Tracheal Retractor**

7" (176mm)

Catalog #	Description
460-425	Double-ended, 8mm wide double-hook, 10mm x 12.5mm retractor blade



**News Tracheal Hook**

5 7/8" (150mm)

Catalog #	Description
460-430	9.5mm hook



**Luer Tracheal Retractor**

4 3/8" (112mm)

Catalog #	Description
460-433	Double-ended, 3/8" x 7 1/6" (9.5mm x 11.5mm)

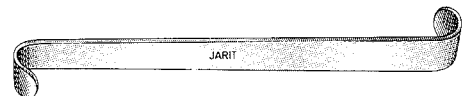

**Lukens Thymus Retractor**

7" (178mm)

Catalog #	Description
460-435	Double-ended, 3/8" x 1/2" (10mm x 12.5mm), 5/16" x 5/8" (8mm x 16.5mm)



**Jackson Tracheal Hemostat**

5½" (140mm)

Catalog #	Description
460-440	Curved

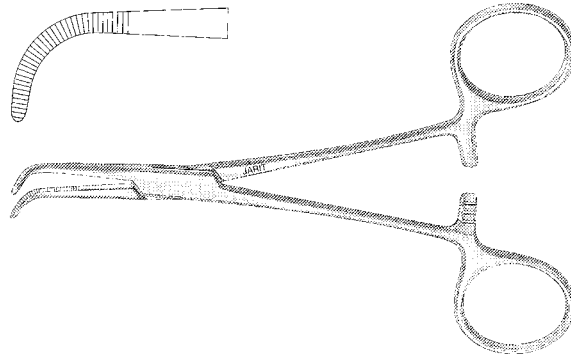

**Jackson Tracheal Tubes**

original model, stainless steel,  
length is measured on inside curve of tube

Catalog #	Description
460-600	Size 2-0: 4.5mm O.D., 37mm length
460-601	Size 0: 5mm O.D., 45mm length
460-602	Size 1: 5.5mm O.D., 51mm length
460-603	Size 2: 6mm O.D., 59mm length
460-604	Size 3: 7mm O.D., 67mm length
460-605	Size 4: 8mm O.D., 71mm length
460-606	Size 5: 9mm O.D., 81mm length
460-607	Size 6: 10mm O.D., 83mm length
460-608	Size 7: 11mm O.D., 84mm length
460-609	Size 8: 12mm O.D., 86mm length
460-610	Size 9: 13mm O.D., 89mm length
460-611	Size 10: 14mm O.D., 91mm length

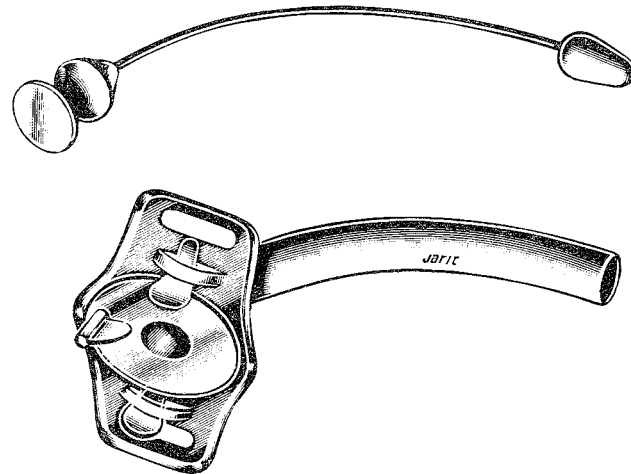

### Jackson Tracheal Tubes

improved model, stainless steel,  
length is measured on inside curve of tube

Catalog #	Description
460-620	Size 2-0: 4.5mm O.D., 37mm length
460-621	Size 0: 5mm O.D., 45mm length
460-622	Size 1: 5.5mm O.D., 51mm length
460-623	Size 2: 6mm O.D., 59mm length
460-624	Size 3: 7mm O.D., 67mm length
460-625	Size 4: 8mm O.D., 71mm length
460-626	Size 5: 9mm O.D., 81mm length
460-627	Size 6: 10mm O.D., 83mm length
460-628	Size 7: 11mm O.D., 84mm length
460-629	Size 8: 12mm O.D., 86mm length
460-630	Size 9: 13mm O.D., 89mm length
460-631	Size 10: 14mm O.D., 91mm length

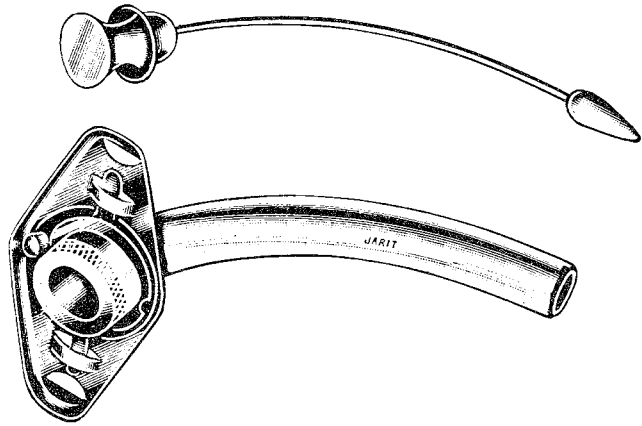

### Jackson Tracheal Tubes

short model, stainless steel,  
length is measured on inside curve of tube

Catalog #	Description
460-640	Size 2-0: 4.5mm O.D., 30mm length
460-641	Size 0: 5mm O.D., 38mm length
460-642	Size 1: 5.5mm O.D., 44mm length
460-643	Size 2: 6mm O.D., 53mm length
460-644	Size 3: 7mm O.D., 60mm length
460-645	Size 4: 8mm O.D., 65mm length
460-646	Size 5: 9mm O.D., 74mm length
460-647	Size 6: 10mm O.D., 76mm length
460-648	Size 7: 11mm O.D., 78mm length
460-649	Size 8: 12mm O.D., 79mm length
460-650	Size 9: 13mm O.D., 82mm length
460-651	Size 10: 14mm O.D., 84mm length

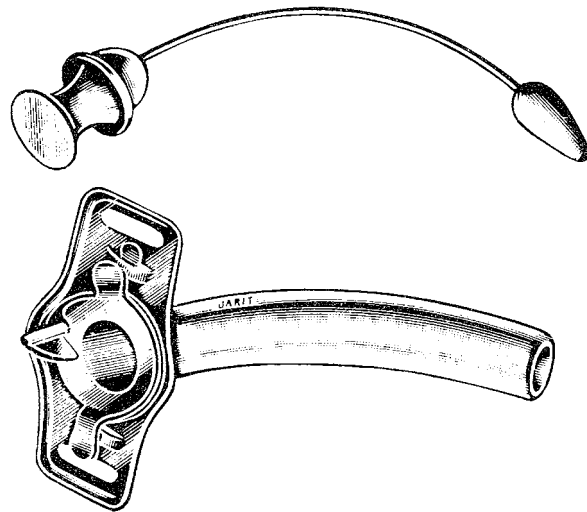



**Integra™**  
Dental & Oral  
Instruments

**Explorer, Double Ended**

Catalog #	Description
835-100	#5



**Explorer, Single Ended**

Catalog #	Description
835-105	#23



**Excavator, Double Ended**

Catalog #	Description
835-110	#18



**Excavator, Double Ended**

Catalog #	Description
835-115	#19



**Excavator, Double Ended**

Catalog #	Description
835-120	#3/6 cleoid/discoid



**Excavator, Double Ended**

Catalog #	Description
835-125	#89/92 cleoid/discoid





### Hollenbach Plugger, Double Ended

Catalog #	Description
835-130	#1



835-135	#2
---------	----



### Ward Wax Carver, Double Ended

Catalog #	Description
835-140	#2



### Wall Wax Carver, Double Ended

Catalog #	Description
835-145	#1 ball tip



### Burnisher, Double Ended

Catalog #	Description
835-150	#27/29



835-155	#1 Ball tip
---------	-------------



835-160	#28/29
---------	--------



835-165	#21 acorn tip
---------	---------------



**Plastic Filling Instrument, Double Ended**

Catalog #	Description
835-170	#4



**Woodson Plastic Filling Instrument, Double Ended**

Catalog #	Description
835-175	#1
835-180	#2



**Cement Spatula, Flexible**

Catalog #	Description
835-185	#24

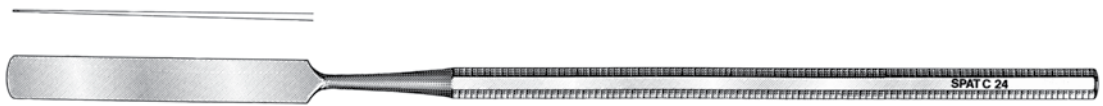

**Cement Spatula, Rigid**

Catalog #	Description
835-190	#24



**Wax Spatula, small end with one flat side**

Catalog #	Description
835-195	#7A



INCHES  
MILLIMETERS

**Lucas Bone Curette, Double Ended**

Catalog #	Description
835-200	#85



835-205	#86
---------	-----



835-210	#87
---------	-----



**Molt Bone Curette, Double Ended**

Catalog #	Description
835-215	#2/4

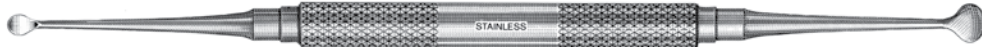

**Molt Bone Curette, Single Ended**

Catalog #	Description
835-220	#1



835-235	#2
---------	----



835-240	#4
---------	----



**Howard Bone File, Double Ended**

Catalog #	Description
835-300	#12

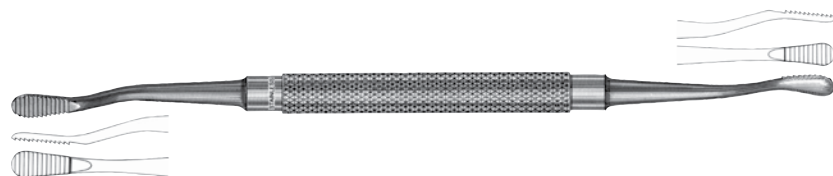

**Bell Pattern Bone File, Double Ended**

Catalog #	Description
835-305	#12A

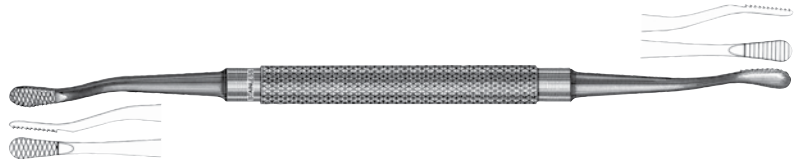

835-310	#12CA
---------	-------



**Gardner Bone Chisel**

Catalog #	Description
835-400	#1



835-405	#2
---------	----



835-410	#5
---------	----



**Apical Dental Elevator**

Catalog #	Description
835-500	#301



835-510	#302
---------	------



835-515	#303
---------	------

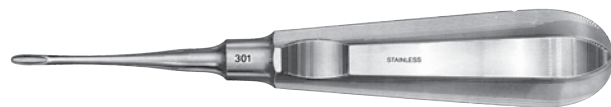

**Crane Pick Elevator**

Catalog #	Description
835-505	#8



**Cogswell A "Spade" Elevator**

Catalog #	Description
835-520	A "Spade"



**Root Tip Dental Elevator**

Catalog #	Description
835-525	#34
835-530	#34S

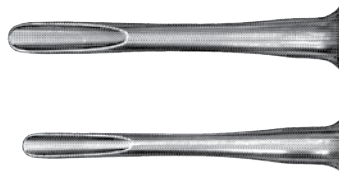

**Seldin Elevator**

Catalog #	Description
835-540	#1L
835-541	#1R
835-542	#4L
835-543	#4R



**Cryer Elevator**

Catalog #	Description
835-545	#44
835-546	#45

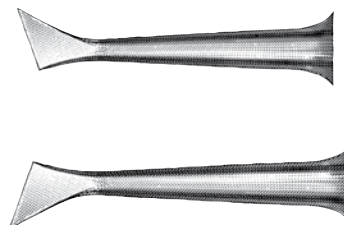

**Heidbrink Root-Tip Picks**

Catalog #	Description
835-550	#H1
835-551	#H2
835-555	#H3



**Heidbrink Root-Tip Pick**

Catalog #	Description
835-552	#H2-3



**Potts T-Handle Elevator**

Catalog #	Description
835-560	#6X
835-561	#7X

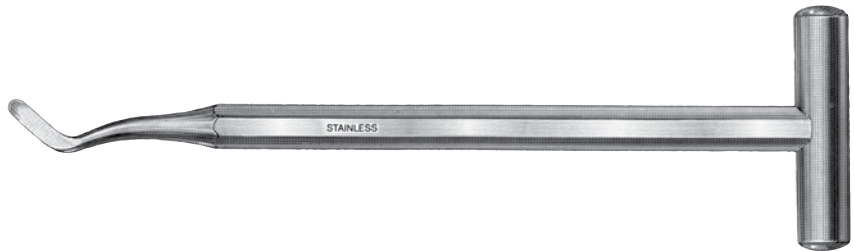

### Dental Extraction Forceps

Catalog #	Description
836-145	#53L upper molar: left, 1st and 2nd upper molars

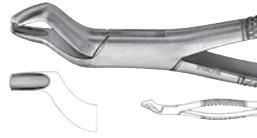

836-146	#53R upper molar: right, 1st and 2nd upper molars
---------	---

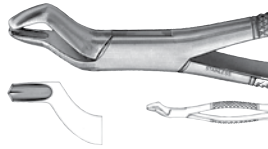

836-155	#88L upper molar: left, 1st and 2nd upper molars
---------	--

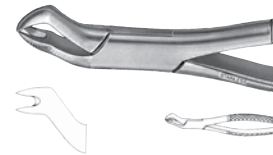

836-160	#88R upper molar: right, 1st and 2nd upper molars
---------	---

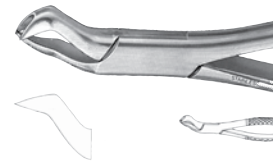

### Dental Extraction Forceps

Catalog #	Description
836-165	#89L upper molars: left

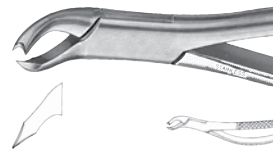

836-170	#90R upper molars: right
---------	--------------------------

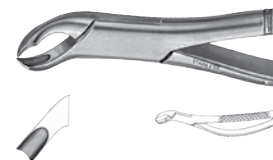

836-100	#23 lower molar: 1st and 2nd upper molars cow horn, universal
---------	---

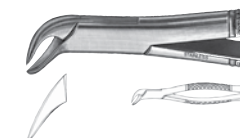

**Dental Extraction Forceps**

Catalog #	Description
836-105	#150 upper anteriors, upper incisor and cuspids, bicuspid and roots, universal
836-110	#150AS upper anteriors, split breaks, serrated
836-120	#151 lower anteriors, lower incisor and cuspids, bicuspid and roots, universal
836-125	#151AS lower anteriors, split breaks, serrated

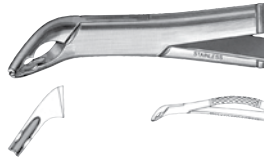
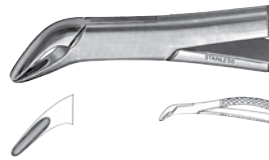
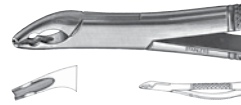
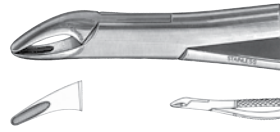

**Dental Extraction Forceps**

Catalog #	Description
836-175	#99C upper anteriors, upper incisors, cuspids and bicuspid
836-180	#MD1, mead pattern, upper incisors, cuspids and bicuspid, mead, universal
836-205	#101 anteriors and splitting upper and lower bicuspid and deciduous, universal
836-210	#286 upper anteriors upper bicuspid, incisors and roots

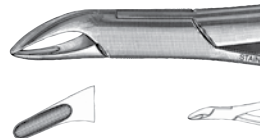
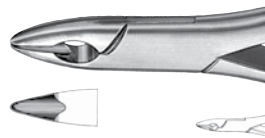



**Dental Extraction Forceps, Pedodontic**

Catalog #	Description
836-115	#150S pedo-extracting forceps, pedo upper incisors, bicuspid and roots, universal
836-130	#151S pedo-extracting forceps, pedo lower incisors, bicuspid and roots, universal
836-135	#150XAS pedo-extracting forceps, pedo upper anteriors, split breaks, serrated
836-140	#16S pedo-extracting forceps, pedo lower molars, cow horn

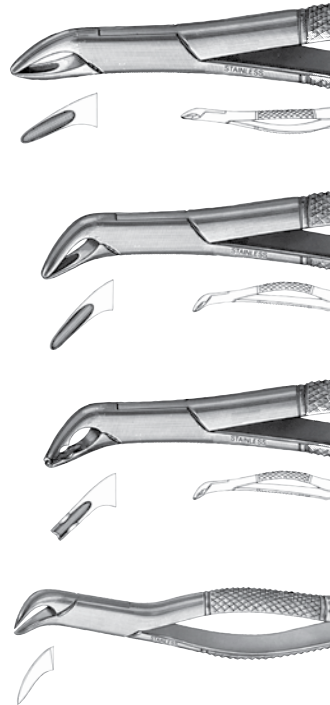

**Dental Extraction Forceps, English Pattern**

Catalog #	Description
836-195	#A pedo-extracting forceps, English pattern, pedo upper molars, mini, universal
836-200	#C pedo-extracting forceps, English pattern, pedo lower molars, mini, universal
836-150	#74 extracting forceps, English pattern, lower roots
836-185	#73 extracting forceps, English pattern, lower molars, universal

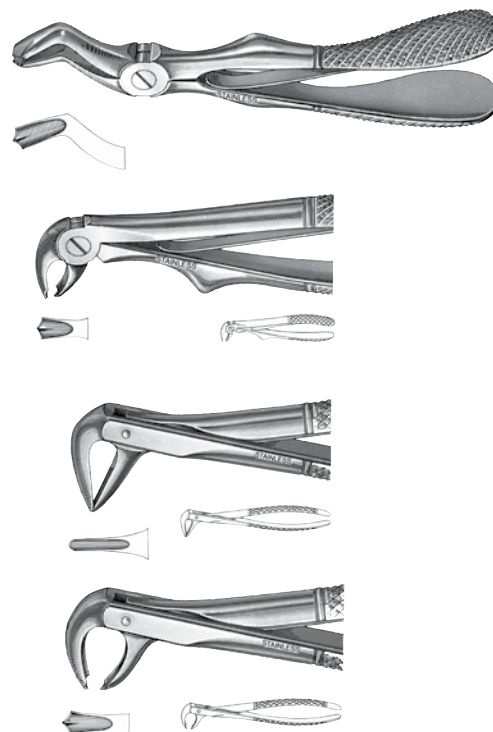

**Hanahan Extraction Forceps**

Catalog #	Description
836-190	#1, upper incisor

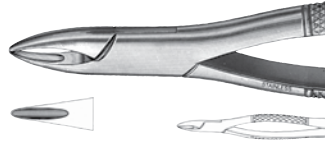

**Oral Surgery Rongeurs**

Catalog #	Description
837-100	#5, 6¾" (172mm)

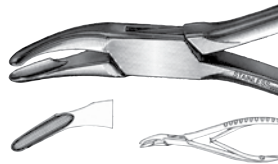

837-105	#4, 5½" (140mm)
---------	-----------------



**Mini-Blumenthal Rongeur**

Catalog #	Description
837-110	4½" (115mm), 30 deg curved jaw

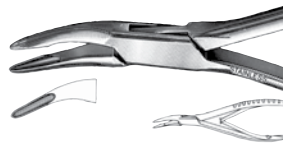

**Micro-Friedman Rongeur**

Catalog #	Description
837-115	5½" (140mm), 15 deg curved jaw

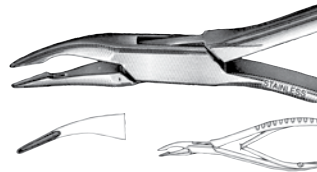

**Mead Rongeur, #1A**

Catalog #	Description
837-120	6½" (165mm)

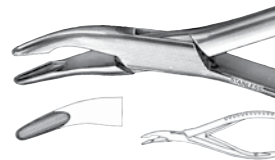

**Amalgam Carrier, w/Stainless Barrels, double ended**

Catalog #	Description
838-200	Medium/Large



**Toffmire Type Matrix Retainer-Universal**

Catalog #	Description
838-210	Universal

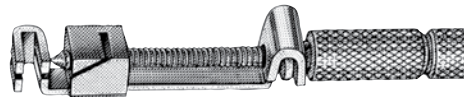

**Aspirating Syringe**

Catalog #	Description
838-215	C-W type, 1.8cc



**300X One Piece Construction Band Pusher**

Catalog #	Description
838-220	Construction Band Pusher

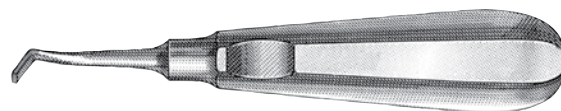
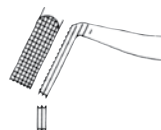

**Denhardt Mouth Gag, with Grip Lock**

Catalog #	Description
838-250	with Grip Lock

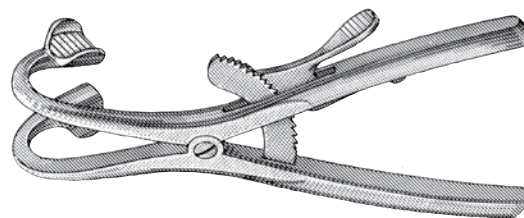

**University of Minnesota Cheek Retractor**

Catalog #	Description
838-270	5 1/2" (140mm)



**Quimby Gum Scissors**

Catalog #	Description
838-500	5" (127mm), full curve

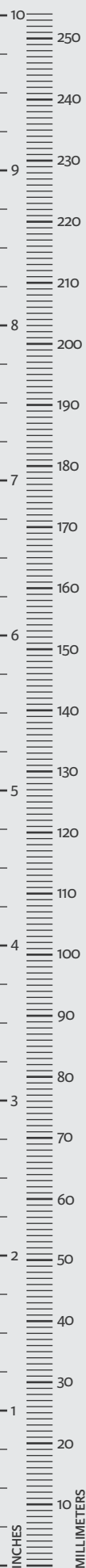
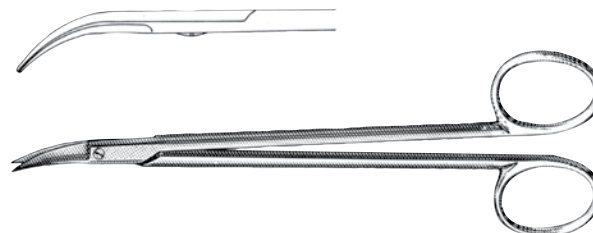

**Integra**<sup>™</sup>  
Rectal &  
Genito-Urinary  
Instruments and  
General Surgical  
Instruments

**Pratt Rectal Speculum**

7½" (190mm)

Catalog #	Description
475-100	Blades 3¾" deep x 1" wide (87mm x 25mm), diameter at opening 1⅞" (47mm)

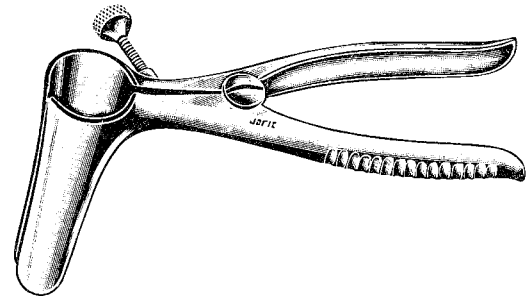

**Bodenhammer Rectal Speculum**

5⅞" (150mm)

Catalog #	Description
475-105	Blades 3½" deep x ¾" wide (90mm x 18mm), diameter at opening 1" (25mm)

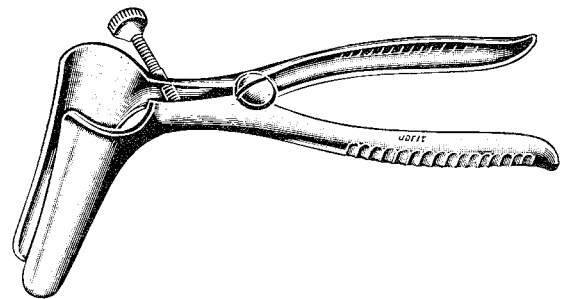

**Sims Rectal Speculum**

5⅞" (150mm)

Catalog #	Description
475-110	Blades 3½" deep x ⅝" wide (90mm x 17mm), diameter at opening 1" (25mm)

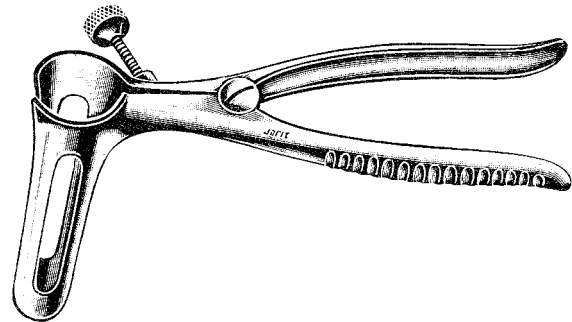

**Barr Anal Retractor**

7½" (190mm)

Catalog #	Description
475-120	Self-retaining blades 2¾" deep x ⅞" wide (70mm x 22mm)

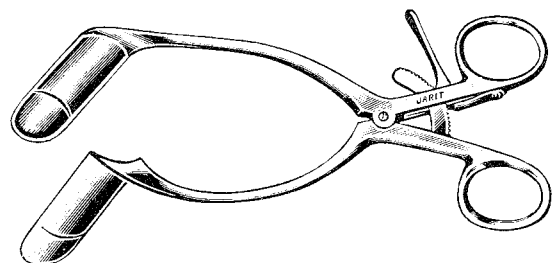

### Smith Anal Retractor

Catalog #	Description
475-125	Maximum opening 4" (102mm), swivel blades 2¾" deep x 7/8" wide (70mm x 22mm)
475-ESC-125	Replacement End Screw Pkg/3ea

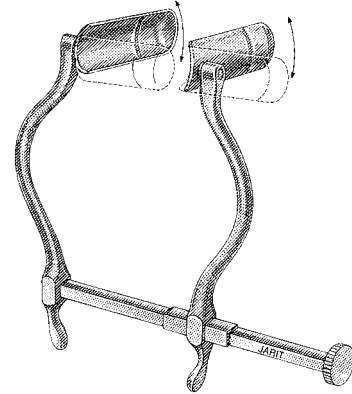

### Fansler Operating Speculum

7¾" (198mm)

Catalog #	Description
475-127	Slotted tube 2¾" long x 1¾" diameter (60mm x 35mm)
475-OBT-127	Replacement Obturator

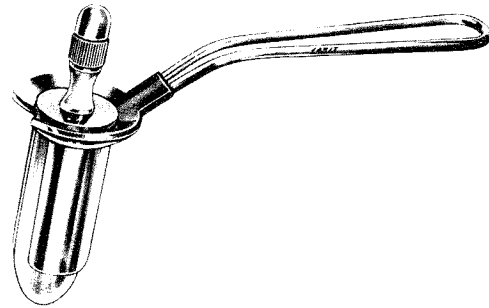

### Fansler (Ives) Rectal Speculum

Catalog #	Description
475-130	3¼" long x 1⅞" diameter (83mm x 28mm)
475-131	Replacement Plastic Obturator

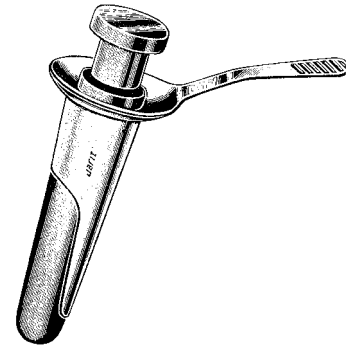

### Chelsea-Eaton Anal Specula

Catalog #	Description
475-140	Small: 2¾" long x 7/8" diameter (70mm x 22mm)
475-142	Large: 2¾" long x 1⅞" diameter (70mm x 30mm)
475-OBT-140	Replacement Obturator
475-OBT-142	Replacement Obturator

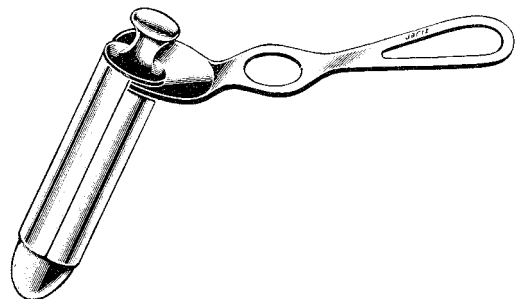

**Hirschman Anoscopes**

Catalog #	Description
475-150	Small: 2 3/8" long x 5/8" diameter (60mm x 16mm)
475-152	Medium: 2 3/4" long x 3/4" diameter (70mm x 19mm)
475-155	Large: 3 1/2" long x 1" diameter (90mm x 24mm)
475-OBT-150	Replacement Obturator
475-OBT-152	Replacement Obturator
475-OBT-155	Replacement Obturator

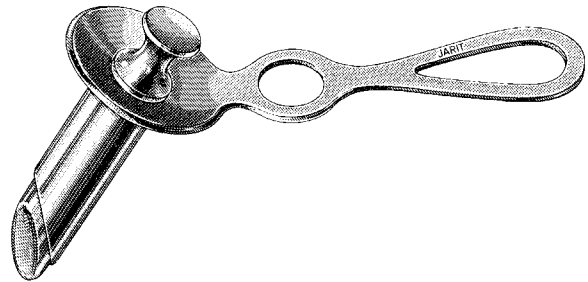

**Brinkerhoff Rectal Specula**

Catalog #	Description
475-160	Small: 3 1/2" long x 1" diameter (90mm x 25mm), tapering to 1/2" (12mm)
475-162	Medium: 4" long x 1" diameter (100mm x 25mm), tapering to 1/2" (12mm)
475-165	Large: 4 3/4" long x 1 1/4" diameter (120mm x 32mm), tapering to 3/4" (14mm)
475-SLD-160	Replacement Slide Bar

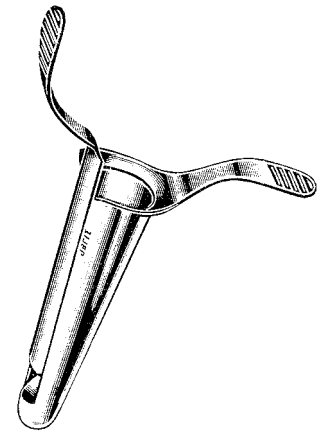

**Kelly Proctoscopes**

7/8" diameter (22mm)

Catalog #	Description
475-175	Small: 2" long (51mm)
475-176	Medium: 4" long (100mm)
475-177	Large: 5 1/2" long (140mm)
475-SLD-160	Replacement Slide Bar

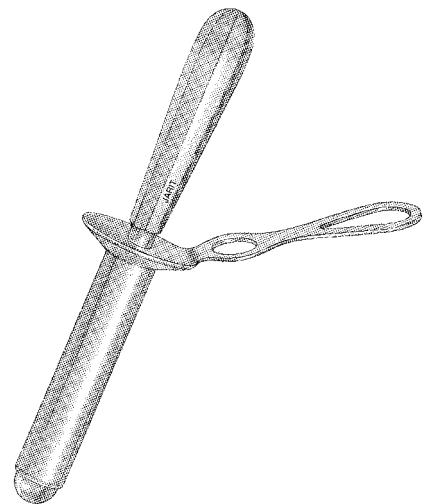



### Hill-Ferguson Rectal Retractors

Catalog #	Description
475-180	Small: 2½" x 1" wide (64mm x 25mm) blade, angled 20 deg
475-181	Medium: 2¾" x 1½" wide (70mm x 29mm) blade, angled 20 deg
475-182	Large: 3¼" x 1⅝" wide (81mm x 40mm) blade, straight

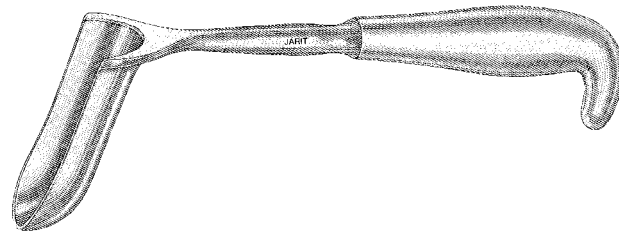

### Sawyer Rectal Retractors

Catalog #	Description
475-185	Small: 2¼" x 7⁄8" (56mm x 22mm) blade
475-186	Medium: 2¾" x 1⅛" (69mm x 29mm) blade
475-187	Large: 3¼" x 1½" (84mm x 38mm) blade

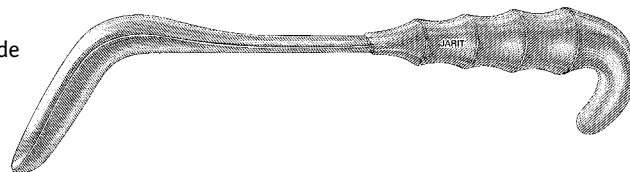

### Yeoman Biopsy Forceps

rotating shaft, 4mm x 12mm straight jaws

Catalog #	Description
475-212	13" (330mm)
475-214	16¼" (410mm)

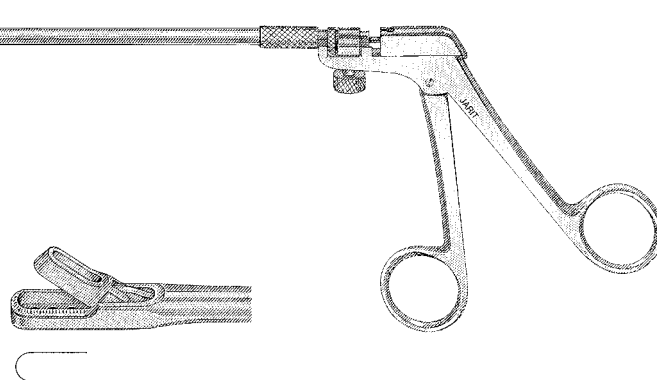

### Turrell Biopsy Forceps

rotating shaft, 4mm x 11mm angled jaws

Catalog #	Description
475-222	13" (330mm)
475-224	16¼" (410mm)

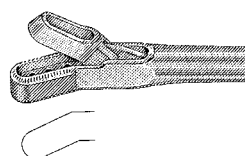

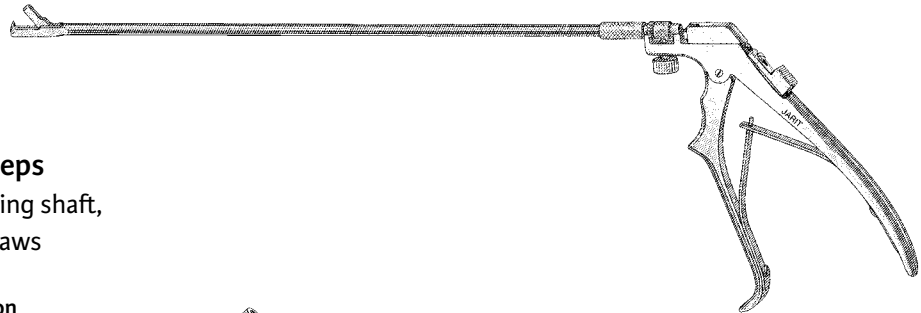

**Yeoman Biopsy Forceps**  
improved handle, rotating shaft,  
6mm x 12mm straight jaws

Catalog #	Description
475-232	13" (330mm)
475-234	16 1/4" (410mm)

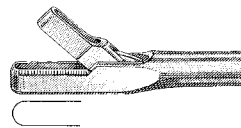

**Turrell Biopsy Forceps**  
improved handle, rotating shaft,  
6mm x 12mm angled jaws

Catalog #	Description
475-242	13 1/4" (335mm)
475-244	16" (406mm)

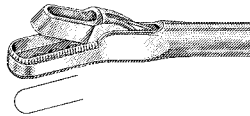

**Yeoman Biopsy Forceps**  
improved handle, rotating shaft,  
6mm x 12mm straight jaws with teeth

Catalog #	Description
475-252	13 1/4" (335mm)
475-254	16" (406mm)

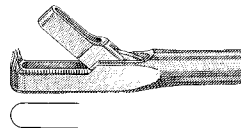

**Turrell Biopsy Forceps**  
improved handle, rotating shaft,  
6mm x 12mm angled jaws with teeth

Catalog #	Description
475-262	13 1/4" (335mm)
475-264	16 1/4" (410mm)

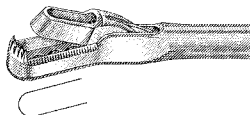

### McGivney Hemorrhoidal Ligator

Catalog #	Description
475-305	7¼" (182mm), improved model, with offset handle

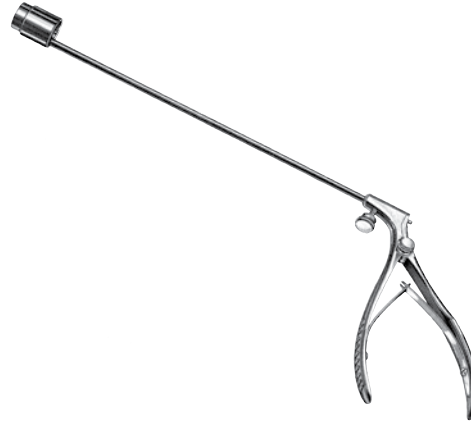

### McGivney Hemorrhoidal Grasping Forceps

Catalog #	Description
475-306	7½" (190mm), angled shanks, for use with McGivney ligator



### McGivney Ligator Set

Catalog #	Description
475-307	Includes 475-305 hemorrhoidal ligator, 475-LC-305 drum loading cone, 475-OR-305 100 latex o-rings
475-OR-305	Replacement O-Rings 100/per
475-LC-305	Replacement Loading Cone

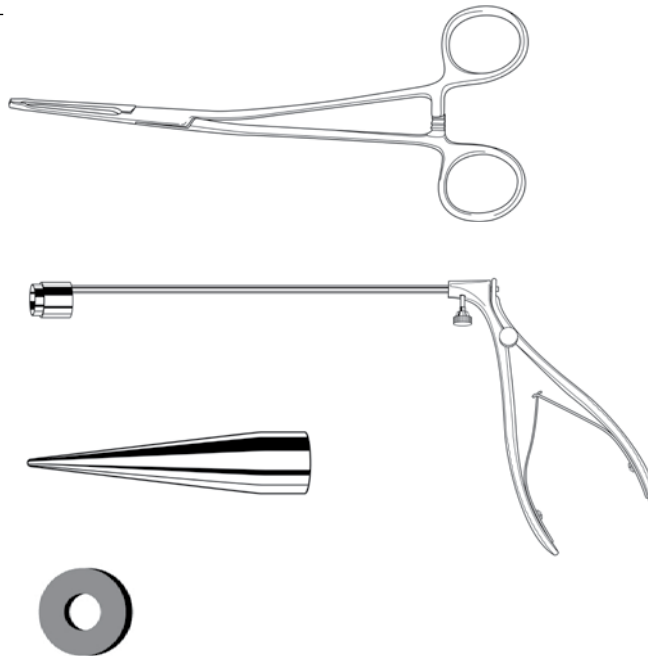

**Buie Rectal Suction Tube**

Catalog #	Description
475-310	16½" (420mm) working length, 12 French, with finger valve

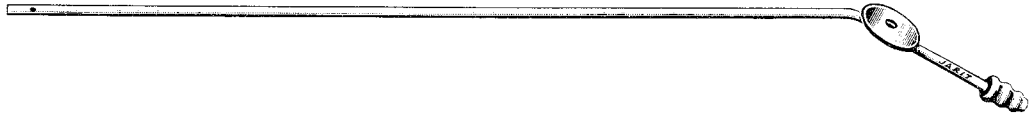

**Buie Pile Clamp**

Catalog #	Description
475-320	8¼" (207mm) curved

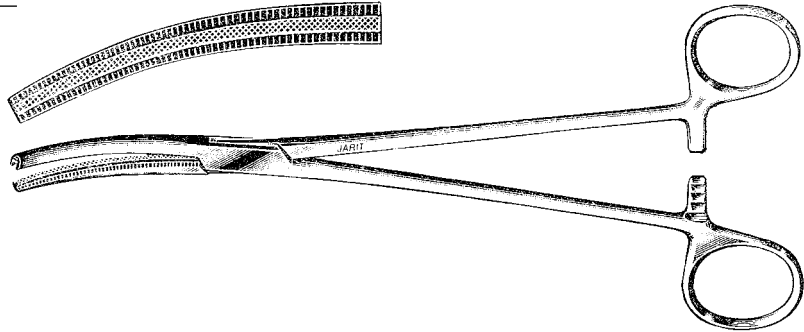

**Buie Fistula Probes**

5<sup>3</sup>/<sub>8</sub>" (137mm)

Catalog #	Description
475-330	Light model, 1.5mm probe tip
475-331	Heavy model, 2mm probe tip



**Barr Fistula Probes**

Catalog #	Description
475-333	5 <sup>1</sup> / <sub>2</sub> " (140mm), 1.5mm double-ended

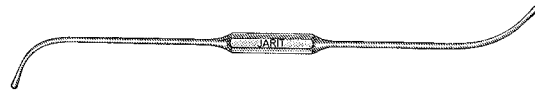

**Pratt Rectal Probe**

Catalog #	Description
475-335	7 <sup>3</sup> / <sub>4</sub> " (200mm), 1.8mm probe tip, malleable, silver



**Larry Rectal Probe and Grooved Director**

Catalog #	Description
475-337	6 <sup>1</sup> / <sub>2</sub> " (164mm) working length, 2mm probe tip



**Rosser Crypt Hook**

Catalog #	Description
475-340	7" (177mm), 10.5mm hook x 2.85mm probe tip



**Stewart Crypt Hook**

Catalog #	Description
475-342	9" (230mm), hook <sup>3</sup> / <sub>4</sub> " (20mm)



**Kelly Fistula Scissors**

6¼" (158mm)

Catalog #	Description
100-280	Straight
100-281	Curved

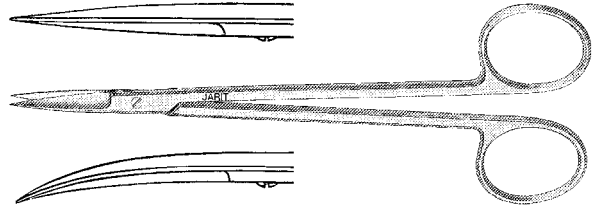

**Pratt Smith T-Clamp**

5⅞" (150mm)

Catalog #	Description
105-255	16mm wide jaws

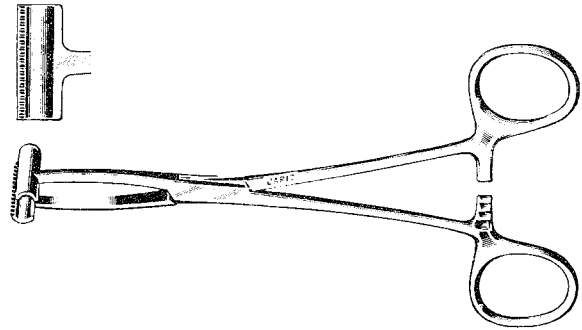

**Pennington Forceps**

6¼" (156mm)

Catalog #	Description
105-320	11mm wide triangular jaws

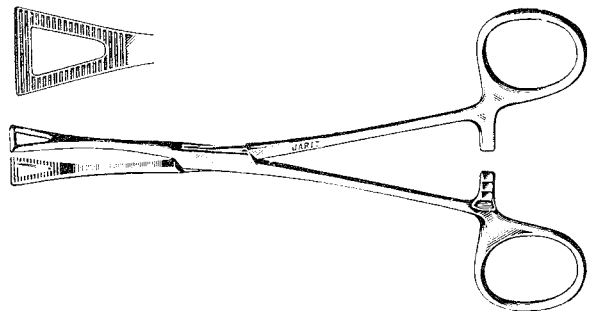

## Otis Urethrotome

Catalog #	Description
475-415	11¾" (301mm), in wood case

## Otis Urethrotome, Blade only

Catalog #	Description
475-416	10¼" (260mm), 3.5mm x 12mm blade
475-STP-415	Replacement Small Tip
475-LTP-415	Replacement Large Tip
475-CTP-415	Replacement Curved Tip

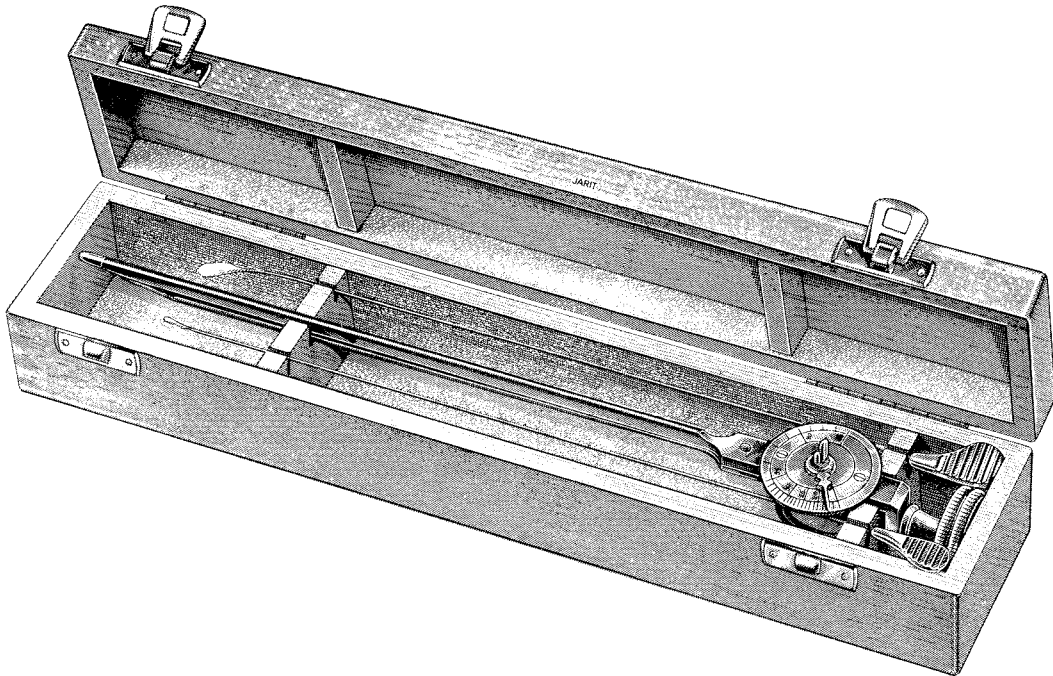

**Young Prostatic Retractor**

8½" (216mm)

Catalog #	Description
475-425	Notched blade, 1" x 1⅛" long (25mm x 27mm)

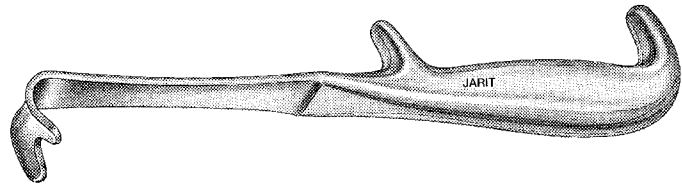

**Young Prostatic Retractor**

8½" (216mm)

Catalog #	Description
475-426	Anterior blade, 1⅝" x 2⅜" long (41mm x 61mm)

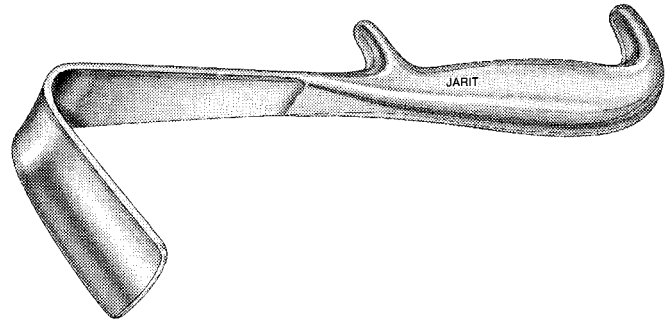

**Young Prostatic Retractor**

8¾" (220mm)

Catalog #	Description
475-427	Lateral blade, ½" x 2¼" long (12.5mm x 56mm)

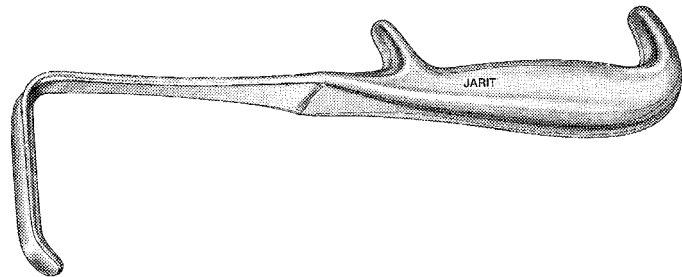

**Young Prostatic Retractor**

9" (229mm)

Catalog #	Description
475-428	Divided blade, 1⅝" x 1½" long (40mm x 39mm)

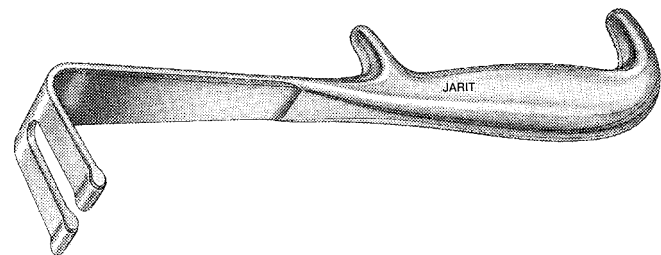

**Judd-Masson Blade Retractor**

Catalog #	Description
475-440	Maximum opening: 4¾" (121mm), Swivel blades: 1" x 2¾" deep (25mm x 70mm) Center blade: 1" x 2¾" deep (25mm x 70mm)

- 475-CBL-440 Replacement Center Blade
- 475-WNA-440 Replacement Wing Nut Assembly

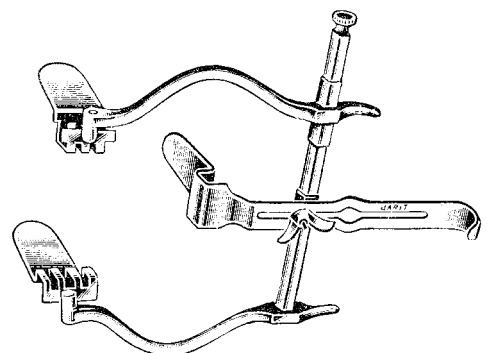



### Randall Kidney Stone Forceps

Catalog #	Description
475-470	1/4 curve, 9 1/4" (237mm)
475-471	1/2 curve, 8 1/2" (219mm)
475-472	3/4 curve, 7 3/4" (198mm)
475-473	Full curve, 7 1/2" (190mm)

Details shown at 1/2 size

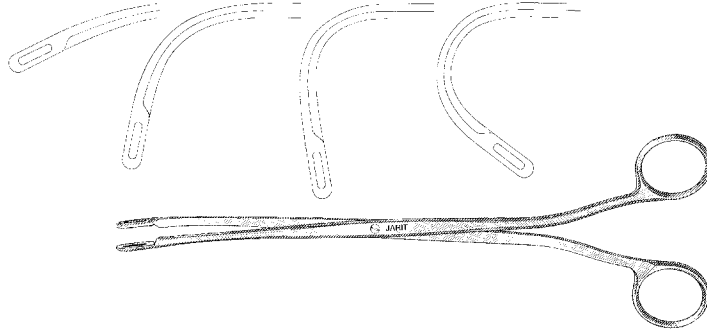

### Gil-Vernet Renal Sinus Retractors

9 1/4" (238mm)

Catalog #	Description
475-490	9mm wide blade
475-491	11mm wide blade
475-492	13mm wide blade
475-493	15mm wide blade
475-494	18mm wide blade

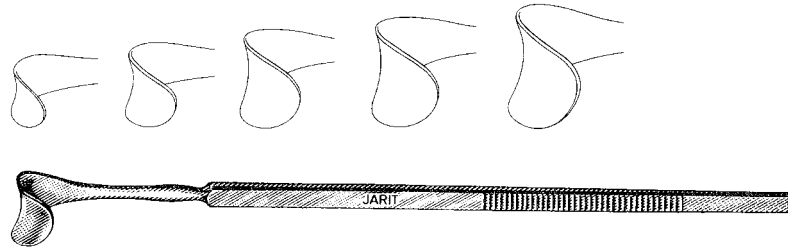

### No Scalpel Vasectomy Ring Clamp

Catalog #	Description
475-480	5 1/2" (140mm), 5mm ring



### No Scalpel Vasectomy Hemostat

Catalog #	Description
475-485	5 1/8" (130mm), curved smooth pointed tips



**Stille Vessel Clamp**

8¾" (225mm) overall length

Catalog #	Description
475-500	3" (75mm) jaw working length

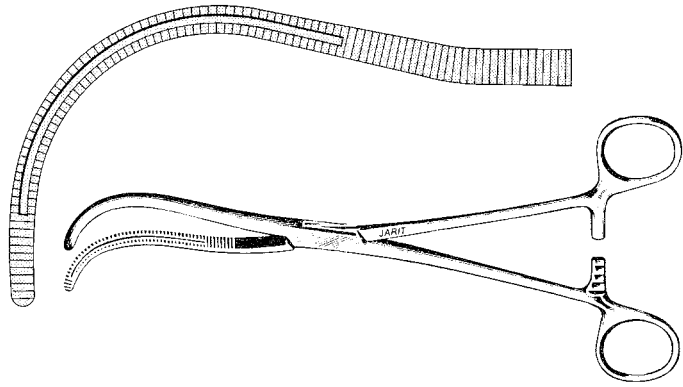

**Mayo (Guyon Vessel Clamp)**

10½" (265mm) overall length

Catalog #	Description
475-505	2" (52mm) jaw working length

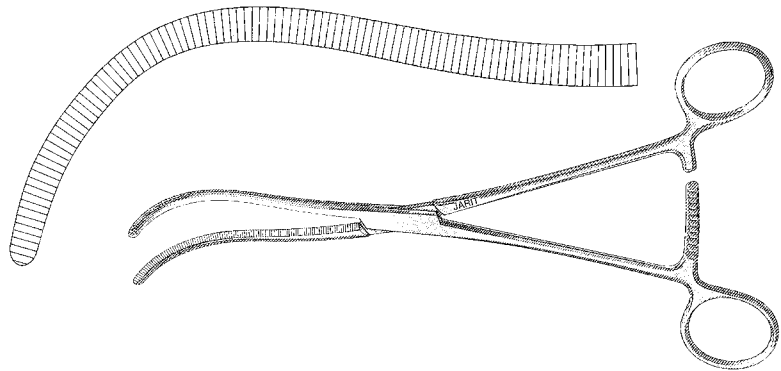

**Herrick Kidney Clamp**

9" (228mm) overall length

Catalog #	Description
475-510	2" (52mm) jaw working length

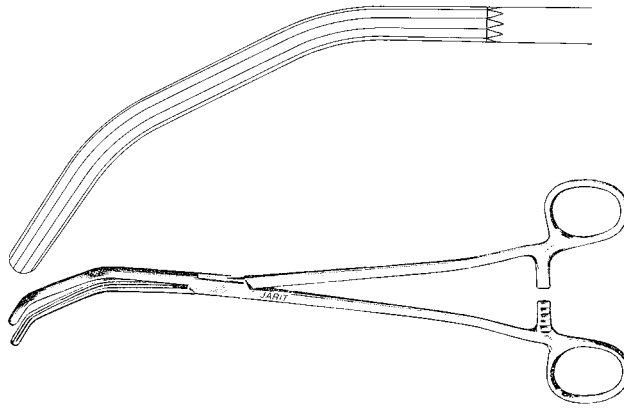

**Wertheim Pedicle Clamp**

10½" (265mm) overall length

Catalog #	Description
475-520	2" (52mm) jaw working length

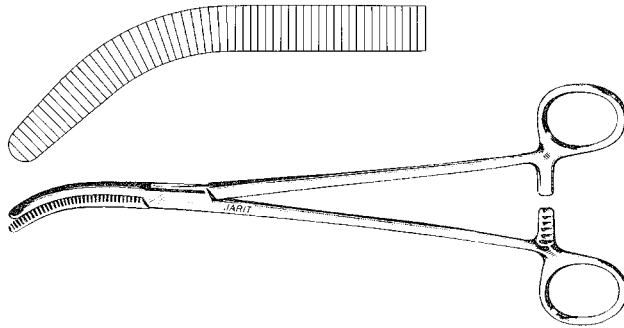

**Wertheim-Cullen Pedicle Clamp**

18¼" (211mm) overall length

Catalog #	Description
475-525	2¾" (60mm) jaw working length

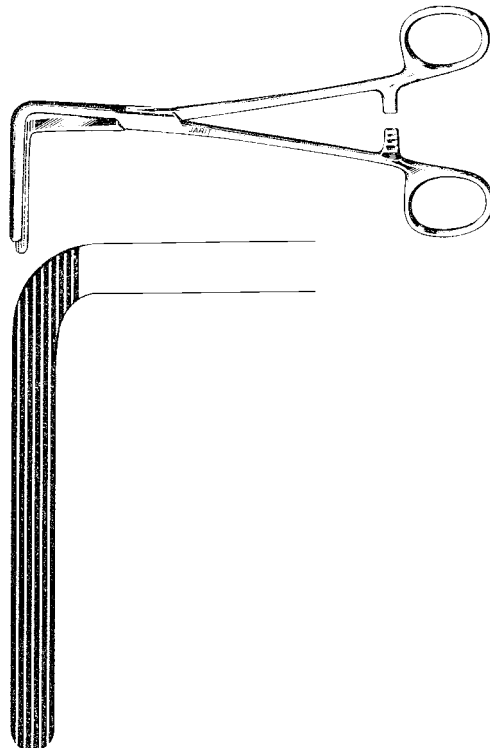

### Van Buren Urethral Sounds

10<sup>3</sup>/<sub>4</sub>" (270mm)

Catalog #	Description
475-550	8 French
475-551	10 French
475-552	12 French
475-553	14 French
475-554	16 French
475-555	18 French
475-556	20 French
475-557	22 French
475-558	24 French
475-559	26 French
475-560	28 French
475-561	30 French
475-562	32 French
475-563	34 French
475-564	36 French



### Mcree Infant Urethral Sounds

7<sup>1</sup>/<sub>4</sub>" (185mm)

Catalog #	Description
475-535	8 French
475-536	10 French
475-537	12 French
475-538	14 French
475-539	16 French
475-540	18 French
475-541	20 French
475-542	22 French
475-543	24 French
475-544	26 French
475-545	28 French
475-546	30 French
475-547	32 French
475-548	34 French
475-549	36 French



### Female Catheter

5<sup>7</sup>/<sub>8</sub>" (150mm)

Catalog #	Description
475-634	12 French
475-635	14 French
475-636	16 French
475-637	18 French



**Integra™**  
Obstetrics &  
Gynecology  
Instruments and  
General Surgical  
Instruments

### Graves Vaginal Specula

Catalog #	Description
500-100	Small blade: 3/4" x 3 1/4" (20mm x 83mm)
500-105	Medium blade: 1 3/8" x 4 3/8" (35mm x 110mm)
500-110	Large blade: 1 1/2" x 5" (37mm x 126mm)
500-KNT-100	Replacement Knurled Nut Pkg/12ea for 500-100, 05, 110

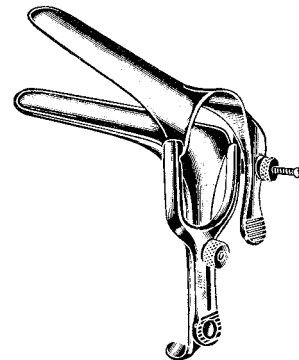

### Pederson Vaginal Specula

Catalog #	Description
500-115	Small blade: 1/2" x 3 3/8" (14mm x 85mm)
500-120	Medium blade: 1" x 4 5/8" (24mm x 117mm)
500-125	Large blade: 1" x 5 1/8" (26mm x 129mm)
500-KNT-100	Replacement Knurled Nut Pkg/12ea for 500-100, 05, 110
500-TSC-115	Replacement Thumb Screw for 500-115, 120, 125
500-TSA-115	Replacement Thumbscrew Assembly

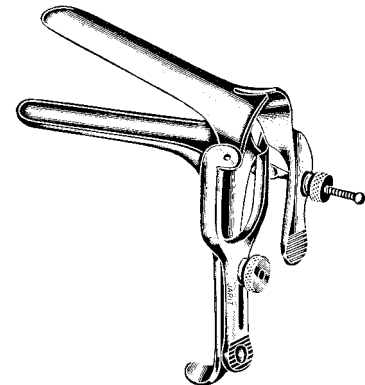

### Pederson Vaginal Speculum

Catalog #	Description
500-130	Blade 5/8" x 4 1/2" (17mm x 113mm)
500-TSC-115	Replacement Thumb Screw

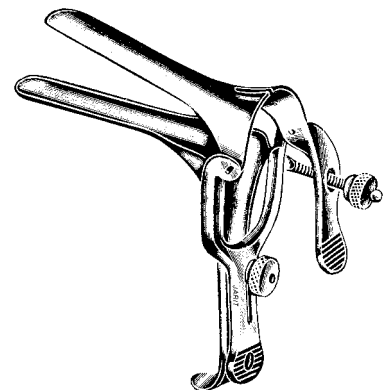

### Graves Open-Side Vaginal Speculum

Catalog #	Description
500-135	Blade 1 3/8" x 4 1/8" (34mm x 104mm), 45° angle, one open side
500-TSC-115	Replacement Thumb Screw

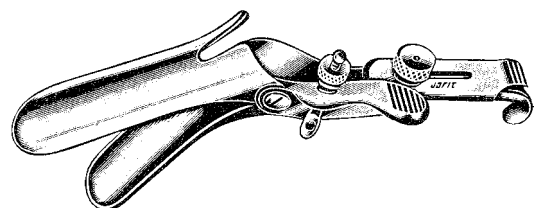

### Cusco Vaginal Specula

swiss pattern

Catalog #	Description
500-137	Small blade: 7/8" x 3 5/8" (22mm x 90mm)
500-138	Medium blade: 1" x 4" (25mm x 100mm)
500-139	Large blade: 1 1/8" x 4 1/8" (27mm x 105mm)

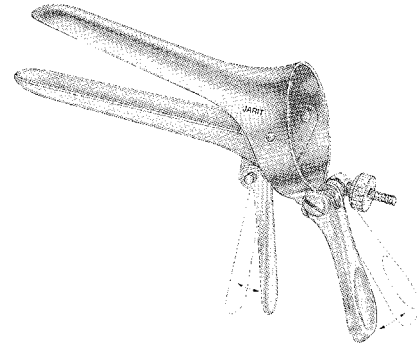

### Cusco Vaginal Specula

Catalog #	Description
500-141	Small blade: 1 1/4" x 3" (32mm x 75mm)
500-142	Medium blade: 1 3/8" x 3 3/8" (35mm x 85mm)
500-143	Large blade: 1 3/8" x 4" (35mm x 100mm)

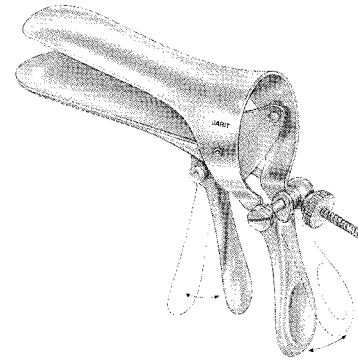

### Auvard Vaginal Specula

2 1/2 lbs.

Catalog #	Description
500-145	Blade: 1 5/8" x 2 3/4" (41mm x 75mm), 45 degree angled blade
500-146	Blade: 1 3/4" x 3 1/4" (44mm x 83mm), 45 degree angled blade
500-147	Blade: 1 3/4" x 4" (46mm x 101mm), 45 degree angled blade

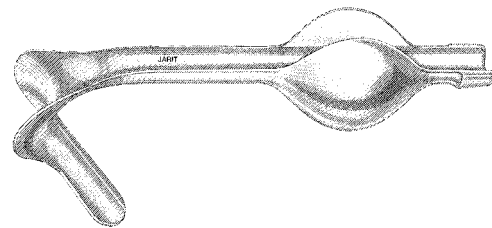

### Steiner-Auvard Vaginal Speculum

2 1/2 lbs.

Catalog #	Description
500-148	Blade 1 3/8" x 5 7/8" (34mm x 150mm), 60 degree angled blade



**O'Sullivan-O'Connor Vaginal Retractor**

Catalog #	Description
500-160	Set includes: 1 retractor ring with 2 fixed blades 3 removable blades
	Removable blades: 500-SBL-160 500-MBL-160 500-LBL-160
500-WGN-160	Replacement Wing Nut pkg/3ea
500-BLD-160	Replacement Set of 3 Blades

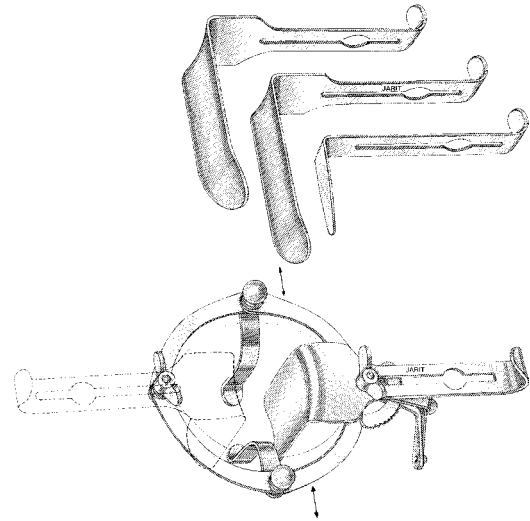

**Jackson Vaginal Retractors**

6 3/4" (172mm)

Catalog #	Description
500-162	Blade: 1 1/2" x 3" deep (39mm x 76mm)
500-163	Blade: 1 1/2" x 3 1/2" deep (39mm x 90mm)
500-164	Blade: 1 1/2" x 4" deep (39mm x 101mm)

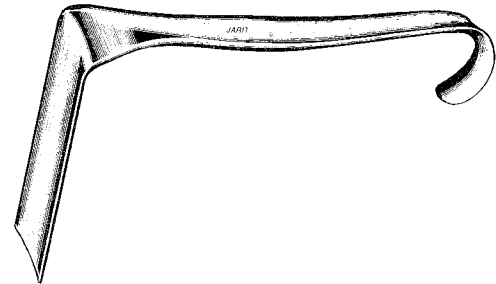

**Eastman Vaginal Retractors**

7" (178mm)

Catalog #	Description
500-166	Blade: 1 1/2" x 3 1/8" deep (39mm x 80mm)
500-167	Blade: 1 1/2" x 3 1/2" deep (39mm x 90mm)
500-168	Blade: 1 1/2" x 4" deep (39mm x 101mm)

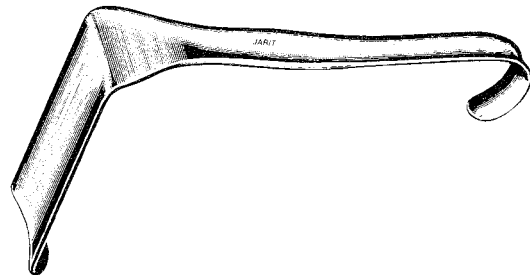

**Murphy Gall Bladder Retractor**

Catalog #	Description
475-429	10" (254mm), blade 2" wide (50mm)

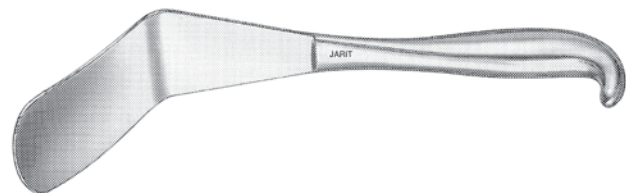



### Doyen Vaginal Retractors

8<sup>7</sup>/<sub>8</sub>" (225mm)

Catalog #	Description
200-145	Blade: 1 <sup>3</sup> / <sub>4</sub> " x 2 <sup>1</sup> / <sub>2</sub> " deep (44mm x 64mm)
200-147	Blade: 2 <sup>1</sup> / <sub>8</sub> " x 3" deep (54mm x 76mm)
200-149	Blade: 2 <sup>1</sup> / <sub>4</sub> " x 3 <sup>1</sup> / <sub>2</sub> " deep (57mm x 89mm)

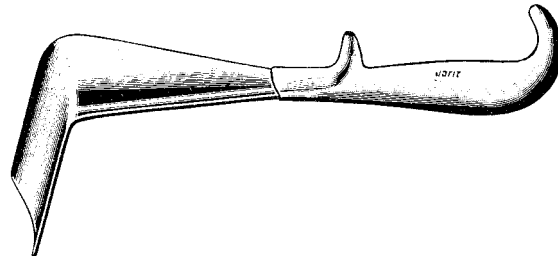

### Sims Vaginal Retractors

double-ended

Catalog #	Description
500-170	6 <sup>1</sup> / <sub>2</sub> " (165mm), blades 7 <sup>7</sup> / <sub>8</sub> " x 2 <sup>1</sup> / <sub>2</sub> " deep (22mm x 64mm) and 1" x 3" deep (25mm x 76mm)
500-171	6 <sup>1</sup> / <sub>2</sub> " (165mm), blades 1" x 2 <sup>1</sup> / <sub>2</sub> " deep (25mm x 64mm) and 1 <sup>1</sup> / <sub>8</sub> " x 3" deep (30mm x 76mm)
500-172	6 <sup>1</sup> / <sub>2</sub> " (167mm), blades 1" x 3 <sup>1</sup> / <sub>8</sub> " deep (25mm x 80mm) and 1 <sup>1</sup> / <sub>4</sub> " x 3 <sup>3</sup> / <sub>8</sub> " deep (32mm x 87mm)
500-173	7 1 <sup>1</sup> / <sub>2</sub> " (190mm), blades 1 <sup>1</sup> / <sub>8</sub> " x 3" deep (29mm x 76mm) and 1 <sup>3</sup> / <sub>8</sub> " x 3 <sup>1</sup> / <sub>4</sub> " deep (34mm x 82mm)
500-174	7 <sup>3</sup> / <sub>4</sub> " (200mm), blades 1 <sup>1</sup> / <sub>4</sub> " x 3 <sup>1</sup> / <sub>4</sub> " deep (32mm x 82mm) and 1 <sup>1</sup> / <sub>2</sub> " x 4" deep (38mm x 102mm)
500-175	7 <sup>1</sup> / <sub>2</sub> " (190mm), blades 1 <sup>3</sup> / <sub>8</sub> " x 3 <sup>1</sup> / <sub>8</sub> " deep (35mm x 80mm) and 1 <sup>5</sup> / <sub>8</sub> " x 3 <sup>7</sup> / <sub>8</sub> " deep (41mm x 100mm)

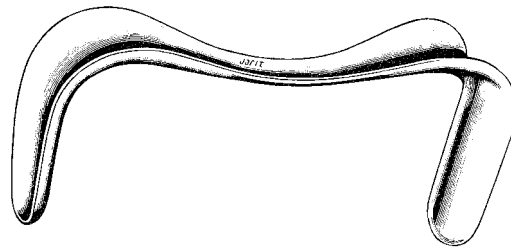

### Sims Vaginal Retractors

single-ended

Catalog #	Description
500-180	7 <sup>1</sup> / <sub>2</sub> " (190mm), blade 1 <sup>1</sup> / <sub>8</sub> " x 2 <sup>3</sup> / <sub>4</sub> " deep (30mm x 70mm)
500-181	8 <sup>1</sup> / <sub>4</sub> " (210mm), blade 1 <sup>1</sup> / <sub>4</sub> " x 3" deep (32mm x 75mm)
500-182	8 <sup>3</sup> / <sub>4</sub> " (220mm), blade 1 <sup>1</sup> / <sub>2</sub> " x 3 <sup>1</sup> / <sub>2</sub> " deep (37mm x 88mm)

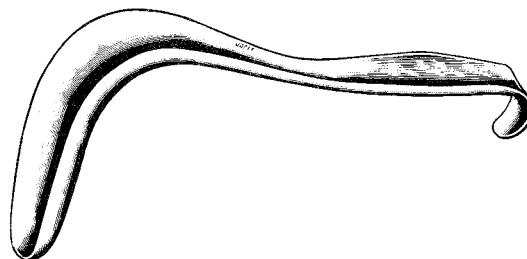

**Sims Vaginal Retractors**

hollow grip handle

Catalog #	Description
500-184	8 3/4" (220mm), blade 1" x 2 7/8" deep (25mm x 72mm)
500-185	8 3/4" (225mm), blade 1 1/8" x 3" deep (30mm x 77mm)
500-186	9" (230mm), blade 1 3/8" x 3 1/2" deep (36mm x 89mm)

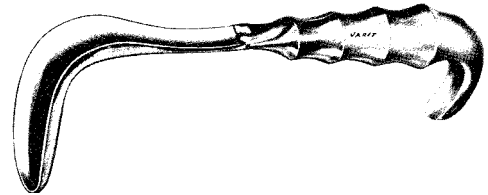

**Heaney Hysterectomy Retractors**

10 1/2" (267mm)

Catalog #	Description
500-190	blade 1 1/8" x 1 7/8" deep (29mm x 47mm)
500-191	blade 1 1/8" x 3" deep (29mm x 75mm)
500-192	blade 1 1/8" x 3 3/8" deep (29mm x 85mm)

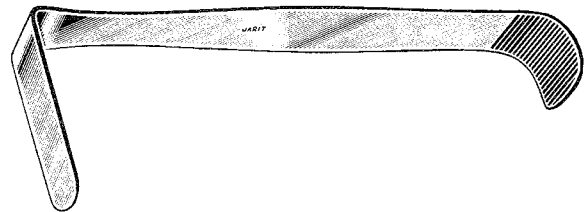

**Heaney-Simon Hysterectomy Retractor**

10 3/4" (273mm)

Catalog #	Description
500-195	blade 1 1/8" x 4 5/8" (28mm x 117mm)

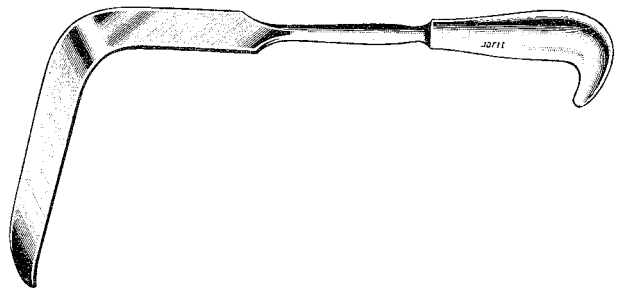

**Delee Universal Retractor**

9 1/2" (241mm)

Catalog #	Description
500-197	blade 3" x 2 1/8" (75mm x 54mm)

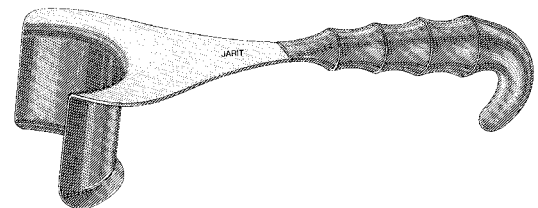

**Hegar Uterine Dilators**

double-ended, 8" (203mm)

Catalog #	Description
500-200	Set of 8, sizes 3mm through 18mm, in canvas roll
500-201	Sizes 1-2mm
500-202	Sizes 3-4mm
500-203	Sizes 5-6mm
500-204	Sizes 7-8mm
500-205	Sizes 9-10mm
500-206	Sizes 11-12mm
500-207	Sizes 13-14mm
500-208	Sizes 15-16mm
500-209	Sizes 17-18mm

500-CVB-200 Canvas Roll for Dilator Set



**Hegar Uterine Dilators**

single-ended, 7½" (185mm), 1mm to 26mm, 26 sizes

Catalog #	Description
500-215	Set of 26, sizes 1mm through 26mm, (whole sizes only) in canvas roll
500-400	1mm
500-401	1.5mm
500-402	2mm
500-403	2.5mm
500-404	3mm
500-405	3.5mm
500-406	4mm
500-407	4.5mm
500-408	5mm
500-409	5.5mm
500-410	6mm
500-411	6.5mm
500-412	7mm
500-413	7.5mm
500-414	8mm
500-415	8.5mm
500-416	9mm
500-417	9.5mm
500-418	10mm
500-419	10.5mm
500-420	11mm
500-421	11.5mm
500-422	12mm
500-423	12.5mm
500-424	13mm
500-425	13.5mm
500-426	14mm
500-427	14.5mm
500-428	15mm
500-429	15.5mm
500-430	16mm
500-431	16.5mm
500-432	17mm
500-433	17.5mm
500-434	18mm
500-435	18.5mm
500-436	19mm
500-437	20mm
500-438	21mm
500-439	22mm
500-440	23mm
500-441	24mm
500-442	25mm
500-443	26mm

500-CVB-215 Canvas Roll for Dilator Set



### Hank Uterine Dilators

double-ended, 10<sup>3</sup>/<sub>4</sub>" (270mm)

Catalog #	Description
500-230	Set of 6, sizes 9 French (4.5mm) through 20 French (10mm), in canvas roll
500-232	Sizes 9-10 French (4.5mm-5mm)
500-233	Sizes 11-12 French (5.5mm-6mm)
500-234	Sizes 13-14 French (6.5mm-7mm)
500-235	Sizes 15-16 French (7.5mm-8mm)
500-236	Sizes 17-18 French (8.5mm-9mm)
500-237	Sizes 19-20 French (9.5mm-10mm)

500-CVB-230 Canvas Roll for Hank Dilator Set



### Pratt Uterine Dilators

double-ended, 10" (255mm)

Catalog #	Description
500-240	Set of 8, sizes 13 French (4.3mm) through 43 French (14.2mm), in canvas roll
500-241	Sizes 13-15 French (4.3mm-4.6mm)
500-242	Sizes 17-19 French (5.6mm-6.3mm)
500-243	Sizes 21-23 French (7mm-7.6mm)
500-244	Sizes 25-27 French (8.3mm-9mm)
500-245	Sizes 29-31 French (9.6mm-10.2mm)
500-246	Sizes 33-35 French (10.9mm-11.6mm)
500-247	Sizes 37-39 French (12.2mm-12.9mm)
500-248	Sizes 41-43 French (13.5mm-14.2mm)

500-CVB-240 Canvas Roll for Dilator Set



### Sims Uterine Sounds

13<sup>1</sup>/<sub>2</sub>" (343mm), silver plated

Catalog #	Description
500-250	Graduated in inches
500-252	Graduated in centimeters



### Simpson Uterine Sounds

13½" (343mm), silver plated

Catalog #	Description
500-256	Graduated in inches
500-258	Graduated in centimeters

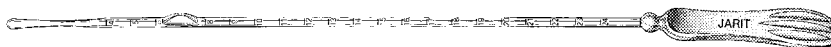

### Kogan Endocervical Speculum

9⅝" (245mm)

Catalog #	Description
500-265	5.5mm x 24mm ring tips, with gauge and set screws

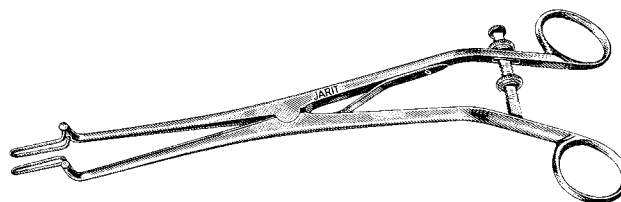

### Somers Uterine Elevating Forceps

8¾" (223mm)

Catalog #	Description
500-270	32mm wide curved jaws, 32mm long serrations

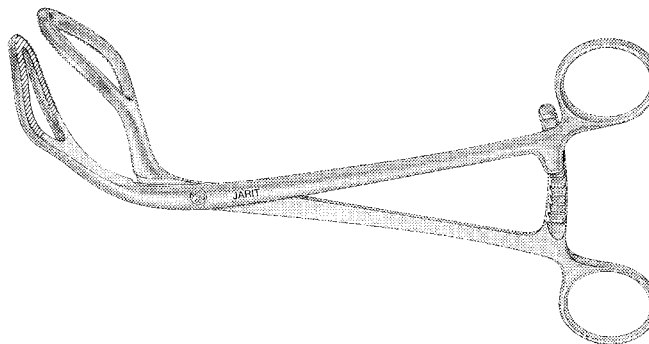

**Hunter Uterine Curette**

Catalog #	Description
500-295	12 1/4" (314mm), 30mm wide loop

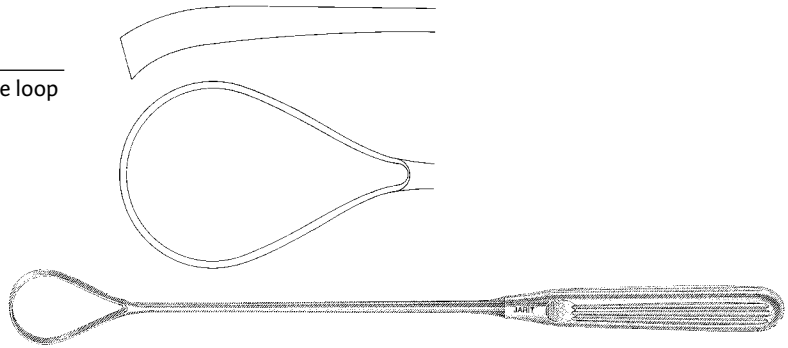

**Sims Uterine Curettes**

11" (280mm), sharp blade, malleable shaft

Catalog #	Description
500-298	Size 000: 4mm wide loop
500-299	Size 00: 5mm wide loop
500-300	Size 0: 6mm wide loop
500-301	Size 1: 7mm wide loop
500-302	Size 2: 8mm wide loop
500-303	Size 3: 9mm wide loop
500-304	Size 4: 10mm wide loop
500-305	Size 5: 11mm wide loop
500-306	Size 6: 12mm wide loop

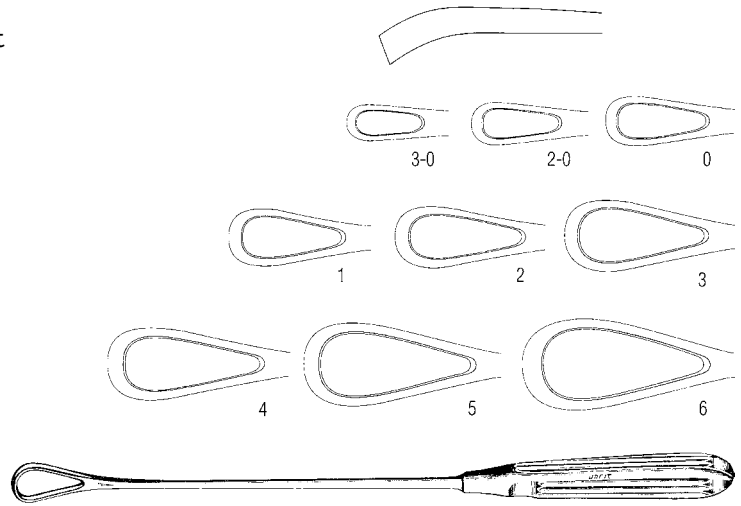

**Thomas Uterine Curettes**

11" (280mm), blunt blade, malleable shaft

Catalog #	Description
500-310	Size 0: 6mm wide loop
500-311	Size 1: 7mm wide loop
500-312	Size 2: 8mm wide loop
500-313	Size 3: 9mm wide loop
500-314	Size 4: 10mm wide loop
500-315	Size 5: 11mm wide loop
500-316	Size 6: 12mm wide loop

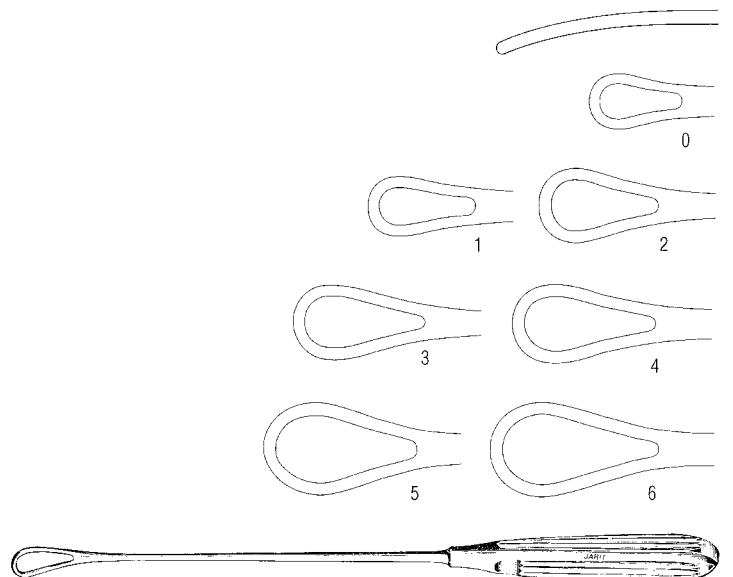

**Heaney Uterine Biopsy Curette**

9¾" (247mm)

Catalog #	Description
500-320	Serrated loop, 6mm wide x 10mm long



**Randall Endometrial Biopsy Suction Curette**

9¾" (247mm)

Catalog #	Description
500-325	4mm diameter, with Luer hub



**Novak Endometrial Biopsy Suction Curettes**

9¼" (235mm) working length, with luer hub

Catalog #	Description
500-330	4mm diameter
500-331	2mm diameter

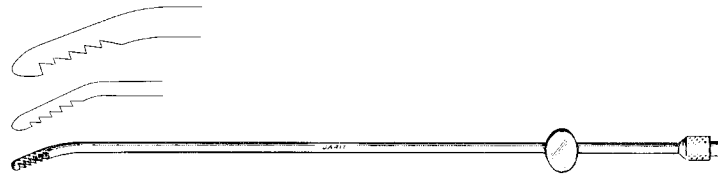

**Kevorkian-Younger Endocervical Biopsy Curettes**

12¼" (310mm), 2mm x 12mm loop

Catalog #	Description
500-335	without specimen basket
500-336	with specimen basket

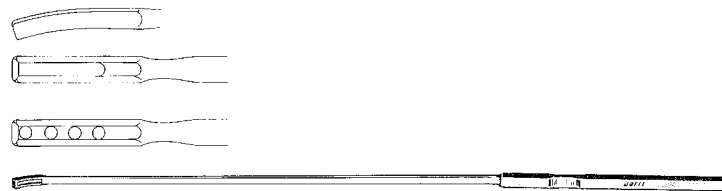

**Duncan Endometrial Biopsy Curettes**

11½" (290mm)

Catalog #	Description
500-337	2.5mm x 10mm loop



**Townsend Endocervical Biopsy Curette**

12 3/4" (310mm)

Catalog #	Description
500-340	1.5mm x 7mm loop



**Thomas-Gaylor Biopsy Forceps**

9 1/4" (234mm), S-shaped, screw lock

Catalog #	Description
505-100	5.5mm interfitted cups

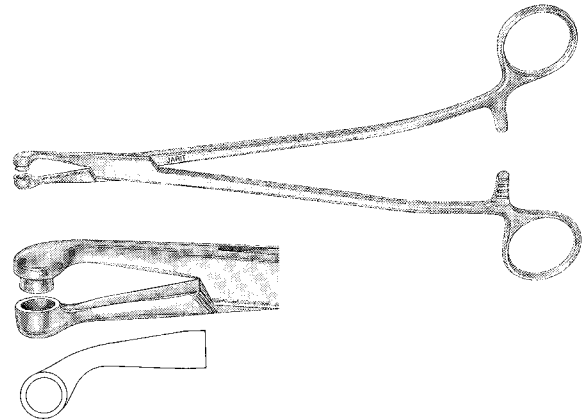

**Thomas-Gaylor Biopsy Forceps**

8 1/2" (215mm), curved jaws, straight handle

Catalog #	Description
505-105	5.5mm interfitted cups

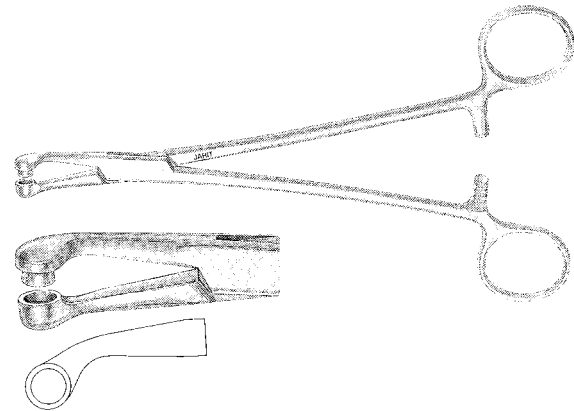

**Wittner Biopsy Forceps**

9" (230mm) working length, 4mm x 8mm bite

Catalog #	Description
505-110	Curved jaws with teeth
505-115	Straight jaws with teeth

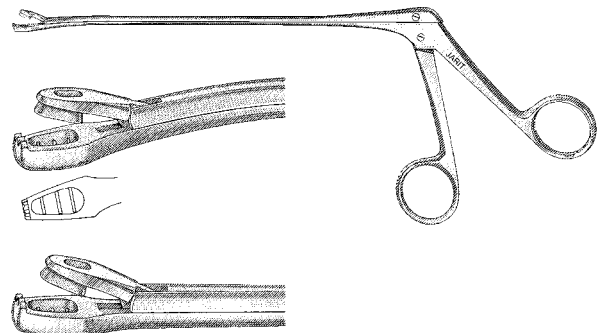



**Eppendorfer Biopsy Forceps**

8 1/4" (210mm) working length

Catalog #	Description
505-116	4.4mm x 8.5mm bite

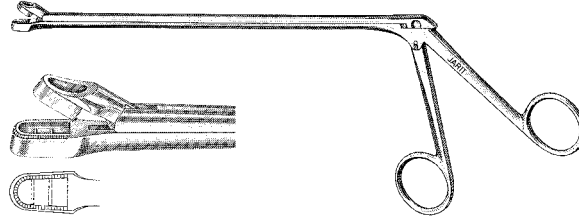

**Schubert Biopsy Forceps**

11" (279mm), straight shanks

Catalog #	Description
505-120	5mm x 8.6mm bite

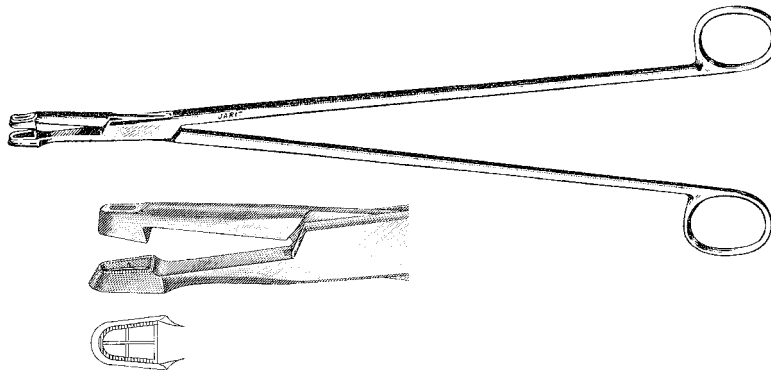

**Schubert Biopsy Forceps**

11" (279mm), angled shanks

Catalog #	Description
505-125	5mm x 8.6mm bite

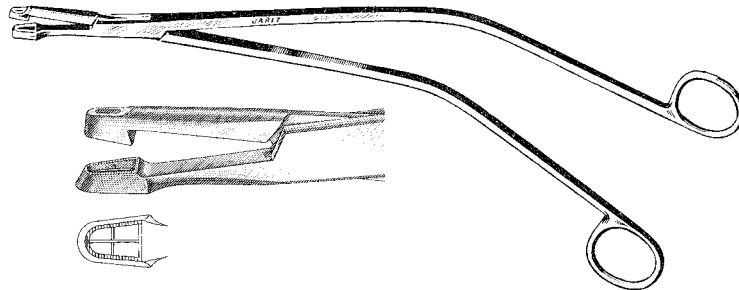

**Hartman Biopsy Forceps**

7" (178mm) working length

Catalog #	Description
505-135	7mm round blade

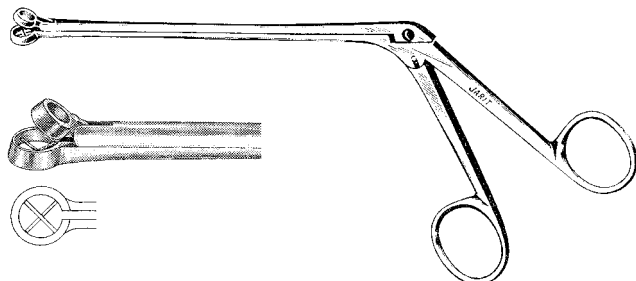

**Kevorkian-Younger Biopsy Forceps**

9¾" (245mm) working length

Catalog #	Description
505-140	3mm x 10mm bite

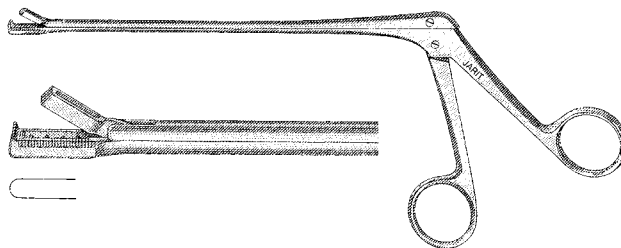

**Burke Cervical Biopsy Punch**

7¾" (195mm) working length

Catalog #	Description
505-144	3mm x 4.8mm bite



**Tischler Biopsy Forceps**

Catalog #	Description
505-145	9" (230mm) working length, pointed jaws, 3mm x 8mm bite

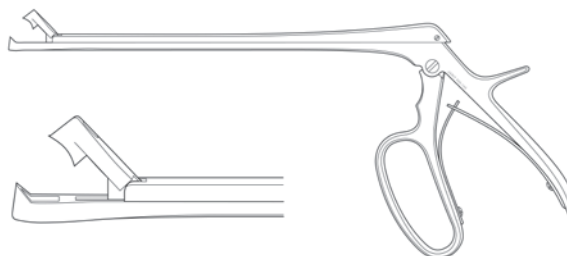

505-146	8½" (215mm) working length, improved model, rounded jaws, controls thickness of specimen, 3mm x 7mm bite
---------	--



**Tischler Biopsy Forceps**

11" (280mm), pointed jaws

Catalog #	Description
505-150	4mm x 8mm bite

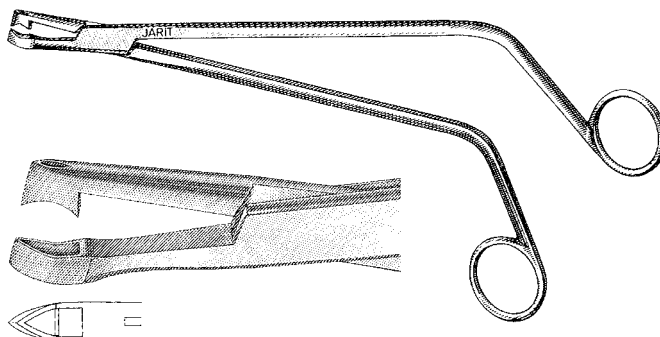

### Bozeman Uterine Dressing Forceps

10" (254mm)

Catalog #	Description
505-160	S-shaped
505-162	S-shaped, 1 large ring
505-163	Straight

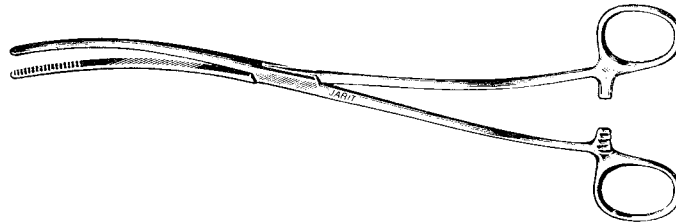

### Laufe Uterine Polyp Forceps

8" (205mm)

Catalog #	Description
505-170	5mm x 15mm curved serrated jaw

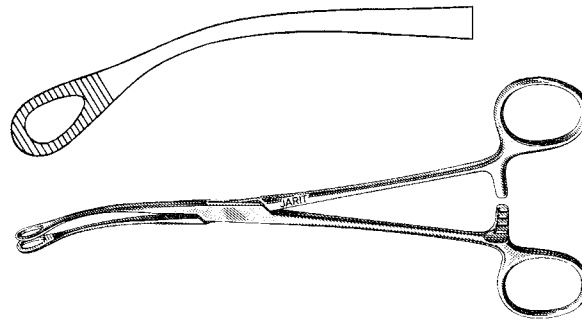

### Overstreet Endometrial Polyp Forceps

9¼" (235mm)

Catalog #	Description
505-175	7mm x 35mm hollow fenestrated jaw

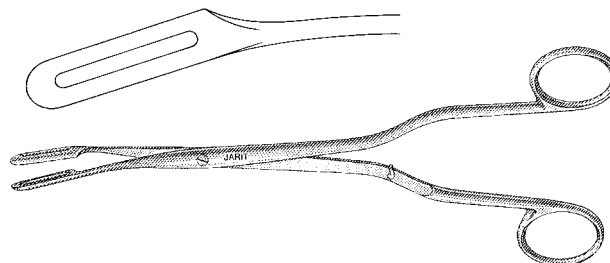

### Fletcher Polyp Forceps

9¾" (245mm)

Catalog #	Description
115-119	Straight
115-120	Curved

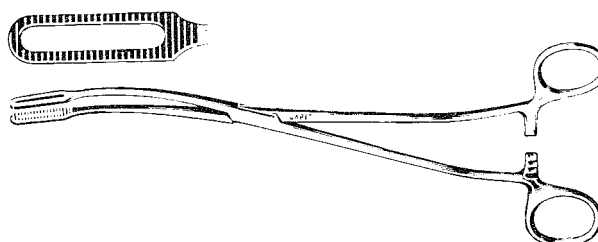

**Schroeder Tenaculum Forceps**

Catalog #	Description
505-200	10" (252mm)

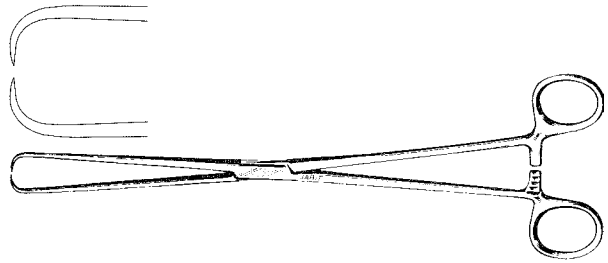

**Braun Tenaculum Forceps**

Catalog #	Description
505-205	10" (254mm)

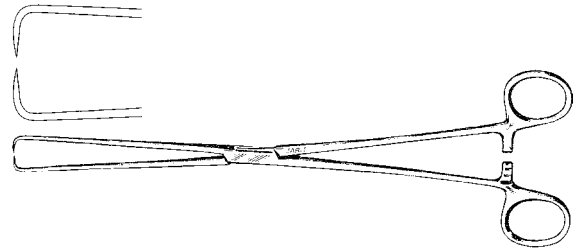

**Duplay Tenaculum Forceps**

Catalog #	Description
505-206	10 <sup>3</sup> / <sub>4</sub> " (275mm), double curved

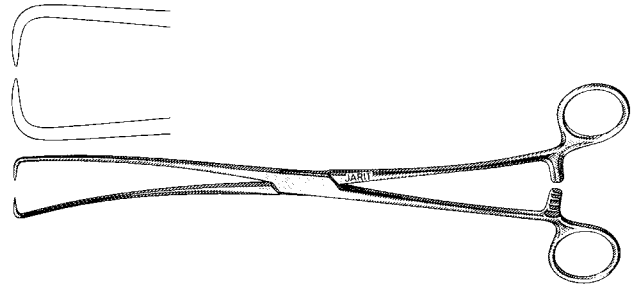

**Barrett Tenaculum Forceps**

Catalog #	Description
505-210	7 <sup>1</sup> / <sub>4</sub> " (185mm)

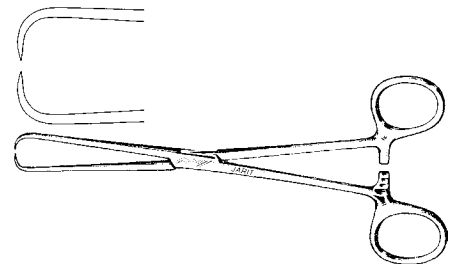

**Staud-Moore Tenaculum Forceps**

Catalog #	Description
505-215	6 <sup>1</sup> / <sub>2</sub> " (165mm)

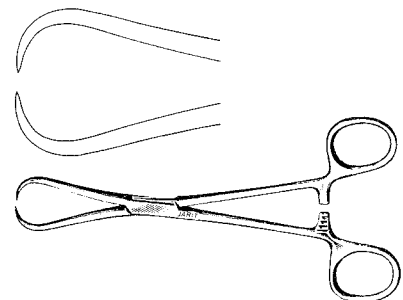

**Skene Tenaculum Forceps**

9 1/4" (236mm)

Catalog #	Description
505-220	Curved to one side

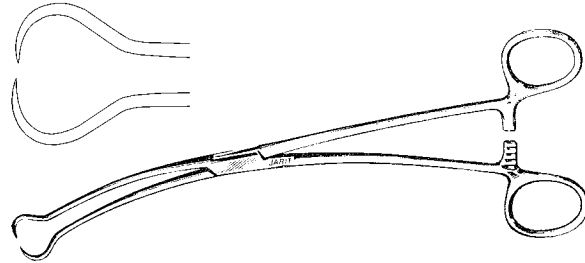

**Hulka Tenaculum Forceps**

11" (278mm)

Catalog #	Description
505-225	3.5mm probe tip and single tooth

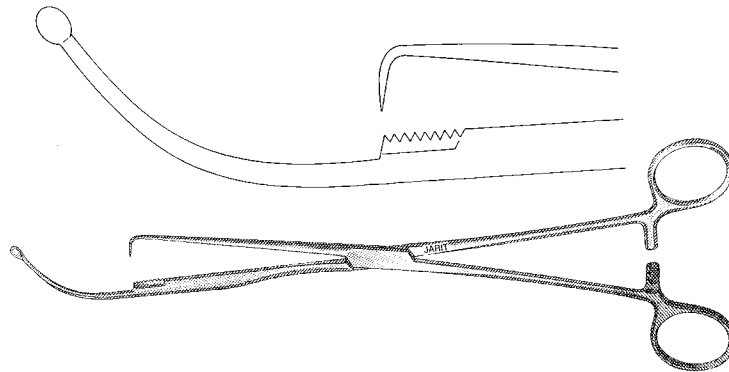

**Cohen Acorn Cannula**

Catalog #	Description
505-230	10 1/4" (260mm) intrauterine probe, spring mounted forceps holder with small and large cervical cones
505-231	Small cervical cone 3.2mm x 18.7mm x 55mm for 505-230
505-232	Large cervical cone 3.2mm x 25mm x 55mm for 505-230
505-SPR-230	Replacement Spring

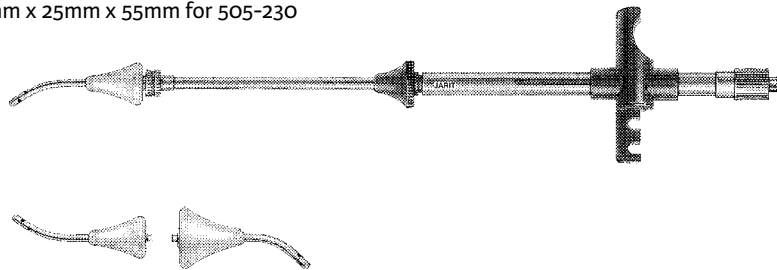

**Schroeder Uterine Vulsellum Forceps**

9 1/2" (250mm), 10mm wide x 18mm long, 2 x 2 teeth

Catalog #	Description
505-240	Straight

505-241	Curved on flat
---------	----------------

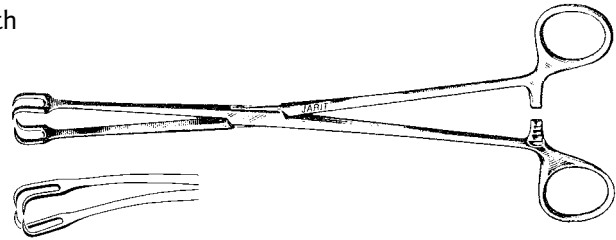

**Teale Uterine Vulsellum Forceps**

11 1/4" (245mm)

Catalog #	Description
505-245	6.2mm 3 x 4 teeth, curved to side

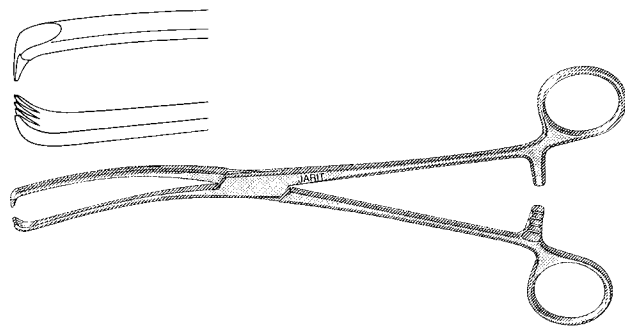

**Gordon Uterine Vulsellum Forceps**

8 3/4" (220mm)

Catalog #	Description
505-246	9.3mm 3 x 3 teeth, straight

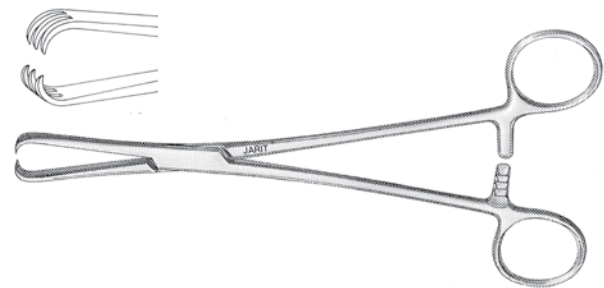

**Jacobs Uterine Vulsellum Forceps**

8 1/2" (215mm), 7mm 2 x 2 teeth

Catalog #	Description
505-250	Straight

505-252	Curved to side
---------	----------------

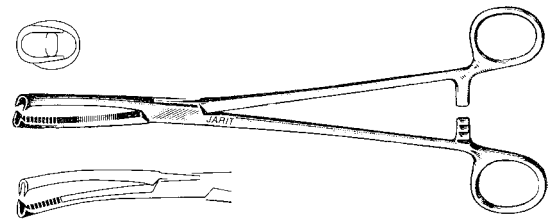

**Henrotin Uterine Vulsellum Forceps**

8 1/2" (215mm)

Catalog #	Description
505-255	7mm 2 x 3 teeth

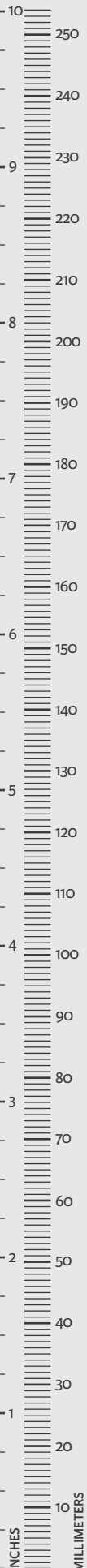
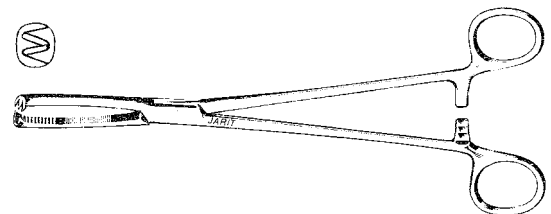

### Emmett Uterine Tenaculum Hooks

8<sup>5</sup>/<sub>8</sub>" (220mm)

Catalog #	Description
505-260	Style 1: 1/2 curved
505-261	Style 2: 3/4 curved
505-262	Style 3: right angled
505-263	Style 4: acute angled
505-264	Style 5: double angled

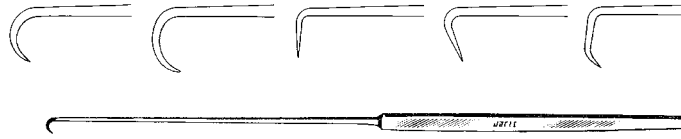

### Parametrium Scissors, Carb-Edge

Catalog #	Description
505-265	9" (226mm), slight curve, 81mm blades
505-266	8 <sup>3</sup> / <sub>4</sub> " (224mm), curve, 78mm blades
505-267	8 <sup>1</sup> / <sub>2</sub> " (219mm), full curve, 76mm blades
505-268	10 <sup>1</sup> / <sub>2</sub> " (267mm), slight curve, 81mm blades
505-269	10 <sup>1</sup> / <sub>4</sub> " (260mm), curve, 78mm blades
505-270	10" (255mm), full curve, 76mm blades
505-271	12" (305mm), slight curve, 81mm blades
505-272	11 <sup>3</sup> / <sub>4</sub> " (300mm), curve, 78mm blades
505-273	11 <sup>1</sup> / <sub>2</sub> " (295mm), full curve, 76mm blades

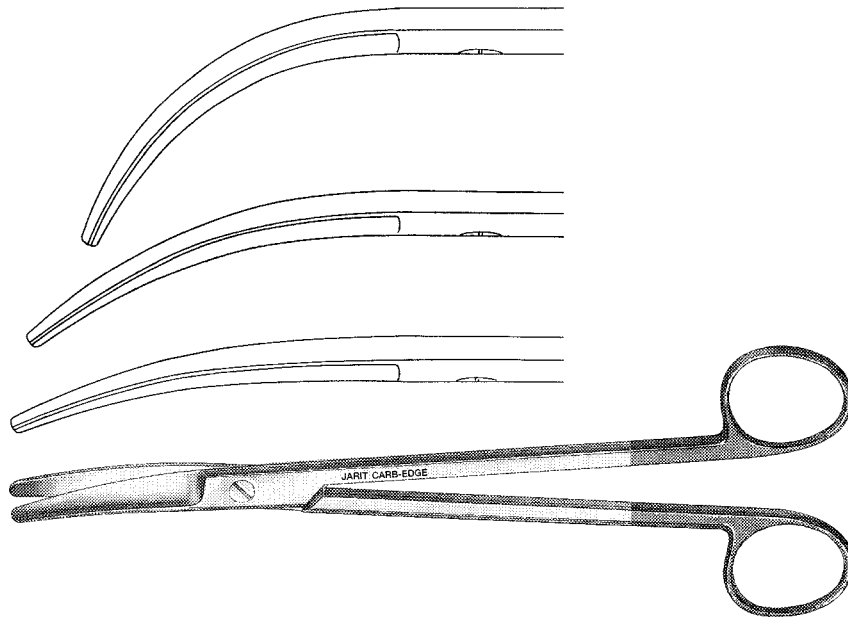

**Z-Hysterectomy Forceps**  
Flared Shanks

Catalog #	Description
505-280	8½" (219mm), straight
505-281	8½" (219mm), slight curve
505-282	8½" (219mm), curved
505-283	8¼" (207mm), angle
505-284	10" (251mm), straight
505-285	10" (252mm), slight curve
505-286	9¾" (246mm), curved
505-287	9½" (239mm), angle
505-288	12¼" (310mm), straight
505-289	12¼" (309mm), slight curve
505-290	11¾" (301mm), curved
505-291	11¾" (297mm), angle
505-292	14¼" (363mm), straight
505-293	14½" (365mm), slight curve
505-294	14½" (367mm), curved
505-295	13¾" (352mm), angle

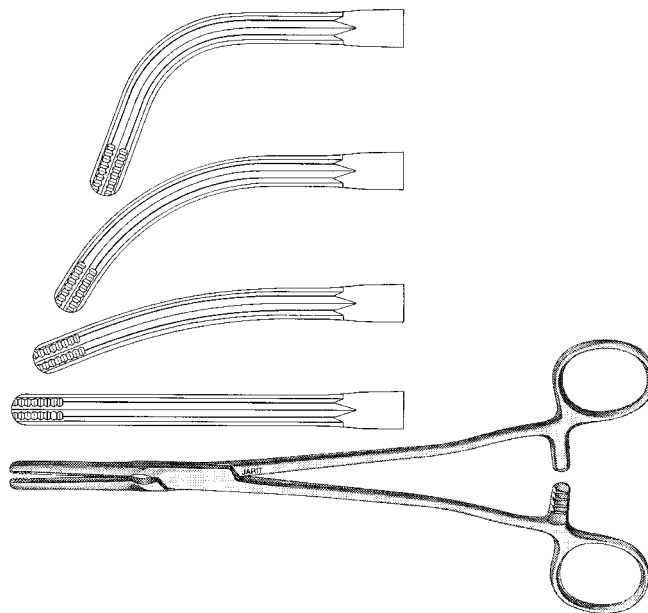

**Heaney Hysterectomy Forceps**  
8¼" (210mm), curved, single tooth

Catalog #	Description
505-300	Light pattern
505-305	Heavy pattern

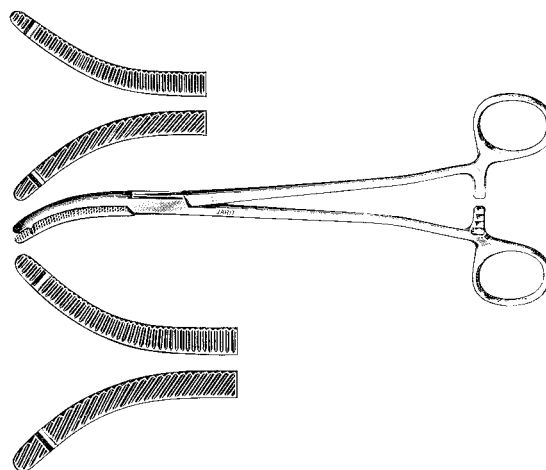

**Heaney Hysterectomy Forceps**  
8½" (215mm)

Catalog #	Description
505-310	Curved, double tooth, heavy pattern

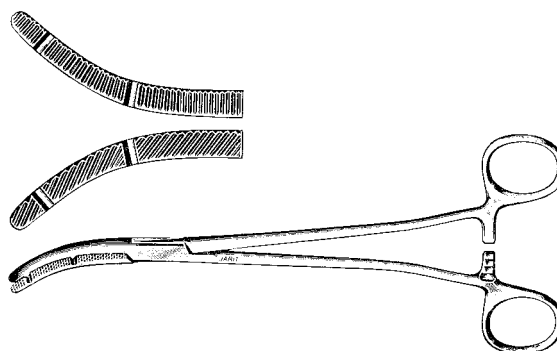



**Heaney-Rezek Hysterectomy Forceps**

8½" (215mm)

Catalog #	Description
505-315	8½" (213mm), straight, single tooth, cross-serrated

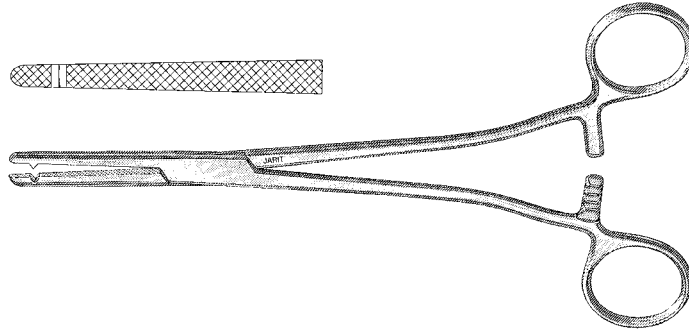

**Heaney-Ballentine Hysterectomy Forceps**

longitudinal grooves

Catalog #	Description
505-319	8½" (213mm), straight
505-320	8¼" (210mm), curved
505-312	10½" (270mm), curved
505-313	10½" (270mm), straight
505-314	11¾" (300mm), curved
505-316	11¾" (300mm), straight
505-317	13¾" (350mm), curved
505-318	13¾" (350mm), straight

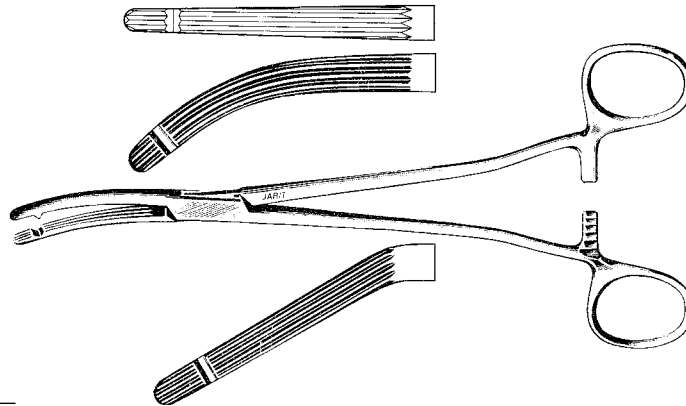

**Garland Hysterectomy Forceps**

8¼" (207mm)

Catalog #	Description
505-330	Angled on flat, longitudinal grooves

**Heaney Hysterectomy Forceps**  
Cardio-Grip serrations

Catalog #	Description
505-321	9" (229mm), straight
505-322	8¾" (222mm), Curved

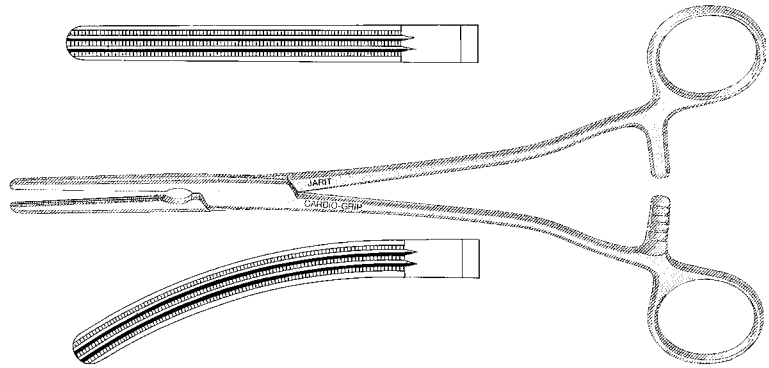

**Masterson Hysterectomy Forceps**  
8½" (215mm), Cardio-Grip serrations

Catalog #	Description
505-325	Straight
505-326	Curved

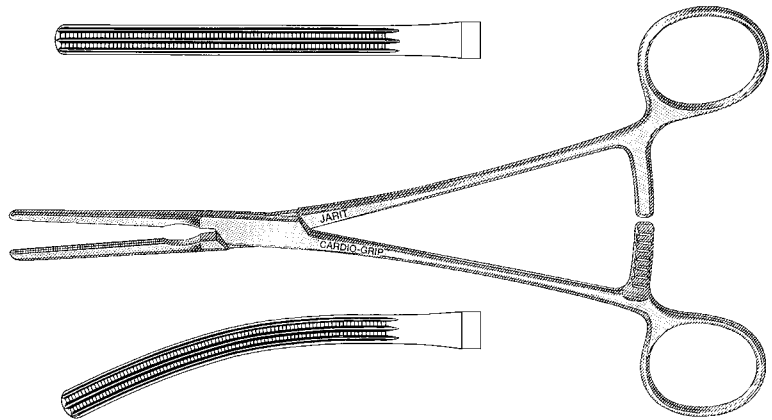

### Rogers Hysterectomy Clamps

10½" (268mm), Cardio-Grip serrations

Catalog #	Description
505-327	Straight
505-328	Curved

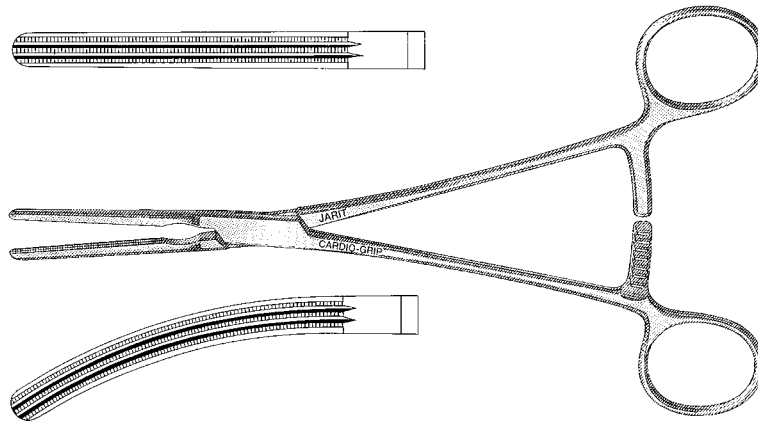

### Long Hysterectomy Forceps

8" (201mm)

Catalog #	Description
505-335	1 x 2 teeth, longitudinal grooves

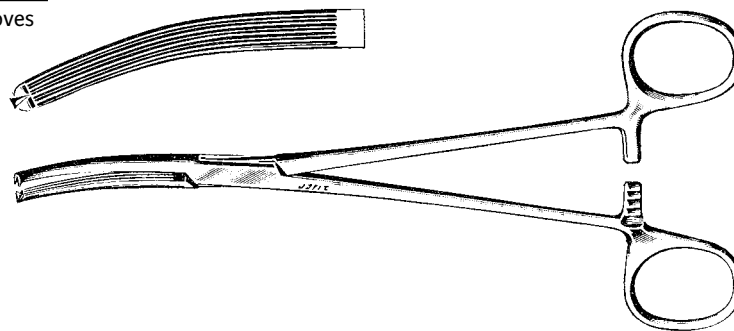

### Phaneuf Uterine Artery Forceps

8" (203mm)

Catalog #	Description
505-340	Straight
505-345	Angled on flat

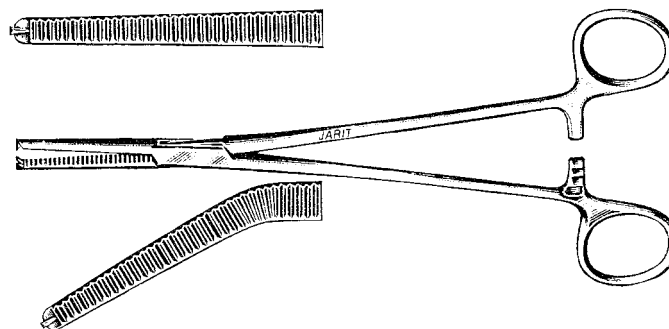

**Billroth Tumor Forceps**

11" (280mm)

Catalog #	Description
505-360	4-sharp prongs, 20mm wide x 23mm length

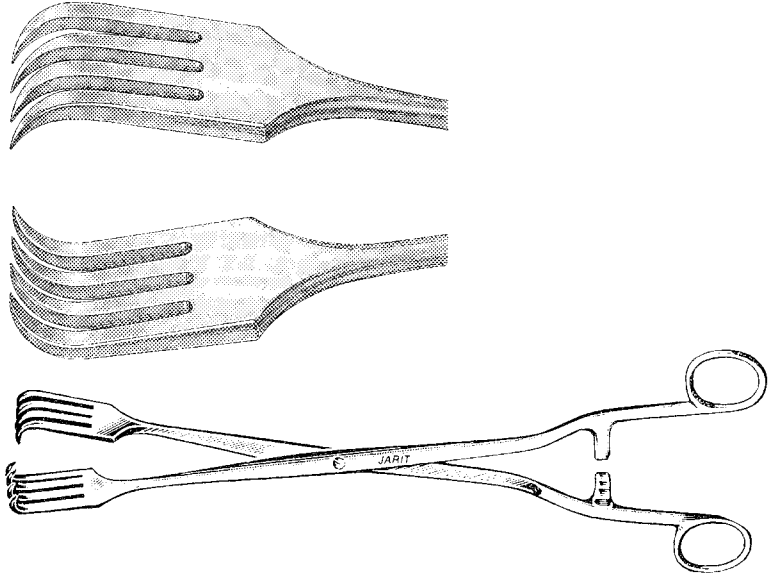

**Doyen Tumor Screw**

6¾" (170mm)

Catalog #	Description
505-365	24mm diameter

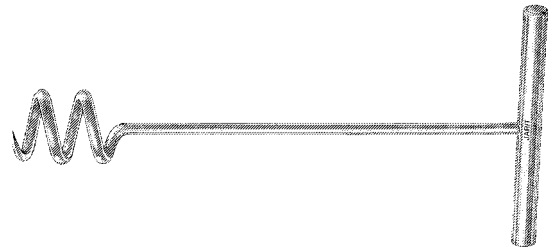

**Rochester-Pean Artery Forceps, (Mirror Finish)**

Manufactured from high grade German surgical stainless steel which is ground and polished to a mirror finish

Catalog #	Description
105-190	8" (203mm), straight
105-191	8" (203mm), curved
105-195	8¾" (221mm), straight
105-196	8¾" (221mm), curved
105-197	10" (254mm), straight
105-198	11" (279mm), straight
105-199	12" (305mm), straight

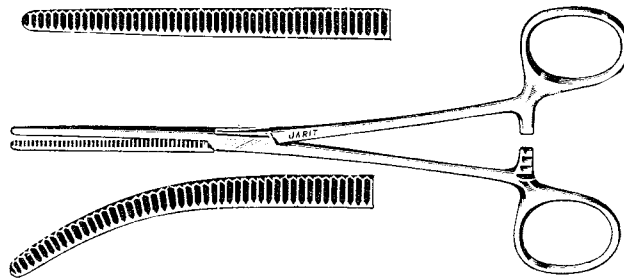

**Rochester-Pean Artery Forceps, (Satin Finish)**

Manufactured from high grade German surgical stainless steel which is ground and polished to a satin finish

Catalog #	Description
106-190	8" (203mm), straight
106-191	8" (203mm), curved
106-195	8¾" (221mm), straight
106-196	8¾" (221mm), curved

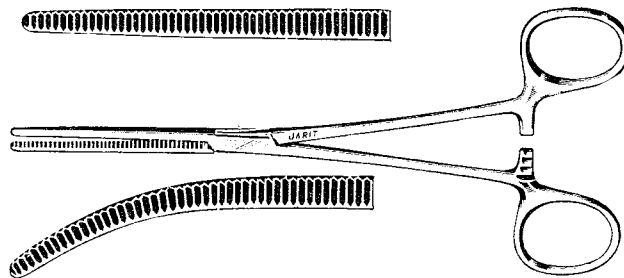

**Rochester-Pean Artery Forceps, (Matte Finish)**

Manufactured from high grade German surgical stainless steel which is glass beaded to a matte finish

Catalog #	Description
107-190	8" (203mm), straight
107-191	8" (203mm), curved

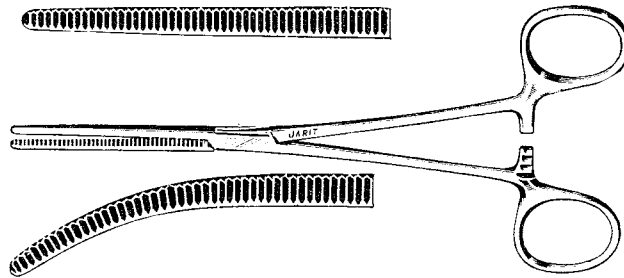

**Rochester-Ochsner Artery Forceps, (Mirror Finish)**

Manufactured from high grade German surgical stainless steel which is ground and polished to a mirror finish

Catalog #	Description
105-210	7¼" (184mm), straight
105-212	7¼" (184mm), curved
105-220	7¾" (200mm), straight
105-222	7¾" (200mm), curved
105-223	8¾" (225mm), straight
105-224	8¾" (225mm), curved
105-225	10½" (265mm), straight
105-226	10½" (265mm), curved
105-227	11" (279mm), straight
105-229	12" (305mm), straight
105-228	14" (356mm), straight

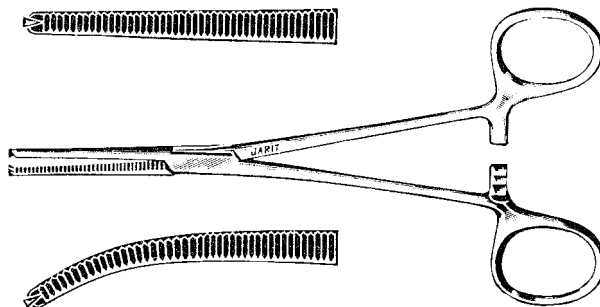

**Rochester-Ochsner Artery Forceps, (Satin Finish)**

Manufactured from high grade German surgical stainless steel which is ground and polished to a satin finish

Catalog #	Description
106-210	7¼" (184mm), straight
106-212	7¼" (184mm), curved
106-220	7¾" (200mm), straight
106-222	7¾" (200mm), curved

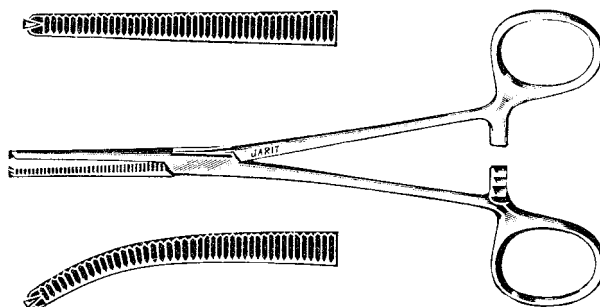

**Rochester-Ochsner Artery Forceps, (Matte Finish)**

Manufactured from high grade German surgical stainless steel which is glass beaded to a matte finish

Catalog #	Description
107-210	7¼" (184mm), straight
107-220	7¾" (200mm), straight

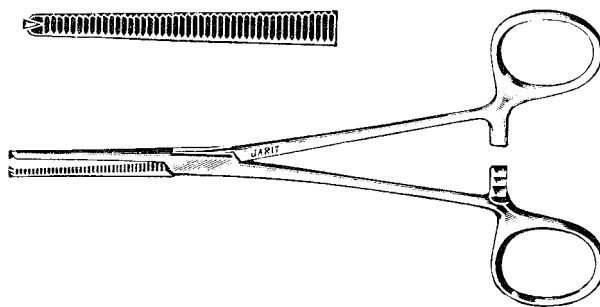

**Sims Uterine Scissors**

8" (203mm), straight

Catalog #	Description
505-400	Sharp-sharp
505-401	Sharp-blunt
505-402	Blunt-blunt

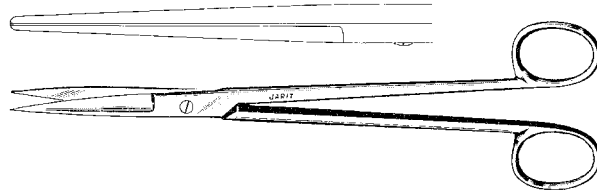

**Sims Uterine Scissors**

7¾" (200mm), curved

Catalog #	Description
505-405	Sharp-sharp
505-406	Sharp-blunt
505-407	Blunt-blunt

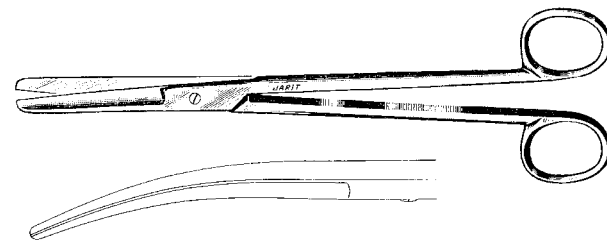

**Kelly Uterine Scissors**

6¼" (158mm)

Catalog #	Description
100-280	Straight
100-281	Curved

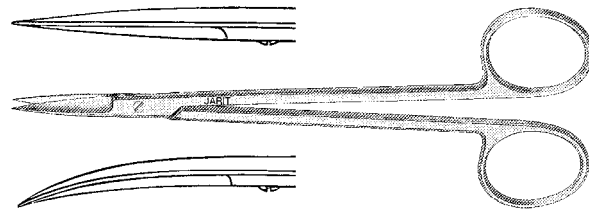

**Mayo Uterine Scissors**

9" (230mm)

Catalog #	Description
305-140	Straight
305-141	Curved

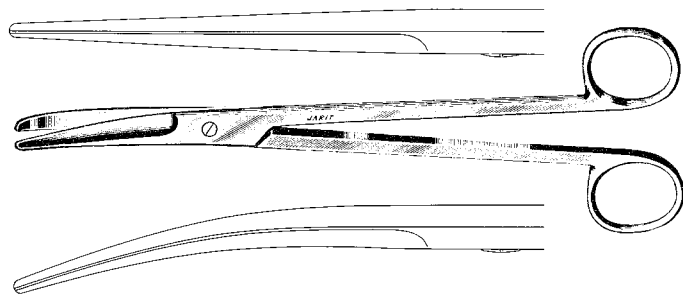

**Mayo-Harrington Scissors, Carb-Edge**

Catalog #	Description
101-225	9" (230mm), straight
101-226	9" (230mm), curved
101-230	14¼" (361mm), straight
101-232	14¼" (361mm), curved

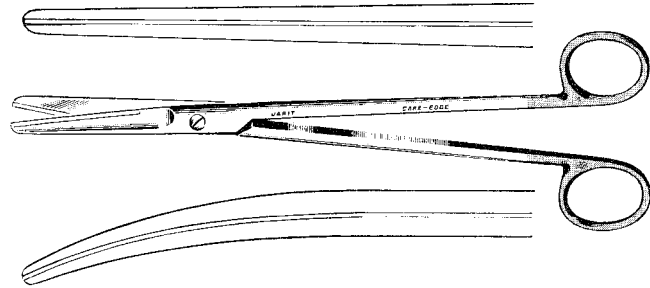

**Mayo Scissors, Supercut™**

Catalog #	Description
102-115	9" (230mm), straight
102-116	9" (230mm), curved
102-118	11" (280mm), curved
102-114	12" (305mm), curved

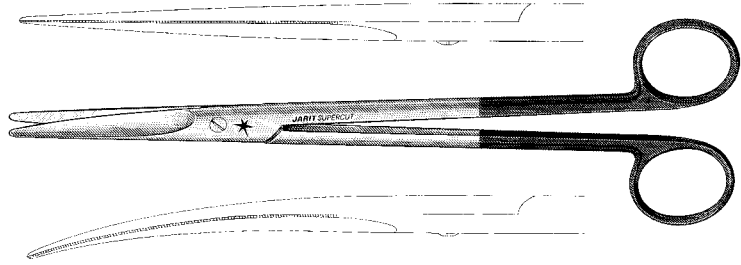

**Ferguson Scissors**

7¼" (184mm)

Catalog #	Description
100-233	Angled on flat

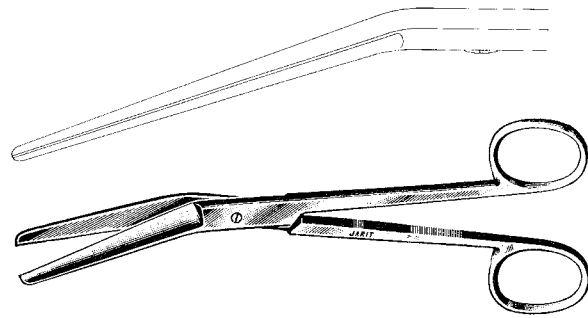

**Braun Episiotomy Scissors**

Catalog #	Description
505-435	5¾" (146mm)
505-436	8¾" (222mm)

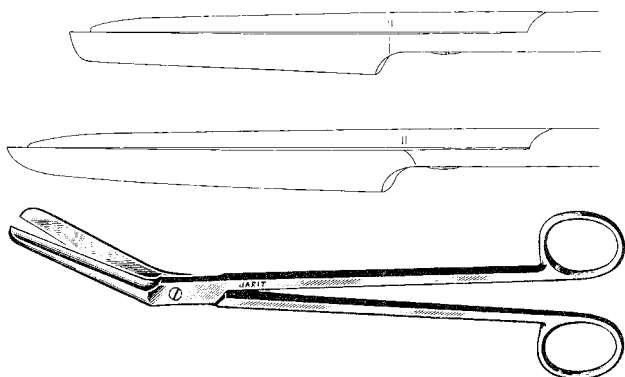



**Iowa Trumpet Pudendal Needle Guide**

5½" (140mm)

Catalog #	Description
510-100	Uses 6" (152mm), 28 gauge needle

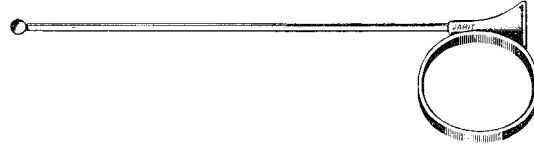

**Iowa Membrane Puncturing Forceps**

10½" (264mm)

Catalog #	Description
510-120	7mm wide, 5mm x 6mm teeth

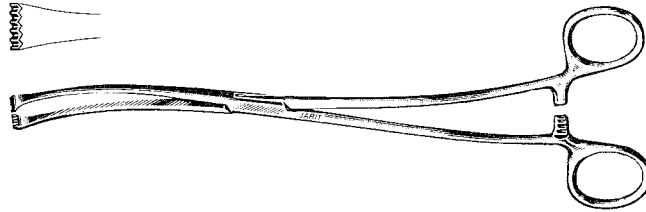

**Martin Pelvimeter**

13½" (340mm)

Catalog #	Description
510-130	Graduated in centimeters and inches

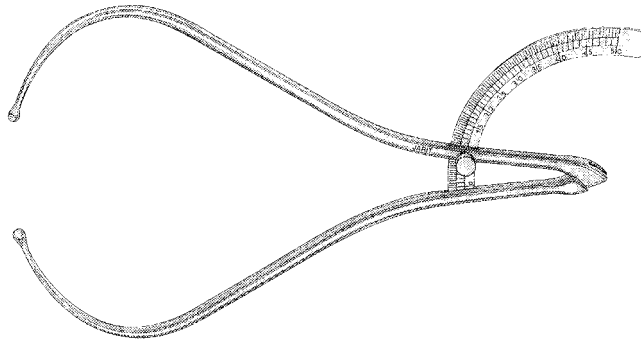

**Kelly Placenta Forceps**

Catalog #	Description
510-140	12½" (318mm)

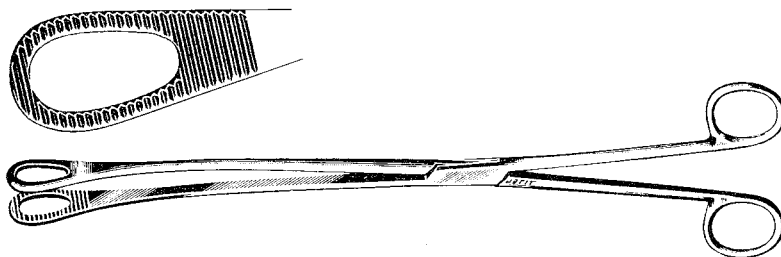

**Barrett Placenta Forceps**

Catalog #	Description
510-145	10¾" (273mm)

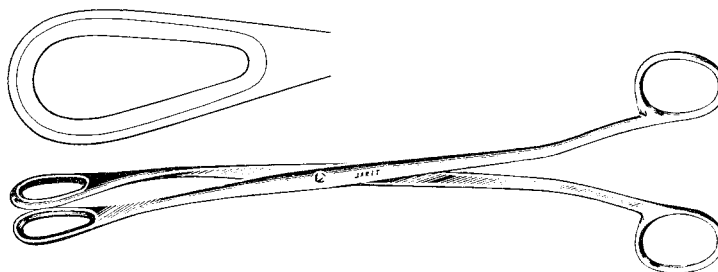

**Umbilical Cord Scissors**

Catalog #	Description
510-155	4⅞" (105mm)

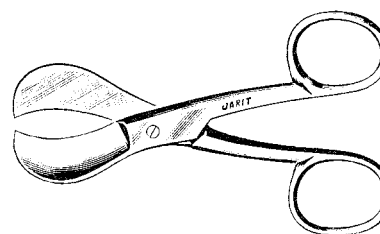

**Zipser Penis Clamp**

Catalog #	Description
510-165	4⅞" (105mm) overall length, 3mm opening for infants

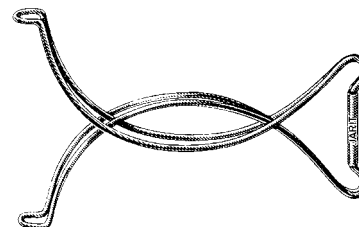

**Delee Obstetrical Forceps**

Catalog #	Description
510-200	12" (305mm)
510-205	14" (355mm)

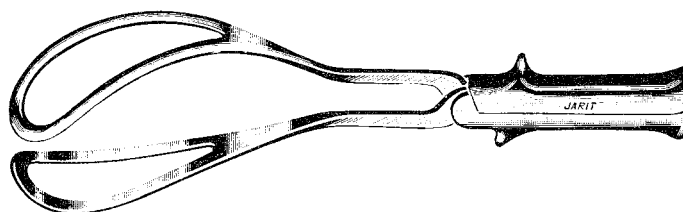

**Simpson Obstetrical Forceps**

Catalog #	Description
510-220	12¼" (313mm)

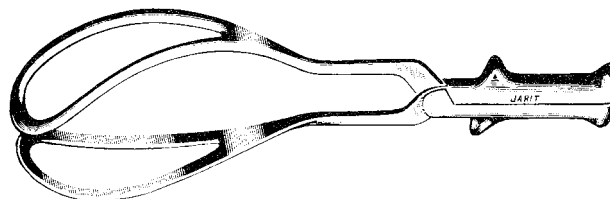

### Simpson Obstetrical Forceps

Catalog #	Description
510-225	14¼" (365mm)

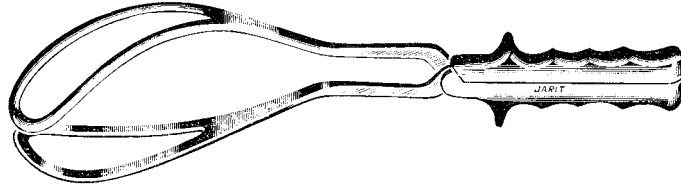

### McLane-Tucker Obstetrical Forceps

Catalog #	Description
510-235	15¼" (390mm)

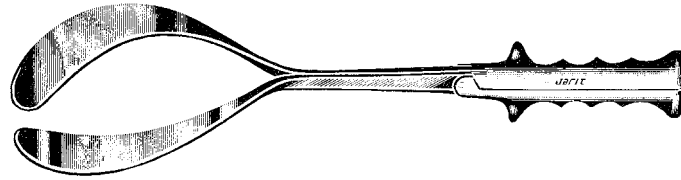

### Elliott Obstetrical Forceps

Catalog #	Description
510-245	15½" (395mm)

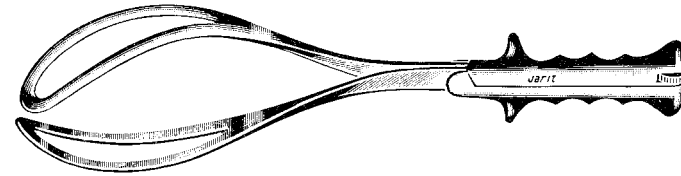

### Kieland Obstetrical Forceps

Catalog #	Description
510-260	16" (405mm)

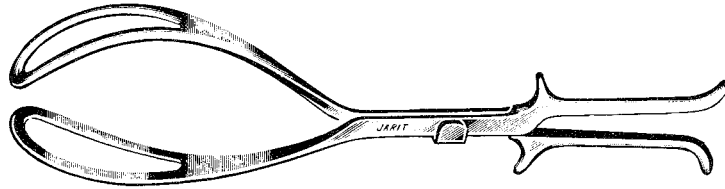

### Luikhart Obstetrical Forceps

Catalog #	Description
510-265	16" (405mm)

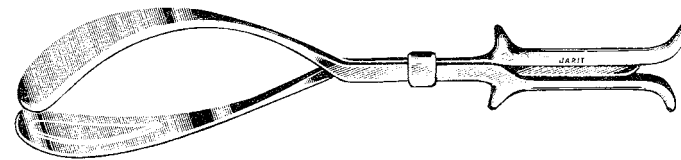

**McLane-Tucker-Luikhart Obstetrical Forceps**

Catalog #	Description
510-275	15¾" (400mm)

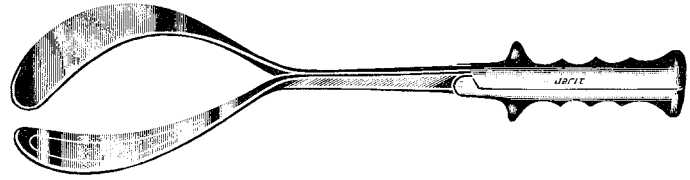

**Simpson-Luikhart Obstetrical Forceps**

Catalog #	Description
510-290	14¼" (360mm)

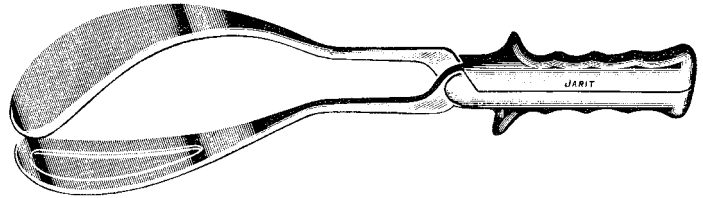

**Piper Obstetrical Forceps**

Catalog #	Description
510-300	18¼" (465mm)

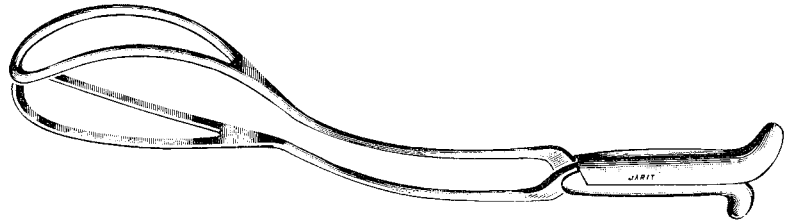

**Bill Traction Handle**

Catalog #	Description
510-330	For use with all O.B. Forceps having standad type handle

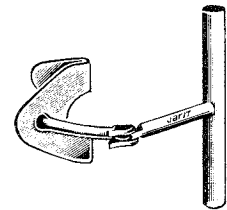

# Integra™ Bariatric Instruments and General Surgical Instruments

Integra Jarit offers a comprehensive line of high quality surgical instruments for Bariatric Surgery. As the demand continues to grow for surgical instruments for both open and laparoscopic surgical approaches, Jarit includes instruments to support the techniques involved in these challenging surgical procedures.

For open surgery, 12" and 14" long instruments: full line of forceps, clamps, scissors, needle holders, and retractors.

**Mayo Scissors, Carb-Edge**

14 1/4" (361mm)

Catalog #	Description
101-230	Straight
101-232	Curved

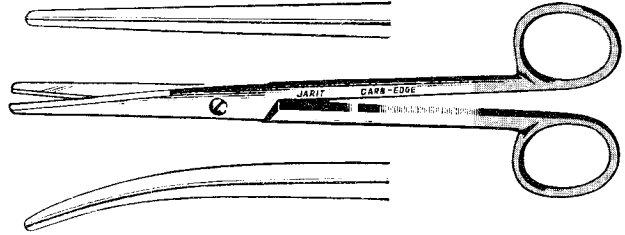

**Metzenbaum Scissors, Carb-Edge**

Catalog #	Description
101-272	12 1/4" (310mm), curved
101-256	14 1/4" (364mm), curved

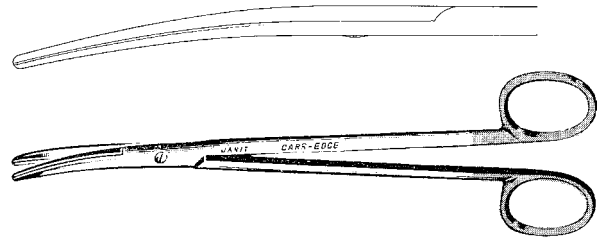

**Metzenbaum Scissors, Supercut**

Catalog #	Description
102-129	12" (302mm), curved
102-127	14" (356mm), curved

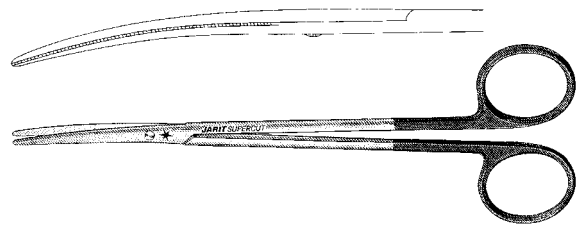

**Pean Forceps**

horizontal serrations

Catalog #	Description
135-262	11" (280mm), straight, jaw length 3 1/2" (89mm)
135-265	11" (280mm), curved, jaw length 3 1/2" (89mm)
135-263	12" (305mm), straight, jaw length 3 1/2" (89mm)
135-266	12" (305mm), curved, jaw length 3 1/2" (89mm)
135-264	14" (356mm), straight, jaw length 3 1/2" (89mm)
135-267	14" (356mm), curved, jaw length 3 1/2" (89mm)

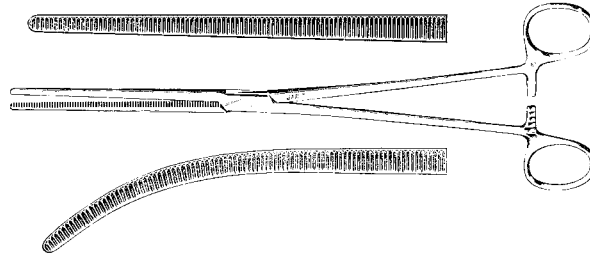

**Rochester-Ochsner Forceps**

Catalog #	Description
105-229	12" (305mm), straight
105-228	14" (356mm), straight

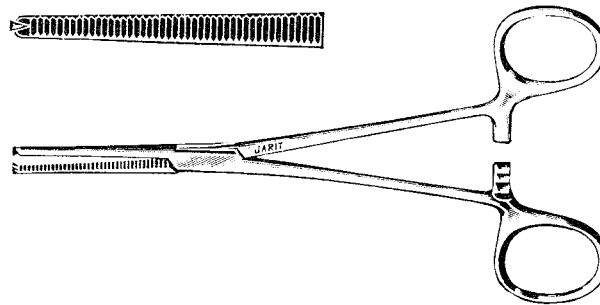

**Foerster Sponge Forceps, (Matte Finish)**

Manufactured from high grade German surgical stainless steel which is glass beaded to a matte finish

Catalog #	Description
114-124	14" (357mm), straight, serrated

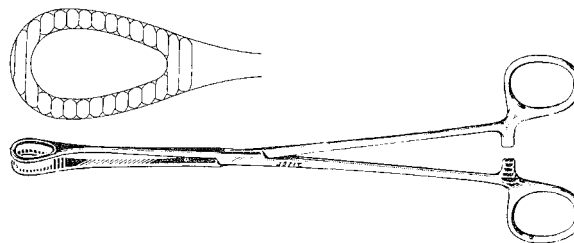

**Dressing Forceps**

serrated

Catalog #	Description
130-130	11 3/4" (300mm)
130-132	14" (355mm)



### Tissue Forceps

1 x 2 teeth

Catalog #	Description
130-180	12" (303mm)
130-182	14" (355mm)



### Russian Tissue Forceps

Catalog #	Description
130-194	12" (305mm)
130-196	14" (355mm)



### Singly Tissue Forceps

Catalog #	Description
135-248	14" (356mm)



### Babcock Tissue Forceps

Catalog #	Description
135-196	11¾" (300mm), jaw width 11.3mm
135-194	13¾" (350mm), jaw width 12mm

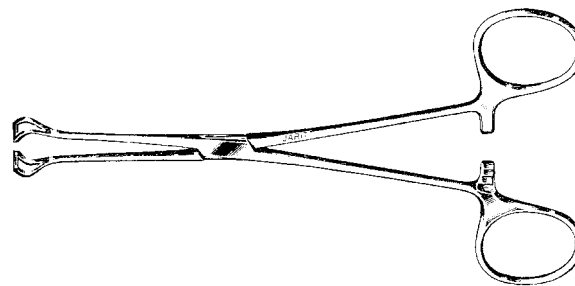

### Gemini Artery Clamp

Catalog #	Description
140-335	14¼" (360mm)

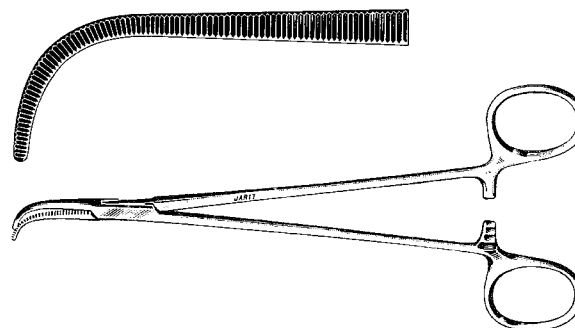



**Allis-Willauer Tissue Forceps**

5 x 6 teeth

Catalog #	Description
305-231	11" (282mm), 5.7mm jaw width
305-233	13¾" (350mm), 5.7mm jaw width

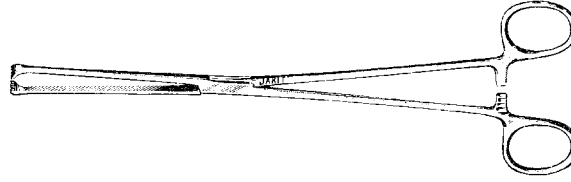

**Sarot Artery Forceps**

13¾" (350mm)

Catalog #	Description
305-366	3" (75mm) jaw length

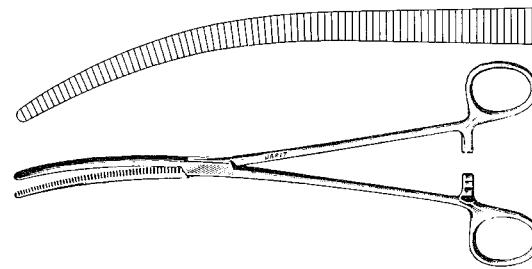

**DeBakey-Collier Artery Forceps**

14" (356mm)

Catalog #	Description
305-369	1¾" (44mm) jaw length

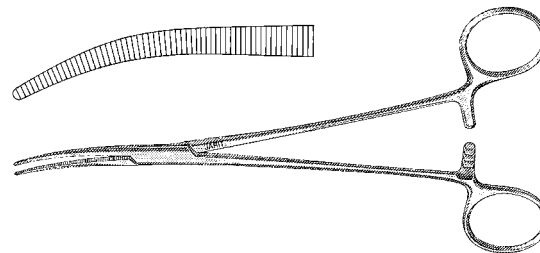

**DeBakey Vascular Tissue Forceps, Cardio-Grip™**

Straight, 2mm tips

Catalog #	Description
320-109	12" (300mm)
320-108	14" (360mm)

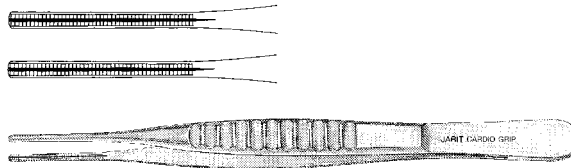

**Harrington (Mixer) Forceps**

right angled, light

Catalog #	Description
305-395	12 1/4" (311mm)
305-396	14 1/4" (360mm)

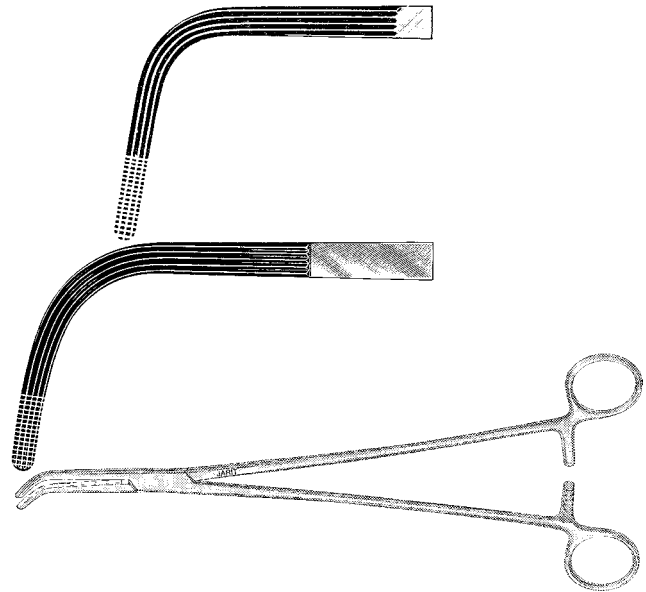

**Rochester-Pean Forceps**

12" (305mm)

Catalog #	Description
105-199	straight, 3 1/2" (90mm) jaw length

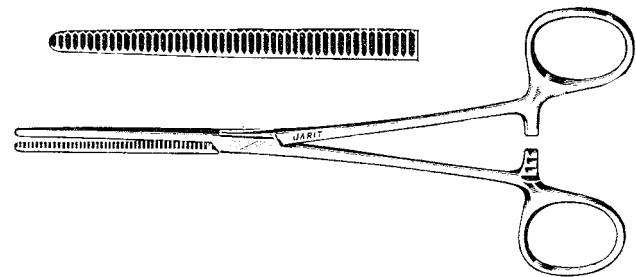

**Rochester-Pean Forceps**

curved, Longitudinal serrations

Catalog #	Description
305-398	11 3/4" (300mm), 3 7/8" (99mm) jaw length
305-399	14" (354mm), 4 3/8" (111mm) jaw length

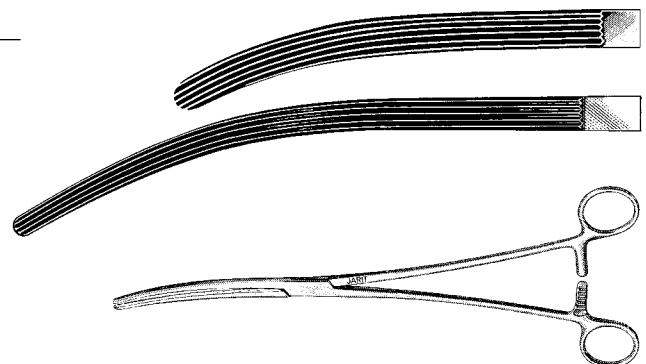

**Crile-Wood Needle Holder, Carb-Bite**

4000 teeth per square inch, for use with 4.0 and 5.0 suture

Catalog #	Description
121-129	12 1/4" (311mm), 18.5mm jaw length
121-128	14" (356mm), 19mm jaw length

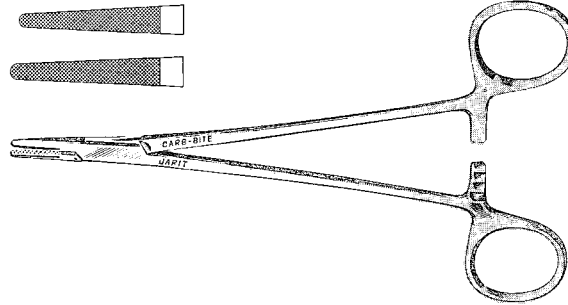

**Mayo-Hegar Needle Holder, Carb-Bite**

2500 teeth per square inch, for use with 2.0 and 3.0 suture

Catalog #	Description
121-147	11 3/4" (300mm), 19mm jaw length
121-144	13 3/4" (350mm), 19mm jaw length

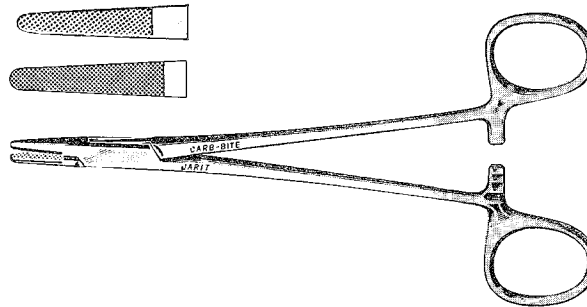

**Heaney Needle Holder, Carb-Bite**

2500 teeth per square inch, for use with 2.0 and 3.0 suture

Catalog #	Description
121-204	11 3/4" (300mm), 20mm jaw length

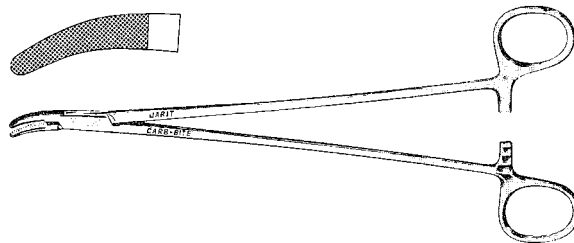

**Poole Suction Tubes**

straight, 32 French

Catalog #	Description
170-103	12" (305mm)
170-104	15" (378mm)
170-ITB-103	Replacement Inner Tube



**Yankaur Suction Tube**

Catalog #	Description
170-117	15" (378mm)

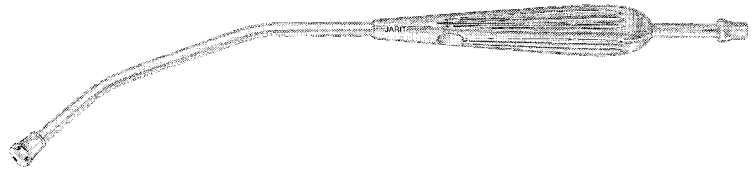

**Cushing Vein Retractor**

blade 3/8" x 3/8" (95mm x 95mm)

Catalog #	Description
200-136	11" (279mm)
200-137	14" (356mm)



**Deaver Retractor**

Catalog #	Description
200-204	1" x 14" (25mm x 356mm)

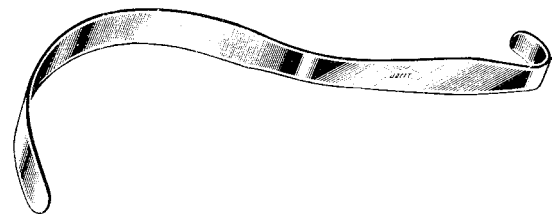

**Deaver Retractor**

Hollow Grip Handle

Catalog #	Description
201-203	2 1/2" x 14 1/2" (63mm x 368mm)

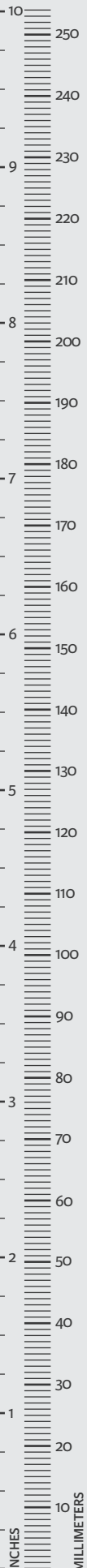
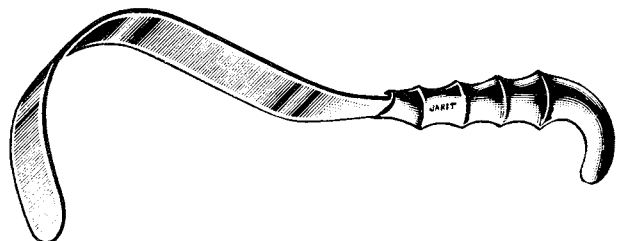

# **Integra**<sup>™</sup> Containers, Trays and Accessories

Integra Sterilization Containers feature a broad range of sizes to support your instrument storage requirements.

**One-Half Size Container with Lid**

11 1/4" x 11" (286mm x 280mm)

**Solid Bottom Container with Lid**

Catalog #	Description
730-100	4" (102mm)
730-101	5 1/3" (136mm)
730-102	6" (152mm)
730-103	8" (203mm)



**Perforated Bottom Container with Lid**

Catalog #	Description
730-110	4" (102mm)
730-111	5 1/3" (136mm)
730-112	6" (152mm)
730-113	8" (203mm)

**Color Lids Available,  
Lids and Bottoms Must Be Ordered Separately**

**Color Lids Only for Half-Size Containers**

Catalog #	Description
730-120	Silver
730-121	Blue
730-122	Red
730-123	Gold
730-124	Green
730-125	Black



### Solid Bottom only Container without Lid

Catalog #	Description
730-100B	4" (102mm)
730-101B	5 1/3" (136mm)
730-102B	6" (152mm)
730-103B	8" (203mm)



### Perforated Bottom only Container without Lid

Catalog #	Description
730-110B	4" (102mm)
730-111B	5 1/3" (136mm)
730-112B	6" (152mm)
730-113B	8" (203mm)

### One-Half Size Wire/Perforated Baskets

10" x 9 1/2" (252mm x 242mm)

#### Wire Baskets

Catalog #	Description
740-100	2 3/8" (59mm)
740-101	3 1/8" (78mm)
740-102	4 1/4" (108mm)



#### Perforated Baskets

Catalog #	Description
750-100	2 3/8" (59mm)
750-101	3 1/8" (78mm)
750-102	4 1/4" (108mm)

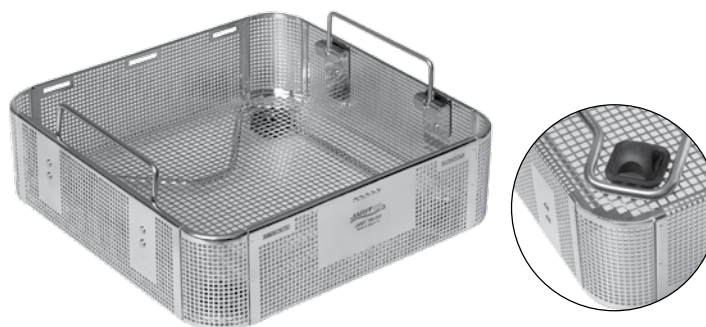

### One-Half Size Container Lid Only—Silver

Catalog #	Description
730-120	One-half size



### Three-Quarter Size Container with Lid

18 1/4" x 11" (465mm x 280mm)

#### Solid Bottom Container with Lid

Catalog #	Description
730-200	4" (102mm)
730-201	5 1/3" (136mm)
730-202	6" (152mm)



#### Perforated Bottom Container with Lid

Catalog #	Description
730-210	4" (102mm)
730-211	5 1/3" (136mm)
730-212	6" (152mm)

**Color Lids Available,  
Lids and Bottoms Must Be Ordered Separately**

#### Color Lids Only for Three-Quarter Size Containers

Catalog #	Description
730-220	Silver
730-221	Blue
730-222	Red
730-223	Gold
730-224	Green
730-225	Black





### Solid Bottom only Container without Lid

Catalog #	Description
730-200B	4" (102mm)
730-201B	5 1/3" (136mm)
730-202B	6" (152mm)



### Perforated Bottom only Container without Lid

Catalog #	Description
730-210B	4" (102mm)
730-211B	5 1/3" (136mm)
730-212B	6" (152mm)

### Three-Quarter Size Wire/Perforated Baskets

15 3/4" x 10" (402mm x 252mm)

#### Wire Baskets

Catalog #	Description
740-200	2 3/8" (59mm)
740-201	3 1/8" (78mm)
740-202	4 1/4" (108mm)



#### Perforated Baskets

Catalog #	Description
750-200	2 3/8" (59mm)
750-201	3 1/8" (78mm)
750-202	4 1/4" (108mm)

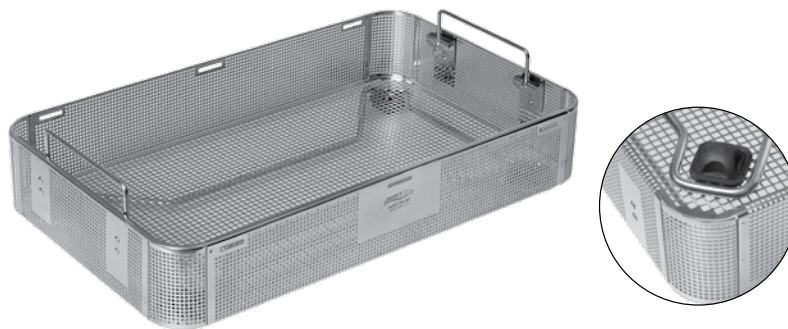

### Three-Quarter Size Container Lid Only

Catalog #	Description
730-220	Three-quarter size



### Full-Size Container with Lid—Silver

23" x 11" (585mm x 280mm)

#### Solid Bottom Container with Lid

Catalog #	Description
730-300	4" (102mm)
730-301	5 1/3" (136mm)
730-302	6" (152mm)
730-303	8" (203mm)



#### Perforated Bottom Container with Lid

Catalog #	Description
730-310	4" (102mm)
730-311	5 1/3" (136mm)
730-312	6" (152mm)
730-313	8" (203mm)

**Color Lids Available,  
Lids and Bottoms Must Be Ordered Separately**

#### Color Lids Only for Three-Quarter Size Containers

Catalog #	Description
730-320	Silver
730-321	Blue
730-322	Red
730-323	Gold
730-324	Green
730-325	Black



### Solid Bottom only Container without Lid

Catalog #	Description
730-300B	4" (102mm)
730-301B	5 1/3" (136mm)
730-302B	6" (152mm)
730-303B	8" (203mm)



### Perforated Bottom only Container without Lid

Catalog #	Description
730-310B	4" (102mm)
730-311B	5 1/3" (136mm)
730-312B	6" (152mm)
730-313B	8" (203mm)

### Full-Size Wire/Perforated Baskets

21 1/4" x 10" (538mm x 252mm)

#### Wire Baskets

Catalog #	Description
740-300	2 3/8" (59mm)
740-301	3 1/8" (78mm)
740-302	4 1/4" (108mm)



#### Perforated Baskets

Catalog #	Description
750-300	2" (50mm)
750-301	3" (76mm)
750-302	4" (102mm)



**Full-Size Container Lid Only–Silver**

Catalog #	Description
730-320	Full-size



**Instrument Holding Rack**

Catalog #	Description
790-010	Instrument rack

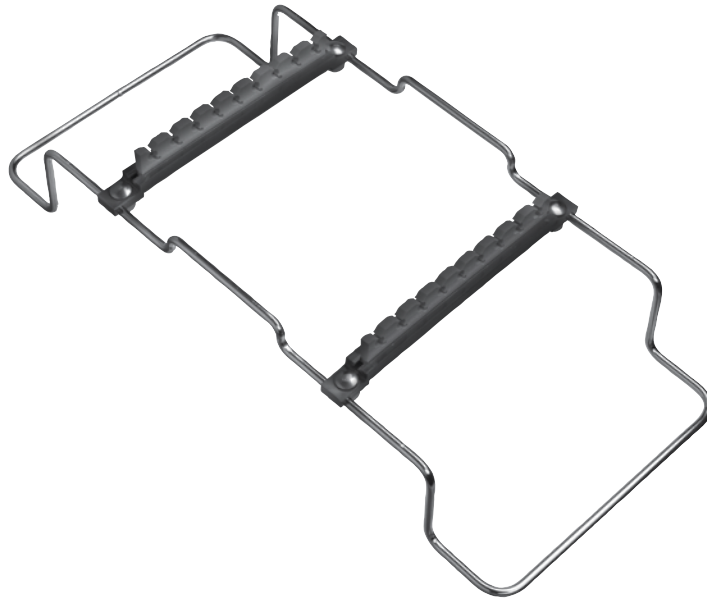

### Sterilization Filters

Catalog #	Description
775-200	Single use, round 7½", box of 1,000



### Sterile Indicator Cards

Catalog #	Description
775-300	Indicates for use in gas or steam, box of 250

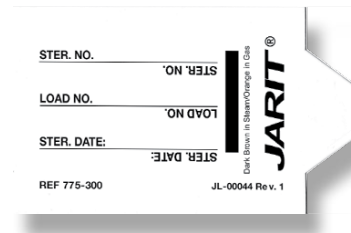

### Tamper Evident Locks

Catalog #	Description
775-400	Blue, box of 1,000

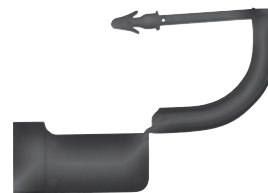

### Container Lids Only

Catalog #	Description
730-120	One-half size
730-220	Three-quarter size
730-320	Full-size



### Identification Tags

Catalog #	Description
775-100	ID Tag, silver
775-101	ID Tag, blue
775-102	ID Tag, red
775-103	ID Tag, gold
775-104	ID Tag, green
775-105	ID Tag, black

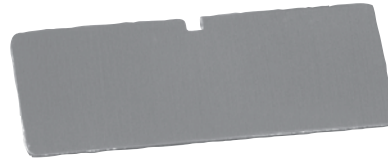

Contents/Delivery Address—custom laser etching available with order.  
Each tag allows up to 14 characters.

### Small Snap-On Basket Tags (with Key Ring)

Two Sizes Available, 2<sup>3</sup>/<sub>8</sub>" x 1/2" or 2<sup>3</sup>/<sub>8</sub>" x 1<sup>1</sup>/<sub>8</sub>"

Catalog #	Description
775-120	Silver
775-121	Blue
775-122	Red
775-123	Gold
775-124	Green
775-125	Black



### Large Snap-On Basket Tags (with Key Ring)

2<sup>3</sup>/<sub>8</sub>" x 1<sup>1</sup>/<sub>4</sub>"

Catalog #	Description
775-130	Silver
775-131	Blue
775-132	Red
775-133	Gold
775-134	Green
775-135	Black

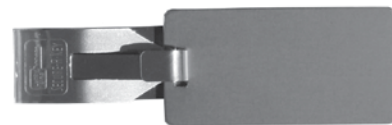

**Instrument Trays**

Catalog #	Description
117-100	5" x 15½" x 3" (127mm x 394mm x 76mm)
117-102	6" x 24" x 3½" (152mm x 610mm x 89mm)
117-106	8" x 25¼" x 3½" (203mm x 642mm x 89mm)
117-108	10" x 6½" x 2½" (254mm x 165mm x 64mm)
117-110	10½" x 10" x 3½" (267mm x 254mm x 89mm)
117-112	10½" x 15" x 3½" (267mm x 394mm x 89mm)
117-114	10½" x 20" x 3½" (267mm x 508mm x 89mm)
117-116	13" x 20¼" x 3½" (330mm x 514mm x 89mm)
117-118	13" x 20¼" x 3½" (330mm x 514mm x 89mm)



**Lifting Handles**

Catalog #	Description
117-120	For lifting and carrying instrument trays, set of 2

(Not Pictured)

**Covered Instrument Trays**

with positive locking latch,  
removable cover can be stored under tray during use

Catalog #	Description
117-130	5" x 15½" x 3" (127mm x 394mm x 76mm)
117-132	6" x 24" x 3½" (152mm x 610mm x 89mm)
117-136	8" x 25¼" x 3½" (203mm x 641mm x 89mm)
117-138	10" x 6½" x 2½" (254mm x 165mm x 64mm)
117-140	10½" x 10" x 3½" (267mm x 254mm x 89mm)
117-142	10½" x 15" x 3½" (267mm x 394mm x 89mm)
117-144	10½" x 20" x 3½" (267mm x 508mm x 89mm)
117-148	13" x 20¼" x 3½" (330mm x 514mm x 89mm)



**Mayo Trays, Perforated**

Catalog #	Description
117-160	10" x 6½" x ¾" (254mm x 165mm x 19mm)
117-162	13½" x 9¾" x ¾" (343mm x 248mm x 19mm)
117-164	15" x 10⅝" x ¾" (384mm x 270mm x 19mm)
117-166	17" x 11⅝" x ¾" (432mm x 295mm x 19mm)
117-168	19" x 12⅝" x ¾" (486mm x 321mm x 19mm)
117-170	21¼" x 16¼" x ¾" (540mm x 413mm x 22mm)



### Flash Autoclaving Pans, Tray and Safety Handle

Catalog #	Description
117-180	Pan, 9" x 5" x 2" (225mm x 127mm x 50mm)
117-182	Pan, 10" x 6½" x 2½" (254mm x 165mm x 50mm)
117-184	Tray, 10" x 6½" x 2½" (254mm x 165mm x 63mm)
117-188	Safety handle

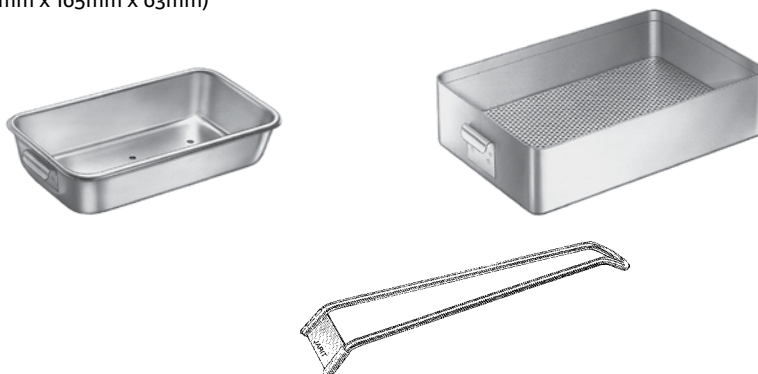

### Deep Perforated Instrument Pans

Catalog #	Description
117-190	9" x 5" x 2" (229mm x 129mm x 51mm)
117-192	10" x 6½" x 2" (255mm x 165mm x 51mm)
117-194	12½" x 7¾" x 2½" (310mm x 199mm x 56mm)
117-196	12¾" x 10½" x 2½" (321mm x 262mm x 64mm)
117-198	16" x 10" x 2½" (420mm x 255mm x 64mm)
117-199	20¾" x 12¾" x 2½" (531mm x 326mm x 64mm)



### Weinstein Instrument Holders

2¾" (71mm) wide

Catalog #	Description
117-240	6" (152mm)
117-242	8" (203mm)
117-244	10" (254mm)
117-246	12" (305mm)
117-247	14" (356mm)
117-248	16" (406mm)
117-249	18" (457mm)

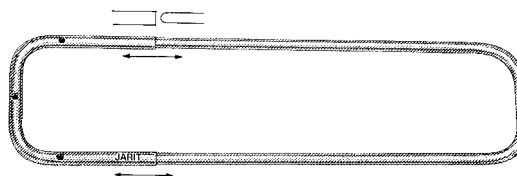



## Posilock Instrument Holders

2¾" (71mm) wide

Catalog #	Description
117-250	6" (152mm)
117-252	8" (203mm)
117-254	10" (254mm)
117-256	12" (305mm)
117-258	14" (356mm)
117-260	16" (406mm)
117-262	18" (457mm)

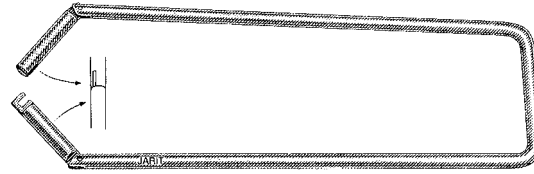

## Instrument Stringers

2¾" (71mm) wide

Catalog #	Description
117-270	8" (203mm)
117-272	10" (254mm)
117-274	12" (305mm)
117-276	14" (356mm)
117-278	16" (406mm)
117-280	18" (457mm)



## Instrument Holding Racks

Catalog #	Description
117-330	with four vertical pins, keeps box locks open during sterilization
117-340	Tray Pins, box of 10

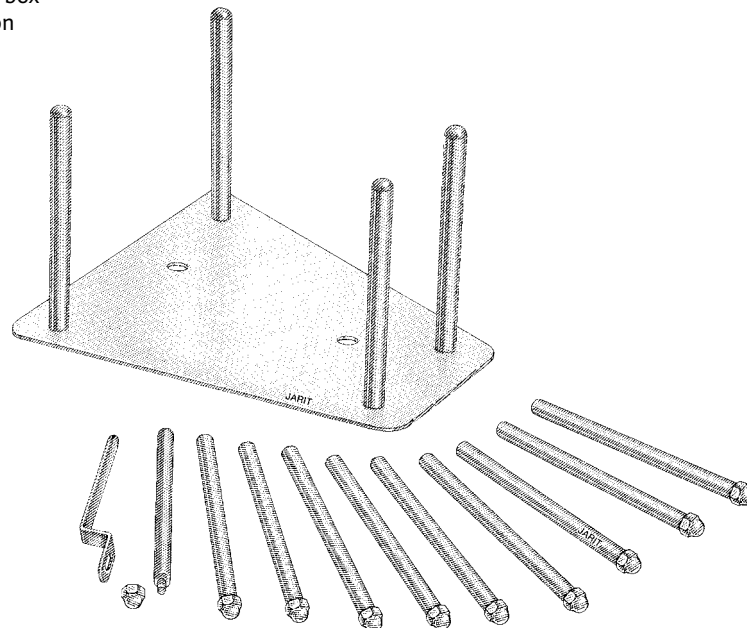

**Bunt Forceps Holder**

Catalog #	Description
118-116	4 1/4" (108mm)

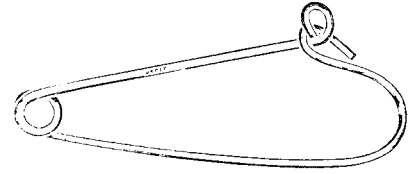

**Weisenbach Forcep Holder**

Catalog #	Description
118-118	6 1/4" (158mm)
118-119	12 1/4" (310mm)

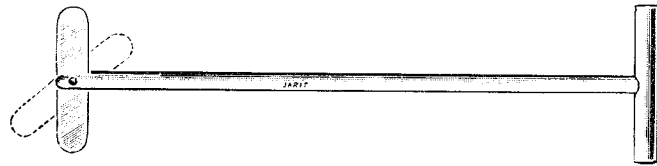

## Graduated Measure

Catalog #	Description
117-370	4 <sup>3</sup> / <sub>4</sub> " x 5 <sup>1</sup> / <sub>4</sub> " (121mm x 133mm), 32 oz (1000cc)



## Solutions Basin

Catalog #	Description
117-380	13 <sup>5</sup> / <sub>8</sub> " x 4 <sup>5</sup> / <sub>8</sub> " (346mm x 117mm), 7 qt
117-381	14 <sup>1</sup> / <sub>2</sub> " x 5" (368mm x 127mm), 9 <sup>1</sup> / <sub>2</sub> qt



## Iodine Cup

Catalog #	Description
117-360	3 <sup>3</sup> / <sub>8</sub> " x 2" (86mm x 51mm), 6 oz



## Medicine Cup

Catalog #	Description
117-365	2 <sup>1</sup> / <sub>8</sub> " x 2" (54mm x 51mm), 2 oz, graduated



## Emesis Basin

Catalog #	Description
117-390	6 <sup>5</sup> / <sub>8</sub> " x 3 <sup>1</sup> / <sub>2</sub> " x 1 <sup>1</sup> / <sub>2</sub> " (168mm x 89mm x 38mm)
117-391	8 <sup>1</sup> / <sub>8</sub> " x 3 <sup>5</sup> / <sub>8</sub> " x 1 <sup>5</sup> / <sub>8</sub> " (206mm x 92mm x 41mm)
117-392	9 <sup>7</sup> / <sub>8</sub> " x 4 <sup>1</sup> / <sub>2</sub> " x 2 <sup>1</sup> / <sub>8</sub> " (251mm x 114mm x 54mm)



### Lambotte Rack

Catalog #	Description
250-090	Stainless steel, holds 12 Jarit Lambotte 9" osteotomes, rack size: 3" x 7 <sup>3</sup> / <sub>8</sub> " x 11 <sup>1</sup> / <sub>8</sub> " (76mm x 187mm x 283mm)

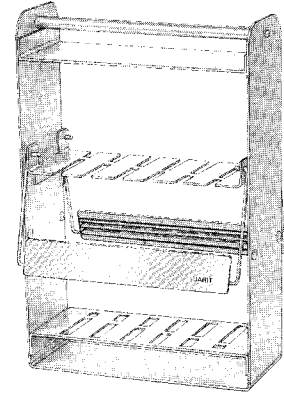

### Hibbs-Bruns Curette Rack

Catalog #	Description
250-092	Stainless steel, holds 12 Jarit 6 <sup>3</sup> / <sub>4</sub> ", 8" and 9" Bruns, curettes, rack size: 2 <sup>1</sup> / <sub>2</sub> " x 7 <sup>3</sup> / <sub>8</sub> " x 11 <sup>1</sup> / <sub>8</sub> " (64mm x 187mm x 283mm)

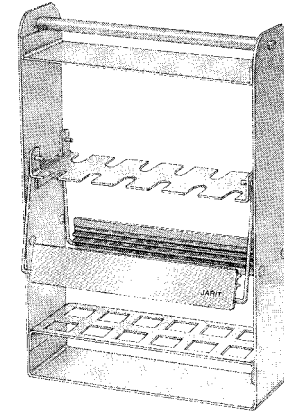

### Hibbs-Bruns Curette Rack

Catalog #	Description
250-084	Stainless steel, holds 12 Jarit Bruns 6 <sup>3</sup> / <sub>4</sub> ", 8" and 9" Bruns, curettes, rack size: 2 <sup>1</sup> / <sub>2</sub> " x 9" x 12 <sup>1</sup> / <sub>2</sub> " (64mm x 231mm x 305mm)



### Bruns Curette Rack

Catalog #	Description
250-093	Stainless steel, holds 12 Jarit Bruns 6 <sup>3</sup> / <sub>4</sub> " curettes, rack size: 2 <sup>1</sup> / <sub>2</sub> " x 7 <sup>3</sup> / <sub>8</sub> " x 9 <sup>1</sup> / <sub>4</sub> " (64mm x 187mm x 235mm)

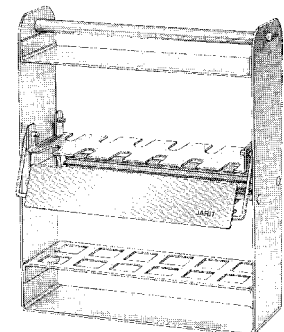

### Smith-Petersen Osteotome Rack

Catalog #	Description
250-095	Stainless steel, holds 7 Jarit Smith-Petersen 8" gouges, osteotomes, rack size: 2" x 10 <sup>5</sup> / <sub>8</sub> " x 9 <sup>7</sup> / <sub>8</sub> " (51mm x 270mm x 251mm)

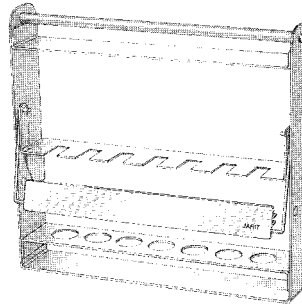

### Cobb Type Instrument Rack

Catalog #	Description
250-097	Stainless steel, holds 9 Jarit Cobb-Type 11" instruments, rack size: 1 <sup>3</sup> / <sub>4</sub> " x 14" x 13 <sup>1</sup> / <sub>4</sub> " (44mm x 356mm x 337mm)

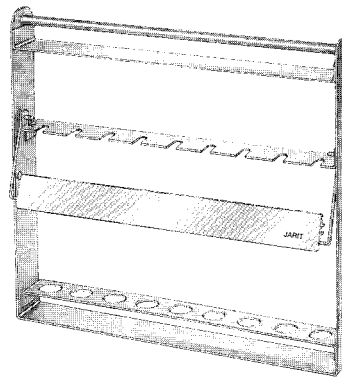

### Hoke Osteotome Rack

Catalog #	Description
250-099	Stainless steel, holds 6 Jarit Hoke 5" osteotomes, rack size: 1 <sup>1</sup> / <sub>2</sub> " x 5 <sup>3</sup> / <sub>4</sub> " x 7" (38mm x 146mm x 178mm)

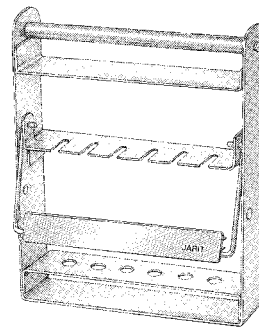

### Lambotte Mini Osteotome Rack (Metal)

Catalog #	Description
250-380	Holds up to 9 assorted mini osteotomes 2mm x 20mm, 5 <sup>1</sup> / <sub>2</sub> " x 6 <sup>1</sup> / <sub>2</sub> " x 1 <sup>1</sup> / <sub>2</sub> " (140mm x 165mm x 13mm)



### Rhoton-Type Instrument Rack

10" x 8" (253mm x 201mm)

Catalog #	Description
277-275	For storing 15 stainless steel or titanium instruments

Catalog #	Description
277-275TI	10" x 8 3/4" x 1" (253mm x 223mm x 25mm), for storing 19 stainless steel or titanium instruments

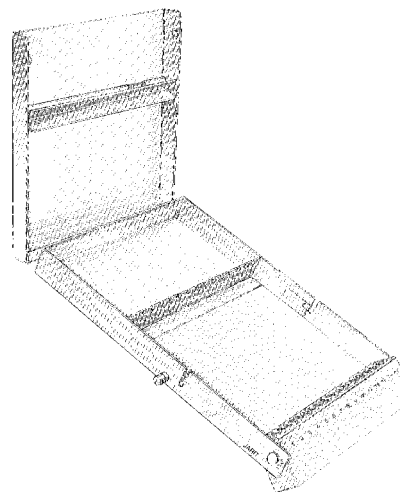

### Instrument Rack (Craig Biopsy)

Catalog #	Description
280-559	1 Instrument Rack

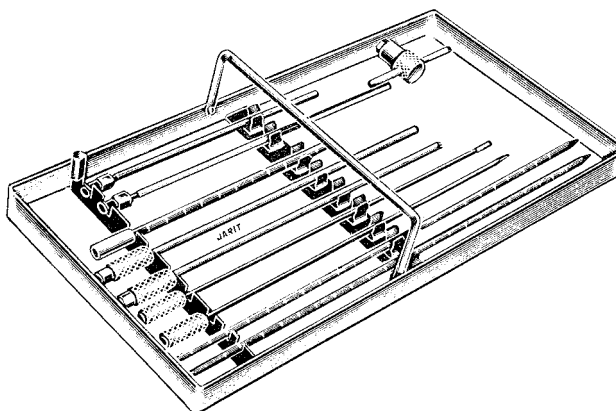

### Instrument Holding Rack

9 slot, 5-10mm diameter silicone bars

Catalog #	Description
790-010	Fits into a full size 8" container and a 2" or 3" basket, 10" x 19 3/4" x 4 3/8" (220mm x 500mm x 110mm)

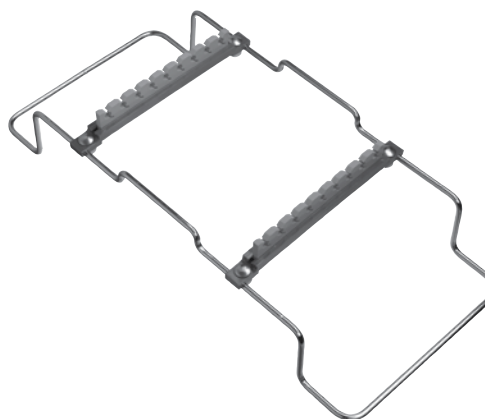

### Nabatoff Vein Stripper (Case Only)

Catalog #	Description
160-CAS-120	Stainless Steel Case for Nabatoff Stripper

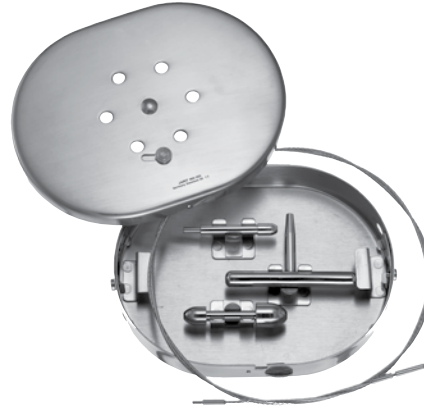

### Diethrich Coronary Artery Bypass Case Only

Catalog #	Description
310-381	1ea Instrument Case

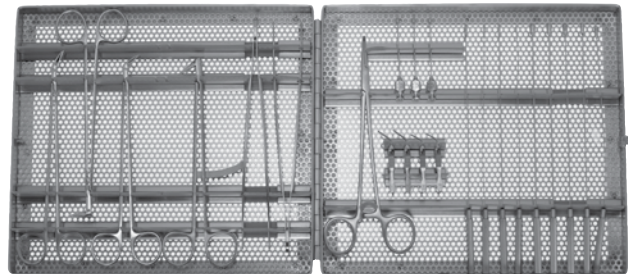

### Garrett Dilator Case

Catalog #	Description
310-405	9" x 5 1/8" x 3/4" (230mm x 130mm x 20mm)

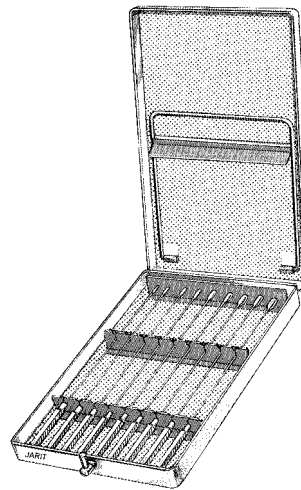

**DeBakey Dilator Case**

Catalog #	Description
310-465	9 1/4" x 5 3/4" x 1/2" (232mm x 146mm x 13mm)



**Eye and Plastic Surgery Cases**

for eye, plastic surgery, and microsurgical instruments, scissors, knives, and forceps, etc., are held securely on bed of silicone rubber, cover is removable.

Catalog #	Description
360-502	10 1/2" x 10" (267mm x 254mm)
360-504	10 1/2" x 15" (267mm x 381mm)

**Eye and Plastic Surgery Cases**

same as shown above, but stainless steel mesh is coated with autoclavable plastic for better protection of microsurgical instruments

Catalog #	Description
360-512	10 1/2" x 10" (267mm x 254mm)
360-514	10 1/2" x 15" (267mm x 381mm)

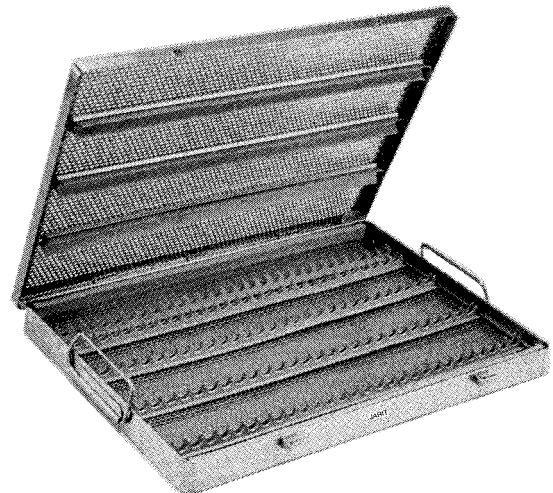



### Laparoscopic Instrument Case

Catalog #	Description
600-618	22¾" x 11" x 8" (579mm x 282mm x 203mm)

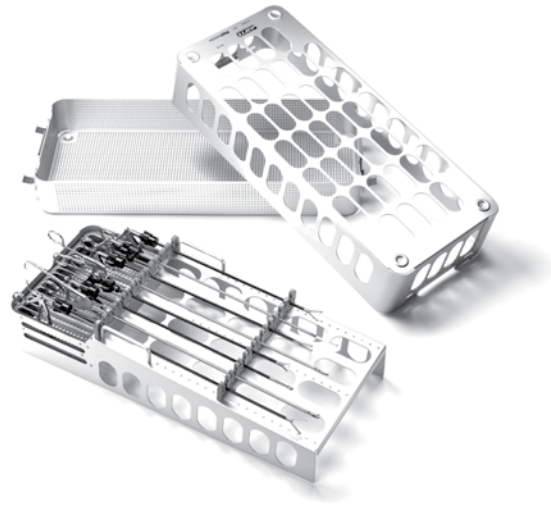

### Bariatric Instrument Case

Catalog #	Description
600-620	26¾" x 11" x 8" (681mm x 282mm x 203mm)

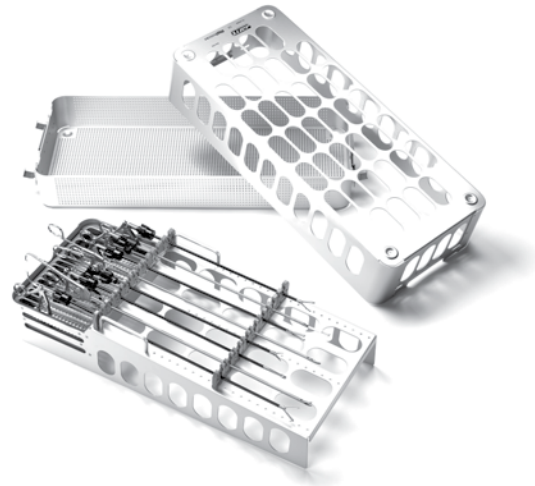

### Garrett Dilator Holders

Catalog #	Description
310-406	7¾" (200mm)
310-407	5½" (140mm)



### Tray for Sinuscope

Catalog #	Description
440-510	6" x 15 <sup>1</sup> / <sub>4</sub> " x 3 <sup>1</sup> / <sub>2</sub> " (152mm x 390mm x 90mm), holds two sinuscope

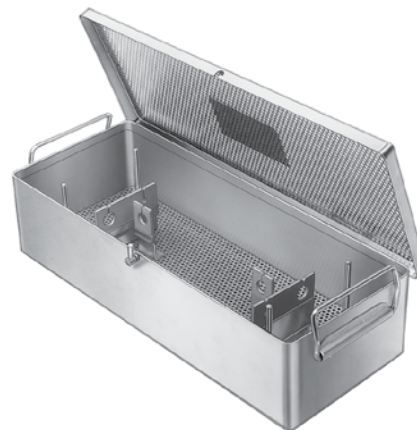

### Instrument Tip-It™ Protectors

Catalog #	Description
760-400	Tip-It Protectors size 1 white vent, 1/16" x 3/4" (1.6mm x 19mm), 50/pkg
760-405	Tip-It Protectors size 2 blue vent, 5/64" x 3/4" (2mm x 19mm), 50/pkg
760-410	Tip-It Protectors size 3 green vent, 7/64" x 3/4" (2.8mm x 19mm), 50/pkg
760-415	Tip-It Protectors size 4 red vent, 1/8" x 1" (3.2mm x 25.4mm), 50/pkg
760-420	Tip-It Protectors size 5 yellow vent, 3/16" x 1" (4.8mm x 25.4mm) 50/pkg
760-425	Tip-It Protectors size 6 maroon vent, 13/32" x 3/4" (10.3mm x 19mm) 50/pkg
760-430	Tip-It Protectors size 7 orange vent, 1/16" x 3/8" x 1" (1.6mm x 9.5mm x 25.4mm) 50/pkg
760-435	Tip-It Protectors size 8 brown vent, 5/64" x 5/8" x 1" (2mm x 16mm x 25.4mm) 50/pkg
760-440	Tip-It Protectors size 9 black vent, 1/8" x 1" x 1" (3.2mm x 25.4mm x 25.4mm) 50/pkg
760-445	Tip-It Protectors assorted vent, 9ea color plus 5 extra, 50/pkg

### Instrument Tip-It™ Protectors

Catalog #	Description
760-450	Tip-It Protectors size 1 white, 1/16" x 3/4" (1.6mm x 19mm), 50/pkg
760-455	Tip-It Protectors size 2 blue, 5/64" x 3/4" (2mm x 19mm), 50/pkg
760-460	Tip-It Protectors size 3 green, 7/64" x 3/4" (2.8mm x 19mm), 50/pkg
760-465	Tip-It Protectors size 4 red, 1/8" x 1" (3.2mm x 25.4mm), 50/pkg
760-470	Tip-It Protectors size 5 yellow 3/16" x 1" (4.8mm x 25.4mm) 50/pkg
760-475	Tip-It Protectors size 6 maroon, 13/32" x 3/4" (10.3mm x 19mm) 50/pkg
760-480	Tip-It Protectors size 7 orange, 1/16" x 3/8" x 1" (1.6mm x 9.5mm x 25.4mm) 50/pkg
760-485	Tip-It Protectors size 8 brown, 5/64" x 5/8" x 1" (2mm x 16mm x 25.4mm) 50/pkg
760-490	Tip-It Protectors size 9 black, 1/8" x 1" x 1" (3.2mm x 25.4mm x 25.4mm) 50/pkg
760-495	Tip-It Protectors assorted vent, 9ea color plus 5 extra, 50/pkg



# **Integra™** Suture Guide & Conversion Tables



Product	Suture Size		0	2-0	3-0	4-0	5-0	6-0	7-0	8-0	9-0	10-0
	Insert	Teeth Per Square Inch Tip Width										
121-097	TC	4000				•	•					
121-100	TC	4000				•	•	•				
121-105	TC	4000		•	•	•						
121-106	TC	2500		•	•	•						
121-115	TC	7000						•	•	•		
121-116	TC	Smooth						•	•	•		
121-118	TC	Smooth					•	•				
121-119	TC	3600					•	•				
121-120	TC	Smooth				•	•					
121-121	TC	4000				•	•					
121-125	TC	4000		•	•	•						
121-126	TC	4000				•	•	•				
121-127	TC	4000				•	•	•				
121-128	TC	4000				•	•					
121-129	TC	4000				•	•					
121-130	TC	4000				•	•	•				
121-131	TC	4000				•	•	•				
121-132	TC	4000				•	•	•				
121-133	TC	4000				•	•	•				
121-134	TC	4000				•	•	•				
121-135	TC	2500		•	•	•						
121-140	TC	2500		•	•	•						
121-142	TC	2500		•	•	•						
121-143	TC	2500		•	•	•						
121-144	TC	2500		•	•	•						
121-145	TC	2500		•	•	•						
121-146	TC	2500		•	•	•						
121-147	TC	2500		•	•	•						
121-148	TC	7000						•	•			
121-149	TC	Smooth						•	•			
121-150	TC	4000				•	•	•				
121-155	TC	4000				•	•	•				
121-160	TC	4000	1.65mm			•	•	•				
121-161	TC	4000	1.65mm			•	•	•				
121-161TI	TC											
121-162	TC	4000	1.65mm			•	•	•				
121-162TI	TC											
121-163	TC	4000	1.65mm			•	•	•				
121-163TI	TC											
121-164	TC	4000	1.65mm			•	•	•				
121-165	TC	4000	1.65mm			•	•	•				
121-166	TC	4000	1.65mm			•	•	•				
121-170	TC	7000	1mm				•	•	•			
121-171	TC	Smooth	1mm				•	•	•			
121-172	TC	7000	1mm				•	•	•			
121-173	TC	Smooth	1mm				•	•	•			

Product	Suture Size		Teeth Per Square Inch	Tip Width	0	2-0	3-0	4-0	5-0	6-0	7-0	8-0	9-0	10-0
	Insert													
121-174	TC	7000		1mm					•	•	•			
121-175	TC	Smooth		1mm					•	•	•			
121-176	TC	7000		1mm					•	•	•			
121-177	TC	7000		1mm					•	•	•			
121-178	TC	Smooth		1mm					•	•	•			
121-179	TC	Smooth		1mm					•	•	•			
121-180	TC	2500				•	•	•						
121-181	TC	7000								•	•			
121-182	TC	7000								•	•			
121-183	TC	7000								•	•			
121-184	TC	7000							•	•	•			
121-185	TC	7000							•	•	•			
121-186	TC	7000							•	•	•			
121-187	TC	7000							•	•	•			
121-188	TC	7000							•	•	•			
121-189	TC	7000							•	•	•			
121-192	TC	2500				•	•	•						
121-193	TC	4000						•	•	•				
121-195	TC	2500				•	•	•						
121-196	TC	2500					•	•	•					
121-197	TC	4000							•	•				
121-198	TC	4000							•	•				
121-200	TC	2500						•	•	•				
121-205	TC	2500						•	•	•				
121-206	TC	4000						•	•	•				
121-207	TC	4000						•	•	•				
121-209	TC	2500				•	•							
121-210	TC	2500				•	•	•						
121-211	TC	4000						•	•	•				
121-212	TC	4000						•	•	•				
121-213	TC	4000						•	•	•				
121-214	TC	4000						•	•	•				
121-215	TC	4000						•	•	•				
121-216	TC	4000		2mm		•	•	•						
121-217	TC	4000		2mm		•	•	•						
121-218	TC	4000		2mm		•	•	•						
121-219	TC	4000		2mm		•	•	•						
121-220	TC	2500			•	•								
121-228	TC	Smooth		1.3mm					•	•				
121-228NL	TC	Smooth		1.3mm					•	•				
121-229	TC	7000		1.3mm					•	•				
121-229NL	TC	7000		1.3mm					•	•				
121-230	TC	Smooth		1.5mm				•	•	•				
121-230NL	TC	Smooth		1.5mm				•	•	•				
121-231	TC	7000		1.5mm				•	•	•				
121-231NL	TC	7000		1.5mm				•	•	•				



Product	Suture Size		0	2-0	3-0	4-0	5-0	6-0	7-0	8-0	9-0	10-0
	Insert	Teeth Per Square Inch Tip Width										
121-250	TC		•	•								
121-255	TC		•	•								
121-257	TC		•	•								
121-258	TC		•	•								
121-260	TC		•	•								
121-265	TC		•	•								
121-270	TC	4000		•	•	•						
121-271	TC	4000		•	•	•						
121-272	TC	4000		•	•	•						
121-273	TC	4000		•	•	•						
121-274	TC	4000		•	•	•						
124-100TI	Stardust				•	•	•					
124-101TI	Stardust				•	•	•					
124-102TI	Stardust				•	•	•					
124-105TI	Stardust	1mm					•	•	•			
124-106TI	Stardust	1mm					•	•	•			
124-108TI	Stardust	1.65mm					•	•				
124-109TI	Stardust	1.65mm					•	•				
124-110TI	Stardust	1.65mm					•	•				
277-070	Smooth	1mm					•	•	•			
277-071	Smooth	1mm					•	•	•			
277-072	Smooth	1mm					•	•	•			
277-073	Smooth	1mm					•	•	•			
277-075	Smooth	.5mm								•	•	
277-076	Smooth	.5mm								•	•	
277-090	Smooth	.7mm							•	•		
277-091	Smooth	.7mm							•	•		
277-092	Smooth	.9mm						•	•			
277-093	Smooth	.9mm						•	•			
277-094	Smooth	.7mm							•	•		
277-095	Smooth	.7mm							•	•		
277-096	Smooth	.9mm						•	•			
277-097	Smooth	.9mm						•	•			
277-140	Smooth	.8mm							•	•		
277-141	Smooth	.8mm							•	•		
277-400	Stardust	1.2mm					•	•				
277-401	Stardust	1.2mm					•	•				
277-402	Stardust	1.2mm					•	•				
277-403	Stardust	1.2mm					•	•				
277-404	Stardust	1.2mm					•	•				
277-405	Stardust	1.2mm					•	•	•			
277-406	Stardust	1.2mm					•	•				
277-407	Stardust	1.2mm					•	•				
277-408	Stardust	1.2mm					•	•	•			
277-409	Stardust	1.2mm					•	•				
277-410	Stardust	1.2mm					•	•				

Product	Suture Size		0	2-0	3-0	4-0	5-0	6-0	7-0	8-0	9-0	10-0
	Insert	Teeth Per Square Inch Tip Width										
277-411	Stardust	1.2mm					•	•				
277-412	Stardust	1.2mm					•	•	•			
277-413	Stardust	1.2mm					•	•				
277-414	Stardust	1.2mm					•	•				
277-415	Stardust	1.2mm					•	•				
278-040	Stardust	1.3mm					•	•				
278-050	Stardust	1.3mm					•	•				
278-060	Stardust	1.2mm					•	•				
278-061	Stardust	1.2mm					•	•				
278-062	Stardust	1.2mm					•	•				
278-063	Stardust	1.2mm					•	•				
278-069TI	Stardust	.8mm					•	•				
279-069TI	Stardust	1.3mm					•	•				
278-070TI	Stardust	1.3mm					•	•				
278-071TI	Stardust	1.3mm					•	•				
278-072TI	Stardust	1.3mm					•	•				
278-077TI	Stardust	1.3mm					•	•				
278-078TI	Stardust	1.3mm					•	•				
278-079TI	Stardust	1.3mm					•	•				
278-080TI	Stardust	1mm						•	•			
278-082TI	Stardust	1mm						•	•			
278-092	Stardust	1.3mm					•	•				
278-093	Stardust	1.3mm					•	•				
278-093TI	Stardust	.8mm							•	•		
278-093TI	Stardust	1.3mm					•	•				
278-094	Stardust	1.3mm					•	•				
278-095	Stardust	1.3mm					•	•				
278-095TI	Stardust	.8mm							•	•		
278-095TI	Stardust	1.3mm					•	•				
278-096	Stardust	1.3mm					•	•				
278-097	Stardust	1.3mm					•	•				
278-097TI	Stardust	.8mm							•	•		
278-100	Stardust	1.3mm					•	•				
278-101	Stardust	1.3mm					•	•				
278-102	Stardust	1.3mm					•	•				
278-103	Stardust	1.3mm					•	•				
278-104	Stardust	1.3mm					•	•				
278-105	Stardust	1.3mm					•	•				
278-108TI	Stardust	.8mm							•	•		
278-110	Stardust	1mm						•	•			
278-111	Stardust	1mm						•	•			
278-111TI	Stardust	.8mm							•	•		
278-112	Stardust	1mm						•	•			
278-113	Stardust	1mm						•	•			
278-113TI	Stardust	.8mm							•	•		
278-114	Stardust	1mm						•	•			



Product	Suture Size		0	2-0	3-0	4-0	5-0	6-0	7-0	8-0	9-0	10-0
	Insert	Teeth Per Square Inch Tip Width										
278-115	Stardust	1mm						•	•			
278-116	Stardust	1mm						•	•			
278-117	Stardust	1mm						•	•			
278-118	Stardust	1mm						•	•			
278-119	Stardust	1mm						•	•			
278-120	Stardust	1mm						•	•			
278-121	Stardust	1mm						•	•			
278-125	Stardust	2mm		•	•	•						
278-125NL	Stardust	2mm		•	•	•						
278-126	Stardust	2mm		•	•	•						
278-126NL	Stardust	2mm		•	•	•						
278-130	Stardust	2mm		•	•	•						
278-130NL	Stardust	2mm		•	•	•						
278-131	Stardust	2mm		•	•	•						
278-131NL	Stardust	2mm		•	•	•						
278-132	Stardust	2mm		•	•	•						
278-132NL	Stardust	2mm		•	•	•						
278-133	Stardust	2mm		•	•	•						
278-133NL	Stardust	2mm		•	•	•						
278-134	Stardust	2mm		•	•	•						
278-134NL	Stardust	2mm		•	•	•						
278-135	Stardust	2mm		•	•	•						
278-135NL	Stardust	2mm		•	•	•						
278-140TI	Stardust	.8mm							•	•		
278-141TI	Stardust	.8mm							•	•		
278-142TI	Stardust	.8mm							•	•		
278-143TI	Stardust	.8mm							•	•		
278-144TI	Stardust	1.3mm					•	•				
278-145TI	Stardust	1.3mm					•	•				
278-146TI	Stardust	1.3mm					•	•				
278-147TI	Stardust	1.3mm					•	•				
278-171TI	Stardust	2mm		•	•	•						
278-172TI	Stardust	2mm		•	•	•						
278-173TI	Stardust	2mm		•	•	•						
278-174TI	Stardust	2mm		•	•	•						
278-180	Stardust	1.3mm					•	•				
278-181	Stardust	1.3mm					•	•				
278-182	Stardust	1.3mm					•	•				
278-183	Stardust	1.3mm					•	•				
278-184	Stardust	1.3mm					•	•				
278-185	Stardust	1.3mm					•	•				
278-186	Stardust	1.3mm					•	•				
278-220	Stardust	.7mm							•	•	•	
278-221	Stardust	.7mm							•	•	•	
278-222	Stardust	.7mm							•	•	•	
278-223	Stardust	.7mm							•	•	•	



Product	Suture Size		0	2-0	3-0	4-0	5-0	6-0	7-0	8-0	9-0	10-0
	Insert	Teeth Per Square Inch Tip Width										
355-404		Smooth					•	•				
355-404NL		Smooth					•	•				
355-405		Smooth					•	•				
355-405NL		Smooth					•	•				
355-406		Smooth						•	•	•		
355-406NL		Smooth						•	•	•		
355-407		Smooth						•	•	•		
355-407NL		Smooth						•	•	•		
355-412	TC	Smooth						•	•			
355-412NL	TC	Smooth					•	•				
355-413	TC	7000						•	•			
355-413NL	TC	7000						•	•			

### Standard French Gauge

The standard French is used to measure diameters of all bougies, catheters, sounds, suction tubes and uterine dilators.

French Catheter Scale		
*sizes are Outside Diameter		
French	Inch	mm
3	0.039	1.0
4	0.053	1.35
5	0.066	1.67
6	0.079	2.0
7	0.092	2.3
8	0.105	2.7
9	0.118	3.0
10	0.131	3.3
11	0.144	3.7
12	0.158	4.0
13	0.170	4.3
14	0.184	4.7
15	0.197	5.0

French Catheter Scale		
*sizes are Outside Diameter		
French	Inch	mm
16	0.210	5.3
17	0.223	5.7
18	0.236	6.0
19	0.249	6.3
20	0.263	6.7
22	0.288	7.3
24	0.315	8.0
26	0.341	8.7
28	0.367	9.3
30	0.393	10.0
32	0.419	10.7
34	0.445	11.3

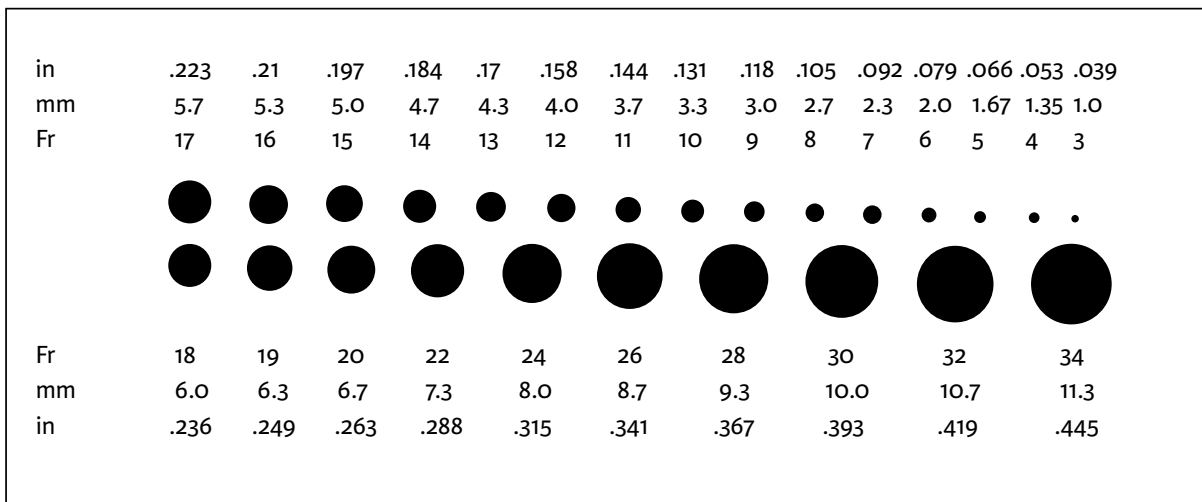

**Syringe Needle Gauge Chart**

Needle Gauge	Nominal O.D.			Nominal I.D.		
	mm	inches	tol. (in.)	mm	inches	tol. (in.)
10	3.404	0.1340	±0.0010	2.692	.1060	±0.0020
11	3.048	0.1200	"	2.388	.0940	"
12	2.769	0.1090	"	2.159	.0850	"
13	2.413	0.0950	"	1.803	.0710	"
14	2.108	0.0830	"	1.600	.0630	"
15	1.829	0.0720	±0.0005	1.372	.0540	±0.0015
16	1.651	0.0650	"	1.194	.0470	"
17	1.473	0.0580	"	1.067	.0420	"
18	1.270	0.0500	"	0.838	.0330	"
19	1.067	0.0420	"	0.686	.0270	"
20	0.902	0.0355	±0.0005	0.584	.0230	±0.0015
			-0.0000			-0.0000
21	0.813	0.0320	"	0.495	.0195	"
22	0.711	0.0280	"	0.394	.0155	"
22s	0.711	0.0280	"	0.140	.0055	"
23	0.635	0.0250	"	0.318	.0125	"
24	0.559	0.0220	"	0.292	.0115	"
25	0.508	0.0200	"	0.241	.0095	"
25s	0.508	0.0200	"	0.140	.0055	"
26	0.457	0.0180	"	0.241	.0095	"
26s	0.467	0.0184	"	0.114	.0045	"
27	0.406	0.0160	"	0.191	.0075	"
28	0.356	0.0140	"	0.165	.0065	"
29	0.330	0.0130	"	0.165	.0065	"
30	0.305	0.0120	"	0.140	.0055	"
31	0.254	0.0100	"	0.114	.0045	"
32	0.229	0.0090	"	0.089	.0035	"
33	0.203	0.0080	"	0.089	.0035	"

**Length Conversions**

Multiply	By	To Obtain
Millimeters (mm)	0.1	Centimeters (cm)
Millimeters (mm)	0.03937	Inches (")
Centimeters (cm)	0.3937	Inches (")
Centimeters (cm)	10	Millimeters (mm)
Inches (")	25.4	Millimeters (mm)
Inches (")	2.540	Centimeters (cm)

**How to Measure a Cardiovascular Instrument**

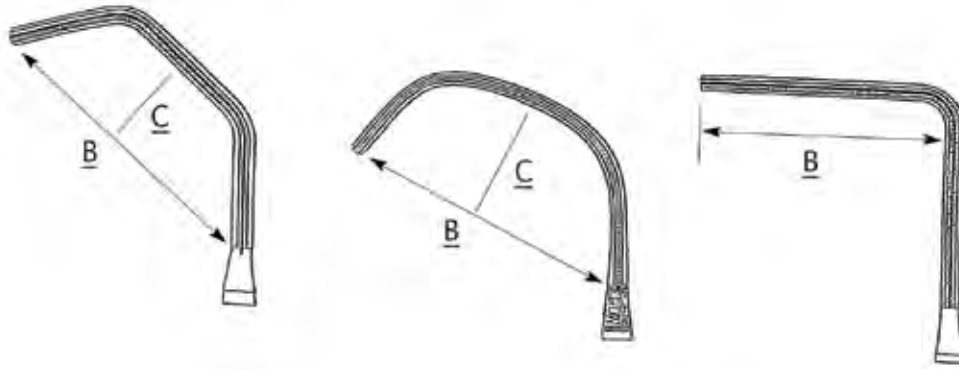

**Jaw Dimensions**

A=Overall length is measured in a straight line from the bottom of the ring handles to the farthest tip (see below)

B=jaw working length is measured in a straight line from the tip of the clamp to the end of the serrations

C=jaw depth, on an occlusion clamp is measured by drawing a straight line from the jaw tip to the end of the serrations, then finding the approximate center of the jaw and measure to the inside of the jaw

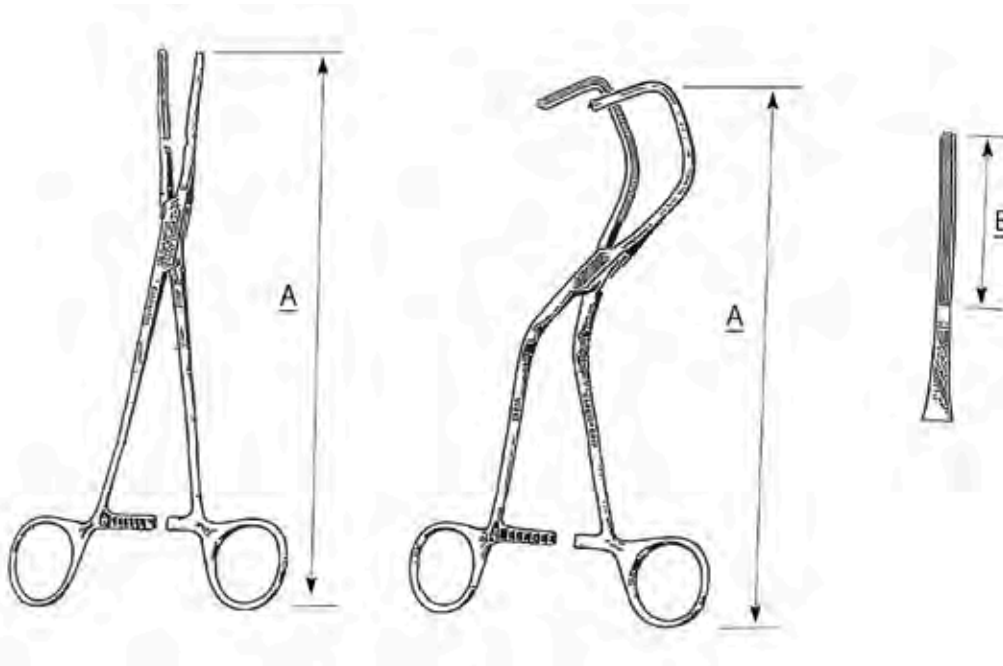

**Length**

Overall length is measured in a straight line from the bottom of the ring handles to the farthest tip (see above)

**Length**

Curved and angled instruments, the length is determined by a line drawn from the bottom of the instrument to the farthest point (see above)



## Vascular Jaw Configurations

### DeBakey Atraugrip Jaws 1 x 2 Teeth (Fig 1)

The most commonly used jaw design. Available in three sizes, Standard, Small and extra small. A single row of serrated teeth opposing a double row. Proven throughout the world for adult peripheral vascular, aortic occlusion, partial occlusion, bulldogs, pediatric clamps and vascular tissue forceps.

### DeBakey Atraugrip Jaws 2 x 3 Teeth (Fig 2)

A double row of serrated teeth opposing a triple row. A broader clamping surface for aortic cross clamping on diseased and calcified arteries. Clamps with 2 x 3 serrations are also used frequently in general surgery as bowel clamps.

### Cooley Type Teeth, 2 x 2 Teeth (Fig 3)

Two opposing rows of fine atraumatic teeth. Designed for infants and children. The jaws grasp vessels firmly with less danger of crushing. Available on a limited group of adult vascular clamps.

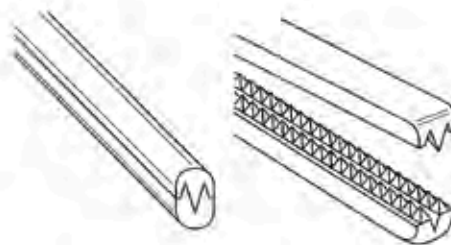

(Fig 1)

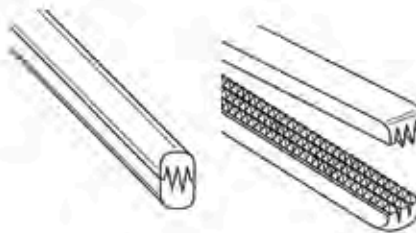

(Fig 2)

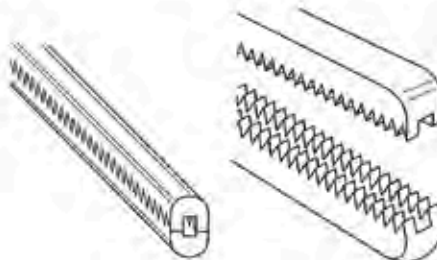

(Fig 3)



**Integra™**  
Numerical Index



099-110 ..... 2  
 099-130 ..... 3  
 099-200 ..... 5  
 099-202 ..... 5  
 099-210 ..... 5  
 099-212 ..... 5  
 099-250 ..... 7, 653  
 099-251 ..... 7, 653  
 099-262 ..... 8, 722  
 099-522 ..... 11  
 099-526 ..... 11  
 099-528 ..... 11  
 100-105 ..... 2  
 100-109 ..... 2  
 100-110 ..... 2  
 100-111 ..... 2  
 100-115 ..... 2  
 100-116 ..... 3  
 100-117 ..... 2  
 100-120 ..... 2  
 100-122 ..... 2  
 100-125 ..... 3  
 100-126 ..... 4  
 100-127 ..... 3  
 100-128 ..... 4  
 100-129 ..... 4  
 100-130 ..... 3  
 100-131 ..... 4  
 100-132 ..... 3  
 100-133 ..... 4  
 100-134 ..... 3  
 100-135 ..... 3  
 100-136 ..... 4  
 100-137 ..... 3  
 100-138 ..... 4  
 100-139 ..... 4  
 100-140 ..... 4  
 100-175 ..... 4  
 100-180 ..... 4  
 100-185 ..... 5  
 100-190 ..... 5  
 100-195 ..... 5  
 100-200 ..... 5  
 100-202 ..... 5  
 100-210 ..... 5  
 100-212 ..... 5  
 100-215 ..... 6  
 100-217 ..... 6  
 100-220 ..... 6  
 100-222 ..... 6  
 100-224 ..... 6  
 100-225 ..... 6  
 100-226 ..... 6  
 100-227 ..... 6  
 100-230 ..... 6

100-231 ..... 6  
 100-233 ..... 7, 788  
 100-240 ..... 7, 372  
 100-241 ..... 7, 372  
 100-242 ..... 7, 372  
 100-243 ..... 7, 372  
 100-244 ..... 7, 372  
 100-245 ..... 7, 372  
 100-250 ..... 7, 653  
 100-251 ..... 7, 653  
 100-260 ..... 8  
 100-261 ..... 8, 373, 654  
 100-262 ..... 8, 722  
 100-265 ..... 8  
 100-266 ..... 8, 722  
 100-269 ..... 8, 654  
 100-270 ..... 8, 654  
 100-272 ..... 9, 654  
 100-278 ..... 9, 605, 654  
 100-279 ..... 9, 605, 654  
 100-280 ..... 9, 754, 787  
 100-281 ..... 9, 754, 787  
 100-290 ..... 9, 654  
 100-291 ..... 9, 654  
 100-292 ..... 9  
 100-295 ..... 10, 373  
 100-296 ..... 10, 373  
 100-297 ..... 10, 373  
 100-298 ..... 10, 373  
 100-300 ..... 10, 373  
 100-302 ..... 10, 373  
 100-304 ..... 10, 373  
 100-306 ..... 10, 373  
 100-320 ..... 10, 655  
 100-322 ..... 10, 655  
 100-325 ..... 10, 655  
 100-327 ..... 10, 655  
 100-330 ..... 10, 655  
 100-332 ..... 10, 655  
 100-502 ..... 11  
 100-512 ..... 11  
 100-522 ..... 11  
 100-526 ..... 11  
 100-527 ..... 11  
 100-528 ..... 11  
 100-530 ..... 11  
 100-531 ..... 11  
 100-532 ..... 11  
 100-539 ..... 12, 200  
 100-540 ..... 12, 201  
 100-541 ..... 12, 201  
 100-542 ..... 12, 201  
 100-543 ..... 12, 201  
 100-544 ..... 12, 201  
 100-545 ..... 12, 201

100-546 ..... 12, 201  
 101-110 ..... 37  
 101-112 ..... 37  
 101-130 ..... 37  
 101-132 ..... 37  
 101-215 ..... 37  
 101-217 ..... 37  
 101-218 ..... 37  
 101-219 ..... 37  
 101-220 ..... 37  
 101-222 ..... 37  
 101-225 ..... 37, 371, 788  
 101-226 ..... 37, 371, 788  
 101-230 ..... 37, 371, 788,  
 ..... 794  
 101-232 ..... 37, 371, 788,  
 ..... 794  
 101-250 ..... 38, 661  
 101-251 ..... 38, 373, 661  
 101-252 ..... 38, 661  
 101-253 ..... 38, 661  
 101-255 ..... 38, 52, 374,  
 ..... 662  
 101-256 ..... 39, 369,  
 ..... 794  
 101-257 ..... 39, 662  
 101-258 ..... 39, 374, 722  
 101-259 ..... 39, 374, 662  
 101-260 ..... 39, 374, 662  
 101-261 ..... 39, 344,  
 ..... 374, 663  
 101-265 ..... 39, 374, 722  
 101-266 ..... 39, 369  
 101-267 ..... 39, 369  
 101-269 ..... 39, 369  
 101-270 ..... 39, 369  
 101-272 ..... 39, 369,  
 ..... 794  
 101-275 ..... 39, 369  
 101-276 ..... 39, 369  
 101-278 ..... 39, 369  
 101-279 ..... 39, 369  
 101-300 ..... 40, 550,  
 ..... 663  
 101-301 ..... 40, 550,  
 ..... 663  
 101-310 ..... 40, 552,  
 ..... 663  
 101-311 ..... 40, 552,  
 ..... 663  
 101-350 ..... 12, 40, 98  
 102-100 ..... 42  
 102-102 ..... 42  
 102-110 ..... 42  
 102-112 ..... 42



102-113.....	42, 371	102-311.....	47, 374	105-145.....	58, 680
102-114.....	42, 371, 788	102-313.....	48, 375	105-150.....	59
102-115.....	42, 371, 788	102-315.....	48, 376	105-151.....	59
102-116.....	42, 371, 788	102-320.....	48, 378	105-160.....	59, 681
102-118.....	42, 371, 788	102-321.....	48, 378	105-161.....	59, 681
102-119.....	42, 664	102-322.....	48, 378	105-163.....	51, 679
102-120.....	42, 374,	102-350.....	49, 380	105-164.....	51, 679
.....	664	102-351.....	49, 380	105-168.....	60
102-122.....	42, 369,	102-352.....	49, 380	105-169.....	60
.....	374, 664,	102-353.....	49, 380	105-170.....	60
.....	722	102-354.....	49, 380	105-171.....	60
102-125.....	42, 369,	102-360.....	49, 380	105-180.....	60
.....	374, 664	102-374.....	49, 381	105-181.....	60
102-126.....	42, 369, 374	103-220.....	37	105-190.....	60, 785
102-127.....	42, 369,	103-222.....	37	105-191.....	60, 785
.....	374, 794	103-250.....	38, 661	105-195.....	60, 785
102-128.....	42, 369, 374	103-251.....	38, 661	105-196.....	60, 785
102-129.....	42, 369,	103-258.....	39, 722	105-197.....	60, 785
.....	374, 794	103-261.....	39, 663	105-198.....	60, 785
102-130.....	43, 550,	105-088.....	50, 301, 678	105-199.....	60, 785,
.....	664	105-089.....	50, 301, 678	.....	798
102-131.....	43, 550,	105-090.....	50, 476,	105-200.....	61
.....	664	.....	678	105-202.....	61
102-138.....	43, 665	105-091.....	50, 476,	105-210.....	61, 786
102-139.....	43, 665	.....	678	105-212.....	61, 786
102-140.....	43, 665	105-092.....	50, 301,	105-220.....	61, 786
102-141.....	43, 665	.....	402, 476	105-222.....	61, 786
102-180.....	43, 605,	105-093.....	50, 301,	105-223.....	61, 786
.....	665, 704	.....	402, 476	105-224.....	61, 786
102-200.....	43, 665	105-095.....	50, 476,	105-225.....	61, 786
102-202.....	43, 665	.....	678	105-226.....	61, 786
102-205.....	44, 665	105-096.....	50, 476,	105-227.....	61, 786
102-210.....	44, 666	.....	678	105-228.....	61, 786, 795
102-211.....	44, 666	105-098.....	50, 301,	105-229.....	61, 786, 795
102-215.....	44, 666	.....	476, 678	105-230.....	62, 681
102-216.....	44, 666	105-099.....	50, 301,	105-232.....	62, 681
102-220.....	44, 666	.....	476, 678	105-233.....	51, 679
102-221.....	44, 666	105-100.....	55, 679	105-234.....	51, 679
102-225.....	45, 667	105-102.....	55, 679	105-235.....	402, 456,
102-226.....	45, 667	105-105.....	55	.....	476
102-229.....	45, 667	105-110.....	56, 680	105-240.....	62
102-230.....	45, 667	105-112.....	56, 680	105-242.....	62
102-231.....	45, 667	105-114.....	56, 680	105-243.....	62
102-235.....	46, 668	105-115.....	56, 680	105-245.....	62
102-236.....	46, 668	105-118.....	51, 678	105-250.....	62
102-238.....	46, 668	105-119.....	51, 678	105-251.....	62
102-240.....	46, 668	105-120.....	57	105-255.....	63, 754
102-242.....	46, 668	105-121.....	57	105-260.....	63, 427
102-245.....	47, 375, 668	105-130.....	58	105-261.....	63, 427
102-300.....	47, 373	105-131.....	58	105-262.....	63, 427
102-302.....	47, 373	105-140.....	57	105-263.....	63, 427
102-305.....	47, 372	105-141.....	57	105-270.....	63
102-306.....	47, 372	105-142.....	58, 680	105-271.....	63
102-307.....	372	105-143.....	58, 680	105-300.....	63, 403,
102-310.....	47, 344, 374	105-144.....	58, 680	.....	447, 456



105-302 ..... 63, 403,  
..... 447, 456  
105-304 ..... 63, 403,  
..... 447  
105-306 ..... 63, 403,  
..... 447  
105-320 ..... 64, 754  
105-330 ..... 64, 404  
105-331 ..... 64, 404  
105-332 ..... 64, 404  
105-340 ..... 64, 404  
105-341 ..... 64, 404  
105-342 ..... 64, 404  
106-100 ..... 55, 679  
106-102 ..... 55, 679  
106-120 ..... 57  
106-121 ..... 57  
106-130 ..... 58  
106-131 ..... 58  
106-140 ..... 57  
106-141 ..... 57  
106-150 ..... 59  
106-151 ..... 59  
106-168 ..... 60  
106-169 ..... 60  
106-170 ..... 60  
106-171 ..... 60  
106-180 ..... 60  
106-181 ..... 60  
106-190 ..... 60, 785  
106-191 ..... 60, 785  
106-195 ..... 60, 785  
106-196 ..... 60, 785  
106-200 ..... 61  
106-202 ..... 61  
106-210 ..... 61, 786  
106-212 ..... 61, 786  
106-220 ..... 61, 786  
106-222 ..... 61, 786  
106-230 ..... 62, 681  
106-232 ..... 62, 681  
107-100 ..... 55, 679  
107-102 ..... 55, 679  
107-114 ..... 56, 680  
107-115 ..... 56, 680  
107-120 ..... 57  
107-121 ..... 57  
107-130 ..... 58  
107-131 ..... 58  
107-140 ..... 57  
107-141 ..... 57  
107-170 ..... 60  
107-171 ..... 60  
107-180 ..... 60  
107-181 ..... 60

107-190 ..... 60, 785  
107-191 ..... 60, 785  
107-200 ..... 61  
107-210 ..... 61, 786  
107-220 ..... 61, 786  
109-100 ..... 65  
109-102 ..... 65  
109-119 ..... 67  
109-120 ..... 67  
110-100 ..... 65  
110-102 ..... 65  
110-105 ..... 65  
110-110 ..... 66  
110-111 ..... 66  
110-117 ..... 66  
110-118 ..... 66  
110-119 ..... 67  
110-120 ..... 67  
110-121 ..... 67  
110-150 ..... 68, 481  
110-154 ..... 68, 481  
110-155 ..... 68, 481  
110-157 ..... 68, 481  
110-159 ..... 68, 481  
110-160 ..... 69, 482  
110-161 ..... 69, 482  
110-162 ..... 69, 482  
110-164 ..... 69  
110-165 ..... 70  
110-167 ..... 70  
110-169 ..... 71  
110-170 ..... 71  
110-171 ..... 72  
110-173 ..... 72  
110-174 ..... 72  
110-175 ..... 70  
110-176 ..... 70  
110-177 ..... 71  
110-178 ..... 71  
110-180 ..... 72  
110-182 ..... 73  
110-190 ..... 73  
110-191 ..... 73  
110-194 ..... 73  
110-195 ..... 73  
110-198 ..... 73  
111-100 ..... 65  
111-102 ..... 65  
114-102 ..... 75  
114-107 ..... 75  
114-124 ..... 75, 795  
115-100 ..... 74  
115-102 ..... 74  
115-105 ..... 74  
115-107 ..... 74

115-110 ..... 74  
115-112 ..... 74  
115-115 ..... 74  
115-117 ..... 74  
115-119 ..... 75, 775  
115-120 ..... 75, 775  
116-100 ..... 74  
116-102 ..... 74  
116-105 ..... 74  
116-107 ..... 74  
116-110 ..... 74  
116-112 ..... 74  
116-115 ..... 74  
116-117 ..... 74  
117-100 ..... 811  
117-102 ..... 811  
117-106 ..... 811  
117-108 ..... 811  
117-110 ..... 811  
117-112 ..... 811  
117-114 ..... 811  
117-116 ..... 811  
117-118 ..... 811  
117-120 ..... 811  
117-130 ..... 811  
117-132 ..... 811  
117-136 ..... 811  
117-138 ..... 811  
117-140 ..... 811  
117-142 ..... 811  
117-144 ..... 811  
117-148 ..... 811  
117-160 ..... 811  
117-162 ..... 811  
117-164 ..... 811  
117-166 ..... 811  
117-168 ..... 811  
117-170 ..... 811  
117-180 ..... 812  
117-182 ..... 812  
117-184 ..... 812  
117-188 ..... 812  
117-190 ..... 812  
117-192 ..... 812  
117-194 ..... 812  
117-196 ..... 812  
117-198 ..... 812  
117-199 ..... 812  
117-240 ..... 812  
117-242 ..... 812  
117-244 ..... 812  
117-246 ..... 812  
117-247 ..... 812  
117-248 ..... 812  
117-249 ..... 812

117-250.....	813	121-106 .....	83, 673	121-181.....	89, 416
117-252.....	813	121-115 .....	83, 674	121-182 .....	89, 416
117-254.....	813	121-116.....	83, 674	121-183 .....	89, 416
117-256.....	813	121-118.....	84, 412, 674	121-184 .....	89, 416
117-258.....	813	121-119 .....	84, 412, 674	121-185 .....	89, 416
117-260 .....	813	121-120.....	84, 674	121-186.....	89, 416
117-262.....	813	121-121 .....	84, 674	121-187 .....	89, 416
117-270.....	813	121-125 .....	84	121-188 .....	89, 416
117-272 .....	813	121-126 .....	85, 412	121-189 .....	89, 416
117-274 .....	813	121-127 .....	85, 412	121-192 .....	89, 416
117-276 .....	813	121-128 .....	85, 413, 799	121-193 .....	89, 416
117-278 .....	813	121-129 .....	85, 413, 799	121-195 .....	90, 417
117-280 .....	813	121-130.....	85, 413, 675	121-196.....	90, 417
117-330.....	813	121-131.....	85, 413, 675	121-197 .....	53, 90, 417
117-340 .....	813	121-132 .....	85, 413	121-198.....	53, 90, 417
117-360 .....	815	121-133 .....	85, 413	121-200.....	90, 417
117-365.....	815	121-134 .....	85, 413	121-204 .....	91, 799
117-370.....	815	121-135 .....	86, 413	121-205 .....	90, 417
117-380 .....	815	121-140.....	86, 413	121-206.....	90, 418
117-381 .....	815	121-142 .....	86, 413	121-207 .....	90, 418
117-390 .....	815	121-143 .....	86, 413	121-209.....	91
117-391 .....	815	121-144.....	86, 413, 799	121-210.....	91
117-392 .....	815	121-145.....	86, 413	121-211.....	91, 418
118-116.....	814	121-146.....	86, 413	121-212 .....	91, 418
118-118.....	814	121-147 .....	86, 413, 799	121-213 .....	91, 418
118-119.....	814	121-148.....	52, 87, 675	121-214.....	91, 418
120-090 .....	76, 669	121-149.....	52, 87, 675	121-215.....	91, 418
120-095 .....	76, 669	121-150.....	87	121-216.....	91, 415
120-097 .....	76, 669	121-155 .....	87	121-217 .....	91, 415
120-100 .....	76, 669	121-160.....	87, 414	121-218.....	91, 415
120-105.....	77, 670	121-161.....	87, 414	121-219.....	91, 415
120-110 .....	77, 670	121-161TI .....	494	121-220 .....	92
120-112.....	77, 670	121-162 .....	87, 414	121-228 .....	92, 270,
120-115.....	77, 670	121-162TI .....	494	.....	419
120-118.....	78, 671	121-163 .....	87, 414	121-228NL .....	92, 270,
120-120.....	78, 671	121-163TI.....	494	.....	419
120-125 .....	78	121-164 .....	87, 414	121-229 .....	92, 270,
120-130 .....	78, 671	121-165 .....	87, 414	.....	419
120-131.....	78, 671	121-166.....	88, 415	121-229NL.....	92, 270,
120-132 .....	78	121-170 .....	53, 88, 414,	.....	419
120-135 .....	79	.....	675	121-230 .....	92, 270,
120-140.....	79	121-171.....	53, 88, 415,	.....	419
120-145 .....	79	.....	675	121-230NL .....	92, 270,
120-147 .....	79	121-172 .....	53, 88, 414,	.....	419
120-148 .....	52, 79, 671	.....	675	121-231 .....	92, 270,
120-149 .....	52, 79, 671	121-173 .....	53, 86, 88,	.....	419
120-150.....	79	.....	415, 675	121-231NL.....	92, 270,
120-155 .....	79	121-174 .....	53, 86, 88,	.....	419
120-180.....	79	.....	414	121-250 .....	93, 256, 419
120-200.....	80	121-175 .....	53, 88, 415	121-255.....	93, 256,
120-210.....	80	121-176 .....	53, 88, 414	.....	420
120-215 .....	80, 671	121-177 .....	53, 88, 414	121-257.....	93, 256,
121-097.....	82, 672	121-178 .....	53, 88, 415	.....	420
121-100 .....	82, 672	121-179 .....	53, 88, 415	121-258 .....	93, 256,
121-105.....	82, 672	121-180.....	88, 415	.....	420

121-260.....	93, 256,	125-117.....	97	130-166 .....	101
.....	420	125-120 .....	97	130-167.....	101
121-265 .....	93, 256,	125-122.....	97	130-170 .....	101
.....	420	125-125.....	97	130-175.....	101
121-270 .....	86, 412	125-130 .....	97	130-180 .....	101, 796
121-271 .....	86, 412	125-132.....	97	130-182 .....	101, 796
121-272.....	86, 412	125-150 .....	97, 642	130-185 .....	100
121-273.....	412	125-152.....	97, 642	130-200 .....	101
121-274.....	412	125-154.....	97, 642	130-201 .....	101
122-500 .....	95, 688	125-155.....	97, 642	130-210.....	101
122-501.....	95, 688	125-165.....	12, 98	130-211.....	101
122-502 .....	95, 688	125-170.....	12, 98	130-216 .....	101
122-503.....	95, 688	125-175 .....	13, 98	130-217 .....	101
122-510.....	95, 688	125-180 .....	13, 98	130-220 .....	101
122-520 .....	95, 393	125-182.....	13, 98	130-225.....	101
122-530.....	95, 113, 307,	125-184.....	13, 99	130-230.....	104, 304,
.....	390, 688	125-185.....	13, 99	.....	683
122-535.....	95, 113, 307,	125-190 .....	13, 99	130-231 .....	104, 304,
.....	390, 688	125-192 .....	14, 99	.....	683
122-540 .....	95, 393	125-193.....	14, 99	130-232 .....	104, 304,
122-541 .....	95, 394	125-194 .....	14, 99	.....	683
122-542.....	95, 393	125-195.....	14, 99, 555,	130-234.....	104, 304,
122-543.....	95, 394	.....	655	.....	683
122-544.....	95, 393	129-110.....	100	130-235.....	104, 304,
122-545.....	95, 394	129-115 .....	100	.....	683
122-550 .....	96, 394	129-160.....	101	130-236.....	105, 305,
122-560 .....	96	129-165 .....	101	.....	684
122-570.....	96, 393	129-230.....	104, 304,	130-237 .....	104, 304,
122-590 .....	96, 394,	.....	683	.....	683
.....	688	129-234.....	104, 304,	130-238 .....	104, 304,
122-591 .....	96, 394,	.....	683	.....	683
.....	688	129-260 .....	106, 685	130-240 .....	105, 684
122-600.....	96, 395	129-390 .....	111, 386	130-241 .....	105
122-601.....	96, 395	129-392.....	111, 386	130-243.....	105, 305,
122-602.....	96, 395	129-395.....	111, 386	.....	684
123-105 .....	82, 673	130-099.....	100	130-244.....	105, 305,
123-106.....	83, 673	130-100.....	100	.....	684
123-130.....	85, 413, 675	130-101.....	100	130-245.....	105, 305,
123-131 .....	85, 413, 675	130-105.....	100	.....	684
123-132.....	85, 413	130-110.....	100	130-246.....	106, 264,
123-135.....	86, 414	130-111.....	100	.....	305, 385
123-140 .....	86, 414	130-115 .....	100	130-247 .....	106, 264,
123-145.....	86, 414	130-116 .....	100	.....	305, 385
124-100Tl .....	493	130-117 .....	100	130-248.....	106, 264,
124-101Tl .....	493	130-120 .....	100	.....	305, 385
124-102Tl.....	493	130-125 .....	100	130-249.....	106, 264,
124-105Tl.....	493	130-130 .....	100, 795	.....	305, 385
124-106Tl .....	493	130-132 .....	100, 795	130-250 .....	106
124-108Tl.....	494	130-145 .....	100	130-255 .....	106
124-109Tl .....	494	130-150 .....	101	130-260 .....	106, 685
124-110Tl .....	494	130-151 .....	101	130-262.....	107, 685
125-100.....	97	130-155 .....	101	130-265.....	107, 385,
125-110.....	97	130-160 .....	101	.....	685
125-114 .....	97	130-161 .....	101	130-266 .....	107, 385,
125-115 .....	97	130-165 .....	101	.....	685



130-267.....	107, 385, 685	130-410.....	112, 307, 389	135-182.....	130
130-270.....	107, 685	130-415.....	112, 307, 390, 687	135-185.....	130
130-275.....	107, 305, 686	130-417.....	113, 308, 391	135-190.....	130
130-276.....	107, 305, 686	130-418.....	113, 308, 391	135-191.....	130
130-280.....	108, 306, 385, 686	130-420.....	112, 307, 389	135-194.....	130, 796
130-281.....	108, 306, 686	130-421.....	112, 307, 390	135-195.....	130
130-282.....	108, 306, 686	130-425.....	112, 307, 390	135-196.....	130, 796
130-284.....	108, 686	130-425TI.....	495, 504	135-197.....	131
130-286.....	108, 686	130-430.....	112, 307, 390	135-248.....	115, 386, 796
130-287.....	108	130-435.....	112, 307, 390	135-250.....	115, 386
130-289.....	108, 686	130-437.....	114, 387	135-252.....	115, 386
130-290.....	108, 686	130-440.....	114, 308, 391, 687	135-253.....	115, 386
130-293.....	109, 687	130-442.....	114, 308, 391, 687	135-254.....	115, 386
130-294.....	109, 687	130-445.....	111, 306, 389	135-256.....	115, 387
130-296.....	109, 387	130-446.....	112, 306, 389	135-257.....	115, 387
130-297.....	109, 387	130-500.....	125	135-258.....	115, 387
130-298.....	109, 387	130-505.....	125	135-260.....	132
130-300.....	109	130-510.....	125	135-261.....	132
130-350.....	109, 388	130-515.....	125	135-262.....	132, 795
130-352.....	110, 388	130-520.....	125	135-263.....	132, 795
130-353.....	110, 388	130-525.....	125	135-264.....	132, 795
130-355.....	109, 388	130-530.....	125	135-265.....	132, 795
130-357.....	110, 388	130-535.....	125	135-266.....	132, 795
130-358.....	110, 388	135-095.....	54, 126, 681	135-267.....	132, 795
130-360.....	109, 388	135-100.....	126	135-270.....	132
130-362.....	110, 388	135-105.....	126	135-271.....	132
130-363.....	110, 388	135-107.....	127	135-275.....	132
130-365.....	109, 388	135-109.....	126	135-276.....	132
130-366.....	110, 388	135-110.....	127	135-280.....	132
130-367.....	109, 388	135-111.....	127	135-281.....	132
130-368.....	110, 388	135-115.....	127	135-300.....	133
130-369.....	110, 388	135-120.....	127	135-301.....	133
130-370.....	110, 385, 687	135-125.....	128	135-305.....	133
130-375.....	110, 385	135-127.....	128	135-340.....	133
130-380.....	110	135-130.....	128	135-345.....	133
130-383.....	110, 388	135-135.....	128	135-350.....	133
130-390.....	111, 386	135-150.....	129	135-355.....	133
130-392.....	111, 386	135-155.....	129	135-370.....	134
130-394.....	111, 386, 796	135-175.....	129	135-375.....	134
130-395.....	111, 386	135-179.....	54, 129, 682	135-400.....	135
130-396.....	111, 386, 796	135-180.....	54, 129, 682	135-430.....	135
130-397.....	111	135-181.....	130	135-435.....	135
130-400.....	111, 306, 389			135-440.....	135
130-405.....	112, 306, 389, 687			135-445.....	135



135-605 .....	137	140-333.....	145, 403	180-233.....	152
135-615.....	131	140-335.....	145, 403,	180-234.....	152
136-100.....	126	.....	796	180-235.....	152
136-105.....	126	150-160.....	146	180-236.....	152
136-110.....	127	150-165.....	146	180-238.....	152
136-181.....	130	150-175.....	146	180-250.....	153
136-190.....	130	150-180.....	146	180-251.....	153
140-100.....	141	150-190.....	146	180-252.....	153
140-101.....	141	160-120.....	146, 430	180-253.....	153
140-102.....	141	170-100.....	147	180-255.....	153
140-103.....	141	170-101.....	147	180-260.....	153
140-104.....	141	170-102.....	147	180-261.....	153
140-105.....	141	170-103.....	147, 800	180-262.....	153
140-106.....	141	170-104.....	147, 800	180-263.....	153
140-107.....	141	170-105.....	148	180-265.....	153
140-108.....	141	170-115.....	148, 724	185-100.....	154
140-109.....	141	170-117.....	148, 800	185-105.....	154
140-154.....	141	170-118.....	148, 724	185-110.....	154
140-155.....	141	170-120.....	148, 724	185-115.....	154
140-156.....	141	170-122.....	149, 724	185-120.....	154
140-175.....	142	170-125.....	149	185-135.....	154
140-190.....	142	170-175.....	149	185-136.....	154
140-192.....	142	175-100.....	150	185-150.....	155
140-205.....	142, 407	175-105.....	150	185-152.....	155
140-206.....	142, 407	175-110.....	150	185-153.....	155
140-210.....	142	175-111.....	150	185-154.....	155
140-216.....	143, 407,	175-120.....	150	185-155.....	155
.....	456	175-121.....	150	185-156.....	155
140-217.....	143, 407,	180-100.....	151	185-157.....	155
.....	456	180-105.....	151	185-170.....	155
140-218.....	54, 143,	180-110.....	151	185-171.....	155
407, .....	456, 682	180-115.....	151	185-172.....	155
140-223.....	54, 143,	180-130.....	151	185-173.....	155
.....	408, 682	180-175.....	151	185-174.....	155
140-224.....	143, 408	180-176.....	151	185-175.....	155
140-225.....	143, 408	180-180.....	152	185-176.....	155
140-226.....	143, 408	180-182.....	152	185-179.....	155
140-228.....	142, 407	180-184.....	152	185-180.....	155
140-230.....	143, 408	180-188.....	152	185-181.....	155
140-231.....	144, 404	180-200.....	152	185-182.....	155
140-232.....	144, 403	180-201.....	152	185-183.....	155
140-233.....	144, 403	180-202.....	152	185-185.....	155
140-234.....	144, 403	180-203.....	152	185-186.....	155
140-240.....	144	180-204.....	152	185-187.....	155
140-245.....	144	180-205.....	152	185-191.....	155
140-320.....	14, 145	180-207.....	152	185-193.....	155
140-322.....	14, 145	180-222.....	152	185-196.....	156
140-329.....	145, 403,	180-223.....	152	185-201.....	156
.....	457	180-224.....	152	185-206.....	156
140-330.....	145, 302,	180-225.....	152	185-210.....	156
.....	403, 422	180-226.....	152	185-231.....	156
140-331.....	145, 302,	180-227.....	152	185-250.....	156
.....	403	180-228.....	152	185-260.....	156
140-332.....	145, 302,	180-231.....	152	189-110.....	157, 636
.....	403	180-232.....	152	189-112.....	157, 636

190-100 .....	157	200-127 .....	163	200-217 .....	173
190-101 .....	157	200-128 .....	163	200-218 .....	173
190-102 .....	157	200-130 .....	163	200-219 .....	173
190-103 .....	157	200-131 .....	163	200-220 .....	173
190-104 .....	157	200-132 .....	163	200-221 .....	173
190-105 .....	157	200-133 .....	163	200-222 .....	173
190-110 .....	157, 636	200-134 .....	164	200-223 .....	173
190-112 .....	157, 636	200-135 .....	164	200-225 .....	173
190-115 .....	158, 637	200-136 .....	164, 800	200-226 .....	173
190-116 .....	158, 637	200-137 .....	164, 800	200-227 .....	173
190-118 .....	158, 637	200-138 .....	164	200-228 .....	173
190-120 .....	158, 637	200-140 .....	165	200-235 .....	174
190-129 .....	158, 637	200-142 .....	165	200-237 .....	174
190-130 .....	159, 638	200-143 .....	165	200-255 .....	174
190-131 .....	159, 638	200-145 .....	165, 765	200-261 .....	167, 348
190-132 .....	159, 638	200-147 .....	165, 765	200-270 .....	175
190-133 .....	159, 638	200-149 .....	165, 765	200-271 .....	175
190-134 .....	159, 638	200-150 .....	165	200-272 .....	175
190-135 .....	159, 638	200-151 .....	165	200-273 .....	175
190-150 .....	160, 638	200-152 .....	165	200-280 .....	175
190-151 .....	160, 638	200-155 .....	166	200-281 .....	175
190-152 .....	160, 638	200-156 .....	166	200-282 .....	175
190-153 .....	160, 638	200-157 .....	166	200-283 .....	175
190-154 .....	160, 638	200-160 .....	167	200-290 .....	176
190-155 .....	160, 638	200-165 .....	168	200-291 .....	176
190-156 .....	160, 638	200-166 .....	168	200-292 .....	176
190-157 .....	160, 638	200-167 .....	168	200-293 .....	176
190-170 .....	160	200-168 .....	168	200-295 .....	176
190-171 .....	160	200-170 .....	169	200-296 .....	176
190-172 .....	160	200-172 .....	169	200-297 .....	176
190-173 .....	160	200-173 .....	169	200-298 .....	176
190-175 .....	160	200-175 .....	169	200-300 .....	177
190-176 .....	160	200-176 .....	169	200-301 .....	177
190-177 .....	160	200-178 .....	169	200-302 .....	177
190-178 .....	160	200-180 .....	170	200-303 .....	177
199-105 .....	161	200-181 .....	170	200-310 .....	177
199-135 .....	164	200-182 .....	170	200-311 .....	177
199-272 .....	175	200-190 .....	170	200-312 .....	177
199-282 .....	175	200-191 .....	170	200-313 .....	177
199-292 .....	176	200-192 .....	170	200-315 .....	177
199-297 .....	176	200-194 .....	170	200-318 .....	177
200-100 .....	161	200-195 .....	170	201-155 .....	166
200-105 .....	161	200-196 .....	170	201-156 .....	166
200-106 .....	161	200-197 .....	170	201-157 .....	166
200-107 .....	161	200-198 .....	171	201-160 .....	167
200-108 .....	161	200-200 .....	171	201-165 .....	168
200-109 .....	161	200-201 .....	171	201-166 .....	168
200-110 .....	162	200-202 .....	171	201-167 .....	168
200-115 .....	162	200-203 .....	171	201-168 .....	168
200-116 .....	173	200-204 .....	171, 800	201-200 .....	172
200-119 .....	162	200-205 .....	172	201-201 .....	172
200-120 .....	162	200-206 .....	172	201-202 .....	172
200-122 .....	162	200-207 .....	172	201-203 .....	172, 800
200-125 .....	162	200-208 .....	171	201-204 .....	172
200-126 .....	163	200-210 .....	172	201-205 .....	172



201-206.....	172	.....	641	205-296.....	186
201-220.....	173	205-141.....	181, 330,	205-298.....	187
201-221.....	173	.....	641	205-299.....	187
201-222.....	173	205-150.....	181, 330,	205-300.....	188
201-223.....	173	.....	641	205-305.....	188
201-225.....	173	205-151.....	181, 330,	205-310.....	188
202-155.....	166	.....	641	205-312.....	191
202-156.....	166	205-155.....	181, 330,	205-313.....	191
202-157.....	166	.....	641	205-315.....	189
202-160.....	167	205-156.....	181, 330,	205-316.....	189
202-165.....	168	.....	641	205-320.....	190
202-166.....	168	205-160.....	181, 330	205-321.....	190
202-167.....	168	205-161.....	181, 330	205-322.....	190
202-168.....	168	205-165.....	181, 330	205-323.....	190
204-120.....	178	205-166.....	181, 330	205-324.....	190
204-123.....	179, 640	205-175.....	182, 331,	205-325.....	191
204-124.....	179, 640	.....	641	205-330.....	189
204-125.....	179, 640	205-176.....	182, 331,	205-331.....	189
204-140.....	181, 330,	.....	641	205-332.....	189
.....	641	205-180.....	182, 331,	205-335.....	186
204-141.....	181, 330,	.....	641	205-336.....	186
.....	641	205-181.....	182, 331,	205-337.....	186
204-150.....	181, 330,	.....	641	205-500.....	192
.....	641	205-190.....	182, 331	205-502.....	192
204-151.....	181, 330,	205-200.....	182, 331	205-504.....	193
.....	641	205-201.....	182, 331	205-506.....	193
204-155.....	181, 330,	205-205.....	182, 331	205-508.....	193
.....	641	205-206.....	182, 331	205-510.....	193
204-156.....	181, 330,	205-209.....	182, 332	205-512.....	193
.....	641	205-210.....	182, 332	205-514.....	193
204-160.....	181, 330	205-220.....	183, 332	205-530.....	194, 348
204-161.....	181, 330	205-221.....	183, 332	205-532.....	194, 348
204-165.....	181, 330	205-225.....	183, 332	205-534.....	194, 348
204-166.....	181, 330	205-226.....	183, 332	205-536.....	194, 348
205-100.....	178, 639	205-230.....	183, 332	205-540.....	194, 195,
205-105.....	178, 639	205-235.....	183	.....	348
205-110.....	178, 640	205-237.....	183	205-542.....	194, 195,
205-111.....	178, 640	205-240.....	184, 333	.....	348
205-120.....	178	205-242.....	184, 333	205-544.....	194, 195,
205-121.....	179	205-244.....	184, 333	.....	348
205-123.....	179, 640	205-245.....	184, 333	205-550.....	195, 348
205-124.....	179, 640	205-251.....	184	205-560.....	195, 349
205-125.....	179, 640	205-255.....	184, 333	205-561.....	349
205-127.....	180	205-256.....	184, 333	205-562.....	195, 349
205-128.....	180	205-260.....	195, 349	205-563.....	195, 349
205-130.....	180	205-261.....	195, 349	205-564.....	195, 349
205-131.....	180	205-270.....	185	205-570.....	196, 349
205-132.....	180	205-275.....	185	220-100.....	200
205-133.....	180	205-280.....	185	220-105.....	200
205-134.....	180	205-290.....	186	220-110.....	200
205-135.....	180	205-291.....	186	220-115.....	200
205-136.....	180, 640	205-292.....	187	220-130.....	201
205-137.....	180, 640	205-293.....	187	220-155.....	201
205-138.....	180, 640	205-294.....	187	220-175.....	201
205-140.....	181, 330,	205-295.....	186	220-180.....	201



225-105.....	202
225-115.....	202
225-121.....	202
225-126.....	202
225-131.....	202
225-135.....	202
225-136.....	202
225-137.....	203
225-138.....	203
225-139.....	203
225-162.....	204
225-170.....	204
225-175.....	204
225-176.....	205
225-177.....	205
225-178.....	205
225-179.....	205
225-180.....	205
225-185.....	205
225-186.....	205
225-187.....	205
225-188.....	205
225-190.....	206
225-191.....	206
225-192.....	206
225-193.....	206
225-194.....	206
225-200.....	206
225-205.....	206
225-210.....	206
225-215.....	206
225-220.....	206
225-225.....	206
225-230.....	206
225-235.....	206
225-400.....	207
225-402.....	207
225-405.....	207
225-407.....	207
225-408.....	207
225-412.....	207
225-413.....	207
225-420.....	208
225-425.....	208
225-430.....	208
225-431.....	208
225-432.....	208
225-433.....	208
225-434.....	208
225-436.....	208
225-438.....	208
225-440.....	209
225-441.....	209
225-443.....	209
225-444.....	209
225-449.....	209
225-450.....	209
225-452.....	209
225-453.....	209
225-454.....	209
225-456.....	209
225-470.....	209
225-471.....	209
225-472.....	209
225-480.....	210
225-481.....	210
225-482.....	210
225-483.....	210
225-499.....	210
225-500.....	210
225-501.....	210
225-502.....	210
225-503.....	210
225-504.....	210
225-505.....	210
225-506.....	210
225-507.....	210
225-508.....	210
225-509.....	210
225-510.....	211
225-512.....	211
225-520.....	211
225-525.....	211
230-093.....	212, 576
230-095.....	212
230-096.....	212
230-097.....	212, 576
230-098.....	212, 576
230-099.....	212, 576
230-100.....	212, 576
230-102.....	212, 576
230-105.....	213, 576
230-106.....	213, 576
230-110.....	213, 577
230-111.....	213, 577
230-112.....	213, 577
230-120.....	213, 577
230-121.....	213, 577
230-122.....	213, 577
230-124.....	214, 577
230-125.....	214, 577
230-130.....	214, 578
230-131.....	214, 578
230-135.....	214, 578
230-136.....	214, 578
230-138.....	214, 578
230-142.....	214, 578
230-145.....	215, 578
230-150.....	215
230-151.....	215
230-160.....	215
230-161.....	215
230-195.....	215, 364
230-196.....	215, 364
230-197.....	215, 364
230-200.....	215, 364
230-205.....	216, 579
230-207.....	216
230-210.....	216, 365, ..... 579
230-211.....	216, 365, ..... 579
230-214.....	216, 365, ..... 579
230-215.....	216, 365, ..... 579
230-216.....	216, 365
230-218.....	217, 365
230-230.....	217, 365
230-231.....	217, 365
230-235.....	217, 365
230-236.....	217, 365
230-240.....	217, 365
230-245.....	218, 366
230-246.....	218, 366
230-247.....	218, 366
230-250.....	218, 366
230-260.....	218, 366
230-261.....	218, 366
230-262.....	218, 366
230-265.....	218
230-266.....	218
230-267.....	218
230-270.....	219
230-271.....	219
230-272.....	219
230-275.....	219, 366
230-276.....	219, 366
230-280.....	219, 366
230-300.....	220
230-301.....	220
230-302.....	220
230-305.....	220
230-306.....	220
230-310.....	220, 364, ..... 625
230-311.....	220, 364
230-315.....	220
230-320.....	221, 364
230-321.....	221, 364
230-325.....	221, 364
230-330.....	221
230-331.....	221
230-332.....	221
230-340.....	221



230-341..... 221  
 230-342 ..... 221  
 240-070 ..... 222  
 240-071 ..... 222  
 240-072 ..... 222  
 240-073 ..... 222  
 240-074 ..... 222  
 240-075 ..... 222  
 240-076 ..... 222  
 240-077 ..... 222  
 240-078 ..... 222  
 240-079 ..... 222  
 240-080 ..... 222  
 240-085 ..... 223  
 240-086 ..... 223  
 240-087 ..... 223  
 240-088 ..... 223  
 240-089 ..... 223  
 240-090 ..... 223  
 240-091 ..... 223  
 240-092 ..... 223  
 240-093 ..... 223  
 240-094 ..... 223  
 240-095 ..... 223  
 240-098 ..... 222  
 240-099 ..... 222  
 240-100 ..... 222  
 240-101 ..... 222  
 240-102 ..... 222  
 240-103 ..... 222  
 240-104 ..... 222  
 240-105 ..... 222  
 240-106 ..... 222  
 240-107 ..... 222  
 240-108 ..... 222  
 240-118 ..... 222  
 240-119 ..... 222  
 240-120 ..... 222  
 240-121 ..... 222  
 240-122 ..... 222  
 240-123 ..... 222  
 240-124 ..... 222  
 240-125 ..... 222  
 240-126 ..... 222  
 240-127 ..... 222  
 240-128 ..... 222  
 240-138 ..... 223  
 240-139 ..... 223  
 240-140 ..... 223  
 240-141 ..... 223  
 240-142 ..... 223  
 240-143 ..... 223  
 240-144 ..... 223  
 240-145 ..... 223  
 240-146 ..... 223

240-147 ..... 223  
 240-148 ..... 223  
 240-149 ..... 223  
 240-150 ..... 223  
 240-151 ..... 223  
 240-152 ..... 223  
 240-153 ..... 223  
 240-154 ..... 223  
 240-155 ..... 223  
 240-156 ..... 223  
 240-157 ..... 223  
 240-158 ..... 223  
 240-159 ..... 223  
 240-160 ..... 224  
 240-161 ..... 224  
 240-162 ..... 224  
 240-163 ..... 224  
 240-164 ..... 224  
 240-165 ..... 224  
 240-166 ..... 224  
 240-167 ..... 224  
 240-168 ..... 224  
 240-170 ..... 224  
 240-171 ..... 224  
 240-172 ..... 224  
 240-175 ..... 224  
 240-176 ..... 224  
 240-177 ..... 224  
 240-178 ..... 224  
 240-179 ..... 224  
 240-180 ..... 224  
 240-181 ..... 224  
 240-182 ..... 224  
 240-183 ..... 224  
 240-185 ..... 224  
 240-186 ..... 224  
 240-187 ..... 224  
 240-188 ..... 224  
 240-189 ..... 224  
 240-190 ..... 224  
 240-191 ..... 224  
 240-192 ..... 224  
 240-193 ..... 224  
 240-195 ..... 225  
 240-196 ..... 225  
 240-197 ..... 225  
 240-198 ..... 225  
 240-200 ..... 225  
 240-202 ..... 225  
 240-203 ..... 225  
 240-205 ..... 225  
 240-207 ..... 225  
 240-208 ..... 225  
 240-209 ..... 225  
 240-210 ..... 226

240-211 ..... 226  
 240-212 ..... 226  
 240-214 ..... 226  
 240-215 ..... 226  
 240-216 ..... 226  
 240-220 ..... 226  
 240-221 ..... 226  
 240-230 ..... 226  
 240-231 ..... 226  
 240-232 ..... 226  
 250-084 ..... 227, 816  
 250-090 ..... 227, 816  
 250-092 ..... 227, 816  
 250-093 ..... 227, 816  
 250-095 ..... 228, 817  
 250-097 ..... 228, 817  
 250-099 ..... 228, 817  
 250-100 ..... 229  
 250-101 ..... 229  
 250-102 ..... 229  
 250-103 ..... 229  
 250-104 ..... 229  
 250-105 ..... 229  
 250-106 ..... 229  
 250-107 ..... 229  
 250-108 ..... 229  
 250-109 ..... 229  
 250-120 ..... 229  
 250-121 ..... 229  
 250-122 ..... 229  
 250-123 ..... 229  
 250-124 ..... 229  
 250-125 ..... 229  
 250-126 ..... 229  
 250-127 ..... 229  
 250-128 ..... 229  
 250-129 ..... 229  
 250-140 ..... 229  
 250-141 ..... 229  
 250-142 ..... 229  
 250-143 ..... 229  
 250-144 ..... 229  
 250-145 ..... 229  
 250-146 ..... 229  
 250-147 ..... 229  
 250-148 ..... 229  
 250-149 ..... 229  
 250-160 ..... 230  
 250-161 ..... 230  
 250-162 ..... 230  
 250-163 ..... 230  
 250-164 ..... 230  
 250-165 ..... 230  
 250-166 ..... 230  
 250-167 ..... 230

250-168.....	230
250-169.....	230
250-180.....	230
250-181.....	230
250-182.....	230
250-183.....	230
250-184.....	230
250-185.....	230
250-186.....	230
250-187.....	230
250-188.....	230
250-189.....	230
250-190.....	230
250-191.....	230
250-192.....	230
250-193.....	230
250-194.....	230
250-195.....	230
250-196.....	230
250-197.....	230
250-198.....	230
250-199.....	230
250-200.....	231
250-201.....	231
250-202.....	231
250-203.....	231
250-204.....	231
250-205.....	231
250-206.....	231
250-210.....	231
250-211.....	231
250-212.....	231
250-213.....	231
250-214.....	231
250-215.....	231
250-216.....	231
250-220.....	231
250-221.....	231
250-222.....	231
250-223.....	231
250-224.....	231
250-225.....	231
250-226.....	231
250-230.....	231
250-231.....	231
250-232.....	231
250-233.....	231
250-234.....	231
250-235.....	231
250-236.....	231
250-240.....	232
250-241.....	232
250-242.....	232
250-243.....	232
250-244.....	233
250-245.....	233
250-246.....	233
250-247.....	233
250-248.....	233
250-250.....	234
250-251.....	234
250-252.....	234
250-253.....	234
250-254.....	234
250-255.....	234
250-260.....	234
250-261.....	234
250-262.....	234
250-263.....	234
250-264.....	234
250-265.....	234
250-280.....	234
250-281.....	234
250-282.....	234
250-283.....	234
250-284.....	234
250-285.....	234
250-286.....	234
250-290.....	234
250-291.....	234
250-292.....	234
250-293.....	234
250-294.....	234
250-295.....	234
250-296.....	234
250-320.....	235
250-321.....	235
250-322.....	235
250-323.....	235
250-330.....	235
250-331.....	235
250-332.....	235
250-333.....	235
250-335.....	235
250-336.....	235
250-337.....	235
250-338.....	235
250-380.....	236, 817
250-381.....	236
250-382.....	236
250-383.....	236
250-384.....	236
250-385.....	236
250-386.....	236
250-387.....	236
250-390.....	236
250-391.....	237
250-392.....	237
250-393.....	237
250-394.....	237
250-395.....	237
250-396.....	237
250-397.....	237
250-398.....	237, 646
250-399.....	237, 646
250-400.....	238
250-403.....	238
250-404.....	238
250-405.....	238
250-406.....	238
250-408.....	238
250-410.....	237, 646
250-411.....	239
250-412.....	239
250-415.....	239
250-416.....	239
250-418.....	239
250-420.....	240
250-421.....	240
250-422.....	240
250-423.....	240
250-424.....	240
250-425.....	240
250-426.....	240
250-430.....	239
250-431.....	239
250-432.....	239
250-433.....	239
250-434.....	239
250-435.....	239
250-436.....	239
250-470.....	240
250-471.....	240
250-472.....	240
250-480.....	240
250-481.....	240
250-482.....	240
250-483.....	240
250-490.....	241
250-492.....	241
250-495.....	241
250-496.....	241
250-500.....	242
250-502.....	242
250-503.....	242
250-504.....	242
250-505.....	242
250-506.....	242
250-509.....	242, 580
250-510.....	242
251-240.....	232
251-241.....	232
251-242.....	232
251-243.....	232
251-244.....	233



251-245.....	233	275-503.....	257	277-092.....	266
251-246.....	233	275-504.....	257	277-093.....	266
255-100.....	243	275-505.....	257	277-094.....	266
255-110.....	243	275-510.....	258	277-095.....	266
255-111.....	243	275-515.....	258	277-096.....	266
255-112.....	243	275-525.....	258	277-097.....	266
260-104.....	244	275-530.....	258	277-100.....	267
260-105.....	244	275-540.....	259	277-101.....	267
260-106.....	244	275-550.....	259	277-103.....	267
260-109.....	244	275-555.....	260	277-104.....	267
260-110.....	244	275-560.....	260	277-110.....	267
260-112.....	244	275-561.....	260	277-111.....	267
260-116.....	343	275-563.....	235	277-115.....	267
260-117.....	343	275-565.....	260	277-116.....	267
260-118.....	343	275-570.....	261	277-120.....	268, 382
260-120.....	244	275-580.....	261	277-121.....	268, 382
260-121.....	244	275-589.....	261	277-122.....	268, 382
260-135.....	245	275-590.....	261	277-123.....	268, 382
260-160.....	245	275-591.....	261	277-124.....	268, 382
260-200.....	245	275-594.....	262	277-130.....	268, 383
260-201.....	245	275-595.....	262	277-131.....	268, 383
260-205.....	245	275-596.....	262	277-132.....	268, 383
260-210.....	245	275-600.....	262	277-135.....	268, 383
270-120.....	246	277-040.....	264, 398	277-136.....	268, 383
270-121.....	246	277-041.....	264, 398	277-140.....	269
270-122.....	246	277-042.....	264, 398	277-141.....	269
270-150.....	14, 246	277-043.....	264, 398	277-145.....	269
270-157.....	246	277-044.....	264, 398	277-147.....	269
270-165.....	247	277-045.....	264, 398	277-159.....	116, 270
270-170.....	247	277-046.....	264, 398	277-160.....	116, 270
270-175.....	247	277-047.....	264, 398	277-161.....	116, 270
270-176.....	247	277-049.....	264, 398	277-162.....	116, 270
270-180.....	247	277-050.....	265	277-200.....	271
270-182.....	248	277-051.....	265	277-202.....	271
270-183.....	248	277-053.....	265	277-204.....	271
270-185.....	248	277-054.....	265	277-206.....	271
270-186.....	248	277-056.....	265	277-210.....	271
270-187.....	249	277-057.....	265	277-211.....	271
270-188.....	249	277-058.....	265, 382	277-212.....	271
270-189.....	249	277-059.....	265, 382	277-213.....	271
270-195.....	249	277-060.....	265	277-215.....	271
270-196.....	249	277-061.....	265	277-217.....	272
270-197.....	249	277-062.....	265	277-220.....	272
270-198.....	249	277-065.....	265	277-221.....	272
270-200.....	249	277-066.....	265	277-222.....	272
270-225.....	249	277-070.....	266	277-225.....	272
275-125.....	255	277-071.....	266	277-235.....	273
275-126.....	255	277-072.....	266	277-236.....	273
275-135.....	255	277-073.....	266	277-237.....	273
275-140.....	256	277-075.....	266	277-238.....	273
275-145.....	256	277-076.....	266	277-240.....	274
275-155.....	257	277-080.....	264, 398	277-241.....	274
275-500.....	257	277-081.....	264, 398	277-244.....	274
275-501.....	257	277-090.....	266	277-245.....	274
275-502.....	257	277-091.....	266	277-250.....	274

277-251 .....	274	277-401.....	418	.....	502
277-252 .....	274	277-402 .....	418	278-112.....	280
277-253 .....	274	277-403 .....	418	278-113.....	280
277-260 .....	275	277-404 .....	418	278-113TI .....	282, 496,
277-260TI.....	275, 500	277-405 .....	419	.....	502
277-261 .....	275	277-406 .....	418	278-114.....	280
277-261TI.....	275, 500	277-407 .....	418	278-115.....	280
277-262 .....	275	277-408 .....	419	278-116.....	280
277-262TI.....	275, 500	277-409.....	418	278-117.....	280
277-263.....	275	277-410.....	418	278-118.....	280
277-263TI .....	275, 500	277-411.....	418	278-119.....	280
277-264 .....	275	277-412 .....	419	278-120.....	280
277-264TI.....	275, 500	277-413 .....	418	278-121.....	280
277-265.....	275	277-414 .....	418	278-125 .....	282
277-265TI.....	276, 500	277-415 .....	418	278-125NL.....	282
277-266 .....	275	278-040.....	281	278-126 .....	282
277-266TI.....	276, 500	278-050.....	281	278-126NL.....	282
277-267.....	275	278-060 .....	281	278-130 .....	283
277-267TI .....	276, 500	278-061 .....	281	278-130NL.....	283
277-268 .....	276	278-062.....	281	278-131.....	283
277-268TI.....	276, 500	278-063.....	281	278-131NL.....	283
277-269 .....	276	278-069TI .....	497	278-132 .....	283
277-269TI.....	276, 500	278-070TI .....	497	278-132NL.....	283
277-270.....	276	278-071TI.....	497	278-133 .....	283
277-270TI.....	276, 500	278-072TI.....	497	278-133NL.....	283
277-271 .....	276	278-077TI.....	497	278-134 .....	283
277-271TI.....	276, 500	278-078TI.....	497	278-134NL.....	283
277-272.....	277	278-079TI.....	497	278-135 .....	283
277-272TI .....	277, 501	278-080TI .....	282, 496,	278-135NL.....	283
277-273.....	277	.....	502	278-140TI .....	496
277-273TI.....	277, 501	278-082TI .....	282, 496,	278-141TI .....	496
277-274.....	277	.....	502	278-142TI .....	496
277-274TI.....	278, 501	278-092.....	279	278-143TI.....	497
277-275.....	278, 818	278-093.....	279	278-144TI .....	497
277-275TI .....	278, 501,	278-093TI.....	282, 496,	278-145TI.....	497
.....	818	.....	502	278-146TI .....	497
277-276TI .....	278, 501	278-094.....	279	278-147TI.....	497
277-277TI .....	278, 501	278-095.....	279	278-171TI .....	497
277-278TI .....	278, 501	278-095TI .....	282, 496,	278-172TI.....	497
277-279TI .....	278, 501	.....	502	278-173TI.....	497
277-290 .....	278	278-096.....	279	278-174TI.....	497
277-291 .....	278	278-097.....	279	278-180.....	281
277-292 .....	278	278-097TI.....	282, 496,	278-181.....	281
277-295.....	278	.....	502	278-182 .....	281
277-330 .....	269, 384	278-100 .....	279	278-183 .....	281
277-331 .....	269, 384	278-101 .....	279	278-184 .....	281
277-332.....	269, 384	278-102.....	279	278-185 .....	281
277-333.....	269, 384	278-103.....	279	278-186 .....	281
277-334.....	269, 384	278-104.....	279	278-220 .....	547
277-335.....	269, 383	278-105.....	279	278-221 .....	547
277-336.....	269, 383	278-108TI .....	282, 496,	278-222 .....	547
277-337.....	269, 383	.....	502	278-223.....	547
277-338.....	269, 383	278-110 .....	280	279-083TI.....	503
277-339.....	269, 383	278-111 .....	280	279-084TI .....	503
277-400.....	418	278-111TI.....	282, 496,	279-088TI .....	503

279-089TI .....	503	280-059 .....	288	280-297 .....	293
279-093TI .....	503	280-060 .....	289	280-298 .....	293
279-094TI .....	503	280-060DT .....	291	280-380 .....	294
279-097TI .....	503	280-060TF .....	290	280-381 .....	294
279-098TI .....	503	280-061 .....	289	280-382 .....	294
279-100 .....	284, 285,	280-061DT .....	291	280-383 .....	294
.....	399	280-061TF .....	290	280-384 .....	294
279-100TI .....	286, 505	280-062 .....	289	280-385 .....	294
279-101 .....	284, 399	280-062DT .....	291	280-386 .....	295
279-101TI .....	286, 505	280-062TF .....	290	280-387 .....	295
279-102 .....	284, 399	280-063 .....	289	280-388 .....	295
279-102TI .....	286, 505	280-063DT .....	291	280-400 .....	294
279-105 .....	284, 399	280-063TF .....	290	280-401 .....	294
279-106 .....	284, 399	280-064 .....	289	280-402 .....	294
279-107 .....	284, 399	280-160 .....	291	280-405 .....	294
279-110 .....	400	280-161 .....	291	280-406 .....	294
279-110TI .....	286, 498,	280-162 .....	291	280-407 .....	294
.....	505	280-163 .....	291	280-410 .....	294
279-111 .....	285, 400	280-164 .....	291	280-411 .....	294
279-111TI .....	286, 498,	280-199 .....	291	280-412 .....	294
.....	505	280-200 .....	291	280-415 .....	294
279-112 .....	285, 400	280-201 .....	291	280-416 .....	294
279-112TI .....	286, 498,	280-202 .....	291	280-417 .....	294
.....	505	280-203 .....	291	280-420 .....	295
279-113 .....	285, 400	280-209 .....	292	280-421 .....	295
279-114 .....	285, 400	280-210 .....	292	280-422 .....	295
279-115 .....	285, 400	280-211 .....	292	280-425 .....	295
279-116 .....	285, 400	280-212 .....	292	280-426 .....	295
279-117 .....	285, 400	280-213 .....	292	280-427 .....	295
279-118 .....	285, 400	280-219 .....	292	280-430 .....	296
279-119 .....	285, 400	280-220 .....	292	280-431 .....	296
279-120 .....	285, 400	280-221 .....	292	280-432 .....	296
279-121 .....	285, 400	280-222 .....	292	280-440 .....	296
279-122 .....	285, 400	280-223 .....	292	280-441 .....	296
279-125 .....	285, 399	280-229 .....	292	280-442 .....	296
279-130 .....	285, 400	280-230 .....	292	280-450 .....	297, 620
279-131 .....	285, 400	280-231 .....	292	280-451 .....	297, 620
279-149 .....	284, 399	280-232 .....	292	280-452 .....	297, 620
279-150 .....	284, 399	280-233 .....	292	280-454 .....	297, 620
279-150TI .....	504	280-234 .....	293	280-460 .....	298
279-151TI .....	504	280-235 .....	293	280-465 .....	298
279-158 .....	285, 399	280-236 .....	293	280-466 .....	298
279-159 .....	285, 399	280-237 .....	293	280-467 .....	298
280-040 .....	288	280-238 .....	293	280-470 .....	298
280-040DT .....	291	280-239 .....	292	280-500 .....	299
280-041 .....	289	280-240 .....	292	280-501 .....	299
280-050 .....	288	280-241 .....	292	280-502 .....	299
280-051 .....	288	280-242 .....	292	280-503 .....	299
280-052 .....	288	280-243 .....	292	280-504 .....	299
280-053 .....	288	280-286 .....	293	280-505 .....	299
280-054 .....	288	280-288 .....	293	280-510 .....	299
280-055 .....	288	280-290 .....	293	280-511 .....	299
280-056 .....	288	280-292 .....	293	280-512 .....	299
280-057 .....	288	280-295 .....	293	280-514 .....	299
280-058 .....	288	280-296 .....	293	280-515 .....	299

280-516 .....	299	281-452.....	297	.....	392
280-517.....	299	282-060 .....	289	285-126 .....	117, 309,
280-530.....	299	282-061 .....	289	.....	392
280-550.....	300	282-062.....	289	285-127 .....	117, 309,
280-551 .....	300	282-063.....	289	.....	392
280-552 .....	300	282-064.....	289	285-128 .....	116, 309,
280-553 .....	300	282-405.....	294	.....	392
280-554 .....	300	282-406.....	294	285-129 .....	117, 309,
280-555.....	300	282-407 .....	294	.....	392
280-556.....	300	282-415.....	294	285-130.....	117, 309,
280-557.....	300	282-416.....	294	.....	392
280-558.....	300	282-417.....	294	285-131TI .....	504
280-559.....	300, 818	282-425 .....	295	285-132 .....	309, 392
281-040.....	288	282-426 .....	295	285-132TI.....	504
281-040DT.....	291	282-427 .....	295	285-135 .....	309, 392
281-041.....	289	282-450.....	297	285-140.....	117, 309
281-050 .....	288	282-451.....	297	285-147 .....	117, 310
281-051.....	288	282-452.....	297	285-148 .....	117, 310
281-052 .....	288	283-060 .....	289	285-170.....	117, 310
281-053.....	288	283-061 .....	289	285-171.....	117, 310
281-054 .....	288	283-062.....	289	285-172 .....	117, 310
281-055 .....	288	283-063.....	289	285-185 .....	311
281-056 .....	288	283-064.....	289	285-186 .....	311
281-057.....	288	283-239 .....	292	285-187 .....	311
281-058 .....	288	283-240 .....	292	285-188 .....	311
281-059 .....	288	283-241.....	292	285-189.....	311
281-060.....	289	283-242 .....	292	285-190 .....	312
281-060DT.....	291	283-243.....	292	285-191 .....	312
281-060TF .....	290	284-060 .....	289	285-192.....	312
281-061.....	289	284-061.....	289	285-193 .....	312
281-061DT.....	291	284-062.....	289	285-199.....	312
281-061TF .....	290	284-063.....	289	285-200.....	315
281-062 .....	289	284-064.....	289	285-202 .....	315
281-062DT.....	291	285-100 .....	301	285-205.....	315
281-062TF.....	290	285-101 .....	301	285-210.....	315
281-063 .....	289	285-103.....	302, 479	285-215.....	315
281-063DT .....	291	285-104.....	302, 479	285-219.....	315
281-063TF.....	290	285-105.....	302, 479	285-220 .....	315
281-064 .....	289	285-106 .....	302, 479	285-221.....	315
281-239.....	292	285-107.....	51, 302, 476	285-225.....	316, 368
281-240.....	292	285-108.....	51, 302, 476	285-227.....	316, 368
281-241 .....	292	285-110 .....	303	285-230 .....	316, 368
281-242 .....	292	285-111 .....	303	285-233.....	316
281-243 .....	292	285-112.....	303	285-235.....	316
281-405 .....	294	285-114.....	303	285-236 .....	316
281-406 .....	294	285-115.....	303	285-240 .....	316
281-407.....	294	285-116.....	116, 306	285-315 .....	317, 368
281-415 .....	294	285-117.....	116, 306	285-318.....	317
281-416 .....	294	285-118.....	116, 306	285-320 .....	317
281-417.....	294	285-119 .....	116, 306	285-325.....	317
281-425.....	295	285-120.....	116, 309,	285-327.....	317
281-426.....	295	.....	392	285-330 .....	317
281-427.....	295	285-121.....	116, 309	285-331 .....	317
281-450 .....	297	285-122 .....	116, 309	285-340.....	318
281-451 .....	297	285-125 .....	117, 309,	285-342 .....	318



285-345 .....	318, 613	.....	702	286-106 .....	122, 313
285-346 .....	318, 613	285-452 .....	326, 702	286-107 .....	123, 314
285-350 .....	318	285-453 .....	326, 702	286-108 .....	123, 314
285-351 .....	318	285-454 .....	326, 702	286-109 .....	123, 314
285-352 .....	318	285-455 .....	326, 702	286-110 .....	124, 314
285-353 .....	318	285-456 .....	326, 702	286-111 .....	124, 314
285-355 .....	318	285-457 .....	326, 702	286-112 .....	124, 314
285-357 .....	318	285-458 .....	326, 702	290-100 .....	329, 590
285-360 .....	319	285-460 .....	326	290-101 .....	329, 590
285-361 .....	319	285-461 .....	326	290-102 .....	329, 590
285-362 .....	319	285-462 .....	326	290-120 .....	329
285-365 .....	319	285-463 .....	326	290-122 .....	329
285-366 .....	319	285-464 .....	326	290-125 .....	329
285-367 .....	319	285-465 .....	326	290-145 .....	333
285-368 .....	319, 368	285-466 .....	326	290-150 .....	334
285-369 .....	319	285-470 .....	326	290-152 .....	334
285-370 .....	320	285-471 .....	326	290-153 .....	334
285-375 .....	320	285-472 .....	326	290-166 .....	334
285-376 .....	320	285-473 .....	326	290-175 .....	334
285-379 .....	320, 368,	285-474 .....	326	290-176 .....	334
.....	612, 702	285-475 .....	326	290-177 .....	334
285-380 .....	320, 368,	285-476 .....	326	290-180 .....	335
.....	612, 702	285-477 .....	327	290-181 .....	335
285-381 .....	320	285-478 .....	327	290-190 .....	335
285-382 .....	320	285-479 .....	327	290-200 .....	335
285-383 .....	321	285-480 .....	327, 586	290-210 .....	336
285-384 .....	321	285-482 .....	327, 586	290-211 .....	336
285-385 .....	322	285-484 .....	327, 586	290-212 .....	336
285-386 .....	322	285-490 .....	327	290-213 .....	336
285-388 .....	322	285-492 .....	327	290-214 .....	336
285-389 .....	322	285-495 .....	327	290-215 .....	337
285-390 .....	322	285-496 .....	327	290-216 .....	337
285-391 .....	323	285-497 .....	327	290-217 .....	337
285-394 .....	323	285-498 .....	327	290-218 .....	337
285-395 .....	323	285-499 .....	327	290-220 .....	336
285-396 .....	323	285-530 .....	328	290-221 .....	337
285-397 .....	323	285-531 .....	328	290-222 .....	337
285-398 .....	324	285-533 .....	328	290-225 .....	337
285-405 .....	324	285-534 .....	328	290-226 .....	337
285-411 .....	324	285-540 .....	328	290-227 .....	337
285-412 .....	324	285-541 .....	328	290-230 .....	337
285-420 .....	324	285-542 .....	328	290-231 .....	337
285-421 .....	324	285-543 .....	328	290-232 .....	337
285-422 .....	324	285-544 .....	328	290-233 .....	337
285-425 .....	325	285-545 .....	328	290-234 .....	337
285-430 .....	325	285-546 .....	328	290-235 .....	337
285-431 .....	325	285-547 .....	328	290-236 .....	337
285-433 .....	325	285-550 .....	328	290-237 .....	337
285-434 .....	325	285-551 .....	328	290-238 .....	337
285-435 .....	325	286-100 .....	121, 313	290-240 .....	338
285-449 .....	326, 586,	286-101 .....	121, 313	290-241 .....	338
.....	702	286-102 .....	121, 313	290-242 .....	338
285-450 .....	326, 586,	286-103 .....	121, 313	290-244 .....	338
.....	702	286-104 .....	121, 313	290-245 .....	338
285-451 .....	326, 586,	286-105 .....	122, 313	290-246 .....	338



290-251 .....	338
290-260 .....	339
290-261 .....	339
290-262 .....	339
290-263 .....	339
290-264 .....	339
290-265 .....	339
290-266 .....	339
290-267 .....	339
290-268 .....	339
290-280 .....	339
290-281 .....	339
290-282 .....	339
290-283 .....	339
290-284 .....	339
290-285 .....	339
290-286 .....	339
290-287 .....	339
290-288 .....	339
290-300 .....	340
290-305 .....	340
290-310 .....	341
290-315 .....	341
290-320 .....	341
290-321 .....	341
290-322 .....	341
290-323 .....	341
290-324 .....	341
290-325 .....	341
290-330 .....	341
290-331 .....	341
290-332 .....	341
290-333 .....	341
290-334 .....	341
290-335 .....	341
295-110 .....	342
295-111 .....	342
295-112 .....	342
295-113 .....	342
295-114 .....	342
295-115 .....	342
295-116 .....	342
295-117 .....	342
295-130 .....	343
295-131 .....	343
295-132 .....	343
295-140 .....	343
295-145 .....	343
295-150 .....	343
295-175 .....	343
295-200 .....	15, 344
295-205 .....	15, 344
295-210 .....	15, 344
295-211 .....	15, 344
295-215 .....	15, 344
295-220 .....	15, 344
295-221 .....	15, 344
295-295 .....	432
295-296 .....	432
300-100 .....	350
300-105 .....	350
300-115 .....	350
300-150 .....	353
300-151 .....	353
300-160 .....	355
300-165 .....	355
300-166 .....	355
300-175 .....	353
300-180 .....	354
300-183 .....	354
300-185 .....	355
300-190 .....	358
300-192 .....	358
300-194 .....	358
300-200 .....	350
300-202 .....	350
300-205 .....	356
300-210 .....	352
300-211 .....	352
300-213 .....	352
300-225 .....	351
300-230 .....	359
300-231 .....	359
300-235 .....	359
300-238 .....	359
300-250 .....	356
300-251 .....	356
300-253 .....	357
300-260 .....	357
300-261 .....	357
300-262 .....	357
300-300 .....	362
300-302 .....	362
300-304 .....	362
300-305 .....	362
300-310 .....	362
300-315 .....	363
300-316 .....	363
300-400 .....	367
300-402 .....	367
300-405 .....	367
300-407 .....	367
300-410 .....	367
300-411 .....	367
300-415 .....	367
300-416 .....	367
300-425 .....	367
300-450 .....	346
300-451 .....	346
305-100 .....	16, 369
305-101 .....	16, 369
305-105 .....	16, 369
305-106 .....	16, 369
305-110 .....	16, 369
305-120 .....	16, 370
305-125 .....	16, 370
305-130 .....	16, 370
305-131 .....	16, 370
305-135 .....	16, 370
305-136 .....	16, 370
305-140 .....	16, 370, 787
305-141 .....	16, 370, 787
305-145 .....	16, 370
305-146 .....	16, 370
305-200 .....	401
305-205 .....	401
305-210 .....	401
305-215 .....	401
305-220 .....	401
305-230 .....	402
305-231 .....	402, 797
305-233 .....	402, 797
305-294 .....	402
305-295 .....	402
305-296 .....	402
305-297 .....	402
305-300 .....	404
305-305 .....	404
305-306 .....	404
305-308 .....	405
305-309 .....	405
305-310 .....	405
305-320 .....	405
305-325 .....	405
305-330 .....	405
305-332 .....	405
305-337 .....	405
305-350 .....	405
305-351 .....	405
305-352 .....	405
305-355 .....	406
305-359 .....	406
305-360 .....	406
305-362 .....	406
305-363 .....	406
305-365 .....	406
305-366 .....	406, 797
305-367 .....	406
305-368 .....	406
305-369 .....	406, 797
305-370 .....	407
305-372 .....	407
305-373 .....	407
305-380 .....	408
305-385 .....	409

305-386.....	409	310-305.....	377	310-392.....	424
305-388.....	409	310-306.....	377	310-393.....	424
305-389.....	409	310-307.....	377	310-394.....	424
305-390.....	409	310-308.....	377	310-395.....	424
305-395.....	409, 798	310-309.....	377	310-396.....	424
305-396.....	409, 798	310-310.....	19, 378	310-397.....	424
305-397.....	409	310-315.....	19, 378	310-398.....	424
305-398.....	410, 798	310-320.....	19, 378	310-399.....	424
305-399.....	410, 798	310-330.....	18, 376	310-400.....	424
305-400.....	410	310-332.....	19, 378	310-401.....	424
305-401.....	410	310-333.....	19, 378	310-402.....	424
305-402.....	410	310-334.....	19, 378	310-403.....	424
305-403.....	410	310-340.....	19, 379	310-404.....	424
305-405.....	410	310-341.....	19, 379	310-405.....	425, 819
305-406.....	410	310-342.....	19, 379	310-406.....	425, 821
305-407.....	410	310-343.....	19, 379	310-407.....	425, 821
305-408.....	410	310-344.....	19, 379	310-410.....	425
305-431.....	410	310-345.....	19, 379	310-411.....	425
305-441.....	411	310-349.....	18, 376	310-412.....	425
305-450.....	411, 453	310-350.....	20, 379,	310-413.....	425
305-451.....	411, 453	.....	422	310-414.....	425
305-498.....	411	310-351.....	20, 379	310-415.....	425
305-499.....	411	310-352.....	20, 379,	310-416.....	425
305-500.....	411	.....	422	310-420.....	346
305-501.....	411	310-353.....	20, 379,	310-424.....	346
310-103.....	421	.....	422	310-430.....	427
310-105.....	421	310-354.....	20, 379	310-431.....	427
310-108.....	421	310-355.....	21, 381	310-432.....	427
310-110.....	421	310-356.....	21, 381	310-433.....	427
310-112.....	421	310-357.....	21, 381	310-436.....	427
310-140.....	347	310-358.....	21, 381	310-440.....	427
310-141.....	347	310-360.....	20, 380,	310-441.....	427
310-142.....	347	.....	482	310-442.....	427
310-143.....	347	310-367.....	18, 376	310-445.....	427
310-144.....	347	310-368.....	18, 376	310-450.....	426
310-145.....	347	310-369.....	18, 376	310-451.....	426
310-150.....	346	310-370.....	18, 376	310-452.....	426
310-151.....	346	310-374.....	21, 381	310-453.....	426
310-152.....	346	310-375.....	18, 377	310-454.....	426
310-155.....	346	310-376.....	18, 377	310-455.....	426
310-190.....	453	310-377.....	422	310-456.....	426
310-191.....	453	310-378.....	423	310-457.....	426
310-192.....	453	310-379.....	423	310-458.....	426
310-193.....	453	310-380.....	422	310-459.....	426
310-200.....	442	310-381.....	422, 819	310-460.....	426
310-202.....	442	310-382.....	423	310-461.....	426
310-204.....	442	310-383.....	422, 423	310-462.....	426
310-214.....	449	310-384.....	423	310-465.....	426, 820
310-290.....	17, 375	310-385.....	422, 424	310-480.....	427
310-291.....	17, 375	310-386.....	424	310-481.....	427
310-292.....	17, 375	310-387.....	424	310-482.....	427
310-300.....	17, 375	310-388.....	424	310-485.....	428
310-302.....	17, 375	310-389.....	424	310-486.....	428
310-303.....	17, 375	310-390.....	424	310-487.....	428
310-304.....	18, 377	310-391.....	424	310-488.....	428



310-490.....	346	320-100.....	103, 397	320-171.....	486
310-491.....	346	320-101.....	103, 397	320-172.....	422, 486
310-492.....	346	320-102.....	103, 397	320-172ST.....	486
310-493.....	346	320-103.....	103, 397	320-173.....	486
310-494.....	346	320-104.....	103, 397	320-174.....	486
310-495.....	346	320-105.....	102, 396	320-175.....	486
310-500.....	347	320-106.....	102, 396	320-175ST.....	486
310-502.....	347	320-107.....	102, 396	320-177.....	486
310-505.....	347	320-108.....	102, 396,	320-178.....	486
310-506.....	347	.....	797	320-179.....	485
310-507.....	347	320-109.....	102, 396,	320-180.....	448
310-508.....	347	.....	797	320-182.....	448
310-520.....	428	320-110.....	102, 396	320-185.....	448
310-522.....	428	320-111.....	102, 396	320-187.....	448
310-528.....	387	320-111TI.....	495	320-190.....	448
310-530.....	429	320-112.....	102, 396	320-192.....	458
310-532.....	429	320-113.....	102, 396	320-193.....	458
310-533.....	429	320-113TI.....	498	320-194.....	458
310-535.....	21, 381	320-114.....	102, 396,	320-195.....	458
310-540.....	382	.....	422	320-196.....	458
310-542.....	382	320-114TI.....	498	320-197.....	458
310-544.....	429	320-115.....	102, 396	320-198.....	458
310-545.....	429	320-115TI.....	498	320-199.....	465
310-547.....	429	320-116.....	103, 397	320-200.....	452
310-549.....	430	320-117.....	103, 397	320-205.....	452
310-550.....	430	320-118.....	103, 397	320-209.....	446
310-551.....	430	320-119.....	103, 397	320-210.....	446
310-570.....	430	320-120.....	482	320-211.....	446
310-575.....	431	320-122.....	483	320-212.....	446
310-576.....	431	320-125.....	482	320-213.....	446
310-580.....	431	320-127.....	483	320-214.....	446
311-350.....	20, 379	320-130.....	482	320-215.....	445
311-351.....	20, 379	320-132.....	483	320-216.....	445
311-352.....	20, 379	320-135.....	482	320-217.....	445
311-353.....	20, 379	320-137.....	483	320-218.....	451, 471
311-354.....	20, 379	320-140.....	483	320-220.....	451
320-050.....	102, 396	320-141.....	484	320-221.....	451
320-051.....	102, 396	320-142.....	483	320-222.....	451
320-052.....	102, 396	320-143.....	484	320-223.....	452
320-065.....	485	320-144.....	483	320-225.....	451
320-066.....	485	320-145.....	484	320-226.....	451
320-067.....	485	320-146.....	483	320-227.....	451
320-068.....	485	320-147.....	484	320-228.....	64, 403,
320-070.....	103, 397	320-148.....	483	.....	447, 478
320-071.....	103, 397	320-150.....	484	320-229.....	64, 403,
320-072.....	103, 397	320-152.....	484	.....	447, 478
320-073.....	103, 397	320-155.....	484	320-230.....	448
320-074.....	103, 397	320-157.....	484	320-231.....	448
320-080TI.....	498	320-160.....	484	320-233.....	450
320-081TI.....	498	320-162.....	484	320-234.....	450
320-082TI.....	498	320-165.....	484	320-235.....	450
320-083TI.....	495	320-167.....	484	320-236.....	450
320-084TI.....	495	320-168.....	485	320-238.....	449
320-085TI.....	495	320-169.....	485	320-239.....	449
320-099.....	102, 396	320-170.....	422, 486	320-240.....	449



320-241..... 449  
 320-242 ..... 438  
 320-243 ..... 438  
 320-244 ..... 438  
 320-245 ..... 437  
 320-246 ..... 438  
 320-247 ..... 439  
 320-248 ..... 439  
 320-249 ..... 439  
 320-250 ..... 446  
 320-255 ..... 446  
 320-257 ..... 436  
 320-258 ..... 436  
 320-259 ..... 437  
 320-260 ..... 447  
 320-261 ..... 470  
 320-262 ..... 452  
 320-263 ..... 436  
 320-264 ..... 437  
 320-265 ..... 447, 467  
 320-266 ..... 436  
 320-267 ..... 437  
 320-268 ..... 437  
 320-269 ..... 437  
 320-270 ..... 444  
 320-272 ..... 444  
 320-274 ..... 411  
 320-275 ..... 444  
 320-276 ..... 444  
 320-277 ..... 444  
 320-280 ..... 434  
 320-282 ..... 434  
 320-284 ..... 434  
 320-286 ..... 434  
 320-287 ..... 435  
 320-288 ..... 434  
 320-289 ..... 435  
 320-290 ..... 435  
 320-291 ..... 435  
 320-292 ..... 435  
 320-293 ..... 435  
 320-294 ..... 435  
 320-296 ..... 441  
 320-297 ..... 441  
 320-298 ..... 441  
 320-300 ..... 445  
 320-302 ..... 445  
 320-304 ..... 445  
 320-306 ..... 445  
 320-310 ..... 452  
 320-312 ..... 452  
 320-314 ..... 452  
 320-316 ..... 452  
 320-320 ..... 440  
 320-322 ..... 440

320-324 ..... 440  
 320-326 ..... 440  
 320-328 ..... 440  
 320-335 ..... 441  
 320-336 ..... 441  
 320-337 ..... 441  
 320-338 ..... 441  
 320-339 ..... 441  
 320-340 ..... 139  
 320-341 ..... 139  
 320-342 ..... 139  
 320-343 ..... 139  
 320-344 ..... 139  
 320-345 ..... 139  
 320-346 ..... 139  
 320-347 ..... 139  
 320-350 ..... 140  
 320-351 ..... 140  
 320-352 ..... 140  
 320-353 ..... 140  
 320-354 ..... 140  
 320-355 ..... 140  
 320-357 ..... 437  
 320-360 ..... 443  
 320-361 ..... 443  
 320-362 ..... 443  
 320-363 ..... 443  
 320-370 ..... 443  
 320-372 ..... 443  
 320-375 ..... 442  
 320-380 ..... 443  
 320-381 ..... 443  
 320-382 ..... 443  
 320-383 ..... 443  
 320-390 ..... 441  
 320-391 ..... 441  
 320-392 ..... 441  
 320-395 ..... 450  
 320-396 ..... 450  
 320-397 ..... 449  
 320-398 ..... 449  
 320-399 ..... 449  
 320-400 ..... 465  
 320-401 ..... 465  
 320-403 ..... 466  
 320-405 ..... 466  
 320-406 ..... 466  
 320-410 ..... 466  
 320-411 ..... 466  
 320-412 ..... 466  
 320-413 ..... 466  
 320-414 ..... 466  
 320-415 ..... 471  
 320-416 ..... 459  
 320-417 ..... 459

320-418 ..... 459  
 320-420 ..... 473  
 320-422 ..... 473  
 320-425 ..... 473  
 320-430 ..... 474  
 320-431 ..... 474  
 320-432 ..... 474  
 320-433 ..... 475  
 320-435 ..... 474  
 320-436 ..... 474  
 320-437 ..... 474  
 320-438 ..... 434  
 320-440 ..... 472  
 320-441 ..... 472  
 320-445 ..... 472  
 320-446 ..... 472  
 320-447 ..... 440  
 320-448 ..... 440  
 320-449 ..... 440  
 320-450 ..... 459  
 320-451 ..... 459  
 320-452 ..... 459  
 320-453 ..... 465  
 320-454 ..... 465  
 320-455 ..... 465  
 320-456 ..... 465  
 320-457 ..... 465  
 320-460 ..... 458  
 320-461 ..... 458  
 320-462 ..... 458  
 320-463 ..... 475  
 320-464 ..... 475  
 320-465 ..... 475  
 320-466 ..... 475  
 320-467 ..... 475  
 320-470 ..... 467  
 320-471 ..... 467  
 320-472 ..... 444  
 320-473 ..... 444  
 320-474 ..... 467  
 320-475 ..... 467  
 320-476 ..... 467  
 320-480 ..... 451  
 320-481 ..... 451  
 320-482 ..... 451  
 320-483 ..... 442  
 320-484 ..... 442  
 320-485 ..... 442, 473  
 320-486 ..... 442, 473  
 320-487 ..... 471  
 320-490 ..... 471  
 320-494 ..... 438  
 320-495 ..... 438  
 320-500 ..... 469  
 320-501 ..... 469

320-502.....	469	320-637.....	477	350-112.....	509
320-503.....	469	320-638.....	477	350-118.....	510
320-504.....	469	320-639.....	477	350-119.....	510
320-505.....	469	320-640.....	477	350-120.....	510
320-506.....	472	320-641.....	477	350-121.....	510
320-507.....	472	320-642.....	477	350-125.....	510
320-508.....	472	320-643.....	477	350-126.....	510
320-510.....	358	320-644.....	477	350-140.....	511
320-514.....	358	320-650.....	457, 477	350-142.....	511
320-515.....	358	320-651.....	457, 477	350-144.....	511
320-516.....	358	320-652.....	457, 477	350-149.....	511
320-517TI.....	351, 499	320-700TI.....	461, 488	350-150.....	511
320-518.....	351	320-701TI.....	461, 488	350-151.....	511
320-520.....	470	320-702TI.....	461, 488	350-152.....	511
320-525.....	470	320-703TI.....	462, 489	350-153.....	511
320-530.....	470	320-704TI.....	462, 489	350-155.....	512
320-535.....	470	320-705TI.....	463, 490	350-160.....	512
320-540.....	468	320-706TI.....	463, 490	350-210.....	512
320-540TI.....	468, 492	320-707TI.....	464, 491	350-250.....	512
320-542.....	468	320-708TI.....	461, 488	350-255.....	512
320-542TI.....	468, 492	320-709TI.....	462, 489	350-256.....	512
320-550.....	480	320-710TI.....	462, 489	350-260.....	512
320-555.....	480	320-711TI.....	463, 490	350-290.....	513
320-560.....	481	320-712TI.....	464, 491	350-292.....	513
320-562.....	481	320-713TI.....	464, 491	350-294.....	513
320-564.....	481	320-728TI.....	439, 492	350-300.....	514
320-566.....	481	320-800.....	460	350-301.....	514
320-568.....	481	320-801.....	460	350-302.....	514
320-570.....	481	320-802.....	460	350-303.....	514
320-572.....	481	320-803.....	460	350-304.....	514
320-600.....	459	320-804.....	460	350-305.....	514
320-601.....	459	320-810.....	460	350-310.....	514
320-602.....	459	320-811.....	460	350-320.....	514
320-603.....	459	320-812.....	460	350-321.....	514
320-604.....	475	320-813.....	460	350-322.....	515
320-610.....	474	320-814.....	460	350-325.....	515
320-611.....	474	325-140.....	137	350-330.....	515
320-612.....	474	325-141.....	137	350-340.....	516
320-615.....	479	325-142.....	138	350-341.....	516
320-616.....	479	325-143.....	138	350-344.....	516
320-617.....	479	325-144.....	138	350-345.....	516
320-618.....	479	325-150.....	134	350-347.....	516
320-620.....	478	325-151.....	134	350-348.....	516
320-621.....	478	350-090.....	508	350-349.....	516
320-622.....	478	350-092.....	508	350-350.....	517
320-625.....	479	350-093.....	508	350-351.....	422, 517
320-626.....	479	350-094.....	508	350-352.....	517
320-627.....	479	350-095.....	508	350-353.....	517
320-630.....	457, 477	350-096.....	508	350-354.....	517
320-631.....	457, 477	350-097.....	508	350-355.....	517
320-632.....	457, 477	350-098.....	509	350-357.....	517
320-633.....	457, 477	350-100.....	509	350-360.....	518, 630
320-634.....	457, 477	350-101.....	509	350-362.....	518
320-635.....	477	350-105.....	509	350-363.....	518
320-636.....	477	350-110.....	509	350-365.....	518

350-366 .....	518	355-132 .....	528	355-206 .....	538
350-368 .....	519	355-135 .....	528	355-210 .....	538
350-369 .....	519	355-137 .....	529	355-212 .....	538
350-370 .....	519, 630	355-138 .....	529	355-214 .....	539
350-371 .....	519, 630	355-140 .....	529	355-215 .....	539
350-372 .....	519	355-141 .....	529	355-218 .....	539
350-377 .....	520	355-142 .....	530	355-220 .....	539
350-380 .....	520	355-143 .....	530	355-225 .....	540
350-381 .....	520	355-144 .....	530	355-226 .....	540
350-383 .....	520	355-145 .....	530	355-230 .....	540
350-384 .....	520	355-146 .....	530	355-235 .....	540
350-385 .....	521	355-147 .....	530	355-250 .....	541
350-387 .....	521	355-148 .....	531	355-255 .....	541
350-390 .....	521	355-150 .....	531	355-260 .....	541
350-392 .....	521	355-151 .....	531	355-263 .....	541
350-395 .....	521	355-152 .....	531	355-265 .....	541
350-397 .....	522	355-155 .....	531	355-280 .....	542
350-398 .....	522	355-156 .....	531	355-285 .....	542
350-400 .....	522	355-159 .....	532	355-300 .....	543
350-405 .....	522	355-160 .....	532	355-303 .....	543
350-410 .....	522	355-161 .....	532	355-305 .....	543
350-415 .....	523	355-162 .....	532	355-310 .....	543
350-420 .....	523	355-163 .....	532	355-311 .....	543
350-425 .....	523	355-165 .....	532	355-312 .....	543
350-430 .....	523	355-166 .....	532	355-315 .....	544
350-435 .....	523	355-168 .....	532	355-320 .....	544
350-440 .....	524	355-169 .....	532	355-340 .....	544
350-441 .....	524	355-170 .....	533	355-341 .....	544
350-445 .....	524	355-170TI .....	506, 534	355-350 .....	545
355-090 .....	118, 525	355-171 .....	533	355-360 .....	545
355-091 .....	118, 525	355-171TI .....	506, 534	355-370 .....	545
355-092 .....	118, 525	355-172 .....	533	355-375 .....	545
355-095 .....	118, 526	355-173 .....	533	355-376 .....	545
355-096 .....	118, 526	355-174 .....	533	355-377 .....	545
355-097 .....	118, 526	355-175 .....	533	355-378 .....	545
355-100 .....	118, 525	355-175TI .....	506, 534	355-380 .....	545
355-101 .....	118, 525	355-177 .....	535	355-400 .....	546
355-102 .....	118, 525	355-178 .....	535	355-404 .....	546, 676
355-110 .....	118, 526	355-179 .....	535	355-404NL .....	546, 676
355-111 .....	118, 526	355-180 .....	535	355-405 .....	546, 676
355-112 .....	118, 526	355-181 .....	535	355-405NL .....	546, 676
355-115 .....	526	355-182 .....	535	355-406 .....	546, 676
355-116 .....	526	355-183 .....	536	355-406NL .....	546, 676
355-117 .....	527	355-184 .....	535	355-407 .....	546, 676
355-118 .....	527	355-185 .....	536	355-407NL .....	546, 676
355-119 .....	527	355-187 .....	536	355-408 .....	546, 677
355-120 .....	527	355-188 .....	536	355-409 .....	546, 677
355-121 .....	527	355-189 .....	536	355-410 .....	546, 677
355-122 .....	527	355-191 .....	536	355-411 .....	546, 677
355-123 .....	527	355-192 .....	536	355-412 .....	547, 677
355-125 .....	527	355-193 .....	537	355-412NL .....	547, 677
355-126 .....	527	355-200 .....	537	355-413 .....	547, 677
355-128 .....	527	355-202 .....	537	355-413NL .....	547, 677
355-130 .....	528	355-203 .....	537	355-415 .....	547
355-131 .....	528	355-205 .....	538	355-416 .....	547



355-430 .....	547	360-126 .....	24, 551, 658	360-199 .....	557
355-432 .....	547	360-127 .....	24, 552,	360-200 .....	557
355-434 .....	547	.....	659	360-201 .....	557
355-436 .....	547	360-128 .....	24, 552,	360-202 .....	557
355-450 .....	548	.....	659	360-203 .....	557
355-451 .....	548	360-130 .....	25, 552,	360-205 .....	558
355-452 .....	548	.....	659	360-206 .....	558
355-453 .....	548	360-131 .....	25, 552,	360-215 .....	558
355-460 .....	548	.....	659	360-220 .....	558
355-462 .....	548	360-134 .....	25, 552,	360-225 .....	558
355-464 .....	548	.....	659	360-234 .....	558
355-466 .....	548	360-135 .....	25, 552,	360-250 .....	558
355-470 .....	548	.....	659	360-251 .....	559
355-472 .....	548	360-138 .....	25, 553, 659	360-253 .....	559
355-475 .....	548	360-139 .....	25, 553, 659	360-255 .....	559
359-100 .....	22, 549,	360-140 .....	25, 553, 659	360-260 .....	559
.....	656	360-141 .....	25, 553, 659	360-262 .....	559
359-101 .....	22, 549,	360-142 .....	25, 553,	360-270 .....	560
.....	656	.....	660	360-271 .....	560
360-090 .....	22, 549,	360-143 .....	25, 553,	360-272 .....	560
.....	656	.....	660	360-273 .....	560
360-091 .....	22, 549,	360-144 .....	553	360-274 .....	560
.....	656	360-145 .....	553	360-275 .....	560
360-092 .....	22, 549,	360-146 .....	553	360-276 .....	560
.....	656	360-147 .....	553	360-280 .....	560
360-093 .....	22, 549,	360-148 .....	26, 554,	360-281 .....	560
.....	656	.....	660	360-282 .....	560
360-094 .....	22, 549,	360-149 .....	26, 554,	360-283 .....	560
.....	656	.....	660	360-284 .....	560
360-095 .....	22, 549,	360-150 .....	554	360-285 .....	560
.....	656	360-151 .....	26, 554	360-286 .....	560
360-100 .....	22, 549,	360-153 .....	26, 554	360-287 .....	560
.....	656	360-154 .....	27, 555,	360-288 .....	560
360-101 .....	22, 549,	.....	660	360-289 .....	560
.....	656	360-155 .....	27, 555,	360-290 .....	560
360-102 .....	23, 550,	.....	660	360-291 .....	560
.....	657	360-156 .....	27, 555	360-300 .....	560
360-103 .....	23, 550,	360-157 .....	26, 554	360-301 .....	560
.....	657	360-158 .....	555	360-302 .....	560
360-104 .....	23, 550,	360-159 .....	555	360-305 .....	561
.....	657	360-160 .....	555	360-307 .....	561
360-105 .....	23, 550,	360-161 .....	555	360-310 .....	561
.....	657	360-165 .....	556	360-315 .....	561
360-110 .....	23, 550,	360-170 .....	556	360-316 .....	561
.....	657	360-172 .....	556	360-325 .....	561
360-111 .....	23, 550,	360-175 .....	556	360-326 .....	561
.....	657	360-180 .....	556	360-330 .....	562
360-115 .....	23, 551, 657	360-181 .....	556	360-331 .....	562
360-117 .....	23, 551, 658	360-190 .....	556	360-502 .....	562, 820
360-118 .....	23, 551, 658	360-191 .....	556	360-504 .....	562, 820
360-120 .....	24, 551, 658	360-192 .....	557	360-512 .....	562, 820
360-121 .....	24, 551, 658	360-193 .....	557	360-514 .....	562, 820
360-122 .....	24, 551, 658	360-195 .....	27, 557	375-020 .....	564
360-123 .....	24, 551, 658	360-196 .....	557	375-022 .....	564
360-125 .....	24, 551, 658	360-198 .....	557	375-024 .....	564



375-026 .....	564	380-150 .....	567	380-271 .....	574
375-028 .....	564	380-153 .....	568	380-272 .....	574
375-030 .....	564	380-155 .....	568	380-273 .....	574
375-032 .....	564	380-156 .....	568	380-275 .....	574
375-034 .....	564	380-157 .....	568	380-276 .....	574
375-036 .....	564	380-165 .....	569	380-277 .....	574
375-040 .....	564	380-166 .....	569	380-300 .....	575
375-042 .....	564	380-167 .....	569	380-301 .....	575
375-044 .....	564	380-168 .....	569	380-302 .....	575
375-046 .....	564	380-169 .....	569	380-303 .....	575
375-048 .....	564	380-175 .....	570	380-305 .....	575
375-050 .....	564	380-180 .....	570	380-307 .....	575
375-052 .....	564	380-181 .....	570	380-315 .....	580
375-054 .....	564	380-182 .....	570	380-320 .....	580
375-056 .....	564	380-183 .....	570	380-321 .....	580
375-100 .....	564	380-184 .....	570	380-323 .....	580
375-101 .....	564	380-190 .....	570	380-325 .....	581
375-102 .....	564	380-191 .....	570	380-330 .....	581
375-103 .....	564	380-192 .....	570	380-335 .....	582
375-104 .....	564	380-193 .....	570	380-336 .....	582
375-110 .....	564	380-194 .....	570	380-340 .....	582
375-111 .....	564	380-200 .....	570	380-350 .....	582
375-112 .....	564	380-201 .....	570	380-355 .....	583
375-113 .....	564	380-202 .....	570	380-356 .....	583
375-114 .....	564	380-203 .....	570	380-360 .....	583
375-130 .....	565	380-204 .....	570	380-362 .....	583
375-131 .....	565	380-210 .....	570	380-365 .....	583
375-132 .....	565	380-211 .....	570	380-366 .....	583
375-133 .....	565	380-212 .....	570	380-367 .....	583
375-134 .....	565	380-213 .....	570	385-025 .....	584
375-140 .....	565	380-214 .....	570	385-030 .....	584
375-141 .....	565	380-215 .....	571	385-031 .....	584
375-142 .....	565	380-216 .....	571	385-032 .....	584
375-143 .....	565	380-217 .....	571	385-033 .....	584
375-144 .....	565	380-218 .....	571	385-034 .....	584
375-150 .....	565	380-219 .....	571	385-035 .....	584
375-151 .....	565	380-220 .....	571	385-036 .....	584
375-152 .....	565	380-221 .....	571	385-037 .....	584
375-153 .....	565	380-222 .....	571	385-038 .....	584
375-154 .....	565	380-224 .....	571	385-039 .....	584
375-160 .....	565	380-225 .....	571	385-040 .....	584
375-161 .....	565	380-226 .....	571	385-041 .....	584
375-162 .....	565	380-227 .....	571	385-042 .....	584
375-163 .....	565	380-230 .....	572	385-043 .....	584
375-164 .....	565	380-231 .....	572	385-044 .....	584
380-100 .....	119, 566	380-232 .....	572	385-045 .....	584
380-105 .....	119, 566	380-233 .....	572	385-046 .....	584
380-110 .....	119, 566	380-235 .....	573	385-047 .....	584
380-140 .....	566	380-236 .....	573	385-048 .....	584
380-141 .....	566	380-237 .....	573	385-049 .....	584
380-143 .....	567	380-238 .....	573	385-050 .....	585
380-145 .....	567	380-239 .....	573	385-051 .....	585
380-146 .....	567	380-242 .....	573	385-052 .....	585
380-147 .....	567	380-244 .....	574	385-054 .....	585
380-149 .....	567	380-270 .....	574	385-055 .....	585



385-056.....	585	385-317.....	593	400-135.....	601, 703
385-058.....	585	385-320.....	593	400-136.....	602, 703
385-060.....	585	385-321.....	593	400-140.....	602
385-062.....	585	385-326.....	593	400-141.....	602
385-080.....	586	385-327.....	593	400-142.....	602
385-082.....	586	385-330.....	594	400-143.....	602
385-084.....	586	385-335.....	594	400-144.....	602
385-100.....	587	385-340.....	594	400-145.....	602
385-102.....	587	385-345.....	594	400-146.....	602
385-104.....	587	385-346.....	594	400-150.....	119, 603
385-106.....	587	385-347.....	594	400-152.....	120, 603
385-108.....	587	385-348.....	594	400-155.....	120, 603
385-110.....	587	385-350.....	595	400-160.....	604
385-115.....	587	385-351.....	595	400-161.....	604
385-120.....	587	385-352.....	595	400-170.....	604
385-121.....	587	385-353.....	595	400-171.....	604
385-125.....	587	385-354.....	595	400-175.....	604
385-126.....	587	385-355.....	595	400-177.....	28, 605
385-127.....	587	385-356.....	595	400-180.....	28, 605,
385-130.....	587	385-360.....	596	.....	703
385-140.....	588	385-361.....	596	400-185.....	606
385-142.....	588	385-362.....	596	400-187.....	606
385-144.....	588	385-370.....	596	400-200.....	607
385-146.....	588	385-371.....	596	400-220.....	607
385-148.....	588	385-380.....	596	400-222.....	607
385-200.....	588	385-382.....	597	400-223.....	607
385-202.....	588	385-384.....	597	400-225.....	607
385-204.....	588	385-386.....	597	400-226.....	607
385-206.....	588	385-388.....	597	400-230.....	608
385-210.....	588	385-390.....	598	400-234.....	608
385-211.....	588	385-392.....	598	400-235.....	608
385-212.....	588	385-400.....	598	400-236.....	608
385-220.....	588	385-401.....	598	400-237.....	608
385-221.....	588	385-402.....	598	400-240.....	609
385-223.....	589	385-430.....	599	400-241.....	609
385-224.....	589	385-440.....	599	400-242.....	609
385-240.....	589	385-500.....	599	400-243.....	609
385-242.....	589	385-505.....	599	400-245.....	609
385-245.....	589	385-506.....	599	400-247.....	609
385-246.....	589	400-100.....	600	400-250.....	609
385-250.....	589	400-101.....	600	400-253.....	610
385-252.....	589	400-102.....	600	400-255.....	610
385-257.....	590	400-105.....	600	400-257.....	610
385-258.....	590	400-110.....	600, 703	400-258.....	610
385-260.....	591	400-112.....	600	400-260.....	610
385-262.....	591	400-115.....	601	400-261.....	610
385-265.....	591	400-116.....	601	400-262.....	610
385-266.....	591	400-117.....	601	400-263.....	610
385-270.....	159, 591	400-120.....	601	400-264.....	610
385-280.....	592	400-121.....	601	400-265.....	610
385-285.....	592	400-122.....	601	400-269.....	611
385-305.....	592	400-130.....	601, 703	400-270.....	611
385-310.....	592	400-131.....	601, 703	400-271.....	611
385-315.....	592	400-132.....	601, 703	400-272.....	611
385-316.....	592	400-134.....	601, 703	400-273.....	611, 704



400-274 ..... 612  
 400-275 ..... 612  
 400-276 ..... 612  
 400-277 ..... 613, 704  
 400-278 ..... 613  
 400-279 ..... 613  
 400-280 ..... 614  
 400-281 ..... 614  
 400-282 ..... 614  
 400-285 ..... 614  
 400-286 ..... 615  
 400-287 ..... 615  
 400-288 ..... 615  
 400-290 ..... 615  
 400-292 ..... 615  
 400-293 ..... 616  
 400-294 ..... 616  
 400-296 ..... 616  
 400-297 ..... 616  
 400-298 ..... 617  
 400-299 ..... 617  
 400-300 ..... 617  
 400-301 ..... 617  
 400-302 ..... 617  
 400-303 ..... 617  
 400-304 ..... 617  
 400-305 ..... 617  
 400-306 ..... 617  
 400-307 ..... 618, 704  
 400-308 ..... 618, 704  
 400-320 ..... 618  
 400-321 ..... 618  
 400-322 ..... 618  
 405-100 ..... 619  
 405-105 ..... 619  
 405-106 ..... 619  
 405-108 ..... 619  
 405-110 ..... 620  
 405-111 ..... 620  
 405-112 ..... 620  
 405-115 ..... 621  
 405-116 ..... 621  
 405-118 ..... 621  
 405-120 ..... 621  
 405-122 ..... 622  
 405-125 ..... 622  
 405-130 ..... 622  
 405-131 ..... 622  
 405-150 ..... 623  
 405-152 ..... 623  
 405-153 ..... 623  
 405-155 ..... 623  
 405-180 ..... 623  
 405-181 ..... 624  
 405-182 ..... 624

405-183 ..... 624  
 405-184 ..... 624  
 405-186 ..... 624  
 405-190 ..... 625  
 405-192 ..... 625  
 405-200 ..... 626  
 405-201 ..... 626  
 405-210 ..... 626  
 405-225 ..... 626  
 410-100 ..... 628  
 410-101 ..... 628  
 410-105 ..... 628  
 410-106 ..... 628  
 410-110 ..... 628  
 410-111 ..... 628  
 410-115 ..... 628  
 410-116 ..... 628  
 410-120 ..... 628  
 410-121 ..... 628  
 410-123 ..... 629  
 410-125 ..... 629  
 410-128 ..... 629  
 410-130 ..... 629  
 410-135 ..... 630  
 410-136 ..... 630  
 410-137 ..... 630  
 410-140 ..... 630  
 410-145 ..... 630  
 410-146 ..... 630  
 410-147 ..... 630  
 410-150 ..... 631  
 410-151 ..... 631  
 410-152 ..... 631  
 410-153 ..... 631  
 410-154 ..... 631  
 410-157 ..... 631  
 410-160 ..... 631  
 410-161 ..... 631  
 410-163 ..... 631  
 410-165 ..... 632  
 410-166 ..... 632  
 410-167 ..... 632  
 410-170 ..... 632  
 410-180 ..... 632  
 410-182 ..... 632  
 410-183 ..... 632  
 410-185 ..... 633  
 410-186 ..... 633  
 410-187 ..... 633  
 410-193 ..... 633  
 410-194 ..... 633  
 410-195 ..... 633  
 410-196 ..... 633  
 410-197 ..... 634  
 410-198 ..... 634

410-199 ..... 634  
 410-200 ..... 634  
 410-201 ..... 634  
 410-202 ..... 634  
 410-203 ..... 634  
 410-205 ..... 635  
 410-207 ..... 635  
 410-210 ..... 635  
 410-211 ..... 635  
 410-212 ..... 635  
 410-215 ..... 636  
 410-218 ..... 636  
 410-220 ..... 159, 638  
 410-225 ..... 158, 639  
 410-226 ..... 158, 639  
 410-230 ..... 159, 639  
 410-235 ..... 639  
 410-236 ..... 639  
 410-237 ..... 639  
 410-238 ..... 639  
 410-265 ..... 642  
 410-275 ..... 643  
 410-276 ..... 643  
 410-280 ..... 643  
 410-281 ..... 643  
 410-282 ..... 643  
 410-283 ..... 643  
 410-284 ..... 643  
 410-286 ..... 643  
 410-288 ..... 643  
 410-290 ..... 643  
 410-291 ..... 643  
 410-292 ..... 643  
 410-293 ..... 643  
 410-295 ..... 643  
 410-296 ..... 644  
 410-297 ..... 644  
 410-298 ..... 644  
 410-300 ..... 644  
 410-301 ..... 644  
 410-302 ..... 644  
 410-305 ..... 644  
 410-306 ..... 644  
 410-307 ..... 644  
 410-308 ..... 644  
 410-310 ..... 644  
 410-312 ..... 645  
 410-313 ..... 645  
 410-314 ..... 645  
 410-316 ..... 645  
 410-317 ..... 645  
 410-318 ..... 645  
 410-319 ..... 646  
 410-320 ..... 646  
 410-321 ..... 646

410-322 .....	646	420-135.....	691	430-162.....	700
410-323.....	646	420-136 .....	691	430-163.....	700
410-324 .....	646	420-138.....	691	430-164 .....	700
410-325.....	646	420-139 .....	691	430-200 .....	700
410-326 .....	646	420-140 .....	692	430-201.....	700
410-327.....	646	420-141 .....	692	430-202.....	700
410-328.....	646	420-145 .....	692	430-210 .....	700
410-329 .....	646	420-147.....	692	430-211 .....	700
410-330 .....	646	420-148 .....	692	430-212 .....	700
410-332.....	647	420-150.....	693	430-220.....	701
410-333.....	647	420-155.....	693	430-221 .....	701
410-335.....	647	420-160.....	693	430-222.....	701
410-340 .....	647	420-161.....	693	430-225.....	701
410-345 .....	647	420-170 .....	694	430-240.....	701
410-346 .....	647	420-171 .....	694	430-241.....	701
410-347.....	647	420-172.....	694	430-242 .....	701
410-348 .....	647	420-173.....	694	430-245.....	701
410-349 .....	647	420-175.....	695	440-110.....	705
415-100.....	29, 648	420-176.....	695	440-114 .....	705
415-101.....	29, 648	420-177.....	695	440-118 .....	705
415-102 .....	29, 648	420-178.....	695	440-130 .....	705
415-105 .....	29, 648	420-179.....	695	440-134 .....	705
415-110.....	29, 648	420-180.....	695	440-138.....	705
415-112 .....	29, 648	420-181 .....	695	440-140.....	705
415-114 .....	29, 649	420-182.....	695	440-150.....	705
415-115 .....	30, 649	420-184 .....	696	440-154 .....	705
415-116.....	30, 649	420-210 .....	696	440-158 .....	705
415-117 .....	30, 649	430-102 .....	698	440-160.....	706
415-118 .....	30, 650	430-103 .....	698	440-161 .....	706
415-119.....	31, 650	430-104 .....	698	440-162 .....	706
415-120 .....	31, 650	430-105 .....	698	440-163.....	706
415-121.....	31, 650	430-107 .....	698	440-164 .....	706
415-123.....	31, 651	430-108 .....	698	440-165 .....	706
415-124 .....	31, 651	430-109.....	698	440-166 .....	706
415-125.....	32, 651	430-120.....	698	440-167.....	706
415-127.....	32, 651	430-121 .....	698	440-170 .....	707
415-130 .....	32, 652	430-122.....	698	440-174 .....	706
415-133.....	32, 652	430-126 .....	698	440-178.....	706
415-140 .....	33, 652	430-127.....	698	440-182 .....	707
415-141.....	33, 652	430-128.....	698	440-184 .....	706
415-145 .....	33, 652	430-135.....	698	440-186 .....	706
415-150 .....	33, 653	430-136.....	698	440-200.....	707
415-152 .....	33, 653	430-137 .....	698	440-202 .....	707
415-170 .....	33, 653	430-140 .....	699	440-204 .....	707
415-172.....	33, 653	430-145.....	699	440-208 .....	707
420-100.....	689	430-146 .....	699	440-300.....	707
420-101.....	689	430-147.....	699	440-304 .....	707
420-102 .....	689	430-148.....	699	440-306.....	707
420-110.....	689	430-149 .....	699	440-308 .....	708
420-111.....	689	430-150 .....	699	440-310.....	708
420-120 .....	690	430-155.....	699	440-312 .....	708
420-125.....	690	430-156 .....	699	440-314 .....	708
420-126 .....	690	430-157.....	699	440-316 .....	708
420-130 .....	690	430-160.....	700	440-318 .....	708
420-132.....	691	430-161 .....	700	440-340 .....	709



440-342.....	709	450-124.....	715	450-527.....	723
440-344.....	709	450-125.....	715	450-528.....	723
440-346.....	709	450-126.....	715	450-529.....	723
440-348.....	709	450-127.....	715	460-100.....	725
440-350.....	709	450-128.....	715	460-101.....	725
440-360.....	710	450-140.....	716	460-102.....	725
440-364.....	710	450-141.....	716	460-103.....	725
440-368.....	710	450-142.....	716	460-104.....	725
440-370.....	710	450-143.....	716	460-105.....	725
440-372.....	710	450-144.....	716	460-106.....	725
440-376.....	710	450-145.....	716	460-107.....	725
440-378.....	710	450-146.....	716	460-108.....	725
440-380.....	710	450-147.....	716	460-109.....	725
440-390.....	711	450-148.....	716	460-130.....	725
440-394.....	711	450-149.....	716	460-230.....	726
440-398.....	711	450-150.....	717	460-231.....	726
440-400.....	711	450-151.....	717	460-232.....	726
440-402.....	711	450-155.....	717	460-235.....	726
440-404.....	711	450-160.....	717	460-236.....	726
440-406.....	711	450-161.....	717	460-237.....	726
440-407.....	711	450-162.....	717	460-240.....	726
440-408.....	711	450-163.....	717	460-245.....	727
440-410.....	711	450-164.....	717	460-246.....	727
440-412.....	711	450-165.....	717	460-247.....	727
440-416.....	711	450-166.....	717	460-248.....	727
440-420.....	711	450-167.....	717	460-249.....	727
440-430.....	712	450-200.....	718	460-400.....	727
440-510.....	712, 822	450-201.....	718	460-401.....	727
440-530.....	711	450-205.....	718	460-405.....	727
440-532.....	706, 707, 708, 710	450-210.....	718	460-420.....	728
440-700.....	712	450-220.....	718	460-425.....	728
440-720.....	712	450-222.....	718	460-430.....	728
440-730.....	712	450-300.....	719	460-433.....	728
440-740.....	712	450-301.....	719	460-435.....	728
440-770.....	712	450-310.....	480, 719	460-440.....	729
449-310.....	480, 719	450-311.....	719	460-600.....	729
450-090.....	642, 714	450-399.....	719	460-601.....	729
450-091.....	642, 714	450-400.....	719	460-602.....	729
450-092.....	642, 714	450-401.....	719	460-603.....	729
450-093.....	642, 714	450-407.....	720	460-604.....	729
450-100.....	714	450-412.....	720	460-605.....	729
450-101.....	714	450-415.....	720	460-606.....	729
450-102.....	714	450-417.....	720	460-607.....	729
450-103.....	714	450-420.....	720	460-608.....	729
450-105.....	714	450-450.....	34, 721	460-609.....	729
450-106.....	714	450-455.....	34, 721	460-610.....	729
450-110.....	715	450-457.....	34, 721	460-611.....	729
450-111.....	715	450-460.....	34, 721	460-620.....	730
450-112.....	715	450-500.....	723	460-621.....	730
450-113.....	715	450-501.....	723	460-622.....	730
450-120.....	715	450-505.....	723	460-623.....	730
450-121.....	715	450-510.....	723	460-624.....	730
450-122.....	715	450-524.....	723	460-625.....	730
450-123.....	715	450-525.....	723	460-626.....	730
		450-526.....	723	460-627.....	730

460-628 .....	730	475-310.....	752	475-557 .....	760
460-629 .....	730	475-320 .....	752	475-558 .....	760
460-630 .....	730	475-330 .....	753	475-559 .....	760
460-631 .....	730	475-331 .....	753	475-560.....	760
460-640.....	730	475-333.....	753	475-561.....	760
460-641.....	730	475-335.....	753	475-562.....	760
460-642.....	730	475-337.....	753	475-563.....	760
460-643.....	730	475-340.....	753	475-564.....	760
460-644.....	730	475-342.....	753	475-634.....	760
460-645.....	730	475-415.....	755	475-635.....	760
460-646.....	730	475-416.....	755	475-636.....	760
460-647.....	730	475-425.....	756	475-637.....	760
460-648.....	730	475-426.....	756	500-100.....	762
460-649.....	730	475-427.....	756	500-105.....	762
460-650.....	730	475-428.....	756	500-110.....	762
460-651.....	730	475-429.....	167, 764	500-115.....	762
475-100.....	746	475-440.....	756	500-120.....	762
475-105.....	746	475-470.....	757	500-125.....	762
475-110.....	746	475-471.....	757	500-130.....	762
475-120.....	746	475-472.....	757	500-135.....	762
475-125.....	747	475-473.....	757	500-137.....	763
475-127.....	747	475-480.....	757	500-138.....	763
475-130.....	747	475-485.....	757	500-139.....	763
475-140.....	747	475-490.....	757	500-141.....	763
475-142.....	747	475-491.....	757	500-142.....	763
475-150.....	748	475-492.....	757	500-143.....	763
475-152.....	748	475-493.....	757	500-145.....	763
475-155.....	748	475-494.....	757	500-146.....	763
475-160.....	748	475-500.....	453, 758	500-147.....	763
475-162.....	748	475-505.....	454, 758	500-148.....	763
475-165.....	748	475-510.....	454, 759	500-160.....	764
475-175.....	748	475-520.....	454, 759	500-162.....	764
475-176.....	748	475-525.....	454, 759	500-163.....	764
475-177.....	748	475-535.....	760	500-164.....	764
475-180.....	749	475-536.....	760	500-166.....	764
475-181.....	749	475-537.....	760	500-167.....	764
475-182.....	749	475-538.....	760	500-168.....	764
475-185.....	749	475-539.....	760	500-170.....	765
475-186.....	749	475-540.....	760	500-171.....	765
475-187.....	749	475-541.....	760	500-172.....	765
475-212.....	749	475-542.....	760	500-173.....	765
475-214.....	749	475-543.....	760	500-174.....	765
475-222.....	749	475-544.....	760	500-175.....	765
475-224.....	749	475-545.....	760	500-180.....	765
475-232.....	750	475-546.....	760	500-181.....	765
475-234.....	750	475-547.....	760	500-182.....	765
475-242.....	750	475-548.....	760	500-184.....	766
475-244.....	750	475-549.....	760	500-185.....	766
475-252.....	750	475-550.....	760	500-186.....	766
475-254.....	750	475-551.....	760	500-190.....	766
475-262.....	750	475-552.....	760	500-191.....	766
475-264.....	750	475-553.....	760	500-192.....	766
475-305.....	751	475-554.....	760	500-195.....	766
475-306.....	751	475-555.....	760	500-197.....	766
475-307.....	751	475-556.....	760	500-200.....	767



500-201.....	767	500-337.....	771	505-144.....	774
500-202.....	767	500-340.....	772	505-145.....	774
500-203.....	767	500-400.....	767	505-146.....	774
500-204.....	767	500-401.....	767	505-150.....	774
500-205.....	767	500-402.....	767	505-160.....	775
500-206.....	767	500-403.....	767	505-162.....	775
500-207.....	767	500-404.....	767	505-163.....	775
500-208.....	767	500-405.....	767	505-170.....	775
500-209.....	767	500-406.....	767	505-175.....	775
500-215.....	767	500-407.....	767	505-200.....	776
500-230.....	768	500-408.....	767	505-205.....	776
500-232.....	768	500-409.....	767	505-206.....	776
500-233.....	768	500-410.....	767	505-210.....	776
500-234.....	768	500-411.....	767	505-215.....	776
500-235.....	768	500-412.....	767	505-220.....	777
500-236.....	768	500-413.....	767	505-225.....	777
500-237.....	768	500-414.....	767	505-230.....	777
500-240.....	768	500-415.....	767	505-231.....	777
500-241.....	768	500-416.....	767	505-232.....	777
500-242.....	768	500-417.....	767	505-240.....	778
500-243.....	768	500-418.....	767	505-241.....	778
500-244.....	768	500-419.....	767	505-245.....	778
500-245.....	768	500-420.....	767	505-246.....	778
500-246.....	768	500-421.....	767	505-250.....	778
500-247.....	768	500-422.....	767	505-252.....	778
500-248.....	768	500-423.....	767	505-255.....	778
500-250.....	768	500-424.....	767	505-260.....	779
500-252.....	768	500-425.....	767	505-261.....	779
500-256.....	769	500-426.....	767	505-262.....	779
500-258.....	769	500-427.....	767	505-263.....	779
500-265.....	769	500-428.....	767	505-264.....	779
500-270.....	769	500-429.....	767	505-265.....	40, 779
500-295.....	770	500-430.....	767	505-266.....	40, 779
500-298.....	770	500-431.....	767	505-267.....	40, 779
500-299.....	770	500-432.....	767	505-268.....	40, 779
500-300.....	770	500-433.....	767	505-269.....	40, 779
500-301.....	770	500-434.....	767	505-270.....	40, 779
500-302.....	770	500-435.....	767	505-271.....	40, 779
500-303.....	770	500-436.....	767	505-272.....	40, 779
500-304.....	770	500-437.....	767	505-273.....	40, 779
500-305.....	770	500-438.....	767	505-280.....	780
500-306.....	770	500-439.....	767	505-281.....	780
500-310.....	770	500-440.....	767	505-282.....	780
500-311.....	770	500-441.....	767	505-283.....	780
500-312.....	770	500-442.....	767	505-284.....	780
500-313.....	770	500-443.....	767	505-285.....	780
500-314.....	770	505-100.....	772	505-286.....	780
500-315.....	770	505-105.....	772	505-287.....	780
500-316.....	770	505-110.....	772	505-288.....	780
500-320.....	771	505-115.....	772	505-289.....	780
500-325.....	771	505-116.....	773	505-290.....	780
500-330.....	771	505-120.....	773	505-291.....	780
500-331.....	771	505-125.....	773	505-292.....	780
500-335.....	771	505-135.....	773	505-293.....	780
500-336.....	771	505-140.....	774	505-294.....	780

505-295.....	780
505-300.....	780
505-305.....	780
505-310.....	780
505-312.....	781
505-313.....	781
505-314.....	781
505-315.....	781
505-316.....	781
505-317.....	781
505-318.....	781
505-319.....	781
505-320.....	781
505-321.....	782
505-322.....	782
505-325.....	782
505-326.....	782
505-327.....	783
505-328.....	783
505-330.....	781
505-335.....	783
505-340.....	783
505-345.....	783
505-360.....	784
505-365.....	784
505-400.....	35, 787
505-401.....	35, 787
505-402.....	35, 787
505-405.....	35, 787
505-406.....	35, 787
505-407.....	35, 787
505-435.....	35, 788
505-436.....	35, 788
510-100.....	789
510-120.....	789
510-130.....	789
510-140.....	789
510-145.....	790
510-155.....	790
510-165.....	790
510-200.....	790
510-205.....	790
510-220.....	790
510-225.....	791
510-235.....	791
510-245.....	791
510-260.....	791
510-265.....	791
510-275.....	792
510-290.....	792
510-300.....	792
510-330.....	792
600-618.....	821
600-620.....	821
730-100.....	802
730-100B.....	803
730-101.....	802
730-101B.....	803
730-102.....	802
730-102B.....	803
730-103.....	802
730-103B.....	803
730-110.....	802
730-110B.....	803
730-111.....	802
730-111B.....	803
730-112.....	802
730-112B.....	803
730-113.....	802
730-113B.....	803
730-120.....	802, 804,
.....	809
730-121.....	802
730-122.....	802
730-123.....	802
730-124.....	802
730-125.....	802
730-200.....	804
730-200B.....	805
730-201.....	804
730-201B.....	805
730-202.....	804
730-202B.....	805
730-210.....	804
730-210B.....	805
730-211.....	804
730-211B.....	805
730-212.....	804
730-212B.....	805
730-220.....	804, 806,
.....	809
730-221.....	804
730-222.....	804
730-223.....	804
730-224.....	804
730-225.....	804
730-300.....	806
730-300B.....	807
730-301.....	806
730-301B.....	807
730-302.....	806
730-302B.....	807
730-303.....	806
730-303B.....	807
730-310.....	806
730-310B.....	807
730-311.....	806
730-311B.....	807
730-312.....	806
730-312B.....	807
730-313.....	806
730-313B.....	807
730-320.....	806, 808,
.....	809
730-321.....	806
730-322.....	806
730-323.....	806
730-324.....	806
730-325.....	806
740-100.....	803
740-101.....	803
740-102.....	803
740-200.....	805
740-201.....	805
740-202.....	805
740-300.....	807
740-301.....	807
740-302.....	807
750-100.....	803
750-101.....	803
750-102.....	803
750-200.....	805
750-201.....	805
750-202.....	805
750-300.....	807
750-301.....	807
750-302.....	807
760-400.....	822
760-405.....	822
760-410.....	822
760-415.....	822
760-420.....	822
760-425.....	822
760-430.....	822
760-435.....	822
760-440.....	822
760-445.....	822
760-450.....	822
760-455.....	822
760-460.....	822
760-465.....	822
760-470.....	822
760-475.....	822
760-480.....	822
760-485.....	822
760-490.....	822
760-495.....	822
775-100.....	810
775-101.....	810
775-102.....	810
775-103.....	810
775-104.....	810
775-105.....	810
775-120.....	810
775-121.....	810



775-122 .....	810	835-541 .....	737	840-215 .....	250
775-123 .....	810	835-542 .....	737	840-220 .....	250
775-124 .....	810	835-543 .....	737	840-225 .....	250
775-125 .....	810	835-545 .....	737	840-230 .....	251
775-130 .....	810	835-546 .....	737	840-300 .....	251
775-131 .....	810	835-550 .....	738	840-305 .....	251
775-132 .....	810	835-551 .....	738	840-310 .....	251
775-133 .....	810	835-552 .....	738	840-315 .....	251
775-134 .....	810	835-555 .....	738	840-320 .....	252
775-135 .....	810	835-560 .....	738	840-325 .....	252
775-200 .....	809	835-561 .....	738	840-330 .....	252
775-300 .....	809	836-100 .....	739	840-335 .....	252
775-400 .....	809	836-105 .....	740	840-340 .....	252
790-010 .....	808, 818	836-110 .....	740	840-345 .....	253
835-100 .....	732	836-115 .....	741	840-350 .....	253
835-105 .....	732	836-120 .....	740	840-355 .....	253
835-110 .....	732	836-125 .....	740	840-360 .....	253
835-115 .....	732	836-130 .....	741	840-365 .....	253
835-120 .....	732	836-135 .....	741	840-370 .....	253
835-125 .....	732	836-140 .....	741	841-110 .....	253
835-130 .....	733	836-145 .....	739	842-100 .....	253
835-135 .....	733	836-146 .....	739	842-105 .....	253
835-140 .....	733	836-150 .....	741	842-110 .....	253
835-145 .....	733	836-155 .....	739	842-500 .....	254
835-150 .....	733	836-160 .....	739	842-505 .....	254
835-155 .....	733	836-165 .....	739	842-600 .....	254
835-160 .....	733	836-170 .....	739	842-605 .....	254
835-165 .....	733	836-175 .....	740	842-610 .....	254
835-170 .....	734	836-180 .....	740	842-615 .....	254
835-175 .....	734	836-185 .....	741	842-620 .....	254
835-180 .....	734	836-190 .....	742		
835-185 .....	734	836-195 .....	741		
835-190 .....	734	836-200 .....	741		
835-195 .....	734	836-205 .....	740		
835-200 .....	735	836-210 .....	740		
835-205 .....	735	837-100 .....	743		
835-210 .....	735	837-105 .....	743		
835-215 .....	735	837-110 .....	743		
835-220 .....	735	837-115 .....	743		
835-235 .....	735	837-120 .....	743		
835-240 .....	735	838-200 .....	743		
835-300 .....	735	838-210 .....	744		
835-305 .....	736	838-215 .....	744		
835-310 .....	736	838-220 .....	744		
835-400 .....	736	838-250 .....	744		
835-405 .....	736	838-270 .....	744		
835-410 .....	736	838-500 .....	744		
835-500 .....	736	840-100 .....	250		
835-505 .....	737	840-110 .....	250		
835-510 .....	736	840-120 .....	250		
835-515 .....	736	840-130 .....	250		
835-520 .....	737	840-140 .....	250		
835-525 .....	737	840-200 .....	250		
835-530 .....	737	840-205 .....	250		
835-540 .....	737	840-210 .....	250		



**Integra™**  
Alphabetical  
Index

300X Band Pusher ..... 744

**Abdominal**

Retractor ..... 169, 185-191

Scissors ..... 6-7, 788

Adair Breast Clamp ..... 131

**Adapters**

Vascular ..... 423

Adenoid Curette ..... 699-700

Adenoid Punch ..... 700-701

Adson Bipolar Forceps ..... 121, 313

Adson Cannula, Open End ..... 327

Adson Cerebellar Retractor ..... 182, 331

Adson Dressing Forceps ..... 104-105, 117,

..... 304-305, 309,

..... 683-684

Adson Drill Guide ..... 343

Adson Dura Hook ..... 316, 368

Adson Ganglion Scissors ..... 15, 344

Adson Hemostatic Forceps ..... 302, 479

Adson Hypophyseal Forceps ..... 117, 310

Adson Needle Pulling Forceps ..... 95, 688

Adson Periosteal Elevator ..... 318

Adson Rongeur ..... 215

Adson Suction Tube ..... 327

Adson Tissue Forceps ..... 104-105,

..... 304-305,

..... 683-684

Agricola Lacrimal Sac Retractor ..... 511

Air Injection Cannula ..... 562

Alderdyce Elevator and Dissector ..... 320

Alderkreutz Tissue Forceps ..... 109

Alexander Periosteotome ..... 367

Alfonso Eye Speculum ..... 509

Allen Intestinal Clamp ..... 133

**Alligators**

Cup Forceps ..... 587

Forceps ..... 567-568,

..... 587-588

Allis Atraumatic Tissue Forceps ..... 127

Allis Tissue Forceps ..... 54, 126-127

Allis-Adair Tissue Forceps ..... 128

Allison Lung Retractor ..... 346

Allis-Willauer Tissue Forceps ..... 402, 797

Allport Incus Hook ..... 572

Alm Retractor ..... 178, 639

Aluminum Hand Immobilizer, 4/Box ..... 211

Amalgam Carrier ..... 743

Anastomosis Clamp ..... 473

Anastomosis Partial Occlusion Clamp ..... 469

Anderson-Adson Retractor ..... 329

Anderson-Neivert Osteotome ..... 643

Andrew Mastoid Chisel ..... 574

Andrew Mastoid Gouge ..... 574

Andrew Tongue Depressor ..... 717

Andrews-Pynchon Suction Tube ..... 148, 724

Anis Needle Holder ..... 548

Ankeney Sternal Retractor ..... 355

**Anoscopes**

Rectal ..... 748

Anthony Suction Tube ..... 585

**Antrum**

Cannula ..... 608

Curette ..... 617, 704, 711

Needle ..... 607

Trocar ..... 607

Apical Dental Elevator ..... 736

**Applicators**

Cotton ..... 592

**Approximators**

Sternal ..... 359

Arruga Capsule Forceps ..... 545

**Artery**

Clamp ..... 145, 302, 403,

..... 404, 457, 796

Forceps ..... 51, 57-62, 64,

..... 404-406, 410,

..... 678, 681,

..... 785-786, 795,

..... 797-798

Scissors ..... 20, 49, 380

Asch Septum Forceps ..... 623

Aspirating Syringe ..... 744

Aufranc Cobra Retractor ..... 209

Aufricht Nasal Retractor ..... 635

Aufricht Nasal Scissors ..... 32, 651

Aufricht Rasp ..... 692

Auvard Vaginal Specula ..... 763

Babcock Tissue Forceps ..... 54, 130, 796

Baby Doyen Intestinal Clamp ..... 133

Backhaus Towel Forceps ..... 65

Badgley Retractor ..... 338

Bahnon Aortic Clamp ..... 436

Bailey Aortic Valve Rongeur ..... 428

Bailey Forceps ..... 457, 477

Bailey Gigli Saw Guide ..... 244

Bailey Rib Contractor ..... 359

Bailey-Finochietto Rib Spreader ..... 351, 499

Bailey-Gibbon Rib Contractor ..... 359

Bainbridge Forceps ..... 63-64, 403, 447,

..... 456, 478

Bakes Common Duct Dilator ..... 141

Balfour Abdominal Retractor ..... 185-191

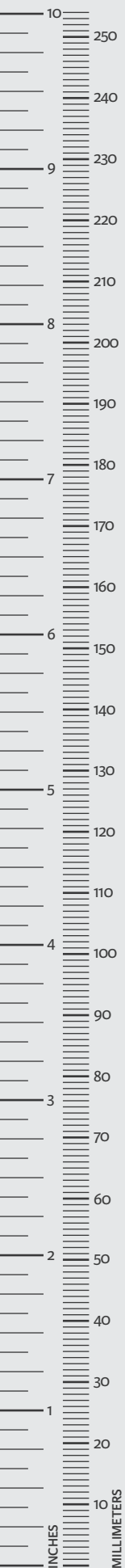

Balfour Center Blade ..... 187, 190  
 Balfour Fourth Blade Attachment..... 191  
 Balfour Wire Lateral Blade ..... 186, 189  
 Ball Nerve Hook ..... 429  
 Ballenger Septum Elevator ..... 612  
 Ballenger Swivel Knife..... 610  
 Ballenger Tonsil Seizing Forceps ..... 718  
 Ballenger V-Shaped Chisel ..... 609  
 Bane Rongeur ..... 214, 577  
 Bariatric Instrument Case..... 821

**Bariatrics**

Clamp ..... 796  
 Forceps ..... 795-798  
 Needle Holders ..... 799  
 Scissors ..... 794  
 Suction Tubes ..... 800  
 Retractors ..... 800  
 Barnhill Adenoid Curette ..... 699  
 Baron Suction Tube ..... 327, 586  
 Barr Anal Retractor ..... 746  
 Barr Fistula Probe..... 753  
 Barraquer Blade Breaker ..... 513  
 Barraquer Cilia Forceps ..... 541  
 Barraquer Cyclodialysis Spatula ..... 522  
 Barraquer Eye Speculua ..... 508  
 Barraquer Iris Spatula..... 520, 522  
 Barraquer Needle Holder..... 547  
 Barraquer-Dewecker Iris Scissors ..... 558  
 Barrett Placenta Forceps ..... 790  
 Barrett Tenaculum Forceps..... 776  
 Barron Knife Handle ..... 72  
 Baumgarten Needle Holder ..... 77, 82, 670,  
 ..... 672-673  
 Bayonet Needle Holder..... 80, 671  
 Beall-Morris Aorta Clamp..... 437  
 Beasley-Babcock Tissue Forceps ..... 107, 685  
 Bechert Nucleus Rotator ..... 522  
 Beck Aorta Clamp ..... 441  
 Beck Miniature Aorta Clamp ..... 471  
 Beck Vessel Clamp ..... 467  
 Becker Septum Scissors..... 32, 652  
 Beckman Nasal Speculum..... 600  
 Beckman Thyroid Retractor ..... 182, 332  
 Beckman-Adson Retractor ..... 183, 332  
 Beckman-Eaton Retractor ..... 183, 332  
 Bell Pattern Bone File ..... 736  
 Bellucci Alligator Scissors..... 588  
 Bellucci Cannula only..... 585  
 Bellucci Micro Ear Scissors..... 568  
 Bellucci Suction Tube..... 585  
 Bellucci Tip Only ..... 585  
 Bellucci-Wullstein Retractor ..... 591  
 Bengolea Forceps..... 406

Bennett Tibia Retractors ..... 207  
 Benson Pylorus Spreader..... 131  
 Berke Ptosis Clamp..... 545  
 Berry Sternal Needle Holder ..... 93, 420  
 Bethune Rib Shears ..... 362  
 Bethune-Coryllos Rib Shears ..... 363  
 Beyer Rongeur ..... 216, 579  
 Bill Traction Handle ..... 792  
 Billeau Ear Loop ..... 571  
 Billroth Tumor Forceps ..... 784

**Biopsy**

Forceps ..... 749-750,  
 ..... 772-774  
 Needle ..... 151

**Bipolar**

Forceps ..... 121-124, 311-314  
 Cord ..... 124, 312, 314  
 Bipolar Forceps (Reusable) ..... 311-312  
 Bipolar Forceps (Disposable)..... 124, 313-314  
 Bishop-Harmon Iris Forceps ..... 527

**Blade**

Breaker ..... 513  
 Remover ..... 69

**Blades**

Balfour Retractor ..... 186-187, 189-190  
 Center ..... 187, 190  
 Cloward Cervical..... 339  
 Hibbs ..... 337  
 Laminectomy ..... 338  
 Meyerding ..... 337  
 Mouth Gag ..... 642, 714-715,  
 ..... 717  
 Neuro/Spine ..... 336-339  
 Scoville..... 336-337  
 Taylor ..... 338  
 Tongue ..... 642, 714-715,  
 ..... 717  
 Wire Lateral ..... 186, 189  
 Wire Saw ..... 244  
 Urethrotome ..... 755  
 Blair Palate Hook..... 632  
 Blake Gall Stone Forceps..... 142  
 Blakesley Forceps..... 705  
 Blakesley Septum Forceps ..... 621  
 Blakesley Suction Forceps ..... 706-707  
 Blakesley Thru-Cutting Forceps ..... 706  
 Blount Knee Retractor..... 207  
 Blount Retractor ..... 207  
 Blumenthal Rongeur ..... 212, 576  
 Bodenhammer Rectal Speculum ..... 746

Boettcher Tonsil Scissors..... 34, 721  
 Boies Nasal Fracture Elevator..... 613  
 Bonaccolto Utility Forceps ..... 536

**Bone**

Awl..... 235  
 Caliper..... 262  
 Chisel ..... 229, 235, 254,  
 ..... 736  
 Clamp..... 202, 204-206  
 Curette ..... 224-225, 735  
 Elevator ..... 240  
 File ..... 245, 736  
 Forceps..... 205-206,  
 ..... 220-221, 364,  
 ..... 458, 566  
 Gouge..... 230-231, 235,  
 ..... 250  
 Hook..... 225  
 Mallet ..... 238-239  
 Osteotome ..... 229-230,  
 ..... 234-237  
 Racks ..... 228, 817  
 Raspatory..... 243, 245  
 Reduction Forceps..... 202-203  
 Retractor ..... 208-209,  
 ..... 211, 245  
 Rongeur ..... 212-219, 221,  
 ..... 364-366,  
 ..... 576-579  
 Saw ..... 244  
 Skid..... 208  
 Splitting Forceps..... 625  
 Tamp..... 239

Bonn Iris Forceps ..... 530  
 Bonn Iris Hook ..... 516  
 Bonn Suture Forceps ..... 530  
 Bonney Needle Pulling Forceps..... 95, 393  
 Bonney Tissue Forceps..... 109, 687  
 Botvin Iris Forceps ..... 527  
 Boucheron Ear Specula..... 564  
 Bowman Lacrimal Probe..... 560  
 Boyd Tonsil Scissors ..... 34, 721  
 Boyes-Goodfellow Hook ..... 225  
 Boys-Allis Tissue Forceps..... 128  
 Bozeman Uterine Dressing Forceps ..... 775  
 Bracken Fixation Forceps..... 529  
 Brain Dressing and Tissue Forceps..... 116, 306  
 Brand Tendon Pulling Forceps ..... 249  
 Braun Episiotomy Scissors ..... 35, 788  
 Braun Tenaculum Forceps ..... 776  
 Bridge Forceps..... 405  
 Brigham Tissue Forceps ..... 108  
 Brinkerhoff Rectal Specula..... 748  
 Broli-Adson Forceps ..... 106, 264, 305,

..... 385  
 Brophy Gum and Suture Scissors ..... 33, 652  
 Brown Applicator..... 582  
 Brown Dissecting Scissors ..... 33, 653  
 Brown Needle Holder ..... 76, 669  
 Brown Tissue Forceps ..... 106-107, 385,  
 ..... 685  
 Brown-Adson Needle Pulling Forceps .... 95, 688  
 Brown-Adson Tissue Forceps..... 107, 685  
 Bruening Nasal Snare..... 606  
 Bruening Septum Forceps ..... 622  
 Bruns Bone Curette ..... 222-224  
 Bruns Curette Rack..... 227, 816  
 Bruns Plaster Shears..... 200  
 Buck Applicator..... 582  
 Buck Ear Curettes ..... 570  
 Buck Myringotomy Knife..... 574  
 Buck Neurological Hammer..... 151  
 Buie Fistula Probe ..... 753  
 Buie Pile Clamp ..... 752  
 Buie Rectal Suction Tube..... 752

**Bulldog**

Clamp..... 482-486  
 Bulldog Clamp Applying Forceps ..... 427  
 Bunge Evisceration Spoon ..... 524  
 Bunnell Hand Drill ..... 255  
 Bunnell Tendon Passer..... 249  
 Bunt Forceps Holder..... 814  
 Burch Fixation Pick..... 520  
 Burford Rib Spreader ..... 353-354  
 Burford-Finochietto Rib Spreader ..... 354  
 Burke Cervical Biopsy Punch..... 774  
 Burnisher, Double Ended..... 733

**Burrs**

Enlarging..... 343

**Cables** ..... See Cords

**Calipers**

Eye ..... 558-559  
 Femur ..... 262  
 Marking ..... 559  
 Calman Carotid Closure Clamp ..... 470  
 Campbell Nerve Retractor..... 325

**Cannulas**

Acorn..... 777  
 Antrum..... 608  
 Closed end..... 327  
 Eye ..... 561  
 Heparin ..... 423  
 Injection..... 562  
 Sinus..... 607

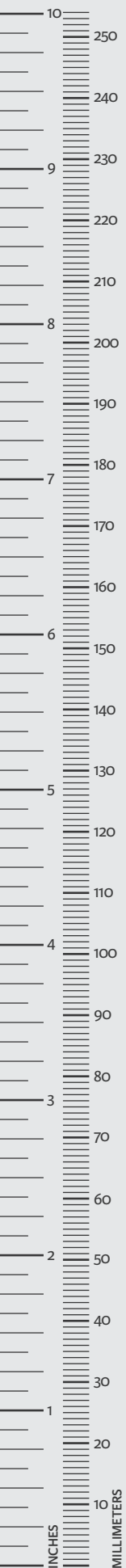

- Suction..... 711  
Trocar and Cannula ..... 712  
Cannulated Pin Cutter ..... 259  
Caplan Nasal Bone Scissors ..... 30, 650  
Capsule Fragment and Clot Forceps ..... 545
- Carb-Bite**  
Needle Holders..... 52-53, 81-93,  
..... 256, 413-420,  
..... 547, 672-675,  
..... 677, 799  
Pulling Forceps..... 94-96,  
..... 393-395, 688  
Rasp..... 694-695
- Carb-Edge**  
Scissors ..... 36-40, 52, 344,  
..... 369, 371,  
..... 373-374, 550,  
..... 552, 661-663,  
..... 722, 772, 779,  
..... 788, 794
- Cardio-Grip**  
Bulldog Clamps..... 482-486  
Intestinal Clamps..... 137-138  
Hysterectomy Forceps ..... 782-783  
Tissue Forceps..... 104-105, 309,  
..... 387, 392,  
..... 396-397,  
Vascular Clamps..... 434-486  
Carmalt Forceps..... 409  
Carmalt Splinter Forceps ..... 125  
Carotid Clamp ..... 469  
Carroll Small Bone Holding Clamp ..... 248  
Carroll Tendon Retriever..... 248
- Cartilage**  
Clamp ..... 246-248  
Crusher ..... 626  
Goniometer ..... 249  
Scissors ..... 14, 246
- Cases** ..... Also See Trays  
Coronary Bypass ..... 819  
Dilator ..... 425-426,  
..... 819-820  
Eye ..... 562, 820  
Instrument..... 821  
Vein Stripper..... 819  
Castanares Face Lift Scissors ..... 44, 665  
Castaneda Anastomosis Clamp ..... 474  
Castaneda Multi-Purpose Clamp ..... 459  
Castaneda Partial Occlusion Clamp..... 475  
Castaneda Sternal Retractor ..... 358
- Castaneda Suture Tag Forceps..... 479
- Castroviejo**  
Blade Breaker ..... 513  
Caliper ..... 558-559  
Corneal Scissors ..... 556-557  
Corneo-Scleral Suture Forceps ..... 531  
Dilator ..... 561  
Colibri Forceps ..... 531  
Cyclodialysis Spatula..... 521  
Fixation Forceps..... 532  
Forceps..... 531-532, 536  
Iris Scissors..... 556  
Lacrimal Dilator ..... 561  
Marking Caliper ..... 559  
Micro Stardust Needle Holder..... 281  
Needle Holder..... 92, 270, 281,  
..... 419, 546-547,  
..... 676-677  
Scissors ..... 556-557  
Spatula ..... 521  
Specula ..... 510  
Suture Tying Forceps..... 532, 536  
Synechia Spatula ..... 522
- Catheter**  
Female ..... 760  
Forceps..... 150  
Guide (Wire Mandrin) ..... 149  
Cement Spatula ..... 734
- Cervical**  
Retractor ..... 339  
Rongeur ..... 290-291  
Spreader..... 334, 340  
Chandler Elevator ..... 240  
Chandler Iris Forceps..... 537  
Cheek Retractor ..... 716  
Chelsea-Eaton Anal Specula ..... 747  
Cherry Supreceliac Clamp ..... 435  
Children's Hospital Retractor ..... 173  
Children's Hospital Spatula ..... 328
- Chisels**  
Bone ..... 229-230, 235,  
..... 254  
Dental..... 736  
Footplate..... 594  
Lacrimal Sac ..... 609  
Mastoid ..... 574  
Plastic Surgery ..... 610, 643-644  
V-Shaped ..... 609  
Church Vascular Scissors..... 18, 377  
Cicherelli Rongeur ..... 215, 578  
Cinelli Lower Lateral Scissors ..... 29, 648

Cinelli Osteotome ..... 644  
 Citelli Rongeur ..... 575

**Clamps**

Anastomosis ..... 133, 473-474  
 Aortic Aneurysm ..... 434-439, 441,  
 ..... 444, 471  
 Appendage ..... 442  
 Artery ..... 145, 302,  
 ..... 403-404, 452,  
 ..... 457, 480, 796  
 Auricle ..... 443, 453  
 AV Fistula ..... 458  
 Bone Holding ..... 202, 204-206,  
 ..... 248  
 Breast ..... 131  
 Bronchus ..... 411, 453  
 Bulldog ..... 448, 482-486  
 Carotid ..... 470  
 Cartilage ..... 246, 248  
 Closure ..... 469-470  
 Coarctation ..... 448-449,  
 ..... 465-466  
 Columella ..... 696  
 Femoral-Popiteal ..... 451  
 Hypogastric ..... 435  
 Hysterectomy ..... 783  
 Iliac ..... 438  
 Internal Carotid ..... 470  
 Intestinal ..... 133-137, 139-140  
 Kidney ..... 454, 759  
 Meniscus ..... 247  
 Microsurgery ..... 270  
 Minature ..... 458  
 Multi-Purpose ..... 444-445, 452,  
 ..... 458-460, 467  
 Muscle ..... 146  
 Neonatal ..... 469  
 Ossicle Holding ..... 599  
 Partial Occlusion ..... 441, 469, 475  
 Patent Ductus ..... 450, 465  
 Pediatric ..... 459, 461-462,  
 ..... 466, 472,  
 ..... 488-491  
 Pedicle ..... 454, 759  
 Penis ..... 790  
 Pile ..... 752  
 Profunda ..... 451, 471  
 Ptosis ..... 545  
 Pylorus ..... 137  
 Right Angle ..... 144, 403, 452  
 Suture ..... 479  
 Tangential Occlusion ..... 440  
 Thoracic ..... 144, 406, 410  
 Vascular ..... 435, 439,

..... 442-447,  
 ..... 467-468,  
 ..... 471-473, 492  
 Vasectomy Ring ..... 757  
 Vena Cava ..... 441-442, 481  
 Vessel ..... 453-454, 467,  
 ..... 758  
 Clayman Iris Hook ..... 518  
 Clayman Lens Forceps ..... 542

**Clip**

Forceps ..... 97  
 Skin ..... 97  
 Snap-On ..... 810  
 Cloward Blade Retractor ..... 334  
 Cloward Cervical Retractor ..... 339  
 Cloward Cervical Spreader ..... 334  
 Cloward Interbody Spreader ..... 341  
 Cloward Lamina Spreader ..... 341  
 Cloward Style Ball Pean Hammer ..... 239  
 Cloward Style Elevator ..... 323  
 Cloward Style Rongeur ..... 296  
 Cloward Vertebra Spreader ..... 340  
 Coakley Antrum Curette ..... 617  
 Coakley Antrum Trocar ..... 607  
 Coakley Curette ..... 704  
 Coakley Sinus Curette ..... 618  
 Cobb Bone Curette ..... 224  
 Cobb Type Instrument Rack ..... 228, 817  
 Cobb-Type Spinal Elevator ..... 233  
 Cobb-Type Spinal Gouge ..... 232  
 Cogswell A "Spade" Elevator ..... 737  
 Cohan Miniature Needle Holder ..... 548  
 Cohen Acorn Cannula ..... 777  
 Collar and Crown Scissors ..... 253  
 College Pliers ..... 101  
 Coller Artery Forceps ..... 64, 404  
 Coller-Crile Forceps ..... 58, 680  
 Collier Needle Holder ..... 77, 670  
 Collins Tissue Forceps ..... 129, 401  
 Collins Tongue Seizing Forceps ..... 150  
 Colver Tonsil Knife ..... 720  
 Colver Tonsil Seizing Forceps ..... 718  
 Comedone Extractor ..... 154  
 Cone Ring Curette ..... 226

**Containers**

Accessories ..... 808-810  
 Full Size ..... 806-808  
 Lid ..... 809  
 One Half Size ..... 802-804  
 Three-Quarter Size ..... 804-806  
 Converse Alar Retractor ..... 635  
 Converse Blade Retractor ..... 639  
 Converse Button End Bistoury ..... 629



- Converse Chisel ..... 644  
 Converse Nasal Retractor ..... 636  
 Converse Needle Holder ..... 76, 669  
 Converse Osteotome ..... 643, 647  
 Converse Periosteal Elevator ..... 614  
 Converse Rasp ..... 690  
 Converse Skin Hook ..... 632  
 Cook Eye Speculum ..... 509  
 Cooley Aorta Clamp ..... 438  
 Cooley Aortic Aneurysm Clamp ..... 434  
 Cooley Bulldog Clamp ..... 483-484  
 Cooley Coarctation Clamp ..... 449, 466  
 Cooley Iliac Clamp ..... 438  
 Cooley Intracardiac Needle Holder ..... 91, 415  
 Cooley Multi-Purpose Clamp ..... 444, 459, 467  
 Cooley Needle Holder ..... 91  
 Cooley Neonatal Vascular Clamp ..... 469  
 Cooley Partial Occlusion Clamp ..... 441  
 Cooley Patent Ductus Clamp ..... 450, 465  
 Cooley Pediatric Clamp ..... 466  
 Cooley Pediatric Multi-Purpose Clamp .. 459  
 Cooley Pediatric Vascular Clamp ..... 472  
 Cooley Peripheral Vascular Clamp ..... 446  
 Cooley Scissors ..... 16, 370  
 Cooley Sternal Retractor ..... 357-358  
 Cooley Suction Tube ..... 421  
 Cooley Tangential Occlusion Clamp ..... 440  
 Cooley Tissue Forceps ..... 103, 397  
 Cooley Valve Retractors ..... 346  
 Cooley Vascular Clamp ..... 472  
 Cooley Vascular Dilator ..... 425  
 Cooley Vena Cava Catheter Clamp ..... 481  
 Cooley-Baumgarten Sternal Wire Twister  
 ..... 93, 256, 420  
 Cooley-Derra Anastomosis Clamp ..... 474  
 Cooley-Satinsky Clamp ..... 471  
 Copper Head Mallet ..... 646
- Cords**  
 Bipolar ..... 124, 312, 314
- Coronary Artery**  
 Bypass Hook ..... 429  
 Bypass Kit ..... 422  
 Forceps ..... 406  
 Nerve Hook ..... 429  
 Scissors ..... 20-21, 49,  
 ..... 379-381  
 Spring Retractor ..... 429  
 Corwin Knife Handle ..... 73  
 Corwin Wire Twister ..... 256  
 Cottle Alar Retractor ..... 635  
 Cottle Biting Forceps ..... 625  
 Cottle Cartilage Crusher ..... 626  
 Cottle Chisel ..... 643  
 Cottle Columella Clamp ..... 696  
 Cottle Dorsal Scissors ..... 30, 46, 649, 668  
 Cottle Elevator ..... 613  
 Cottle Knife ..... 629  
 Cottle Knife Guide and Retractor ..... 633  
 Cottle Mallet ..... 647  
 Cottle Osteotome ..... 647  
 Cottle Rasp ..... 690  
 Cottle Retractor ..... 634  
 Cottle Septum Elevator ..... 613, 704  
 Cottle Septum Scissors ..... 31, 650  
 Cottle Septum Speculum ..... 602, 703  
 Cottle Single Prong Tenaculum ..... 632  
 Cottle Skin Elevator ..... 614  
 Cottle Skin Hook ..... 630  
 Cottle-Joseph Double Hook ..... 631  
 Cottle-Kazanjian Nasal Cutting Forceps 625  
 Cottle-McKenty Elevator ..... 611  
 Coupland Suction Tube ..... 149  
 Covered Instrument Trays ..... 811  
 Crafoord (Coller) Artery Forceps ..... 406  
 Crafoord Coarctation Clamps ..... 449  
 Craig Vertebral Biopsy Set ..... 300  
 Crane Pick Elevator ..... 737  
 Crawford Aortic Retractor ..... 347  
 Crawford-Cooley Graft Tunneler ..... 430  
 Crego Elevator ..... 240  
 Crile Artery Forceps ..... 57  
 Crile Ganglion Knife and Dissector ..... 321  
 Crile Retractor ..... 164  
 Crile-Wood Needle Holder ..... 78, 85, 412-413,  
 ..... 671, 675, 799  
 Cryer Elevator ..... 737  
 Culler Iris Spatula ..... 522
- Cups**  
 Iodine ..... 815  
 Measure ..... 815
- Curettes**  
 Adenoid ..... 698-701  
 Antrum ..... 617, 704, 711  
 Bone ..... 222-225, 251,  
 ..... 735, 816  
 Capsule Polisher ..... 514  
 Chalazion ..... 514  
 Dental ..... 250, 735  
 Dermal ..... 155  
 Disc ..... 225  
 Ear ..... 570-571  
 Elevator ..... 616  
 Endaural ..... 571  
 Endocervical Biopsy ..... 771, 772  
 Endometrial Biopsy ..... 771  
 Ethmoid ..... 617

Middle Ear .....	593, 598
Rhoton-Type.....	277, 501
Ring .....	226
Sinus.....	618
Spinal .....	224
Spinal Fusion.....	223, 226
Uterine.....	770
Uterine Biopsy .....	771
Curette Excavator .....	250
Cusco Vaginal Specula.....	763
Cushing Bipolar Forceps.....	122, 311-313
Cushing Decompression Retractor .....	324
Cushing Dressing Forceps .....	111-112,
.....	306-307, 389,
.....	391
Cushing Dura Hook.....	315
Cushing Elevator.....	320-322, 324
Cushing Gasserian Ganglion Hook .....	316
Cushing Needle Pulling Forceps.....	95, 113, 307,
.....	390, 688
Cushing Perforator Drill.....	343
Cushing Pituitary Rongeur .....	294
Cushing Rongeur.....	215
Cushing Spatula.....	328
Cushing Tissue Forceps .....	112-113,
.....	306-308,
.....	389-391, 495,
.....	504, 687
Cushing Vein Retractor .....	164, 800
Cushing-Brown Tissue Forceps .....	114, 308, 391,
.....	687
Cut Snare Wire .....	723
<b>Cuticle</b>	
Nipper .....	156
Scissors .....	156
<b>Cutters</b>	
Bone .....	220
Nail .....	252
Pin.....	257, 259
Ring .....	154
Wire .....	258
Dale Femoral-Popliteal Clamp .....	451
Dale Thoracic Rongeur .....	219, 366
Dandy Nerve Hook.....	316, 368
Dandy Scalp Forceps .....	301
Dandy Trigeminal Scissors .....	15, 344
Dardik Multi-Purpose Clamp.....	460
Dardik Vascular Tunneler.....	431
Darling Popliteal Retractor .....	195, 349
Davidson Scalpula Retractor.....	346
Davis Mouth Gag.....	715
Davis Retractor.....	159, 639
Davis Spatula.....	328
Day Ear Hook.....	572
Dean Rongeur .....	214, 578
Dean Tonsil Knife.....	720
Dean Tonsil Scissors.....	34, 721
Deaver Pediatric Retractor .....	170
Deaver Retractor .....	171-172, 800
Deaver Scissors.....	4-5
DeBakey Aorta Clamp .....	437
DeBakey Aortic Aneurysm Clamp .....	434
DeBakey Aortic Exclusion Clamp .....	447
DeBakey Bulldog Clamp .....	448, 484
DeBakey Coarctation Clamp .....	448, 465
DeBakey Dilator Case.....	426, 820
DeBakey Dissecting Forceps .....	410
DeBakey Endarterectomy Scissors.....	18, 376
DeBakey Femoral Bypass Tunneler .....	431
DeBakey Forceps.....	495, 498
DeBakey Heparin Cannula.....	423
DeBakey Multi-Purpose Clamp .....	445, 452, 458
DeBakey Needle Holder.....	89, 416
DeBakey Needle Pulling Forceps .....	95, 393-394
DeBakey Patent Ductus Clamp .....	450, 465
DeBakey Peripheral Vascular Clamp .....	446-447, 467
DeBakey Tangential Occlusion Clamp....	440
DeBakey Tissue Forceps.....	102-103,
.....	396-397, 797
DeBakey Vascular Dilator.....	426
DeBakey Vascular Scissors .....	19, 379
DeBakey-Bahnson Clamp.....	444
DeBakey-Bainbridge Clamp .....	64,447, 478
DeBakey-Collier Artery Forceps.....	406, 797
DeBakey-Diethrich Tissue Forceps .....	102, 396
DeBakey-Dietrich Artery Forceps .....	498
DeBakey-Potts Vascular Scissors.....	19, 378
DeBakey-Semb Ligature Carrier .....	411
DeBakey-Vascular Clamp.....	444
Decker Rongeur .....	303
Decker Scissors.....	303
Deep Arteriotomy Spring Retractor .....	429
Deep Perforated Pan.....	812
Deep Rake Retractor.....	210
Delee Obstetrical Forceps .....	790
Delee Universal Retractor.....	766
DeMartel Vascular Scissors .....	17, 375
Demartel-Wolfson Clamp Holder .....	136
Demartel-Wolfson Clamp .....	137
Demartel-Wolfson Closing Forceps .....	136
Demos Tibial Artery Clamp .....	452
Denhardt Mouth Gag.....	744
Dennis Anastomosis Clamp .....	133
Dennis Carotid Clamp.....	470
Dennis Micro Forceps .....	285, 399
Dennis Micro Ring Forceps .....	285, 400, 498
Dennis Micro Scissors.....	265, 382



**Dental**

Amalgam Carrier.....	743
Band Pusher .....	744
Bone File .....	735
Curette .....	251, 735
Elevator .....	737-738
Excavator .....	250, 254
Extraction Forceps.....	739-742
Filling Instrument.....	734
Picks .....	405
Plastic Filling .....	734
Plugger.....	733
Retainer.....	744
Retractor .....	744
Rongeur .....	743
Scissors .....	253
Wax Carver .....	733
Wax Spatula.....	734
Derf Needle Holder.....	76, 82, 669, 672
Derlacki Ossicle Holding Clamp.....	599

**Dermal**

Extractor .....	154
Nipper .....	155-156, 253
Punch .....	155
Scissors .....	156
Splitter .....	156
Derra Anastomosis Clamp.....	474
Derra Partial Occlusion Clamp.....	475
D'Errico Dressing Forceps.....	117, 310
D'Errico Nerve Retractor.....	325
D'Errico Perforator Drill .....	343
Deschamps Ligature Carrier .....	97, 642
Desjardin Gall Stone Forceps .....	142
Desmarres Chalazion Forceps.....	543
Desmarres Lid Retractor .....	511
Desmarres Valve Retractor .....	346

**Diagnostic**

Hammer .....	151
Pin Wheel .....	151
Diamond Pin Cutter.....	257
Diethrich Aorta Clamp.....	438
Diethrich Bulldog Clamp .....	486
Diethrich Circumflex Artery Scissors.....	20, 380
Diethrich Coronary Artery Bypass Kit .....	422
Diethrich Coronary Artery Scissors.....	20, 49, 379-380
Diethrich Coronary Bypass (Case Only)..	819
Diethrich Needle Holder .....	89, 416
Diethrich Right Angle Clamp .....	144, 403
Diethrich-Potts Peripheral Vascular Scissors .....	21, 381
Diffenbach Serrefines Forceps.....	63

**Dilators**

Common Duct .....	141
Lacrimal .....	560-561
Mitral Valve.....	428
Tracheal.....	727
Uterine.....	767-768
Vascular.....	424-426
Dingman Cartilage Clamp.....	247
Dingman Mouth Gag .....	642, 714
Dingman Otoabrader .....	693
Dingman Tongue Blade .....	642, 714
Dingman Wire Passer .....	642
Dingman Zygoma Elevator.....	615

**Dissecting**

Scissors .....	6, 17, 31, 33, 375,
.....	650, 653

**Dissectors**

Elevator .....	615
Endarterectomy .....	428
Intima .....	427
Knife .....	321
Neuro/Spine.....	317-320, 368
Rhoton-Type.....	275, 500
Tonsil Knife.....	720
Dix Foreign Body Spud.....	514
Dorsal Scissors.....	29, 649
Dorsey Dura Separator.....	317
Double Action Wire Cutter.....	258
Douglass Cilia Forceps .....	541
Doyen Abdominal Scissors.....	6
Doyen Intestinal Clamp .....	133-134
Doyen Rasp.....	367
Doyen Retractor.....	165
Doyen Tumor Screw .....	784
Doyen Vaginal Retractor .....	765

**Dressing**

Forceps.....	100, 104-108,
.....	111-112, 116-120,
.....	304-307,
.....	309-310,
.....	388-389,
.....	391, 525,
.....	683-684, 686,
.....	723, 725, 775,
.....	795

**Drills**

Hand.....	255
Neurosurgical.....	342
Perforated .....	343
Duncan Endometrial Biopsy Curette .....	771
Dunning Elevator and Curette .....	616

Duplay Tenaculum Forceps ..... 776  
 Dura Hook ..... 315  
 Duval Lung Forceps ..... 401

**Ear**

Applicator ..... 582  
 Caliper ..... 594  
 Chisel ..... 594, 609  
 Curette ..... 571, 598  
 Elevator ..... 581, 596,  
 ..... 610-611, 615  
 Forceps ..... 119, 537,  
 ..... 566-567,  
 ..... 588-589,  
 ..... 619, 621  
 Gouge ..... 609  
 Hook ..... 572, 592  
 Knife ..... 573, 597-598  
 Loop ..... 571  
 Mirror ..... 592  
 Needle ..... 593  
 Pick ..... 592, 595-596  
 Retractor ..... 159, 591  
 Rongeur ..... 212, 576  
 Snare ..... 570  
 Speculum ..... 565  
 Syringe ..... 583  
 Eastman Vaginal Retractor ..... 764  
 Echlin Rongeur ..... 218, 366  
 Edna Towel Forceps ..... 67  
 Elliott Obstetrical Forceps ..... 791

**Elevators**

Ball End ..... 611, 704  
 Bone ..... 240-241  
 Curette ..... 616  
 Dental ..... 736-737  
 Dissector ..... 615  
 Ear and Nose ..... 580-581,  
 ..... 610-612, 615  
 Hook ..... 632  
 Middle Ear ..... 596  
 Nasal Fracture ..... 613  
 Neuro ..... 320-324, 368,  
 ..... 702  
 Neuro/Spine ..... 320, 322  
 Periosteal ..... 240, 242,  
 ..... 318-319, 580,  
 ..... 613-614  
 Plastic Surgery ..... 613  
 Podiatry ..... 251  
 Rhoton-Type ..... 275, 500  
 Septal ..... 611  
 Septum ..... 612-614, 704  
 Septum Suction ..... 616

Skin ..... 614  
 Spinal ..... 233  
 T-Handle ..... 738  
 Zygoma ..... 615-616  
 Elsberg Cannula, 3-Hole Closed End ..... 327  
 Elsching Fixation Forceps ..... 528  
 Emesis Basin ..... 815  
 Emmett Uterine Tenaculum Hook ..... 779  
 Endarterectomy Scissors ..... 18, 48, 376

**Endural**

Retractor ..... 591  
 Enucleation Scissors ..... 26, 554  
 Eppendorfer Biopsy Forceps ..... 773  
 Epstein Spinal Fusion Curette ..... 226  
 Esmarch Plaster Shears ..... 200  
 Evans Tissue Forceps ..... 110, 388  
 Eve Tonsil Snare ..... 723  
 Ewald (Hudson) Dressing Forceps ..... 106  
 Example Clamp ..... 470

**Excavator**

Dental ..... 250, 254  
 Double Ended ..... 732

**Explorer**

Double Ended ..... 732  
 Single Ended ..... 732

**Extractors**

Comedone ..... 154

**Eye**

Caliper ..... 559  
 Cannula ..... 561  
 Curette ..... 514  
 Dilator ..... 560  
 Forceps ..... 118, 312, 506,  
 ..... 525-530,  
 ..... 533-536,  
 ..... 538-539,  
 ..... 541-542,  
 ..... 544-545  
 Hook ..... 516-517  
 Knife ..... 512  
 Loop ..... 523  
 Needle Holder ..... 546  
 Nucleus Rotator ..... 522  
 Probe ..... 515, 506-561  
 Scissors ..... 22-25, 40, 549,  
 ..... 551-554,  
 ..... 557-558,  
 ..... 656-657, 659,  
 ..... 663  
 Utility Scissors ..... 24, 552, 659



- Spatula ..... 521  
 Speculum..... 508-510  
 Spoon ..... 524  
 Trabeculotome..... 561  
 Eye and Plastic Surgery Case..... 562, 820  
 Fansler (Ives) Rectal Speculum ..... 747  
 Fansler Operating Speculum ..... 747  
 Farabeuf Raspatory..... 243  
 Farabeuf Retractor ..... 162  
 Farabeuf-Lambotte Bone Holding Clamp  
 ..... 204  
 Farr Style Spring Retractor ..... 180  
 Farrell Applicator..... 582  
 Farrior Ear Specula..... 564  
 Faulkner Antrum Curette ..... 617  
 Favaloro Coronary Scissors ..... 21, 49, 381  
 Favaloro-Morse Sternal Retractor ..... 357  
 Fehland Intestinal Clamp..... 135  
 Feilchenfeld Splinter Forceps..... 125  
 Fell Needle Holder ..... 86, 412  
 Female Catheter..... 760  
 Ferguson Abdominal Scissors..... 7, 788  
 Ferguson Angiotribe..... 63  
 Ferguson Gall Stone Scoop ..... 141  
 Ferris-Smith Fragment Forceps..... 623  
 Ferris-Smith Needle Pulling Forceps..... 96, 394  
 Ferris-Smith Rongeur..... 293, 299  
 Ferris-Smith Tissue Forceps ..... 108, 686  
 Fine Tying Forceps ..... 540  
 Finger Goniometer ..... 249  
 Finger Rake Retractor..... 160, 638  
 Finger Ring Cutter ..... 154  
 Finochietto Needle Holder..... 89, 416  
 Finochietto Rib Spreader ..... 350-351  
 Fisher Tonsil Knife..... 720  
 Fixation Hook..... 516  
 Flash Autoclaving Pan ..... 812  
 Flat Nose Plier ..... 261  
 Flat Tip Scissors ..... 9, 375, 654  
 Fletcher Polyp Forceps..... 775  
 Fletcher Sponge Forceps ..... 75  
 Flexible Shaft Retractor ..... 157  
 Flush Wire Cutter..... 258  
 Foerster Sponge Holding Forceps..... 74-75, 795  
 Fomon Chisel ..... 644  
 Fomon Dorsal Scissors..... 30, 46, 649, 668  
 Fomon Lateral Scissors ..... 46, 668  
 Fomon Lower Lateral Scissors ..... 29, 648  
 Fomon Rasp ..... 690-691  
 Fomon Retractor ..... 634  
 Fomon Saber Back Scissors..... 31, 651
- Forceps**
- Alligator Ear..... 567, 587-588  
 Applying..... 97, 135, 427
- Artery ..... 51, 57-62, 64,  
 ..... 404-406, 410,  
 ..... 678, 681,  
 ..... 785-786, 795,  
 ..... 797-798  
 Bead Type ..... 298  
 Biopsy..... 749-750,  
 ..... 772-774  
 Bipolar ..... 121-124, 311-314  
 Biposy..... 773  
 Biting..... 625  
 Bone ..... 205-206,  
 ..... 220-221, 364,  
 ..... 458, 566  
 Bone Cutting ..... 220-221, 364  
 Bone Holding ..... 206  
 Bone Splitting ..... 625  
 Braiding..... 249  
 Capsule ..... 545  
 Cardio-Grip ..... 309, 392  
 Catheter ..... 150  
 Chalazion..... 543-544  
 Cilia..... 541  
 Clip ..... 97  
 Clip Applying..... 97  
 Closing..... 136  
 Colibri..... 531-532  
 Corneal..... 536, 538  
 Corneo-Scleral ..... 531  
 Coronary Tissue ..... 387  
 Crimper ..... 587  
 Cup ..... 726  
 Disc..... 298  
 Discectomy..... 303  
 Dissecting..... 410, 432  
 Dressing ..... 100, 104-108,  
 ..... 111-112, 116-120,  
 ..... 304-307,  
 ..... 309-310,  
 ..... 388-389, 391,  
 ..... 525, 683-684,  
 ..... 686, 723, 725,  
 ..... 775, 795  
 Ear..... 119, 537,  
 ..... 566-567,  
 ..... 588-589,  
 ..... 619, 621  
 Elevating..... 769  
 Entropium..... 544  
 Extraction ..... 739-742  
 Eye ..... 118, 312, 506,  
 ..... 526-530,  
 ..... 533-536,  
 ..... 538-539,  
 ..... 541-542,

..... 544-545  
 Fixation ..... 528-529, 532  
 Foreign Body ..... 537  
 Fragment ..... 545  
 Frontal Sinus ..... 708  
 Gall Duct ..... 142, 407  
 Gall Stone ..... 142  
 Gallbladder ..... 144  
 Grasping ..... 726, 751  
 Hemostatic ..... 55-64, 146, 302,  
 ..... 403, 447,  
 ..... 456-457, 477,  
 ..... 479, 680-681,  
 ..... 754  
 Holder ..... 814  
 Hypophyseal ..... 117, 310  
 Hysterectomy ..... 780-783  
 Intestinal ..... 134, 795  
 Iris ..... 526-527, 530,  
 ..... 537  
 Kidney Stone ..... 757  
 Lens ..... 542  
 Ligamentum Flavum ..... 247  
 Lung ..... 401  
 Micro ..... 265, 285, 382,  
 ..... 399-400, 503  
 Micro Corneal ..... 539  
 Micro Ring ..... 285, 498  
 Microsurgical ..... 116, 264, 267,  
 ..... 270, 398-400,  
 ..... 503, 588-589  
 Middle Ear ..... 587-588  
 Mixer ..... 54, 143,  
 ..... 407-409, 456,  
 ..... 682, 798  
 Mosquito ..... 50-51, 55-56,  
 ..... 301-302, 402,  
 ..... 476, 678-680  
 Muscle Recession ..... 545  
 Nasal ..... 119-120,  
 ..... 603-604,  
 ..... 620-621,  
 ..... 624-625, 705,  
 ..... 707  
 Nasal Cutting ..... 625, 707  
 Nasal Dressing ..... 119-120,  
 ..... 603-604  
 Obstetrical ..... 790-792  
 Occluding ..... 68-69, 481  
 Ochsner ..... 51, 679  
 Pean ..... 51, 132, 679  
 Pediatric ..... 705  
 Petit-Point ..... 50-54  
 Phalangeal ..... 248  
 Placenta ..... 789-790

Plaque ..... 109, 387  
 Polyp ..... 619, 775  
 Pulling ..... 95-96, 113, 249,  
 ..... 252, 256, 307,  
 ..... 390, 393-395,  
 ..... 688  
 Puncturing ..... 789  
 Reduction ..... 202-203  
 Retrieving ..... 248  
 Rhoton-Type ..... 264, 278, 398  
 Ring ..... 503  
 Scalp ..... 301  
 Septum ..... 621-624  
 Serrefines ..... 63  
 Sinus Endoscopy ..... 707  
 Splinter ..... 125  
 Sponge Holding ..... 74-75, 795  
 Spreading ..... 537  
 Stardust ..... 279-286, 493,  
 ..... 496-497,  
 ..... 502-505,  
 Suction ..... 706-708  
 Superior Rectus ..... 545  
 Suture ..... 264, 398, 479,  
 ..... 530-532,  
 ..... 535-537,  
 ..... 539-540  
 Tenaculum ..... 776-777  
 Thoracic ..... 109-110, 387,  
 ..... 402, 404-405,  
 ..... 407-409, 456  
 Thru-Cutting ..... 706  
 Tissue ..... 54, 100-115,  
 ..... 117-118, 126-130,  
 ..... 304-309,  
 ..... 385-391,  
 ..... 396-397,  
 ..... 401-402, 495,  
 ..... 498, 504,  
 ..... 681-687,  
 ..... 796-797  
 Tongue Seizing ..... 150  
 Tonsil ..... 480, 718-719  
 Towel ..... 65-67  
 Traction ..... 146  
 Tube Occluding ..... 68-69  
 Tumor ..... 784  
 Turbinate ..... 619  
 Uterine Artery ..... 783  
 Uterine Polyp ..... 775  
 Uterine Vulsellum ..... 778  
 Utility ..... 530, 535-536  
 Vascular ..... 95, 102-103,  
 ..... 109, 264, 305,  
 ..... 385, 393-394,

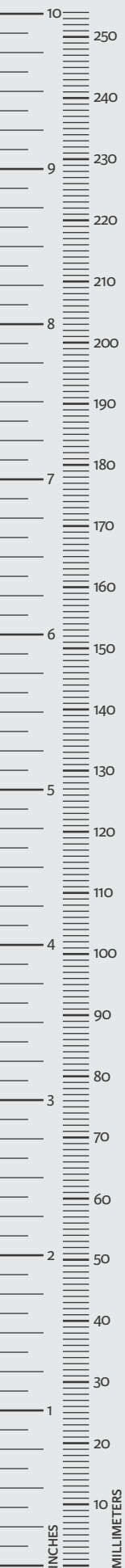

.....	396-397, 402,
.....	406, 410,
.....	456-458,
.....	476-477, 495,
.....	498, 797
Vascular Tissue .....	102-103,
.....	396-397, 797
Vulsellum .....	778
Wire Closure.....	589
Ford-Deaver Retractor .....	170
Foreign Body Spud .....	515
Fox Dermal Curette.....	155
<b>Frames</b>	
Mouth Gag .....	715
Retractor .....	336
Francis Chalazion Forceps .....	544
Francis Foreign Body Spud .....	514
Frazier (Schmeden) Dura Scissors.....	15, 344
Frazier Dura Hook.....	315
Frazier Dura Separator .....	317
Frazier Suction Tube.....	326-327, 586,
.....	702
Freeman Rhytidectomy Scissors.....	45, 667
Freeman-Gorney Face Lift Scissors .....	44, 666
Freeman-Kaye Face Lift Scissors.....	45, 667
Freer Chisel.....	610
Freer Elevator .....	320, 368, 702
Freer Septum Elevator.....	612
Freer Septum Knife.....	609-610
Friedman Rongeur .....	212
Frontal Ostium Seeker .....	711
Gardner Bone Chisel .....	736
Garland Hysterectomy Forceps .....	781
Garrett Dilator Case.....	425, 819
Garrett Dilator Holder .....	425, 822
Garrett Vascular Dilator .....	424
Garrett Vascular Retractor .....	195, 349
Gass Retinal Detachment Hook .....	519
Gelfoam Press.....	599
Gelpi Perineal Retractor .....	178-179, 640
Gemini Artery Clamp.....	145, 302, 403,
.....	457, 796
General Needle Pulling Forceps.....	96
Gerald Bipolar Forceps .....	312
Gerald Dressing Forceps .....	116-117, 309, 392
Gerald Forceps (Cardio-Grip) .....	309, 392, 504
Gerald Needle Pulling Forceps.....	96, 393
Gerald Stardust Forceps (Titanium) .....	504
Gerald Tissue Forceps .....	117, 309, 392,
.....	504
Gigli Saw Handle .....	244
Gigli Wire Saw Blade .....	244
Gill Corneal Knife.....	512

Gill Iris Forceps.....	527
Gillies Bone and Zygoma Hook .....	616
Gillies Skin Hook.....	632
Gillies Tissue Forceps .....	108, 686
Gillies Zygoma Elevator .....	616
Gills-Welsh Curette Capsule Polisher .....	514
Gills-Welsh Lens Loop .....	523
Gills-Welsh Vannas Scissors.....	558
Gil-Vernet Renal Sinus Retractor .....	757
Giraffe Frontal Sinus Forceps .....	708
Girard Corneo-Scleral Forceps .....	531
Glabella Rasp.....	696
Glassman Anterior Resection Clamp .....	138
Glassman Intestinal Clamp .....	137
Glover Auricular Appendage Clamp .....	442
Glover Bulldog Clamp.....	482-483
Glover Clamp.....	443
Glover Coarctation Clamp.....	449
Glover Patent Ductus Clamp.....	450
Gluck Rib Shears.....	362
Goelet Retractor .....	163
Goldman Displacer Septum Elevator.....	614
Goldman Dorsal or Septum Scissors .....	30, 649
Goldman Knife Guide and Retractors .....	633
Goldman Nasal Scissors .....	31, 651
Goldman Single Hook.....	631
Goldstein Lacrimal Sac Retractor.....	511
Gordon Uterine Vulsellum Forceps .....	778
Gorney Plastic Surgery Scissors .....	44, 666
Gorney Platysma Scissors.....	45, 667
Gorney Septum Suction Elevator.....	616
Gorney Turbinate Scissors.....	32, 652
Gosset Retractor .....	184
<b>Gouges</b>	
Bone .....	231
Hand.....	250
Hump .....	645
Lacrimal Sac .....	609
Mastoid.....	574
Spinal .....	232
Gradle Cilia Forceps.....	541
Gradle Stitch Scissors .....	27, 555
Graduated Measure.....	815
Graham Dura Hook .....	315
Grant Aortic Aneurysm Clamp.....	437
Graves Vaginal Specula .....	762
Green Fixation Forceps .....	529
Green Strabismus Hook.....	517
Green Thyroid Retractor .....	163
Gregory Bulldog Clamp .....	485
Gregory Miniature Vascular Clamp .....	458
Gregory Profunda Clamp.....	451, 471
Gregory Stay Suture Clamp.....	479
Grooved Director .....	153

Gross Ear Hook and Spoon ..... 572  
 Gruber Ear Specula..... 565  
 Gruenwald Nasal Dressing Forceps..... 120, 603  
 Gruenwald Nasal Forceps ..... 620

**Guides**  
 Catheter ..... 149  
 Drill ..... 343  
 Needle..... 789  
 Saw ..... 244  
 Guilford Scissors..... 592  
 Guthrie Fixation Hook ..... 519  
 Guthrie Hook ..... 630  
 Haight Rib Spreader ..... 352  
 Haight-Finochietto Rib Spreader ..... 352  
 Hajek-Koffler Punch ..... 709  
 Halle Elevator ..... 615  
 Halsey Needle Holder ..... 78, 84, 671, 674  
 Halstead Mosquito Forceps ..... 55-56, 679-680

**Hammers**  
 Ball Pean..... 239  
 Intranasal ..... 647  
 Neurological..... 151  
 Percussion ..... 151  
 Hanahan Extraction Forceps ..... 742

**Hand**  
 Chisel ..... 254  
 Drill ..... 255  
 Gouge..... 250  
 Lead ..... 211  
 Osteotome ..... 236  
 Retractor ..... 159, 161-174,  
 ..... 208, 210,  
 ..... 637-639,  
 ..... 764, 800

**Handles**  
 Knife ..... 70-73  
 Lifting..... 811  
 Saw ..... 244  
 Traction ..... 792  
 Hank Uterine Dilator ..... 768  
 Hardy Bipolar Forceps ..... 123-124, 314  
 Hardy Sella Punch..... 293  
 Harken Auricle Clamp ..... 443, 453  
 Harkin Rib Spreader ..... 355  
 Harms Suture Tying Forceps ..... 535, 536  
 Harms Trabeculotome ..... 561  
 Harrington Mixer Forceps ..... 409, 798  
 Harrington Splanchnic Retractor ..... 169  
 Harrington-Pemberton Retractor ..... 169  
 Hartman Alligator Ear Forceps..... 567-568  
 Hartman Biopsy Forceps..... 773

Hartman Ear Dressing Forceps ..... 566  
 Hartman Ear Specula ..... 565  
 Hartman Mosquito Forceps ..... 56, 680  
 Hartman Nasal Dressing Forceps ..... 604  
 Hartman Nasal Speculum ..... 601, 703  
 Hartman Rongeur ..... 213, 577  
 Hartman (Meltzer) Adenoid Punch ..... 700  
 Hartman-Herzfeld Alligator Ear Forceps 567  
 Hartmann Tuning Fork ..... 569  
 Hausmann Clamp ..... 139-140  
 Haverfield-Scoville Retractor Frame ..... 336  
 Hayes Hand Retractor ..... 208  
 Heaney Hysterectomy Forceps ..... 780, 782  
 Heaney Hysterectomy Retractor ..... 766  
 Heaney Needle Holder ..... 80, 91, 799  
 Heaney Uterine Biopsy Curette ..... 771  
 Heaney-Ballentine Hysterectomy Forceps  
 ..... 781  
 Heaney-Rezek Hysterectomy Forceps .... 781  
 Heaney-Simon Hysterectomy Retractor 766  
 Heath Chalazion Forceps..... 543  
 Heath Suture Scissors ..... 13, 98  
 Heavy Duty Locking Plier ..... 261  
 Heavy Duty Needle Nose Locking Plier.. 262  
 Hegar Uterine Dilator ..... 767  
 Hegar-Baumgartner Needle Holder ..... 77, 83, 670, 673  
 Hegenbarth Clip Applying Forceps ..... 97  
 Heidbrink Root-Tip Pick ..... 738  
 Heiss Artery Forceps..... 405  
 Heiss Automatic Skin Retractor..... 178, 640

**Hemostats**  
 Forceps..... 55-64, 146, 302,  
 ..... 403, 447,  
 ..... 456-457, 477,  
 ..... 479, 680-681,  
 ..... 754  
 Halstead Mosquito..... 55-56, 679-680  
 Tracheal..... 729  
 Vasesctomy..... 757  
 Henly Retractor ..... 194-195, 348  
 Henly Vacular Clamp ..... 452  
 Henner Elevator ..... 581  
 Hennig Cast Spreader ..... 201  
 Henrotin Uterine Vulsellum Forceps..... 778  
 Heparin Flushing Needle..... 423  
 Hercules Plaster Shears ..... 200  
 Hercules Supercutter ..... 257  
 Herrick Kidney Clamp ..... 454, 759  
 Hexagonal Handle Osteotome ..... 646  
 Hibbs Blade ..... 337  
 Hibbs Chisel ..... 229  
 Hibbs Gouge ..... 230  
 Hibbs Osteotome ..... 229-230  
 Hibbs Retractor ..... 169



- Hibbs-Bruns Curette Rack ..... 227, 816
- Hill-Ferguson Rectal Retractor ..... 749
- Himmelstein Sternal Retractor ..... 356
- Hirschman Anoscope ..... 748
- Hirschman Iris Hook ..... 516
- Hirschman Iris Lens Spatula ..... 521
- Hoehn Alligator Forceps ..... 303
- Hoehn Dressing Forceps ..... 116, 306
- Hoehn Dura Separator ..... 317
- Hoehn Nerve Hook ..... 316
- Hoehn Periosteal Elevator ..... 319
- Hoehn Retractor ..... 335
- Hohmann Retractor ..... 209
- Hoke Osteotome Rack ..... 228, 817
- Hoke Osteotome ..... 234
- Holders**
- Clamp ..... 136
- Dilator ..... 425, 822
- Forceps ..... 814
- Instrument ..... 812-814
- Needle ..... 52-53, 76-93,  
..... 256, 266-267,  
..... 269-270,  
..... 279-283,  
..... 412-420,  
..... 493-494,  
..... 496-497, 502,  
..... 546-548,  
..... 669-677, 799
- Hollenbach Plugger, Double Ended ..... 733
- Holscher Nerve Retractor ..... 325
- Hooks**
- Bone ..... 225
- Bypass ..... 429
- Crypt ..... 753
- Detachment ..... 519
- Dura ..... 274, 315-316,  
..... 318, 368
- Ear ..... 572
- Elevator ..... 632
- Fixation ..... 516, 519-520
- Gasserian Ganglion ..... 316
- Incus ..... 572
- Iris ..... 516, 518-519
- Muscle ..... 517
- Nerve ..... 273, 316, 368,  
..... 429
- Palate ..... 632
- Rhoto-Type ..... 276, 500
- Single Prong ..... 632
- Skin ..... 518, 630-632
- Strabismus ..... 517
- Sympathectomy ..... 317, 368
- Tenaculum ..... 779
- Tenotomy ..... 517
- Tracheal ..... 728
- Zygoma ..... 616
- Horizontal Retractor ..... 211
- Horsley Dura Separator ..... 317
- Hough Crura Nipper ..... 589
- House Alligator Ear Forceps ..... 587-588
- House Crimper Forceps ..... 587
- House Curette ..... 598
- House Elevator ..... 596
- House Footplate Chisel ..... 594
- House Hand Retractor ..... 159, 591
- House Hook ..... 592
- House Incudostapedial Joint Knife ..... 597
- House Lancet Knife ..... 597
- House Middle Ear Mirror ..... 592
- House Miniature Cup Forceps ..... 587
- House Myringotomy Knife ..... 598
- House Needle ..... 593
- House Obtuse Pick ..... 592
- House Oval Window Pick ..... 595
- House Pick ..... 596
- House Sickle Knife ..... 598
- House Strut Caliper ..... 594
- House Strut Forceps ..... 587
- House Strut Pick ..... 595
- House Suction Adapter ..... 584
- House Suction Irrigator ..... 584
- House Tympanoplasty Knife ..... 597
- House Wire Strut Guide ..... 594
- House-Barbara Pick ..... 595
- House-Bellucci Alligator Scissors ..... 588
- House-Crabtree Dissector ..... 596
- House-Crabtree Dissector Pick "Jimmy" ..... 596
- House-Dieters Malleus Nipper ..... 589
- House-Hough Excavator ..... 594
- House-Rosen Needle ..... 593
- House-Sheehy Knife Curette ..... 593
- Howard Bone File ..... 735
- Howard-DeBakey Aortic Aneurysm Clamp  
..... 434
- Hudson Brace ..... 342
- Hudson Cranial Drill Set ..... 342
- Hufnagel-Ryder Needle Holder ..... 88, 415
- Hulka Tenaculum Forceps ..... 777
- Hunt Chalazion Forceps ..... 543
- Hunter Uterine Curette ..... 770
- Hurd Dissector and Pillar Retractor ..... 719
- Identification Tag ..... 810
- Inge Lamina Spreader ..... 334
- Ingrown Nail Cutter ..... 251
- Ingrown Nail Splitting Scissors ..... 252
- Initial Incision (Charnley) Retractor Set ..... 210
- In-Situ Bypass Hook ..... 429

Instrument Holding Rack ..... 808, 813, 818  
 Instrument Stringer..... 813  
 Instrument Tray..... 811  
 Instrument Tip-It Protectors..... 822

**Intestinal**

Clamp ..... 133-137, 139-140  
 Locking Device ..... 135  
 Scissors ..... 14, 145  
 Iodine Cup ..... 815  
 Iowa Membrane Puncturing Forceps..... 789  
 Iowa Trumpet Pudendal Needle Guide... 789  
 Iris Forceps..... 118, 526  
 Iris Scissors..... 22-24, 40, 43,  
 ..... 549-551,  
 ..... 656-658,  
 ..... 663-664  
 Israel Retractor ..... 177  
 Jackson Laryngeal Dressing Forceps..... 725  
 Jackson Nasal Bone Scissors ..... 32, 651  
 Jackson Rongeur ..... 298  
 Jackson Tracheal Hemostat..... 729  
 Jackson Tracheal Hook..... 728  
 Jackson Tracheal Retractor ..... 728  
 Jackson Tracheal Tube..... 729-730  
 Jackson Vaginal Retractor ..... 764  
 Jacobs Uterine Vulsellum Forceps ..... 778  
 Jacobson Bipolar Forceps..... 311  
 Jacobson Bulldog Clamp ..... 486  
 Jacobson Forceps ..... 116, 270  
 Jacobson Instrument..... 271  
 Jacobson Micro Scissors..... 268-269,  
 ..... 382-384  
 Jacobson Needle Holder..... 269  
 Jacobson Scissors ..... 268  
 Jacobson Stardust Needle Holder ..... 281-283, 497  
 Jaffe Lid Retractor ..... 512  
 Jako Micro-Laryngeal Cup Forceps ..... 726  
 Jako Micro-Laryngeal Grasping Forceps. 726  
 Jako Micro-Laryngeal Scissors..... 727  
 Jameson Caliper ..... 559  
 Jameson Muscle Hook ..... 517  
 Jameson Muscle Recession Forceps..... 545  
 Jamison Scissors ..... 47  
 Jamison-Metzenbaum Scissors ..... 10, 373  
 Jansen Ear Dressing Forceps..... 119, 566  
 Jansen Nasal Dressing Forceps ..... 119, 603  
 Jansen Retractor..... 329, 590  
 Jansen-Middleton Septum Forceps ..... 623  
 Jansen-Zaufel Rongeur ..... 216  
 Jarit Aortic Aneurysm Clamp..... 437  
 Jarit Micro Forceps..... 503  
 Jarit Micro Stardust Needle Holder ..... 496-497, 502  
 Jarit Micro Stardust Ring Forceps ..... 503  
 Jarit Periosteal Elevator ..... 318, 613

Jarit Stardust Micro Forceps ..... 284  
 Jarit Stardust Micro Ring Forceps ..... 285, 503  
 Jarit Stardust Micro Suture Forceps ..... 284, 286, 505  
 Jarit Stardust Needle Holder ..... 279-280, 282,  
 ..... 493  
 Javid Carotid Artery Clamp ..... 480  
 Jennings Mouth Gag ..... 714  
 Jewelers Bipolar Forceps ..... 121, 312-313  
 Jewelers Style Forceps..... 506, 533-534  
 Jeweler-Type Forceps ..... 312  
 John Hopkins Bulldog Clamp..... 427  
 Johnson Skin Hook..... 632  
 Jones Adenoid Curette ..... 698  
 Jones Forceps ..... 62  
 Jones Thoracic Clamp ..... 410  
 Jones Towel Forceps ..... 66  
 Jorgenson Scissors ..... 16, 370  
 Joseph Button End Knife ..... 628  
 Joseph Nasal Knife..... 628  
 Joseph Nasal Saw..... 689  
 Joseph Periosteal Elevator ..... 614  
 Joseph Rasp ..... 692  
 Joseph Scissors ..... 9, 605, 654  
 Joseph Skin Hook ..... 631  
 Judd-Allis Tissue Forceps..... 127  
 Judd-Masson Blade Retractor ..... 756  
 Juers-Lempert Rongeur ..... 214, 578  
 Julian Artery Forceps ..... 405  
 Julian Needle Holder ..... 90, 418  
 Kalt Needle Holder ..... 546  
 Kantrowitz Thoracic Forceps ..... 402  
 Karmody In-Situ Valve Scissors ..... 21, 381  
 Kartchner Internal Carotid Clamp..... 470  
 Katzin Corneal Transplant Scissors ..... 558  
 Kay Aorta Clamp ..... 439  
 Kaye Dissecting Scissors..... 31, 650  
 Kaye Face Lift Scissors ..... 44, 666  
 Kelly Artery Forceps..... 58  
 Kelly Fistula Scissors ..... 9, 754  
 Kelly Placenta Forceps..... 789  
 Kelly Proctoscope ..... 748  
 Kelly Retractor..... 168  
 Kelly Uterine Scissors..... 787  
 Kelman-McPherson Micro Corneal Forceps  
 ..... 539  
 Kelman-McPherson Suture Tying Forceps  
 ..... 539  
 Kern Bone Holding Clamp..... 202  
 Kerrison Cervical Rongeur..... 290  
 Kerrison Cervical Rongeur, Detach ..... 291  
 Kerrison Mastoid Rongeur ..... 575  
 Kerrison Rongeur..... 288-293  
 Kerrison Rongeur, Spurling ..... 291-293  
 Kerrison-Costen Rongeur..... 575  
 Kevorkian-Young Biopsy Forceps ..... 774





- Kevorkian-Younger Endocervical Biopsy Curette ..... 771  
 Key Elevator ..... 240  
 Keyes Dermal Punch Set ..... 155  
 Keyes Dermal Punch ..... 155  
 Kieland Obstetrical Forceps ..... 791  
 Kiene Bone Tamp ..... 239  
 Killian (Von Eicken) Antrum Cannula ..... 608  
 Killian Septum Forceps ..... 622  
 Killian Septum Specula ..... 601, 703  
 Kilner Skin Hook ..... 631  
 Kimura Platinum Spatula ..... 521  
 King Adenoid Punch ..... 701  
 Kirk Mallet ..... 238  
 Kitzmiller Clamp ..... 468, 492  
 Kleinert-Kutz Elevator and Dissector ..... 615  
 Kleinert-Kutz Rasp ..... 693  
 Kleinert-Kutz Skin Hook ..... 630  
 Kleinert-Kutz Tendon Retriever ..... 249  
 Knapp Iris Scissors ..... 22, 549, 656  
 Knapp Retractor ..... 158, 637  
 Knife Handles ..... 70-73  
 Knife Handle #3 ..... 70  
 Knife Handle #3L ..... 71  
 Knife Handle #3LA ..... 72  
 Knife Handle #4 ..... 70  
 Knife Handle #4L ..... 72  
 Knife Handle #7 ..... 71  
 Knife Handle #9 (7K) ..... 72  
 Knight Nasal Dressing Forceps ..... 604  
 Knight Nasal Scissors ..... 28, 43, 605,  
 ..... 665, 703-704  
 Knight Polypus and Turbinate Forceps ... 619
- Knives**
- Amputating ..... 207  
 Button End ..... 628-629  
 Corneal ..... 512  
 Discission ..... 512  
 Dissector ..... 321  
 Ear ..... 573  
 Graft ..... 512  
 Guide and Retractor ..... 633  
 Handles ..... 72-75  
 Meniscus ..... 246  
 Myringotomy ..... 574  
 Nasal ..... 629  
 Septum ..... 609-610  
 Sickel ..... 711  
 Sternum ..... 367  
 Swivel ..... 610  
 Tonsil ..... 720  
 Knolle Iris Hook ..... 519  
 Knolle Lens Nucleus Spatula ..... 520  
 Knowles Finger Bandage Scissors ..... 11
- Kocher Artery Forceps ..... 62, 681  
 Kogan Endocervical Speculum ..... 769  
 Kratz-Barraquer Eye Speculum ..... 508  
 Krause Ear Snare ..... 570  
 Krause Nasal Snare ..... 606  
 Krayenbuehl Dura Hook ..... 274  
 Krayenbuehl Nerve Hook ..... 273  
 Krayenbuehl Twist Hook ..... 274  
 Kuglen Iris Hook and Lens Manipulator ..... 519  
 La Borde Tracheal Dilator ..... 727  
 La Force Adenotome ..... 698  
 La Force Foreign Body Spud ..... 515  
 Lachrymal Cannula ..... 561  
 Lahey Clinic Dura Hook ..... 315  
 Lahey Gall Duct Forceps ..... 142, 407  
 Lahey Hemostat ..... 146  
 Lahey Retractor ..... 633  
 Lahey Thoracic Forceps ..... 407  
 Lahey Thyroid Retractor ..... 164  
 Lahey Traction Forceps ..... 146  
 Lambert Aortic Aneurysm Clamp ..... 436  
 Lambert Chalazion Forceps ..... 543  
 Lambert-Kay Aorta Clamp ..... 439, 492  
 Lambert-Lowman Bone Holding Clamp ..... 206  
 Lambotte Bone Holding Clamp ..... 204  
 Lambotte Mini Osteotome Rack ..... 236, 817  
 Lambotte Mini Osteotome Set ..... 236  
 Lambotte Mini Osteotome ..... 237  
 Lambotte Osteotome Rack ..... 227, 816  
 Lambotte Osteotome ..... 234  
 Lamina Spreader ..... 333
- Laminectomy**
- Retractor ..... 184, 332, 338  
 Rongeur ..... 288-293  
 Lancaster Eye Speculum ..... 509  
 Lane Bone Holding Clamp ..... 202  
 Lane Elevator ..... 241  
 Langenbeck Elevator ..... 241  
 Langenbeck Metacarpal Saw ..... 245  
 Langenbeck Retractor ..... 163  
 Laparoscopic Instrument Case ..... 821  
 Laparotomy Ring ..... 152  
 Large Pin Cutter ..... 259  
 Large Snap-On Basket Tag (with Key Ring)  
 ..... 810  
 Larry Rectal Probe and Director ..... 753
- Laryngeal**
- Dilator ..... 727  
 Forceps ..... 718, 725  
 Mirror ..... 725  
 Retractor ..... 744  
 Laufe Uterine Polyp Forceps ..... 775  
 Lawrence Forceps ..... 404

Lead hand ..... 211  
 Lebsche Sternum Knife ..... 367  
 Lee Right Angle Clamp ..... 452  
 Leksell Rongeur ..... 218, 366  
 Leland Jones Peripheral Vascular Clamp ..... 445  
 Lemmon Intima Dissector ..... 427  
 Lemmon Sternal Approximator ..... 359  
 Lemole-Strong Aorta Clamp ..... 436  
 Lempert Elevator ..... 580  
 Lempert Endaural Curette ..... 571  
 Lempert Rongeur ..... 214, 578  
 Lester Fixation Forceps ..... 529  
 Lewin Bone Holding Clamp ..... 204  
 Lewis Lens Loop ..... 523  
 Lewis Rasp ..... 692  
 Lewis Septum Forceps ..... 622  
 Lichtwicz Antrum Trocar Needle ..... 607  
 Lifting Handle ..... 811

**Ligature**

Carrier ..... 97, 274, 411, 642  
 Lillehei-Potts Scissors ..... 7, 47, 372  
 Lillie Tonsil Scissors ..... 34, 721  
 Lincoln Vascular Scissors ..... 18, 376  
 Lister Banadage Scissors ..... 11  
 Liston Amputating Knife ..... 207  
 Liston Bone Cutting Forceps ..... 221  
 Littauer Cilia Forceps ..... 541  
 Littauer Stitch Scissors ..... 13, 99  
 Littauer-Liston Bone Cutting Forceps ..... 220  
 Little Retractor ..... 163  
 Littler Suture Carrying Scissors ..... 33, 652  
 Locke Elevator ..... 251  
 Locke Phalangeal Forceps ..... 248  
 Locking Plier ..... 261-262  
 Lockwood-Allis Tissue Forceps ..... 128  
 Long Hysterectomy Forceps ..... 783

**Loops**

Lens ..... 523  
 Nucleus ..... 523  
 Shunt ..... 482  
 Lordan Chalazion Forceps ..... 544  
 Lothrop Tonsil Knife and Dissector ..... 720  
 Lothrop Uvula Retractor ..... 701  
 Love Gruenwald Pituitary Rongeur ..... 294  
 Love Nerve Retractor ..... 324  
 Love Uvula Retractor ..... 701  
 Love-Adson Periosteal Elevator ..... 318  
 Lovelace Lung Forceps ..... 401  
 Low Ryder Needle Holder ..... 419  
 Lower Gall Duct Forceps ..... 142  
 Lower Lateral Scissors ..... 29, 648  
 Lowman Bone Holding Clamp ..... 206  
 Lucae Ear Dressing Forceps ..... 119, 566

Lucae Mallet ..... 238  
 Lucas Bone Curette ..... 735  
 Luer Lock Adaptor ..... 423  
 Luer Rongeur ..... 212, 576  
 Luer Tracheal Retractor ..... 728  
 Luikhart Obstetrical Forceps ..... 791  
 Lukens Thymus Retractor ..... 728

**Lung**

Forceps ..... 401  
 Retractor ..... 348  
 Magill Catheter Forceps ..... 150  
 Magnetic Eye Probe ..... 515  
 Maliniac Nasal Retractor ..... 636

**Mallets**

Bone ..... 237-239  
 Copper Head ..... 646  
 Plastic and Recon ..... 237, 646-647  
 Mallet w/Nylon Head ..... 237, 646  
 Maltz Button End Knife ..... 629  
 Maltz Rasp ..... 691  
 Maltz-Anderson Rasp ..... 691  
 Markham-Meyerding Hemilaminectomy Retractor ..... 184, 333  
 Martin Cartilage Clamp ..... 246  
 Martin Cartilage Scissors ..... 14, 246  
 Martin Pelvimeter ..... 789  
 Martini Bone Curette ..... 251  
 Masson Needle Holder ..... 79, 88, 415  
 Masterson Hysterectomy Forceps ..... 782  
 Mastin Muscle Clamp ..... 146  
 Mathieu Needle Holder ..... 92  
 Mathieu Raspatory ..... 243  
 Mathieu Retractor ..... 158, 637

**Mastoid**

Rongeur ..... 575  
 Matson-Alexander Rib Stripper ..... 367  
 Matson Rib Stripper ..... 367  
 Mattox-Potts Scissors ..... 18, 377  
 Maumenee-Park Eye Speculum ..... 510  
 Mayfield Spatula ..... 328  
 Mayo (Guyon) Vessel Clamp ..... 454, 758  
 Mayo Abdominal Retractor ..... 169  
 Mayo Scissors ..... 5-6, 37, 42, 787-788, 794  
 Mayo Trays, Perforated ..... 811  
 Mayo Uterine Scissors ..... 787  
 Mayo-Adams Retractor ..... 183  
 Mayo-Collins Retractor ..... 161  
 Mayo-Harrington Scissors ..... 16, 37, 370-371, 788  
 Mayo-Hegar Needle Holder ..... 79, 86, 413-414, 799



- Mayo-Noble Dissecting Scissors..... 6  
 Mayo-Robson Intestinal Forceps..... 134  
 Mayo-Russian Tissue Forceps..... 111  
 McBurney Thyroid Retractor..... 163  
 McClure Iris Scissors ..... 556  
 McCrea Infant Urethral Sound ..... 760  
 McCullough Utility Forceps ..... 535  
 McGee Wire Closure Forceps..... 589  
 McGiveny Hemorrhoidal Grasping Forceps  
 ..... 751  
 McGiveny Hemorrhoidal Ligator ..... 751  
 McGiveny Ligator Set ..... 751  
 McGlamry Elevator..... 242  
 McIndoe Dressing Forceps..... 108, 686  
 McIvor Mouth Gag..... 716  
 McKenty Punch..... 709  
 McKenty Septal Elevator ..... 611  
 McKenzie Enlarging Burr ..... 343  
 McKenzie Perforator Drill ..... 343  
 McLane-Tucker Obstetrical Forceps ..... 791  
 McLane-Tucker-Luikhart Obstetrical Forceps  
 ..... 792  
 McPherson Eye Speculum..... 508  
 McPherson Micro Corneal Forceps..... 538  
 McPherson Needle Holder..... 548  
 McPherson Suture Tying Forceps..... 538  
 McPherson-Vannas Iris Scissors..... 558  
 Mead Mallet ..... 239  
 Mead Rongeur ..... 743  
 Mediastinal Dissecting Forceps..... 432  
 Medicine Cup..... 815  
 Meeker Artery Clamp..... 144, 404  
 Metzenbaum (Baby) Scissors..... 8, 654  
 Metzenbaum (Nelson) Scissors..... 16, 39, 369  
 Metzenbaum Scissors..... 8, 39, 42, 47,  
 ..... 344, 369,  
 ..... 373-374, 654,  
 ..... 662-664, 722,  
 ..... 794  
 Metzenbaum Lahey Scissors ..... 7, 9, 38, 42, 653,  
 ..... 373, 654, 661,  
 ..... 664  
 Meyerding Blade..... 337  
 Meyerding Finger Retractor ..... 159  
 Meyerding Hip and Shoulder Skid ..... 208  
 Meyerding Retractor ..... 170, 184, 333,  
 ..... 637, 638  
 Meyerding Skin Hook and Retractor ..... 158  
 Meyhoeffer Chalazion Curette ..... 514  
 Michel Clip Applying/Removing Forceps..... 97  
 Michel Skin Clip..... 97  
 Michele Trepine..... 343  
 Micro Alligator Ear Forceps ..... 588, 589  
 Micro Clamps, Pediatric..... 461-464,  
 ..... 488-491  
 Micro Forceps..... 399  
 Micro Friedman Rongeur..... 212, 576  
 Micro Needle Holder..... 418  
 Micro Ring Forceps..... 400  
 Micro Stitch Scissors..... 555  
 Micro Suture Tying Forceps..... 264, 398
- Microlaryngeal**
- Cup Forceps..... 726  
 Grasping Forceps ..... 726  
 Scissors ..... 727
- Microsurgical**
- Clamp..... 461-462,  
 ..... 488-491  
 Forceps..... 116, 264, 267,  
 ..... 270, 398-400,  
 ..... 503, 588-589  
 Instrument..... 271-272  
 Ligature Carrier..... 274  
 Needle Holder..... 266-267, 418  
 Rongeur ..... 212, 288-289,  
 ..... 303, 576, 743  
 Scissors ..... 265, 267-269,  
 ..... 303, 377,  
 ..... 382-384, 555  
 Microvascular Needle Holder ..... 91, 418, 493
- Middle Ear**
- Adaptor ..... 584  
 Caliper..... 594  
 Chisel ..... 594  
 Curette ..... 593, 598  
 Dissector..... 596  
 Elevator ..... 596  
 Excavator ..... 594  
 Forceps..... 587-588  
 Guide..... 594  
 Hook..... 592  
 Irrigator..... 584  
 Knife ..... 597-598  
 Mirror ..... 592  
 Needle..... 593  
 Nipper ..... 589  
 Pick ..... 592, 595-596  
 Retractor..... 159, 591  
 Scissors ..... 588, 592  
 Middleton Adenoid Curette ..... 699  
 Miller Dissecting Scissors ..... 31, 650  
 Miller Rasp..... 245  
 Miller Retractor..... 158, 639  
 Mills Coronary Tissue Forceps ..... 387  
 Mills Endarterectomy Spatula ..... 429  
 Mini-Blumenthal Rongeur ..... 743  
 Mini-Hohmann Retractor..... 209

Miskimon Retractor ..... 329  
 Mixer Forceps ..... 143, 407-409,  
 ..... 456  
 Mixer Forceps, Pediatric ..... 143, 407, 456  
 Molt Bone Curette ..... 735  
 Molt Periosteal Elevator ..... 580  
 Morse Sternal Retractor ..... 356  
 Mosquito Forceps (Thoracic) ..... 405

**Mouth Gags**

Dental ..... 744  
 Throat ..... 714  
 Murphy Gall Bladder Retractor ..... 167, 764  
 Murphy Retractor ..... 177  
 Murphy-Lane Bone Skid ..... 208  
 Myringotomy Knife ..... 573  
 Nabatoff Vein Stripper ..... 146, 430  
 Nabatoff Vein Stripper (Case Only) ..... 819  
 Nail Nipper ..... 155-156, 254  
 Nail or Bone Rasp ..... 251  
 Nail Scissors ..... 156  
 Nail Splitter, English Anvill Pattern ..... 156  
 Nail Splitter ..... 250  
 Nasal Alligator Scissors ..... 707

**Nasal**

Adenotome ..... 698  
 Cutting Forceps ..... 625  
 Dressing Forceps ..... 604  
 Elevator ..... 581  
 Forceps ..... 119-120,  
 ..... 603-604,  
 ..... 620-621,  
 ..... 624-625, 705,  
 ..... 707  
 Knife ..... 628  
 Rasp ..... 608, 691-695  
 Retractor ..... 636, 701  
 Saw ..... 689  
 Scissors ..... 28, 31, 43, 605,  
 ..... 665, 703-704,  
 ..... 707  
 Snare ..... 606  
 Speculum ..... 600-601, 703

**Needle**

Antrum Trocar ..... 607  
 Biopsy ..... 151  
 Flushing ..... 423  
 Holder ..... 52-53, 76-93,  
 ..... 256, 266-267,  
 ..... 269-270,  
 ..... 279-283,  
 ..... 412-420,  
 ..... 493-494,

..... 496-497, 502,  
 ..... 546-548,  
 ..... 669-677, 799  
 Pulling Forceps ..... 95-96, 113, 249,  
 ..... 252, 256, 307,  
 ..... 390, 393-395,  
 ..... 688  
 Rhoton-Type ..... 276, 500  
 Septum ..... 711  
 Needle Nose Pliers ..... 260  
 Neivert Knife Guide and Retractor ..... 633  
 Neivert Needle Holder ..... 76, 82, 669, 672  
 Neivert Osteotome ..... 645  
 Nelson Tissue Forceps ..... 110, 385, 687

**Nerve**

Hook ..... 273, 316, 368  
 Retractor ..... 324-325

**Neurosurgical**

Blade ..... 338  
 Drill ..... 342  
 Elevator ..... 320, 322, 368,  
 ..... 702  
 Forceps ..... 303  
 Retractor ..... 329, 335, 341,  
 ..... 590  
 Rongeur ..... 293, 297-299  
 Scissors ..... 15, 344  
 Separator ..... 323  
 Spatula ..... 328  
 Trepine ..... 343  
 New Orleans Lens Loop ..... 523  
 New Orleans Needle Holder ..... 78, 84  
 New's Suture Scissors ..... 12, 98  
 News Tracheal Hook ..... 728

**Nippers**

Crura ..... 589  
 Cuticle ..... 156, 253  
 Nail ..... 155-156, 254  
 Tissue ..... 253  
 No Scalpel Vasectomy Hemostat ..... 757  
 No Scalpel Vasectomy Ring Clamp ..... 757  
 Non-Perforating Towel Clamp ..... 66  
 Noon AV Fistula Clamp ..... 458  
 Novak Endometrial Biopsy Suction Curette  
 ..... 771  
 Noyes Nasal Dressing Forceps ..... 604  
 Nucleus Knife ..... 254  
 Nugent Utility Forceps ..... 535  
 Nylon Cap ..... 646  
 O'Brien Suture Scissors ..... 14, 27, 99,  
 ..... 555, 655  
 Ochsner Aorta Clamp ..... 438



Ochsner Forceps ..... 402, 456, 476  
 Ochsner Vascular Retractor..... 196, 349  
 O'Connor Hook..... 518, 630  
 Oldberg Dissector..... 318  
 Olivecrona Dissector ..... 428  
 Ollier Retractor..... 177  
 Olsen-Hegar Needle Holder/Scissors .... 79, 87  
 Operating Scissors ..... 2-4, 37  
 Oral Surgery Rongeur ..... 743  
 Orthopedic Mallet..... 238

**Osteotomes**

Bone ..... 231, 234  
 Hand Surgery ..... 236  
 Mini ..... 237  
 Plastic Surgery ..... 643-647  
 Rack..... 227-228, 236,  
 ..... 817  
 Ostium Seeker Ball End Elevator ..... 611, 704  
 Ostrum Antrum Punch..... 710  
 Ostrum Antrum Suction Punch..... 710  
 O'Sullivan-O'Connor Abdominal Retractor  
 ..... 193  
 O'Sullivan-O'Connor Vaginal Retractor.. 764  
 Otis Urethrotome ..... 755  
 Overstreet Endometrial Polyp Forceps ... 775  
 Packer and Excavator ..... 254

**Pans**

Autoclaving ..... 812  
 Par Style Plastic and Recon Needle Holder  
 ..... 83, 674  
 Par Style Plastic and Recon Scissors ..... 46, 668  
 Parallel Pliers ..... 260  
 Parametrium Scissors..... 40, 779  
 Parker Retractor ..... 162  
 Parker-Mott Retractor..... 162  
 Parkes Hump Gouge ..... 645  
 Parkes Osteotome ..... 645  
 Parkes Rasp..... 691  
 Park-Guyton Eye Speculum..... 510  
 Parsonnet Epicardial Retractor ..... 347

**Passers**

Chest Tube..... 478  
 Tendon ..... 248-249  
 Wire ..... 642  
 Paufigue Garft Knife..... 512  
 Payr Pylorus Clamp..... 137  
 Pean Forceps..... 132, 795  
 Peapod (Bead-Type) Forceps ..... 298  
 Pederson Vaginal Specula ..... 762

**Pediatric**

Clamps ..... 459, 461-462,  
 ..... 466, 472,  
 ..... 488-491  
 Retractor ..... 170  
 Sinus Forceps ..... 705-707  
 Peers Towel Forceps ..... 67  
 Penfield Dissector..... 319, 368  
 Pennington Forceps ..... 64, 754  
 Pennington Septal Elevator ..... 611  
 Pennington Tissue Forceps ..... 401

**Periosteal**

Elevator ..... 240, 242, 318,  
 ..... 580-581,  
 ..... 613-614

**Periosteotome**

Rib..... 367  
 Perkins Retractor ..... 590  
 Petit-Point Allis Tissue Forceps..... 54, 126, 681  
 Petit-Point Babcock Forceps ..... 54, 129, 682  
 Petit-Point Crile Forceps ..... 51, 678  
 Petit-Point Jacobson Mosquito Forceps. 50, 301, 402,  
 ..... 476, 678  
 Petit-Point Mixer Forceps..... 54, 143,  
 ..... 407-408, 456,  
 ..... 682  
 Petit-Point Mosquito Forceps..... 50-51, 301-302,  
 ..... 476, 678  
 Petit-Point Ochsner Forceps ..... 51, 679  
 Petit-Point Olsen-Hegar Needle Holder/Scissors  
 ..... 52, 79, 87, 671,  
 ..... 675  
 Petit-Point Pean Forceps..... 51, 679  
 Petit-Point Reynolds Scissors ..... 38, 52, 374-375,  
 ..... 662  
 Petit-Point Ryder Needle Holder ..... 53, 88, 414-415,  
 ..... 675  
 Petit-Point Sarot Needle Holder..... 53, 90, 417  
 Phaneuf Uterine Artery Forceps ..... 783

**Picks**

Awl ..... 235  
 Fixation ..... 520  
 Root Tip ..... 738  
 Pierce Elevator..... 610  
 Pierser Colibri Forceps..... 532  
 Piffard Dermal Curette ..... 155  
 Piper Obstetrical Forceps ..... 792  
 Plain Rib Shears ..... 362  
 Plain Splinter Forceps..... 125  
 Plaque Retriever..... 430



**Plaster**

Cast Breaker ..... 201  
 Cast Shearer ..... 200  
 Cast Spreader ..... 201-202  
 Plastic Filling Instrument..... 734

**Plastic Surgery**

Chisel ..... 643-644  
 Clamps ..... 696  
 Crusher ..... 626  
 Elevator ..... 613-614  
 Forceps ..... 625  
 Hook..... 630-632  
 Knife ..... 628-629  
 Needle Holder..... 83, 674  
 Osteotome ..... 643-647  
 Rasp ..... 690  
 Retractor ..... 633-641  
 Scissors ..... 10, 30-33,  
 ..... 43-48, 648-655,  
 ..... 665-668  
 Platypus Nail Pulling Forceps..... 252

**Pliers**

Flat Nose..... 261  
 Locking ..... 261-262  
 Needle Nose..... 260  
 Pin Removal..... 260  
 Utility..... 260

**Podiatry**

Bone File ..... 254  
 Elevator ..... 251  
 Forceps ..... 248  
 Knife ..... 254  
 Nipper ..... 254  
 Probe and Packer ..... 252  
 Rasp ..... 251  
 Splitter ..... 250  
 Polack Double Corneal Forceps ..... 536  
 Politzer Ear Knife..... 573  
 Polokoff Bone File..... 253  
 Pomeroy Ear Syringe ..... 583  
 Poole Suction Tube..... 147-148, 800  
 Posilock Instrument Holder ..... 813  
 Potts Arteriotomy Scissors ..... 382  
 Potts T-Handle Elevator ..... 738  
 Potts-Smith Dissecting Scissors..... 17, 375  
 Potts-Smith Dressing Forceps..... 109, 388  
 Potts-Smith Tissue Forceps..... 109-110, 388  
 Potts-Smith Vascular Scissors..... 19, 48, 378  
 Pratt Ethmoid Curette ..... 617  
 Pratt Rectal Probe ..... 753  
 Pratt Rectal Speculum..... 746  
 Pratt Smith T-Clamp..... 63, 754

Pratt Uterine Dilator..... 768  
 Presbyterian Hospital Elevator ..... 320  
 Presbyterian Hospital Tube Occluding Forceps  
 ..... 68

**Presses**

Fascia..... 599  
 Preston Ligamentum Flavum Forceps..... 247  
 Probe and Packer ..... 252

**Probes**

Director ..... 153  
 Double Ended ..... 152  
 Eye ..... 515  
 Fistula..... 753  
 Lacrimal ..... 560  
 Pigtail ..... 561  
 Rectal..... 753  
 With Eye..... 152  
 Providence Hospital Forceps..... 59, 681

**Punches**

Antrum ..... 710  
 Cervical ..... 774  
 Dermal ..... 155  
 Neurosurgical..... 293  
 Sinoscopy ..... 709  
 Putti Rasp..... 245  
 Quimby Gum Scissors..... 744  
 Quisling Intranasal Hammer..... 647  
 Rabiner Neurological Hammer..... 151

**Racks**

Bone ..... 228, 817  
 Curette ..... 227-228,  
 ..... 816-817  
 Holding ..... 808, 813, 818  
 Lambotte ..... 816  
 Osteotome ..... 228, 236, 817  
 Rhoton-Type..... 278, 501, 818  
 Ragnell Retractor ..... 159, 638  
 Ragnell Undermining Scissors..... 29, 648  
 Randall Endometrial Biopsy Suction Curette  
 ..... 771  
 Randall Kidney Stone Forceps..... 757  
 Rankin Artery Forceps ..... 59

**Rasps**

Antrum ..... 608  
 Bone ..... 243, 245  
 Carb-Bite ..... 694-696  
 Diamond ..... 689  
 Nasal..... 245, 691-693  
 Plastic Surgery ..... 690-691

- Podiatry..... 251  
Rib..... 367
- Rectal**  
Clamp..... 454, 759  
Forceps..... 749-750  
Hook..... 753  
Probe..... 753  
Retractor..... 746-747, 749,  
..... 756-757  
Speculum..... 746-747  
Reiner Rongeur..... 213, 577  
Renal Artery Clamp..... 451
- Retractors**  
Abdominal..... 169, 185-191  
Alar..... 635  
Anal..... 746-747  
Aortic..... 347  
Automatic Skin..... 178, 640  
Blades..... 186-187,  
..... 189-190,  
..... 336-339, 642,  
..... 714-715, 717  
Bone..... 208-209, 211,  
..... 245  
Cerebellar..... 182, 331  
Cervical..... 339  
Cheek..... 716, 744  
Cobra..... 209  
Crile..... 164  
Decompression..... 324  
Dissectomy..... 341  
Endural..... 591  
Epicardial..... 347  
Finger..... 157-160,  
..... 636-638  
Flexible Shaft..... 157  
Hand..... 159, 161-174,  
..... 208, 210,  
..... 637-639, 764,  
..... 800  
Hysterectomy..... 766  
Knee..... 207  
Knife Guide..... 633  
Lacrimal Sac..... 511  
Laminectomy..... 184, 332, 338  
Lid..... 511-512  
Lung..... 346, 348  
Nasal..... 635-636, 651  
Nerve..... 324-325  
Neurosurgery..... 329, 335, 590  
Orbital..... 512, 716  
Pillar..... 719  
Plastic Surgery..... 633-634
- Popliteal..... 195, 349  
Prostatic..... 756  
Rake..... 158, 160,  
..... 175-177, 210,  
..... 633, 638-639  
Rectal..... 749  
Renal Sinus..... 757  
Scalp..... 329  
Scalpula..... 346  
Self Retaining..... 178-179, 181-196,  
..... 329-331, 333,  
..... 335, 348, 452,  
..... 590-591,  
..... 639-641  
Shallow..... 192  
Skin Hook..... 158, 637  
Spinal..... 335  
Spring..... 180, 429  
Sternal..... 355-358  
Thymus..... 728  
Thyroid..... 163-164, 182,  
..... 332  
Tibia..... 207  
Tracheal..... 728  
Universal..... 766  
Uvula..... 701  
Vaginal..... 764-766  
Vagotomy..... 174  
Valve..... 346  
Vascular..... 195-196, 349  
Vein..... 164, 324, 800  
Wire..... 180, 640  
Reul Coronary Tissue Forceps..... 114, 387  
Reverse Curve Adenoid Curette..... 700  
Reynolds Clamp..... 442, 473  
Reynolds Scissors..... 10, 373  
Reynolds, Petit Point Scissors..... 47, 374-375, 668
- Rhoton-Type**  
Ball-Dissector..... 277-278, 501  
Curette..... 277, 501  
Dissector..... 275, 500  
Elevator..... 275, 500  
Forceps..... 264, 278, 398  
Hook..... 276, 500  
Instrument Rack..... 278, 501, 818  
Needle..... 276, 500  
Spatula-Dissector..... 275-276, 500  
Suture Tying..... 264, 398
- Rib**  
Contractor..... 359  
Periosteotome..... 367  
Rongeur..... 219, 366  
Shears..... 362-363

Spreader.....	353
Stripper .....	367
Ribbon Retractor.....	173
Richards Micro Needle Holder .....	493
Richardson Appendectomy Retractor ....	167
Richardson Retractor .....	166
Richardson-Eastman Retractor.....	165
Richter-Heath Clip Forceps.....	97
Rigby Retractor .....	183
<b>Ring</b>	
Curettes.....	226
Cutter .....	154
Laparotomy .....	152
Retractor Blade .....	717
Robb Tonsil Knife.....	720
Rochester-Carmalt Forceps.....	62
Rochester-Ochsner Artery Forceps.....	61, 786, 795
Rochester-Pean Artery Forceps .....	60, 410, 785,
.....	798
Roeder Towel Forceps .....	65
Roger Elevator.....	612
Rogers Hysterectomy Clamp .....	783
Rollet Retractor .....	158, 637
<b>Rongeurs</b>	
Bone .....	212-219, 221,
.....	365-366,
.....	576-579
Cervical .....	290-291
Cranial.....	299
Dental.....	743
Intervertebral Disc.....	296-298
Mastoid.....	575
Microsurgical .....	288-289, 303
Mini Bone .....	215, 364
Neuro .....	293, 296, 299
Pituitary .....	294-295
Rib.....	219, 366
Spurling .....	291-293
Thoracic.....	219, 366
Valve .....	428
Ronis Adenoid Punch.....	701
Root Tip Dental Elevator .....	737
Rosen Suction Tube.....	584
Ross Aortic Valve Retractor .....	347
Rosser Crypt Hook.....	753
Roux Retractor .....	161
Rowland-Ruskin-Liston Bone Splitting Forceps	
.....	625
Rubin Osteotome .....	645
Rubin Spetum Morselizer .....	626
Rubio Sternal Needle Holder .....	93, 419
Ruedemann Lacrimal Dilator .....	561
Rummel Artery Forceps.....	410

Rummel Tourniquet .....	411
Ruskin Angular Duckbill Rongeur .....	217, 365
Ruskin Antrum Trocar Needle.....	607
Ruskin Mini Bone Rongeur.....	215, 364
Ruskin Rongeur.....	216, 365, 579
Ruskin-Jay Rongeur .....	216, 365
Ruskin-Liston Bone Cutting Forceps .....	220
Ruskin-Liston Bone Splitting Forceps.....	220, 364
Russian Tissue Forceps .....	111, 386, 796
Ryder Needle Holder.....	87, 414, 494
Saalfeld Comedone Extractor .....	154
Sachs Dura Hook .....	315
Sachs Separator .....	318
Sachs Vein Retractor .....	324
Safety Blade Remover .....	68
Sage Tonsil Snare.....	723
Sarot Artery Forceps .....	406, 797
Sarot Bronchus Clamp .....	411, 453
Sarot Needle Holder.....	80, 90, 417
Satinsky Vascular Scissors .....	17, 375
Satinsky Vena Cava Clamp .....	441-442
Satterlee Saw.....	244
Sauer Eye Speculum, Infant .....	508
Sauer Suture Forceps .....	537
Sauerbruch Retractor .....	165
Sauerbruch Rib Rongeur .....	219, 366
Sauerbruch Rib Shears.....	362

<b>Saws</b>	
Bone .....	244
Metacarpal .....	245
Nasal.....	689
Sawyer Rectal Retractor.....	749
Sayre Elevator.....	242
Scalp Retractor.....	329
Schaaf Foreign Body Forceps .....	537
Schamberg Comedone Extractor .....	154
Schepens Orbital Retractor .....	512
Shink Metatarsal Spreader.....	253
Schlesinger Rongeur .....	296
Schmeden (Meltzer) Adenoid Punch.....	700
Schmidt Tonsil Forceps .....	480, 719
Schroeder Tenaculum Forceps.....	776
Schroeder Uterine Vulsellum Forceps ....	778
Schubert Biopsy Forceps .....	773

<b>Scissors</b>	
Abdominal .....	6-7, 788
Alligator .....	588, 707
Arteriotomy .....	382
Bandage .....	11-12, 200-201
Bone .....	30, 164, 650
Capsulotomy .....	557
Carb-Edge.....	36-40, 52, 344,



- ..... 369, 371,  
..... 373-374, 550,  
..... 552, 661-663,  
..... 722, 772, 779,  
..... 788, 794  
Cartilage ..... 14, 246  
Circumflex Artery ..... 20, 380  
Conjunctival ..... 23, 551, 657  
Cord ..... 790  
Corneal ..... 556-557  
Corneal Transplant ..... 558  
Coronary Artery ..... 20-21, 49,  
..... 379-381  
Cuticle ..... 156  
Dissecting ..... 6, 17, 31, 33, 375,  
..... 650, 653  
Dorsal ..... 29-30, 46, 649,  
..... 668  
Dura ..... 15, 344  
Endarterectomy ..... 18, 48, 376  
Enucleation ..... 26, 554  
Episiotomy ..... 35, 788  
Face Lift ..... 44-45, 665-667  
Fistula ..... 9, 754  
Flat Tip ..... 9, 375, 654  
Gall Bladder ..... 14, 145  
Ganglion ..... 15, 344  
Gum ..... 33, 653, 744  
In-Situ Valve ..... 21, 381  
Iris ..... 22-24, 40, 43,  
..... 549-551, 556,  
..... 558, 656-658,  
..... 663-664  
Lateral ..... 46, 668  
Leaflet ..... 382  
Lower Lateral ..... 29, 648  
Micro ..... 268-269,  
..... 382-384  
Micro Ear ..... 568  
Microlaryngeal ..... 727  
Microsurgery ..... 265, 267-268,  
..... 303, 377  
Middle Ear ..... 588, 592  
Nail ..... 156  
Nail Splitting ..... 252  
Nasal ..... 28, 31, 43, 605,  
..... 665, 703-704,  
..... 707  
Nasal Bone ..... 28, 32, 43, 651  
Neuro/Spinal ..... 15, 344  
Operating ..... 2-10, 38-40, 42,  
..... 47, 344, 369,  
..... 373-374, 605,  
..... 653-654,  
..... 661-664,  
..... 722, 788, 794  
Ophthalmic ..... 22-27, 40,  
..... 549-558,  
..... 656-660  
Petit-Point ..... 38, 47, 52,  
..... 374-375, 668  
Plastic and Recon ..... 10, 29-33,  
..... 45-46, 48,  
..... 665-666, 668  
Platysma ..... 45, 667  
Removal ..... 26, 554  
Reynolds ..... 38, 47, 52, 662  
Rhytidectomy ..... 45, 667  
Saber Back ..... 31, 651  
Septum ..... 30-32, 649-650,  
..... 652  
Stitch ..... 13, 26-27, 99,  
..... 554-555, 660  
Supercut ..... 41-49, 51, 344,  
..... 369, 371-376,  
..... 378, 380-381,  
..... 550, 605,  
..... 664-668, 722,  
..... 788, 794  
Suture ..... 12-14, 27, 33, 40,  
..... 98-99, 553-555,  
..... 652, 655,  
..... 659-660, 665  
Tenotomy ..... 25, 43, 48, 553,  
..... 659, 665  
Thoracic ..... 16, 39, 369-371,  
..... 382, 788  
Tonsil ..... 34, 721  
Trigeminal ..... 15, 344  
Turbinate ..... 28, 32, 605, 652  
Undermining ..... 29, 648  
Uterine ..... 35, 779, 787-788  
Utility ..... 24, 552-553,  
..... 659  
Vannas ..... 558  
Vascular ..... 7, 16-21, 48-49,  
..... 370, 372,  
..... 375-379, 381  
Vein Graft ..... 592  
Wire ..... 12, 14, 40, 99  
Scleral Twist Fixation Hook ..... 520
- Scops**  
Gall Stone ..... 141  
Scoville Bipolar Forceps ..... 122-123, 313-314  
Scoville Blade ..... 336-337  
Scoville Disc Curettes ..... 225  
Scoville Nerve Retractor ..... 325  
Scoville Retractor Frame ..... 336  
Scoville Spatulas ..... 328

Sedillot Elevator..... 242  
 Seiler Turbinate Scissors..... 28, 605  
 Seldin Elevator ..... 737  
 Seldin Periosteal Elevator ..... 242, 580  
 Seletz-Gelpi Retractor..... 335  
 Self-Centering Bone Forceps ..... 205  
 Selman Peripheral Forceps ..... 458  
 Selman Tissue Forceps..... 115, 386  
 Semb Ligature Carrier ..... 411  
 Semb Lung Retractor ..... 348  
 Semb Retractor ..... 167  
 Semken Bipolar Forceps ..... 311  
 Semken Dressing Forceps ..... 107, 305, 686  
 Semken Needle Pulling Forceps ..... 96, 394, 688  
 Semken Tissue Forceps..... 108, 306, 686  
 Semmes (Howard) Spinal Curette ..... 224  
 Senn Retractor ..... 157, 636

**Separators**

Dura ..... 317-318, 323

**Septum**

Elevator ..... 611, 613, 704  
 Forceps ..... 621-624  
 Morselizer ..... 626  
 Needle..... 711  
 Scissors ..... 30-32,  
 ..... 649-650, 652  
 Speculum..... 602, 703  
 Serrefine Forceps ..... 427  
 Sesamoidectomy Clamp..... 248  
 Seton Retractor Blade ..... 193  
 Seton Shallow Surgical Retractor..... 192

**Sets**

Coronary Artery Bypass ..... 422  
 Cranial Drill..... 342  
 Dermal Punch ..... 155  
 Initial Incision Retractor ..... 210  
 McGiveny Ligator ..... 751  
 Mini Osteotome ..... 236  
 Stone Intestinal Clamp ..... 136  
 Vein Stripper ..... 146, 430  
 Vertebral Biopsy..... 300  
 Sewall Orbital Retractor ..... 716  
 Sexton (Gerzog) Ear Knife..... 573  
 Shambaugh Adenotome ..... 698  
 Shapleigh Ear Curette ..... 571  
 Shea Vein Graft Scissors ..... 592  
 Shearer Chicken Bill Rongeur ..... 213, 576

**Shears**

Plaster ..... 200-201  
 Rib..... 362-363  
 Utility..... 200

Sheehy Fascia Press ..... 599  
 Sheehy Ossicle Holding Clamp ..... 599  
 Sheets-McPherson Tying Forceps..... 539  
 Shepard Iris Hook ..... 516  
 Shepard Tying Forceps ..... 540  
 Silver Osteotome..... 644  
 Simcoe Nucleus Loop ..... 523  
 Simpson Obstetrical Forceps ..... 790-791  
 Simpson Uterine Sound ..... 769  
 Simpson-Luikhart Obstetrical Forceps... 792  
 Sims Rectal Speculum..... 746  
 Sims Uterine Curette..... 770  
 Sims Uterine Scissors..... 35, 787  
 Sims Uterine Sound ..... 768  
 Sims Vaginal Retractor ..... 765-766  
 Singley Tissue Forceps ..... 115, 386, 796  
 Sinoscopy Trocar and Cannula ..... 712

**Sinus**

Cannula..... 607  
 Curette ..... 618  
 Forceps..... 707-708  
 Ostium Seeker ..... 711  
 Punch ..... 709

**Sinusscopes**

Sinus Endoscopy ..... 712  
 Tray ..... 712, 822  
 Sinskey Iris Hook ..... 518  
 Sinskey Tying Forceps ..... 539  
 Sinus Septum Needle ..... 711  
 Sinus Sickle Knife ..... 711  
 Sinuscope, Autoclavable ..... 712  
 Sistrunk Retractor..... 162  
 Sistrunk Scissors..... 5  
 Skene Tenaculum Forceps ..... 777

**Skids**

Bone ..... 208  
 Hip ..... 208

**Skin**

Hook..... 518, 630-631  
 Skinner Needle Pulling Forceps..... 96, 395  
 Slip Joint Utility Pliers ..... 260  
 Sluder-Jansen Mouth Gag..... 714  
 Small Snap-On Basket Tag (with Key Ring)  
 ..... 810  
 Smillie Meniscus Knife..... 246  
 Smillie Retractor ..... 208  
 Smith Anal Retractor ..... 747  
 Smith Wire Scissors..... 14, 99  
 Smith-Petersen Gouge ..... 231  
 Smith-Petersen Osteotome Rack..... 228, 817  
 Smith-Petersen Osteotome ..... 231



- Smith-Petersen Rongeur ..... 219  
 Smithwick Sympathectomy Hook ..... 317, 368
- Snares**  
 Ear ..... 570  
 Nasal ..... 606  
 Tonsil ..... 723  
 Snellen Entropium Forceps ..... 544  
 Solutions Basin ..... 815  
 Somers Uterine Elevating Forceps ..... 769  
 Sonnenschein Nasal Speculum ..... 600
- Sounds**  
 Urethral ..... 760  
 Uterine ..... 769
- Spatulas**  
 Cement ..... 734  
 Cyclodialysis ..... 521-522  
 Endarterectomy ..... 429  
 Iris ..... 520-522  
 Lens Nucleus ..... 520  
 Neuro ..... 328  
 Platinum ..... 521  
 Rhoton-Type ..... 275-276, 500  
 Vaginal ..... 763
- Specula**  
 Anal ..... 747  
 Ear ..... 564-565  
 Endocervical ..... 769  
 Eye ..... 508-510  
 Nasal ..... 600-601, 703  
 Operating ..... 747  
 Proctoscope ..... 748  
 Rectal ..... 746-748  
 Septum ..... 601-602, 703  
 Synechia ..... 522  
 Vaginal ..... 762-763  
 Spencer Suture Scissors ..... 13, 98-99
- Spinal**  
 Blades ..... 338  
 Curette ..... 223-224  
 Retractor ..... 335  
 Spinal Fusion Curette ..... 223
- Spreaders**  
 Cast ..... 201  
 Cervical ..... 334  
 Interbody ..... 341  
 Lamina ..... 333-334, 341  
 Metatarsal ..... 253  
 Pylorus ..... 131  
 Rib ..... 350-355, 499
- Vertebra ..... 340  
 Spring Wire Retractor ..... 180, 640
- Spuds**  
 Foreign Body ..... 514-515  
 Spurling Pituitary Rongeur ..... 295
- Stardust**  
 Forceps ..... 279-286, 493,  
 ..... 496-497,  
 ..... 502-505,  
 Micro Forceps ..... 284  
 Needle Holder ..... 279-280, 282,  
 ..... 418, 493,  
 ..... 496-497, 502  
 Rasp ..... 689  
 Ring Forceps ..... 285, 503  
 Suture Forceps ..... 284, 286, 505  
 Staude-Moore Tenaculum Forceps ..... 776  
 Steel Ruler ..... 559
- Steelware**  
 Basin ..... 815  
 Steiner-Auvard Vaginal Speculum ..... 763  
 Sterile Indicator Card ..... 809
- Sterilization Containers** ..... See Containers  
 Sterilization Filter ..... 809  
 Sternal Chest Tube Passer ..... 478
- Sternal**  
 Needle Holder ..... 93, 256, 420  
 Passer ..... 478  
 Stevens Removal Scissors ..... 26, 554  
 Stevens Stitch Scissors ..... 26, 554, 660  
 Stevens Tenotomy Hook ..... 517  
 Stevens Tenotomy Scissors ..... 25, 43, 48, 553,  
 ..... 659-660, 665  
 Stevenson Lacrimal Sac Retractor ..... 511  
 Stewart Crypt Hook ..... 753  
 Stille Plaster Shears ..... 201  
 Stille Vessel Clamp ..... 453, 758  
 Stille-Giertz Rib Shears ..... 362  
 Stille-Horsley Bone Cutting Forceps ..... 221, 364  
 Stille-Liston Bone Cutting Forceps ..... 221, 364  
 Stille-Luer Rongeur ..... 217, 365  
 Stille-Luer-Echlin Rongeur ..... 218, 366  
 Stille-Type Chisel ..... 235  
 Stille-Type Gouge ..... 235  
 Stille-Type Osteotome ..... 235  
 Stitch Scissors ..... 27, 555, 660  
 Stone Clamp Applying Forceps ..... 135  
 Stone Clamp Locking Device ..... 135  
 Stone Intestinal Clamp ..... 135  
 Stone Intestinal Clamp Set ..... 136

Stoney Heparin Injector ..... 423  
 Stookey Cranial Rongeur ..... 299  
 Stopcock ..... 422  
 Storey Artery Forceps ..... 64, 404  
 Strabismus Scissors ..... 25, 40, 552,  
 ..... 659, 663  
 Stratte Needle Holder ..... 90, 417  
 Struempel Alligator Ear Forceps ..... 567  
 Struempel Pediatric Forceps ..... 705  
 Struempel-Voss Nasal Forceps ..... 621  
 Strully Dura Twist Hook ..... 316  
 Strully Scissors ..... 15, 344  
 Struycken Nasal Cutting Forceps ..... 707  
 Stubbs Adenoid Curette ..... 699  
 Subramanian Miniature Aorta Clamp ..... 471

**Suction**  
 Abdominal ..... 147-149  
 Cannula ..... 711  
 Dental ..... 149  
 Ear ..... 327, 585-586  
 General ..... 147-149, 724  
 Neuro ..... 327  
 Rectal ..... 427  
 Tube ..... 147-149, 326,  
 ..... 584, 586,  
 ..... 702, 724, 800  
 Vascular ..... 421

**Supercut**  
 Scissors ..... 41-49, 51, 344,  
 ..... 369, 371-376,  
 ..... 378, 380-381,  
 ..... 550, 605,  
 ..... 664-668, 722,  
 ..... 788, 794  
 Suraci Zygoma Hook-Elevator ..... 632

**Suture**  
 Forceps ..... 264, 398, 479,  
 ..... 530-532,  
 ..... 535-537,  
 ..... 539-540  
 Scissors ..... 12-14, 27, 33, 40,  
 ..... 98-99,  
 ..... 553-555, 652,  
 ..... 655, 659-660,  
 ..... 665  
 Sweet Amputation Retractor ..... 245

**Syringes**  
 Aspirating ..... 744  
 Ear ..... 583  
 Takahashi Nasal Forceps ..... 624, 707  
 Takahashi Rongeur ..... 298

Takahashi Suction Forceps ..... 708  
 Tamper Evident Lock ..... 809  
 Taylor Dura Scissors ..... 15, 344  
 Taylor Laminectomy Blade ..... 338  
 Taylor Percussion Hammer ..... 151  
 Taylor Retractor ..... 335  
 Taylor Spinal Blade ..... 338  
 Teale Uterine Vulsellum Forceps ..... 778

**Tenaculum**  
 Forceps ..... 776-777  
 Hook ..... 632  
 Tendon Braiding Forceps ..... 249  
 Thomas Uterine Curette ..... 770  
 Thomas-Gaylor Biopsy Forceps ..... 772  
 Thompson Carotid Closure Clamp ..... 470  
 Thoms-Allis Tissue Forceps ..... 128

**Thoracic**  
 Clamp ..... 146, 406,  
 ..... 410-411, 443,  
 ..... 445, 449, 453  
 Dilator ..... 428  
 Dissector ..... 427  
 Forceps ..... 109-110, 387,  
 ..... 402, 404-405,  
 ..... 407-409, 456  
 Needle Holder ..... 90, 418  
 Rongeur ..... 219, 366  
 Scissors ..... 16, 39, 369-371,  
 ..... 382, 788  
 Thorek Gall Bladder Scissors ..... 14, 145  
 Thornton Intraocular Lens Forceps ..... 542  
 Thorpe Caliper ..... 559  
 Thorpe Conjunctival Fixation Forceps ..... 528

**Thumb**  
 Forceps ..... 100-120,  
 ..... 304-307,  
 ..... 309-310,  
 ..... 388-389, 391,  
 ..... 525, 683-684,  
 ..... 686, 723, 725,  
 ..... 775, 795  
 Tiek-Halle Nasal Speculum ..... 600, 703  
 Tischler Biopsy Forceps ..... 774  
 Tissue and Cuticle Nipper ..... 252

**Tissue**  
 Forceps ..... 54, 100-115,  
 ..... 117-118, 126-130,  
 ..... 304-309,  
 ..... 385-391,  
 ..... 396-397,  
 ..... 401-402, 495,

..... 498, 504,  
 ..... 681-687,  
 ..... 796-797  
 Tissue Nipper ..... 253  
 Tivnen Tonsil Seizing Forceps ..... 718  
 Toffmire Type Matrix Retainer ..... 744

**Tongue**

Blade ..... 642, 714  
 Depressor ..... 717  
 Forceps ..... 150

**Tonsil**

Dissector ..... 720  
 Forceps ..... 480, 718-719  
 Knife ..... 720  
 Scissors ..... 34, 721  
 Snare ..... 723  
 Tooke Corneal Knife ..... 512  
 Townley Femur Caliper ..... 262  
 Townsend Endocervical Biopsy Curette ..... 772  
 Toynebee Ear Specula ..... 565

**Tracheal**

Dilator ..... 727  
 Hemostat ..... 729  
 Retractor ..... 728

**Trays**

Instrument ..... 811  
 Perforated ..... 811-812  
 Sinuscope ..... 712, 822

**Trocars**

Antrum ..... 607  
 Trousseau Tracheal Dilator ..... 727  
 Troutman Needle Holder ..... 548  
 Troutman Superior Rectus Forceps ..... 545  
 Troutman-Barraquer Utility Forceps ..... 530, 536  
 Troutman-Castroviejo Corneal Section Scissors  
 ..... 557  
 Tubbs Dilator ..... 428  
 Tube Occluding Forceps ..... 68, 481  
 Tube Occluding Forceps w/U-Shaped Guard  
 ..... 69

**Tubes**

Forceps ..... 68-69, 481  
 Suction ..... 147-149,  
 ..... 326-327, 421,  
 ..... 584-586, 702,  
 ..... 724, 752, 800  
 Tracheal ..... 729-730  
 Tuffier Rib Spreader ..... 353

**Tumor**

Screw ..... 784

**Tuning**

Fork ..... 569

**Tunnelers**

Femoral Bypass ..... 431  
 Graft ..... 430  
 Turrell Biopsy Forceps ..... 749-750  
 Tydings Tonsil Snare ..... 723  
 Tyrell Hook ..... 516  
 U of M Cheek Retractor ..... 744  
 Uebe Applicator ..... 583  
 Ulrich-Style Bone Holding Forceps ..... 206  
 Umbilical Cord Scissors ..... 790  
 Universal Bandage Scissors ..... 12, 200-201  
 Universal Hand Drill ..... 255  
 Universal Wire Suture Scissors ..... 12, 40, 98  
 University of Illinois Bone Marrow Biopsy Needle  
 ..... 151  
 Unna Comedone Extractor ..... 154

**Urology**

Retractors ..... 756  
 Urethrotome ..... 755  
 US Army Retractor ..... 161

**Uterine**

Curette ..... 770, 772  
 Dilator ..... 767-768  
 Forceps ..... 769, 772,  
 ..... 774-776, 778,  
 ..... 787  
 Scissors ..... 35, 779, 787-788  
 Uvula Retractor ..... 701  
 Valve Leaflet Scissors ..... 382  
 Van Alyea Frontal Sinus Cannula ..... 607  
 Van Buren Urethral Sound ..... 760  
 Vanderbilt Clamp ..... 406  
 Vannas Capsulotomy Scissors ..... 557  
 Varco Gallbladder Forceps ..... 144

**Vascular**

Adaptor ..... 423  
 Cannula ..... 423  
 Clamp ..... 133, 434-452,  
 ..... 458-460,  
 ..... 465-475, 479,  
 ..... 481-486, 492  
 Dilator ..... 425-426, 820  
 Forceps ..... 95, 102-103,  
 ..... 109, 264, 305,  
 ..... 385, 393-394,  
 ..... 396-397, 402,

..... 406, 410,  
 ..... 456-458,  
 ..... 476-477, 495,  
 ..... 498, 797  
 Ligature Carrier ..... 411  
 Needle Holder ..... 89-95, 256,  
 ..... 415-416, 420  
 Retractor ..... 196, 346-347,  
 ..... 349, 357-358  
 Scissors ..... 7, 16-21, 48-49,  
 ..... 370, 372,  
 ..... 375-379, 381  
 Shunt ..... 482  
 Suction Tube ..... 421  
 Tunneler ..... 431

**Vein**

Retractor ..... 164, 324, 800  
 Scissors ..... 592  
 Stripper ..... 146  
 Verbrugge Bone Holding Clamp ..... 205  
 Vertical Retractor ..... 211  
 Vienna Nasal Specula ..... 600-601  
 Virtus Splinter Forceps ..... 125  
 Vogel Adenoid Curette ..... 699  
 Volkman Bone Curette ..... 225  
 Volkman Retractor ..... 160, 175-176  
 Von Eicken Suction Cannula ..... 711  
 Von Graefe Fixation Forceps ..... 528  
 Von Graefe Iris Forceps ..... 526-527  
 Von Graefe Strabismus Hook ..... 517  
 Von Graefe Tissue Forceps ..... 101  
 Vorse Tube Occluding Forceps ..... 68, 481  
 Wachtenfeld Clip Forceps ..... 97  
 Wall Wax Carver, Double Ended ..... 733  
 Walsham Septum Forceps ..... 624  
 Walton Cartilage Clamp ..... 247  
 Walton Cast Spreader ..... 201  
 Walton Meniscus Clamp ..... 247  
 Walton-Liston Bone Cutting Forceps ..... 220  
 Wangenstein Tissue Forceps ..... 115, 387  
 Ward Wax Carver, Double Ended ..... 733  
 Wartenberg Pin Wheel ..... 151  
 Watson-Williams Polypus Forceps ..... 619  
 Watzke Sleeve Spreading Forceps ..... 537  
 Wax Spatula, small end with one flat side  
 ..... 734  
 Webster Needle Holder ..... 78, 84, 412,  
 ..... 671, 674  
 Wecker Iris Spatula ..... 521  
 Weil Nasal Forceps ..... 621  
 Weinberg Vagotomy Retractor ..... 174  
 Weinstein Instrument Holder ..... 812  
 Weisenbach Forcep Holder ..... 814  
 Weitlaner Retractor ..... 181-182,

..... 330-331, 591,  
 ..... 641  
 Weldon Miniature Bulldog Clamp ..... 485  
 Wells Enucleation Spoon ..... 524  
 Wertheim Pedicle Clamp ..... 454, 759  
 Wertheim-Cullen Pedicle Clamp ..... 454, 759  
 West Lacrimal Sac Chisel ..... 609  
 West Lacrimal Sac Gouge ..... 609  
 Westcott Stitch Scissors ..... 554  
 Westcott Tenotomy Scissors ..... 553  
 Westcott Utility Scissors ..... 553  
 Wheeler Cyclodialysis Spatula ..... 521  
 Wheeler Discission Knife ..... 512  
 Wheeler-Type Plaque and Vessel Forceps  
 ..... 109, 387  
 White Tonsil Seizing Forceps ..... 718  
 Wieder Tongue Depressor ..... 717  
 Wiener Antrum Rasp ..... 608  
 Wiener Eye Speculum ..... 509  
 Wiener Skin Hook ..... 630  
 Wilde Ear Dressing Forceps ..... 119, 566  
 Wilde Nasal Dressing Forceps ..... 120, 603  
 Wilde Nasal Forceps ..... 620  
 Wilde Rongeur ..... 297  
 Wilder Lacrimal Dilator ..... 560  
 Wilder Lens Loop ..... 523  
 Willauer Scissors ..... 16, 370  
 Willauer-Deaver Retractor ..... 174  
 Williams Discectomy Retractor ..... 341  
 Williams Eye Specula ..... 509  
 Williams Lacrimal Probe ..... 560  
 Williams Splinter Forceps ..... 125  
 Williams Tissue Forceps ..... 129  
 Williams-Type Discectomy Forceps ..... 303  
 Williger Bone Curette ..... 250  
 Wills Hospital Utility Forceps ..... 535  
 Wilmer Conjunctival Scissors ..... 23, 551, 657

**Wire**

Brush ..... 693  
 Cut Snare ..... 723  
 Cutter ..... 258  
 Mandrin ..... 149  
 Passer ..... 642  
 Pulling Forceps ..... 256  
 Retractor ..... 180, 640  
 Scissors ..... 12, 14, 40, 99  
 Twister ..... 93, 256, 420  
 Wittner Biopsy Forceps ..... 772  
 Wolfe-Boehler Cast Breaker ..... 201  
 Woodson Dura Separator and Packer ..... 323  
 Woodson Elevator and Spatula ..... 322  
 Woodson Plastic Filling Instrument ..... 734  
 Woodward Artery Forceps ..... 405  
 Worst "Pigtail" Probe ..... 561



Wright-Rubin Septum Morselizer .....	626	Yasargil Needle Holder.....	267
Wullstein Retractor.....	591	Yasargil Scissors .....	267, 377
Wylie “J” Clamp.....	439	Yeoman Biopsy Forceps .....	749-750
Wylie Abdominal Aorta Clamp .....	435	Young Prostatic Retractor.....	756
Wylie Hypogastric Clamp.....	435	Young Tongue Seizing Forceps .....	150
Yankauer Suction Tube .....	148-149, 724,	You-Potts Scissors .....	377
.....	800	Zanger Abdominal Aorta Clamp.....	435
Yasargil Forceps.....	267	Ziegler Cilia Forceps.....	541
Yasargil Instrument.....	271-272	Zipser Penis Clamp.....	790
Yasargil Ligature Carrier.....	274	Z-Hysterectomy Forceps .....	780

900

INCHES

MILLIMETERS

10

250

240

230

220

210

200

190

180

170

160

150

140

130

120

110

100

90

80

70

60

50

40

30

20

10

9

8

7

6

5

4

3

2

1





**Integra™**  
Surgical Instrument  
Product Lines

## Integra™ Omni-Tract® Table Mounted Retractors

Integra™ Surgical Table Mounted Retractors, formerly known as Omni-Tract®, provides you with both Wishbone® and Ring Retractor Systems.

- Wishbone® Retractor Systems offer a multi-use frame perfect for varied patient, or incision size
- The Integra™ Ring Retractor system is interchangeable with all marketed Ring Retractor Systems

Limit uncertainty with strength and adjustability!

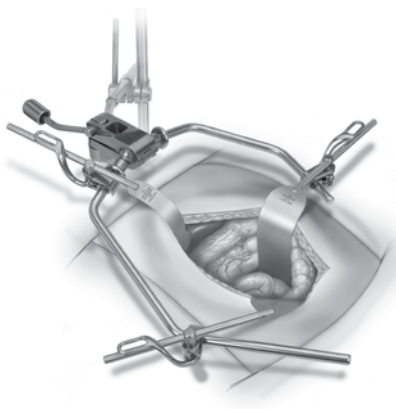

Wishbone® Style



Ring Style

For more information or to place an order, please contact:  
Integra ■ 4849 White Bear Parkway, St. Paul, MN 55110  
800.367.8657 USA ■ 651.287.4300 outside USA  
651.287.4400 fax  
[integralife.com](http://integralife.com)

## Integra™ Padgett® Plastics Instruments

Integra™ Surgical Plastic Surgery Instruments represent one of the broadest offerings of specialty plastic surgery instruments available. Integra's plastic surgery instruments include instruments for a variety of reconstructive and cosmetic plastic procedures.

Limit uncertainty with a broad offering and exceptional quality!



For more information or to place an order, please contact:  
Integra ■ 589 Davies Drive, York, PA 17402  
877-468-5572 USA ■ 609-750-4259 fax  
914-592-9050 outside USA ■ 914-592-8056 outside USA fax  
[integralife.com](http://integralife.com)

## Integra™ Luxtec® Surgical Illumination

### Optimized System Performance

- 15% more light with MLX
- Cool running smart fans
- 1000 hour lamp
- Comfort, ease of use
- Maximum light with MLX/UL Pro System

**The ProXenon™ Surgical Illuminator and Headlight System** is a durable, user-friendly device that offers superior comfort, rapid lamp change, extended lamp life and superior lux.

Don't forget that Luxtec is the market leader in surgical illumination and can also provide instrument cables in various standard lengths!



**MLX Ultralite® Pro Headlight  
& Xenon Light Source**



**ProXenon™ Surgical Illuminator  
and Headlight System**

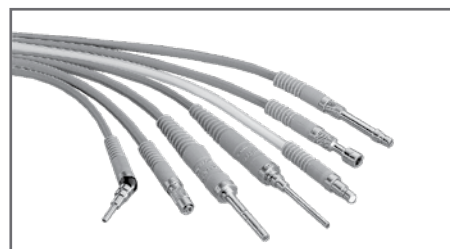

**Fiber Optic Instrument Cables**

For more information or to place an order, please contact:  
Integra ■ 589 Davies Drive, York, PA 17402  
877-468-5572 USA ■ 609-750-4259 fax  
914-592-9050 outside USA ■ 914-592-8056 outside USA fax  
[integralife.com](http://integralife.com)

## Integra™ Ruggles™-Redmond™ Neuro/Spine Instruments

Integra™ Surgical Neuro/Spine Instruments represent one of the broadest offerings of specialty Neuro/Spine instruments available. Integra's offerings include innovative features including detach Kerrison rongeurs and coating to extend the life of the instruments.

Limit uncertainty with a broad offering and exceptional quality!

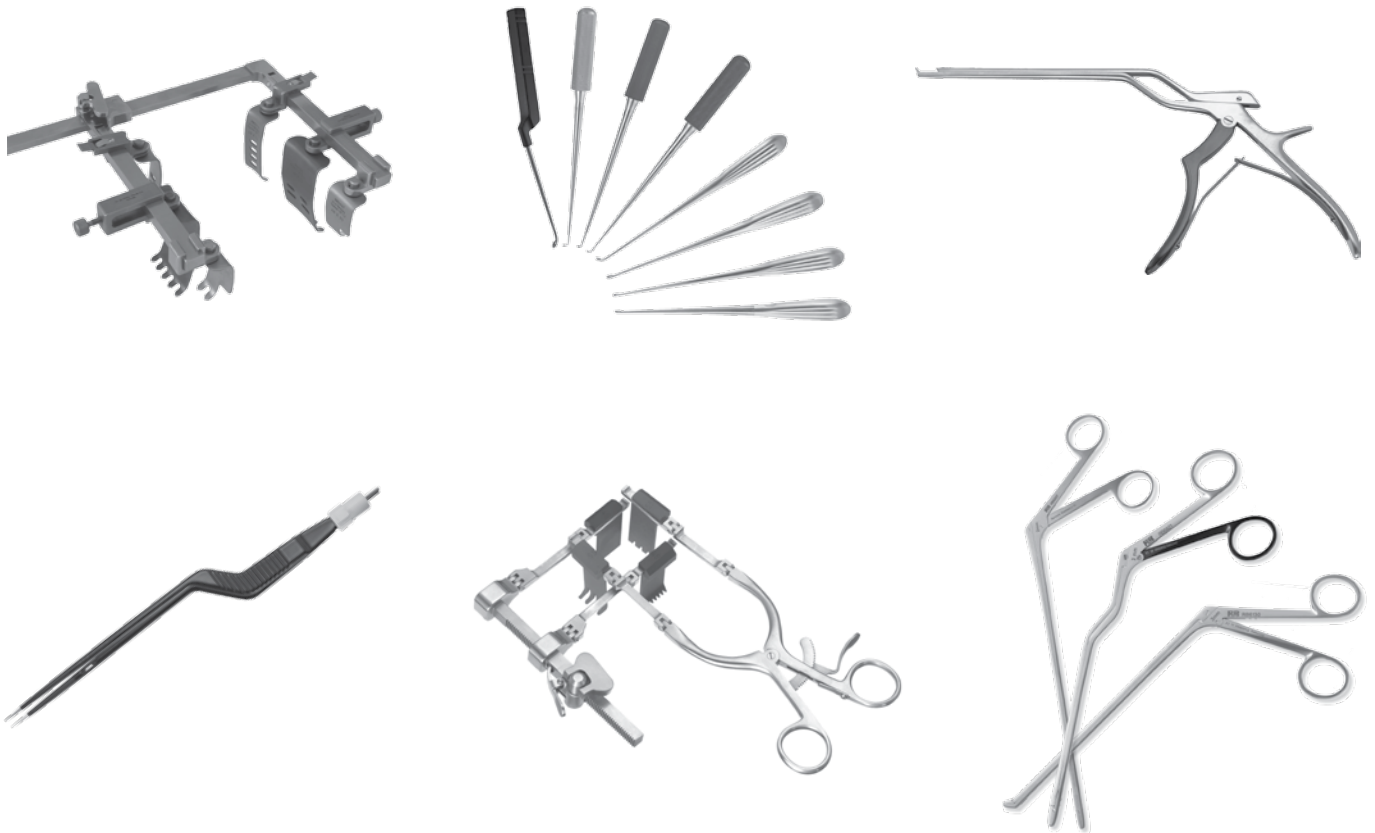

For more information or to place an order, please contact:  
Integra ■ 589 Davies Drive, York, PA 17402  
877-468-5572 USA ■ 609-750-4259 fax  
914-592-9050 outside USA ■ 914-592-8056 outside USA fax  
[integralife.com](http://integralife.com)

## Integra™ Jarit® Laparoscopic Instruments

### One-Piece Instruments

Polymer filling and silicone o-rings provide a barrier to bioburden.

Limit uncertainty with confidence and ease of use.



#### Hunter Bowl Grasper

Fenestrated, 20mm jaws with DeBakey-type teeth for atraumatic manipulation of delicate tissue (e.g. bowel, stomach), double action

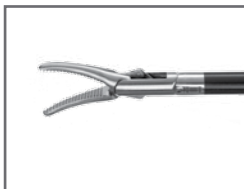

#### Maryland Dissector

Curved, tapered, serrated jaws with wide spread, double action

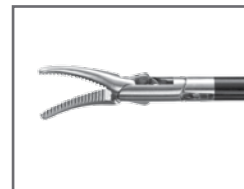

#### Tapered Maryland Dissector

Curved, finely-tapered, serrated jaws with wide spread, double action



#### Grasping Forceps

Straight, serrated jaws with proximal recess, double action



#### Tenaculum Forceps

Single-toothed long jaws designed for grasping of thick tissue, double action



#### Claw Forceps

2 x 3 interlocking teeth for penetrating hold and extracting tissue

For more information or to place an order, please contact:  
Integra ■ 589 Davies Drive, York, PA 17402  
877-468-5572 USA ■ 609-750-4259 fax  
914-592-9050 outside USA ■ 914-592-8056 outside USA fax  
[integralife.com](http://integralife.com)

## Limit Uncertainty with a smarter instrument management solution.

The Integra™ Instrument Management services provides the highest quality, most up-to-date inventory management program available. Our software makes direct access to complex instrument information as simple as a click of a button. The latest bar coding technology allows the real-time tracking of surgical sets and instruments. Our Integra™ Instrument Management consultants will work with you to facilitate the process and to enhance efficiencies realized with using data wisely. Integra wants to be your long-term source for instrument management.

### Our software can provide you with:

- **Electronic maintenance** of count sheet data
- **Cross-referencing** of instruments by various manufacturers
- **Touch screen technology** for easy Tray Assembly with instrument picture display
- **Automation** of sterilization documents and results
- **Scheduled preventative maintenance** and repair documentation
- **On-screen messaging, pictures and videos**
- **Individual Instrument Tracking** capabilities
- Instrument, tray, peel pack and loaner tray **tracking capabilities**
- **Traceability** of items to the patient level
- **Employee productivity** and educational statistics
- **Standard and custom** reports available

### Consulting Services:

#### Physical Inventory

We will perform a physical inventory of your surgical instruments, trays, and equipment, etc., as deemed necessary to assure accurate data at time of installation.

#### Database Build

Following the inventory, the data is reviewed by our consultants and entered into your new instrument database.

#### Implementation Services

We will provide software training to customer personnel over the course of several pre-determined visits to cover all aspects of software use and management.

#### Instrument Expansion/Conversion Product Support

The Integra team will be available to facilities needing assistance with instrument expansion/conversion projects such as physical inventories, set utilization, needs assessments and process flow studies. The Integra team will provide the additional support required to develop standardized trays, process orders, receive/unpack shipments and prepare new trays.



For more information or to place an order, please contact:  
 Integra ■ 589 Davies Drive, York, PA 17402  
 877-468-5572 USA ■ 609-750-4259 fax  
 914-592-9050 outside USA ■ 914-592-8056 outside USA fax  
[integralife.com](http://integralife.com)











For more information or to place an order, please contact:  
Integra ■ 589 Davies Drive, York, PA 17402  
877-468-5572 USA ■ 800-275-7192 fax  
914-789-7094 outside USA ■ 609-750-4218 outside USA fax  
[integralife.com](http://integralife.com)

